

POPULAR SCIENCE

MONTHLY

DEC. 1947
25 CENTS

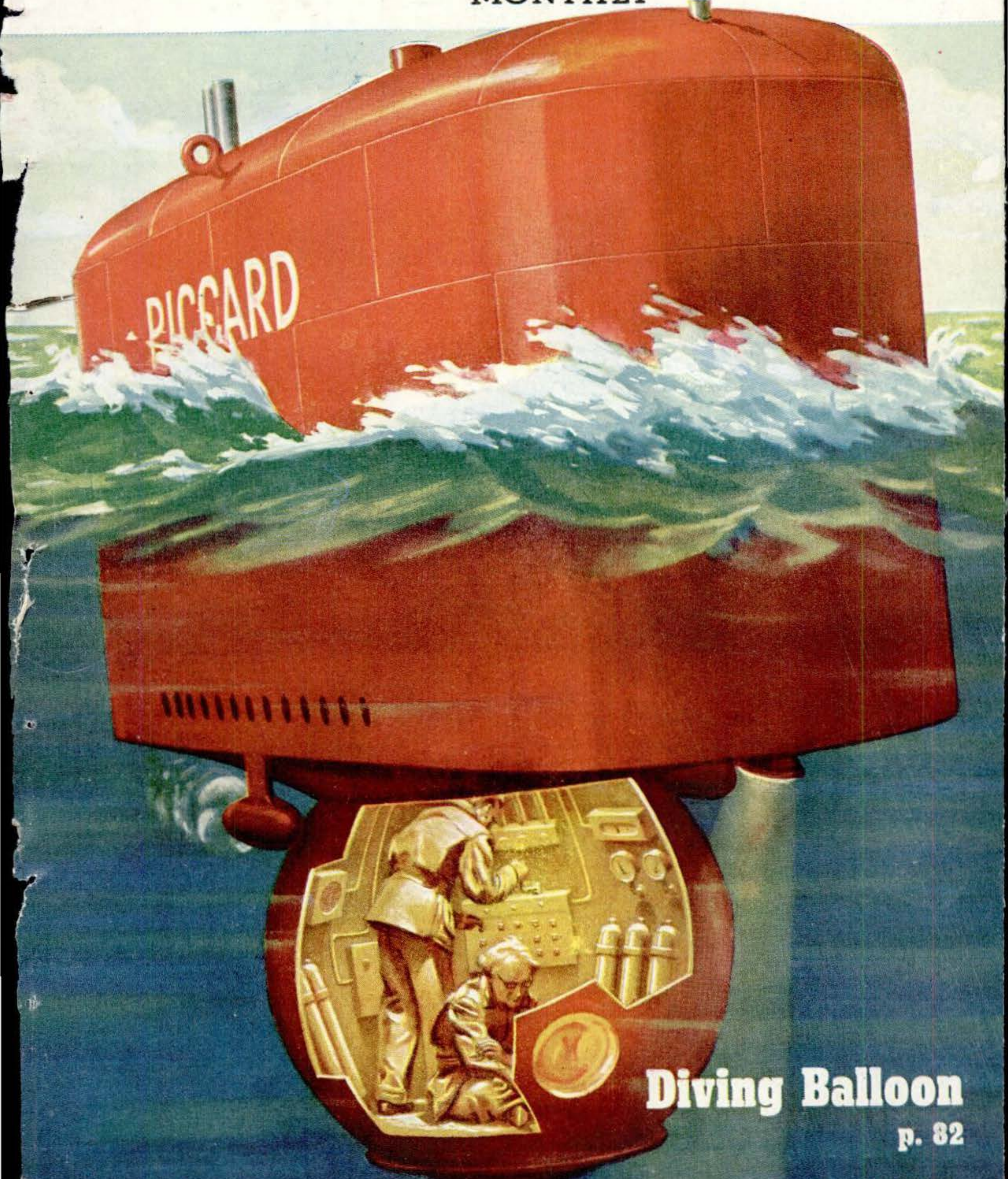

Diving Balloon

p. 82

Ray Fuchs

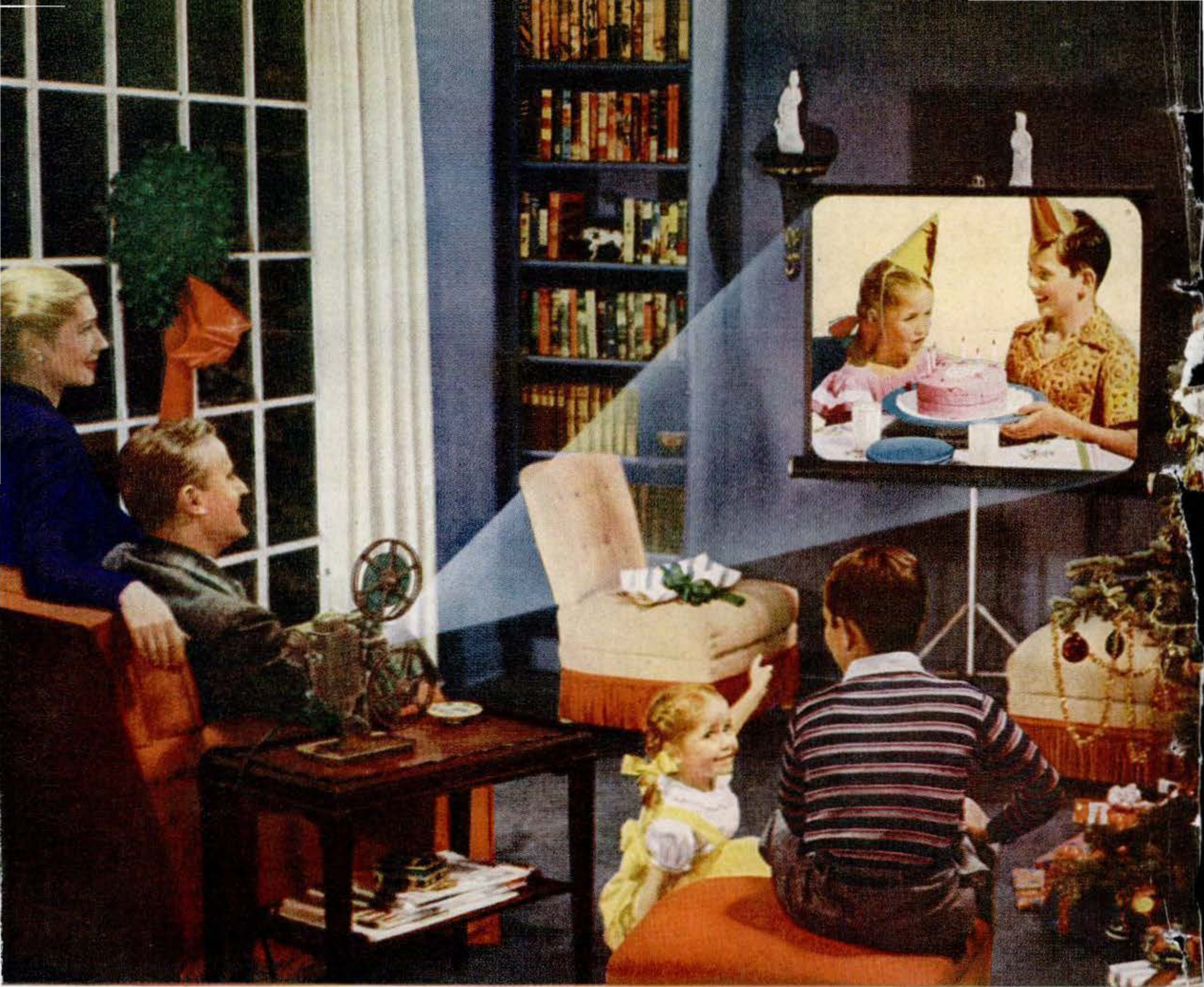

The gift of pleasure all will treasure...

Children are such natural home movie "stars"! What more priceless pleasure can you give than a permanent record of their precious talents, of all family-shared fun . . . filmed at Christmas time, birthdays, etc. . . . Movie-making with

Revere is so easy, a child can do it. So inexpensive, too, on 8mm film. Color movies, per scene, cost scarcely more than snapshots . . . black-and-white, even less. See superb Revere Eight equipment now at your dealer.

REVERE CAMERA COMPANY, CHICAGO 16, ILLINOIS

Revere

—EIGHT

In pursuit of happiness Revere adds to your pleasure

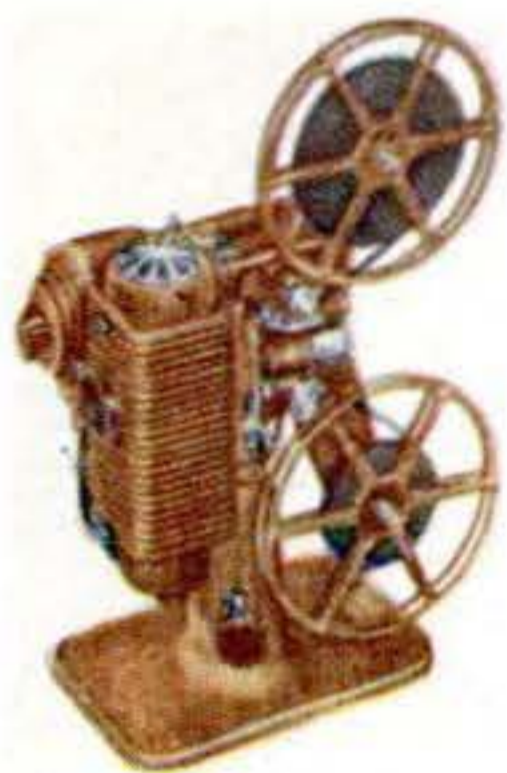

Revere "85" Projector
Theatre-like performance. Complete. \$120, inc. tax.



Revere "70" Magazine Camera F 2.8 Bausch & Lomb coated lens, \$127.50, inc. tax.



Revere "99" Turret Camera
With F 2.8 Bausch & Lomb coated lens, \$110, inc. tax.



Revere "88" Camera
With F 2.5 Wollensak Anastigmat coated lens, \$77.50 inc. tax.



Revere "60" Magazine Turret Camera
With F 2.8 Bausch & Lomb coated lens, \$152.50, inc. tax.



Revere Curvomatic Splicer
An appreciated gift for the home movie fan, \$16.50, inc. tax.

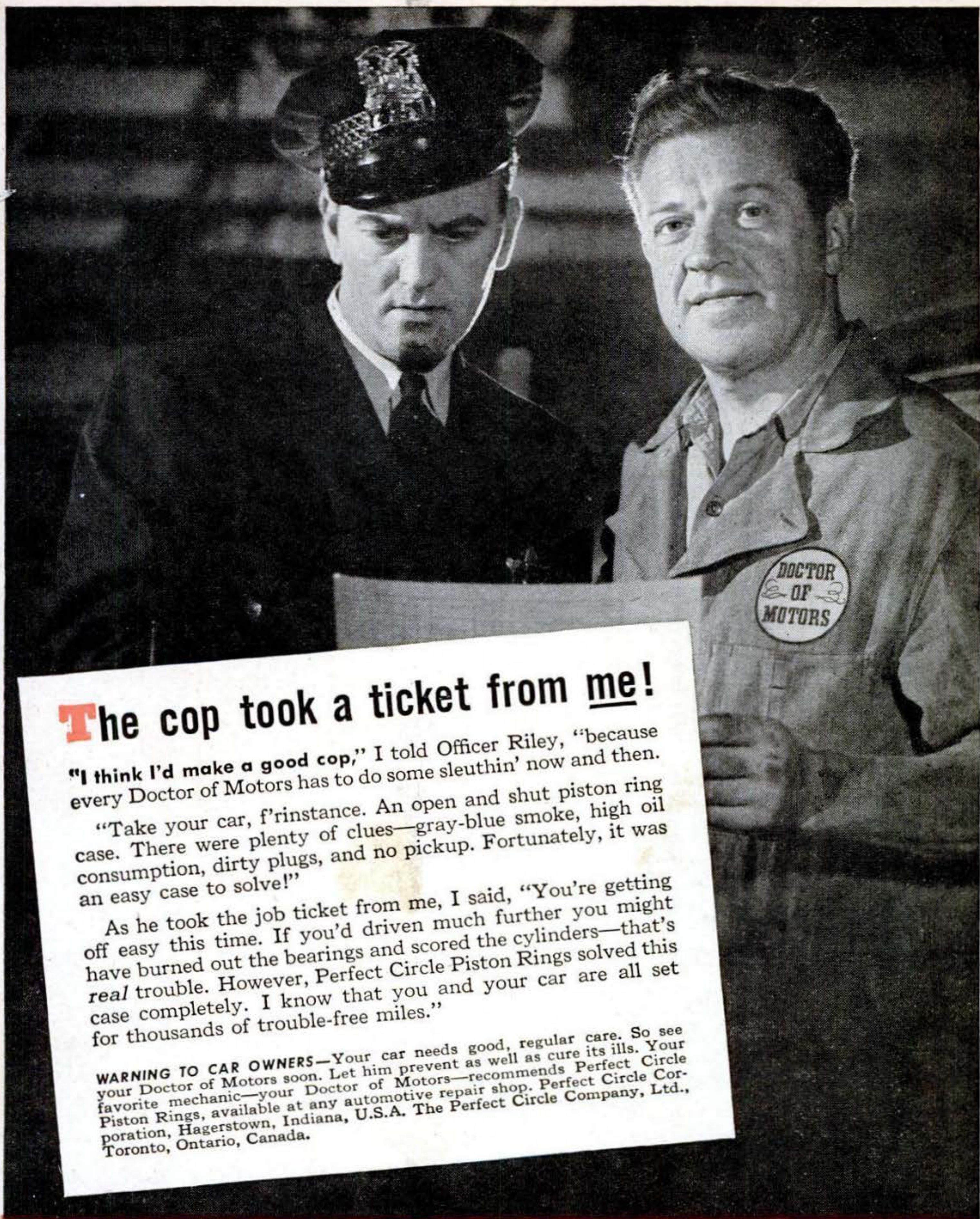

The cop took a ticket from me!

"I think I'd make a good cop," I told Officer Riley, "because every Doctor of Motors has to do some sleuthin' now and then.

"Take your car, f'rinstance. An open and shut piston ring case. There were plenty of clues—gray-blue smoke, high oil consumption, dirty plugs, and no pickup. Fortunately, it was an easy case to solve!"

As he took the job ticket from me, I said, "You're getting off easy this time. If you'd driven much further you might have burned out the bearings and scored the cylinders—that's real trouble. However, Perfect Circle Piston Rings solved this case completely. I know that you and your car are all set for thousands of trouble-free miles."

WARNING TO CAR OWNERS—Your car needs good, regular care. So see your Doctor of Motors soon. Let him prevent as well as cure its ills. Your favorite mechanic—your Doctor of Motors—recommends Perfect Circle Piston Rings, available at any automotive repair shop. Perfect Circle Corporation, Hagerstown, Indiana, U.S.A. The Perfect Circle Company, Ltd., Toronto, Ontario, Canada.

Your Doctor of Motors
restores power . . . saves gas
. . . saves oil with . . .

**PERFECT
CIRCLE** PISTON
RINGS



VOL. 151 : NO. 6

POPULAR SCIENCE

MECHANICS AND HANDICRAFT REG. U.S. PAT. OFF. *Monthly*

EDITOR: Perry Githens

MANAGING EDITORS: Fred O. Newman, Volta Torrey. **ART EDITOR:** Howard C. Jensen.

MECHANICS & HANDICRAFT EDITORS: Harry Walton, Frank Rowsome, Jr.

ASSOCIATE EDITORS: Alden P. Armagnac, Devon Francis, Robert Gorman, Sheldon Gallager, Hartley E. Howe, Herbert Johansen, Martin Mann, John F. Stearns, R. P. Stevenson.

ART DIRECTOR: Harry Samuels. **ART ASSOCIATES:** Herbert Anthony, Eric Karminski, Jr., Saverio Rada, Frances Cooper (Production).

STAFF PHOTOGRAPHERS: W. W. Morris (Chief), Hubert Luckett, Robert F. Smith.

WESTERN EDITOR: Andrew R. Boone (Los Angeles).

EDITORIAL ASSISTANTS: Mae G. Dyer (Assistant to the Editor), Julia Charnif, Carol Ennis, Agnes T. Quille, Lillian Thalenfeld, Ruth Westphal.

PUBLISHER: Godfrey Hammond

CONTENTS FOR DECEMBER, 1947

Cover painting by Ray Pioch

Science News

Piccard's Submarine Balloon.....	82
"Sanding Roads" for Planes.....	103
Underwater Television.....	104
Jet Propels Bicycle.....	112

Science at Work

Picture of the Month.....	81
Catching Criminals by a Hair.....	108
Necktie Designers Can Use Electrons....	115
Using Oil to Pump Oil.....	126
House Tests Heat Flow.....	146

PSM Features

Silent Kick Starts 1948 Motorcycle.....	88
Locomotive Laundry.....	90
How to Make Two Bits.....	106
Turning a Watch Inside Out.....	116
How Docks Lift Ships from the Sea.....	121
Toys Crawl, Wiggle and Pop.....	124
Dressing Up the RFD.....	128
How Your Automatic Toaster Works.....	134
Think You Know Nails?.....	138
They Still Cut Ice the Old Way.....	144
Clipping a Toy Together.....	147
Shop in Desert Keeps Diesels Rolling....	148
Chemistry Spins a Yarn.....	214

Aviation

Flying Wing Weds Jets.....	89
Biggest Plane Makes First Flight.....	92
What's New in Aviation.....	94
We Flew the Atlantic "No Hands".....	97
XB-46 (Pin-up).....	113
Reducing Diet for the B-36.....	118
Switchyard for Air Liners.....	120
Real Planes Add Up to a Dream.....	136

Automobiles

This Road Talks Back.....	89
Most Flats Are Your Own Fault.....	154
Auto Ideas.....	158
Gus Prescribes an Oil Change.....	160

Inventions

Buglike Boat Rides the Waves.....	105
I'd Like to See Them Make.....	114
New Ideas from the Inventors.....	130

Photography

Lens Tubes Shoot 'Em Big.....	198
Gas-Mask Holder Is Gadget Bag.....	200
Dive for Your Photos.....	201
Photo Ideas and Equipment.....	202

Continued on page 4

Published monthly at 353 Fourth Avenue, New York 10, N. Y., by Popular Science Publishing Co., Inc. Godfrey Hammond, President and Treasurer; R. C. Wilson, Raymond J. Brown, Stephen P. Glennon, Vice-Presidents; F. W. Briggs, Secretary. Entered as second-class matter Dec. 28, 1918, at the Post Office at New York under the act of March 3, 1879; additional entry as second-class matter at Dayton, Ohio. Entered as second-class matter at the Post Office Department, Canada. Printed in U. S. A. Copyright, 1947, by Popular Science Publishing Co., Inc. All rights reserved in the United States, Great Britain, and in all countries participating in the International Copyright Convention and Pan-American Copyright Convention. Yearly subscriptions to United States, its possessions and Canada, \$2.50; foreign countries, \$3.50. Subscribers must notify us of change of address four weeks in advance of the next publication date. Be sure to give both old and new addresses, including zone numbers.

CASTLE FILMS ARE GREAT GIFTS!

8 mm-16 mm

OWN OR GIVE FOOTBALL PARADE OF THE YEAR

The exciting moments and spectacular plays that rocked the stands at the season's greatest grid-iron battles. Thrill to this gripping sports drama, a living record of the best in collegiate football.

ALL THESE GAMES IN ONE FILM

ARMY vs. NAVY
YALE vs. HARVARD
NOTRE DAME vs. TULANE
PURDUE vs. OHIO
NORTHWESTERN vs. ILLINOIS
CALIFORNIA vs. WASHINGTON
DUKE vs. GEORGIA TECH
PENNSYLVANIA vs. COLUMBIA

(subject to change)

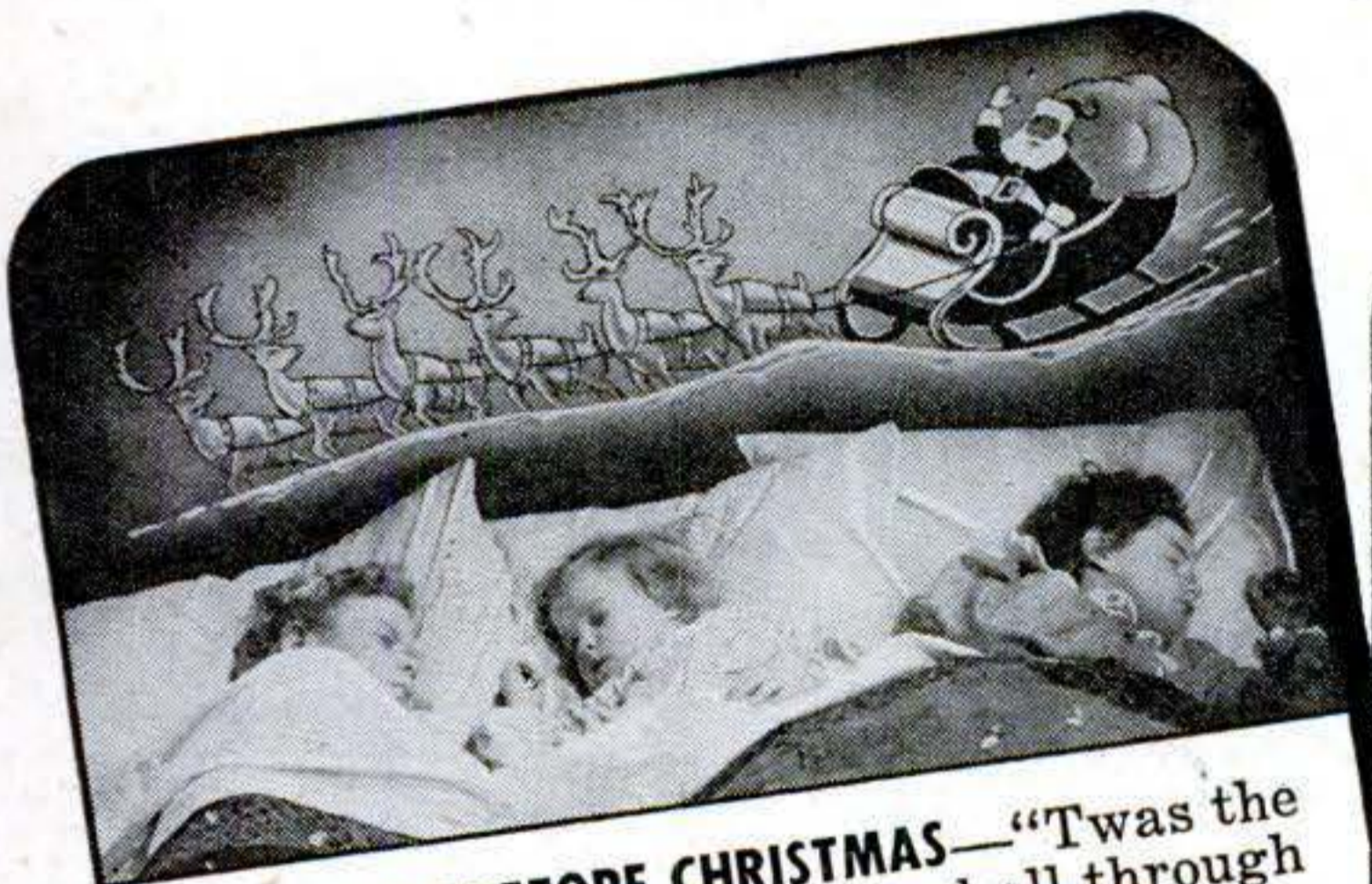

THE NIGHT BEFORE CHRISTMAS—"Twas the night before Christmas, and all through the house". Who doesn't know this famous popular poem. Now it comes to life in a splendidly produced home movie.

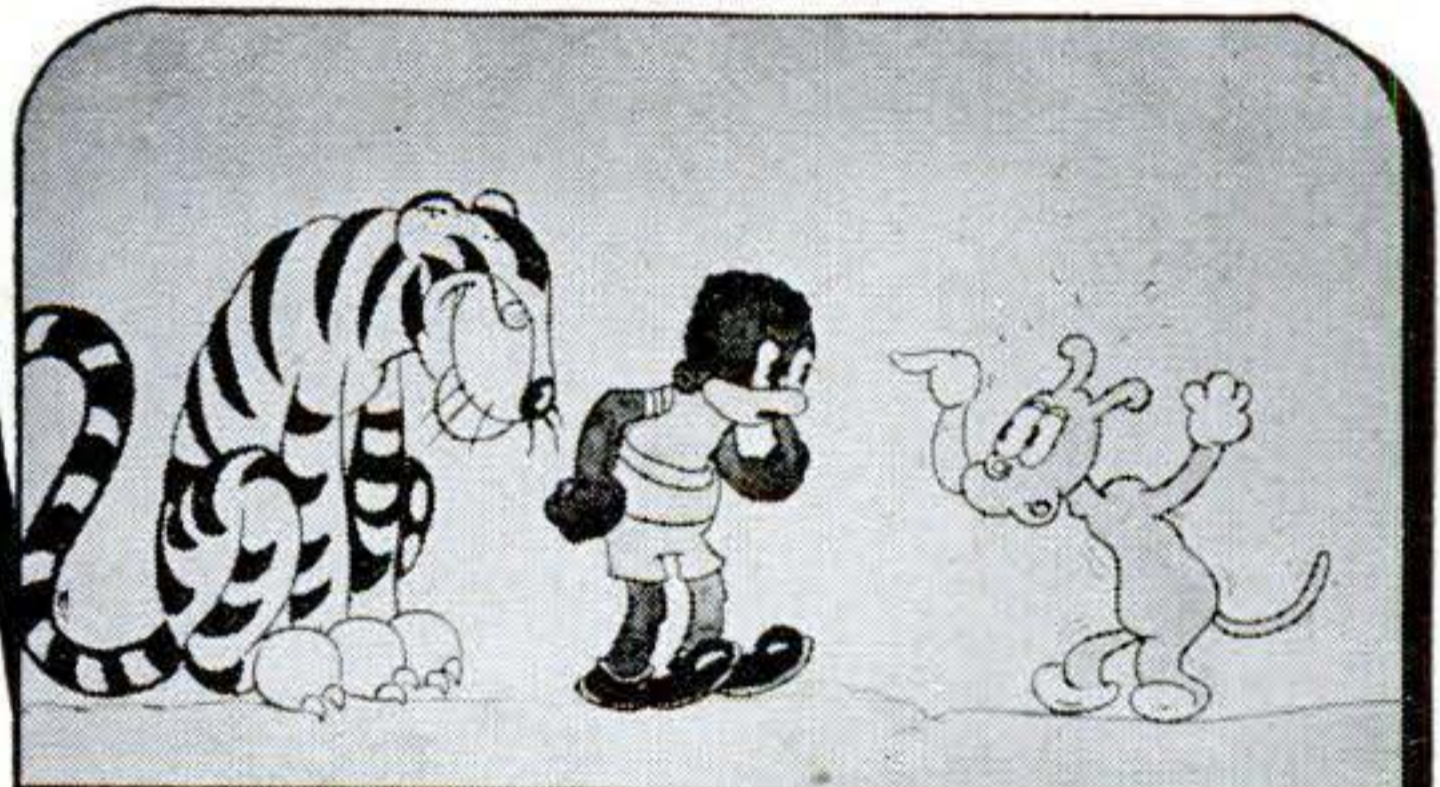

LITTLE BLACK SAMBO—Famous Fairytale of Sambo who plays with a dog painted with stripes like a tiger. When a real tiger appears, Sambo thinks it's his dog. Laugh riot of suspense! Surprise ending!

FREE!

to all projector owners. Send for new 1947 Castle Films Catalogue describing more than 170 thrilling home movies.

CASTLE FILMS

DIVISION OF UNITED WORLD FILMS INC.

445 PARK AVENUE
NEW YORK 22

FIELD BLDG.
CHICAGO 3

RUSS BLDG.
SAN FRANCISCO 4

SEE YOUR PHOTO DEALER IMMEDIATELY
OR SEND HANDY ORDER FORM **TODAY!**

ORDER FORM

Send Castle Films indicated in the size and length checked.	8 mm.		16 mm.		
	50 Feet	Complete	100 Feet	Complete	Sound
"Football Parade"	\$175	\$550	\$275	\$875	\$1750
"Night Before Christmas"					
"Little Black Sambo"					

Name _____

Address _____

City _____ Zone _____ State _____

Remittance Enclosed Ship COD Send me Castle Films' FREE De Luxe Catalog

0-12

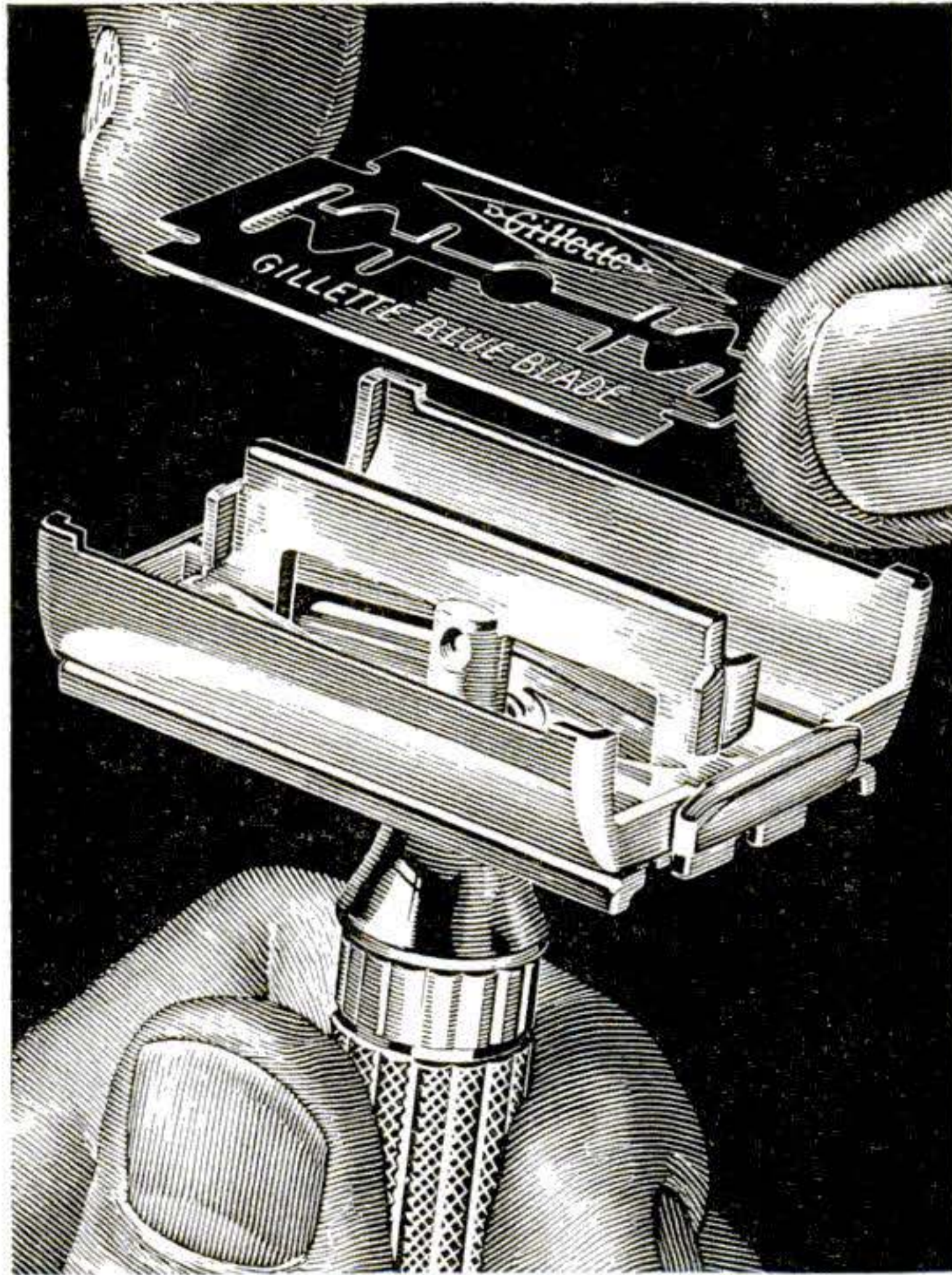

You change blades in a flash with the modern
Gillette
ONE-PIECE RAZOR

SHAVING is mighty quick and easy when you use a modern Gillette One-Piece Razor. There's nothing to take apart or put together. You change blades in jig time. Twist . . . the razor opens. Twist again . . . your blade's locked in position. For cleaning both razor and blade just loosen the holder, rinse and shake.

Enjoy utmost shaving comfort and convenience. Get a Gillette One-Piece Razor. The Gillette Aristocrat, gold-plated, with case and 10 Gillette Blue Blades, \$3.79. The Gillette Milord, gold-plated, with case and five blades, \$2.50. Either will give you years of shaving satisfaction.

**Gillette Safety Razor Co.,
 Boston 6, Mass.**

Copyright, 1947, by Gillette Safety Razor Company

look *SHARP!* feel *SHARP!* be *SHARP!*
 use
Gillette Blue Blades
 WITH THE SHARPEST EDGES EVER HONED



Mechanics & Shopcraft

Spool Used as Level.....	176
Lathe Chuck Doubles as Vise.....	189
New Shop Ideas.....	190
Spring Calipers Aid Measuring.....	192
Clips Hold Rolled Blueprints.....	197
How to Silverplate Wood.....	210
Copperplating Baby's Shoes.....	213
Drill-Press Rack Holds Tools.....	218
T-Square Marks Guide Borders.....	219
Two Aids Speed Pump Servicing.....	222
Tube Keeps Work on Sawhorse.....	223

Home Mechanics & Handicraft

Craftwork Projects of the Month.....	129
Laminated Plastic Works Color Magic....	132
Basket Chair and Taboret.....	164
Swinging Doors Close Off Kitchen.....	165
Electric Clock Plays Music.....	166
Child's Wardrobe Is Hammer-Saw Job....	170
Kiddy Car in Tractor Style.....	173
Infrared Lamp Dries Drafting Ink.....	176
Last-Minute Gift Projects.....	178
Doll House Stores Flat.....	181
Bank "Explodes" When Full.....	182
Repeater Rubber-Band Gun.....	183
Toy Workmen Drive Spike.....	184
Wrought-Iron Tables Have Glass Tops....	186
Copper-and-Plastic Book Ends.....	188
Fuel Oil Pumped Upstairs.....	197
Stove Burns Crankcase Drainings.....	218
Baby Enjoys Carriage Window.....	219
Fusible Links Shut Off Burner.....	223

Radio & Electricity

Thunderbolt Tower.....	102
Operating in Safety.....	112
Antenna Gives Radios Global Range.....	150
Completing Your Multimeter (III).....	204
Formulas for Multimeters.....	206
Midget Volt-Ohmmeter.....	207
News in Electronics.....	209

Departments

Letters	16
Voice of Science.....	79A
Aids to Modern Living.....	152
Keeping the Home Shipshape.....	174
Hobby Shopping.....	177
What's Your I. Q.?.....	185
New Tools.....	195
They Built PSM Projects.....	196
Home Experiments	220
For Easier Farming.....	224
Editorial Memo.....	282



Free as a balloon!

RID YOURSELF of economic worries and that's how you feel.

I.C.S. can show you how. Greater job security, more responsible work, higher pay, a home of your own—whatever you want is attainable if you qualify as one of the *trained* men vital to business and industry.

In today's world, untrained talent doesn't have a chance against expert knowledge. That's the reason why so

many ambitious Americans are studying I. C. S. courses in 400 technical and commercial subjects — readying themselves for the big rewards.

I. C. S. receives more than 1500 letters a year from students reporting salary increases and promotions. Mark and mail the coupon as they did — and you, too, can be on the road to economic freedom. It's a grand and glorious feeling to join the successful!

INTERNATIONAL CORRESPONDENCE SCHOOLS



BOX 7697-L, SCRANTON 9, PENNA.

Without cost or obligation, please send me full particulars about the course BEFORE which I have marked X:

- | | | | |
|--|--|--|---|
| <p>Business and Academic Courses</p> <ul style="list-style-type: none"> <input type="checkbox"/> Accounting <input type="checkbox"/> Arithmetic <input type="checkbox"/> Business Administration <input type="checkbox"/> Business Correspondence <input type="checkbox"/> Certified Public Accounting <input type="checkbox"/> Commercial <input type="checkbox"/> Commercial Art <input type="checkbox"/> Cost Accounting <input type="checkbox"/> Federal Tax <input type="checkbox"/> First Year College <input type="checkbox"/> Foremanship <input type="checkbox"/> Good English <input type="checkbox"/> Higher Mathematics <input type="checkbox"/> Motor Traffic <input type="checkbox"/> Salesmanship <input type="checkbox"/> Sign Lettering <input type="checkbox"/> Spanish <input type="checkbox"/> Traffic Management <p>Air Conditioning and Plumbing Courses</p> <ul style="list-style-type: none"> <input type="checkbox"/> Air Conditioning <input type="checkbox"/> Heating <input type="checkbox"/> Refrigeration | <p>Chemistry Courses</p> <ul style="list-style-type: none"> <input type="checkbox"/> Chemical Engineering <input type="checkbox"/> Chemistry, Analytical <input type="checkbox"/> Chemistry, Industrial <input type="checkbox"/> Chemistry, Mfg. Iron & Steel <input type="checkbox"/> Petroleum Refining <input type="checkbox"/> Pulp and Paper Making <p>Civil Engineering, Architectural and Mining Courses</p> <ul style="list-style-type: none"> <input type="checkbox"/> Architecture <input type="checkbox"/> Architectural Drafting <input type="checkbox"/> Building Estimating <input type="checkbox"/> Civil Engineering <input type="checkbox"/> Contracting and Building <input type="checkbox"/> Highway Engineering <input type="checkbox"/> Lumber Dealer <input type="checkbox"/> Reading Structural Blueprints <input type="checkbox"/> Sanitary Engineering <input type="checkbox"/> Structural Drafting <input type="checkbox"/> Structural Engineering <input type="checkbox"/> Surveying and Mapping <p>Communications Courses</p> <ul style="list-style-type: none"> <input type="checkbox"/> Electronics <input type="checkbox"/> Practical Telephony <input type="checkbox"/> Radio, General <input type="checkbox"/> Radio Operating | <ul style="list-style-type: none"> <input type="checkbox"/> Radio Servicing <input type="checkbox"/> Telegraph Engineering <p>Electrical Courses</p> <ul style="list-style-type: none"> <input type="checkbox"/> Electrical Drafting <input type="checkbox"/> Electrical Engineering <input type="checkbox"/> Electric Light and Power <input type="checkbox"/> Lighting Technician <input type="checkbox"/> Practical Electrician <input type="checkbox"/> Power House Electric <input type="checkbox"/> Ship Electrician <p>Internal Combustion Engines Courses</p> <ul style="list-style-type: none"> <input type="checkbox"/> Auto Technician <input type="checkbox"/> Diesel-Electric <input type="checkbox"/> Diesel Engines <p>Mechanical Courses</p> <ul style="list-style-type: none"> <input type="checkbox"/> Aeronautical Engineer's, Jr. <input type="checkbox"/> Aircraft Drafting <input type="checkbox"/> Flight Engineer <input type="checkbox"/> Forging <input type="checkbox"/> Heat Treatment of Metals <input type="checkbox"/> Industrial Engineering <input type="checkbox"/> Industrial Metallurgy <input type="checkbox"/> Machine Shop <input type="checkbox"/> Machine Shop Inspection | <ul style="list-style-type: none"> <input type="checkbox"/> Mechanical Drafting <input type="checkbox"/> Mechanical Engineering <input type="checkbox"/> Mold-Loft Work <input type="checkbox"/> Patternmaking—Wood, Metal <input type="checkbox"/> Reading Shop Blueprints <input type="checkbox"/> Sheet-Metal Drafting <input type="checkbox"/> Sheet-Metal Worker <input type="checkbox"/> Ship Drafting <input type="checkbox"/> Tool Designing <input type="checkbox"/> Welding—Gas and Electric <p>Railroad Courses</p> <ul style="list-style-type: none"> <input type="checkbox"/> Air Brake <input type="checkbox"/> Diesel Locomotive <input type="checkbox"/> Locomotive Engineer <input type="checkbox"/> Locomotive Fireman <input type="checkbox"/> Railroad Section Foreman <p>Steam Engineering Courses</p> <ul style="list-style-type: none"> <input type="checkbox"/> Boilermaking <input type="checkbox"/> Combustion Engineering <input type="checkbox"/> Engine Running <input type="checkbox"/> Marine Engineering <input type="checkbox"/> Steam Electric <p>Textile Courses</p> <ul style="list-style-type: none"> <input type="checkbox"/> Cotton Manufacturing <input type="checkbox"/> Rayon Weaving <input type="checkbox"/> Woolen Manufacturing |
|--|--|--|---|

Name _____ Home Address _____

City _____ State _____

Age _____ Present Position _____ Working Hours _____ A.M. to _____ P.M.

Special tuition rates to members of the Armed Forces. Special discount to World War II Veterans.
Canadian residents send coupon to International Correspondence Schools Canadian, Ltd., Montreal, Canada.

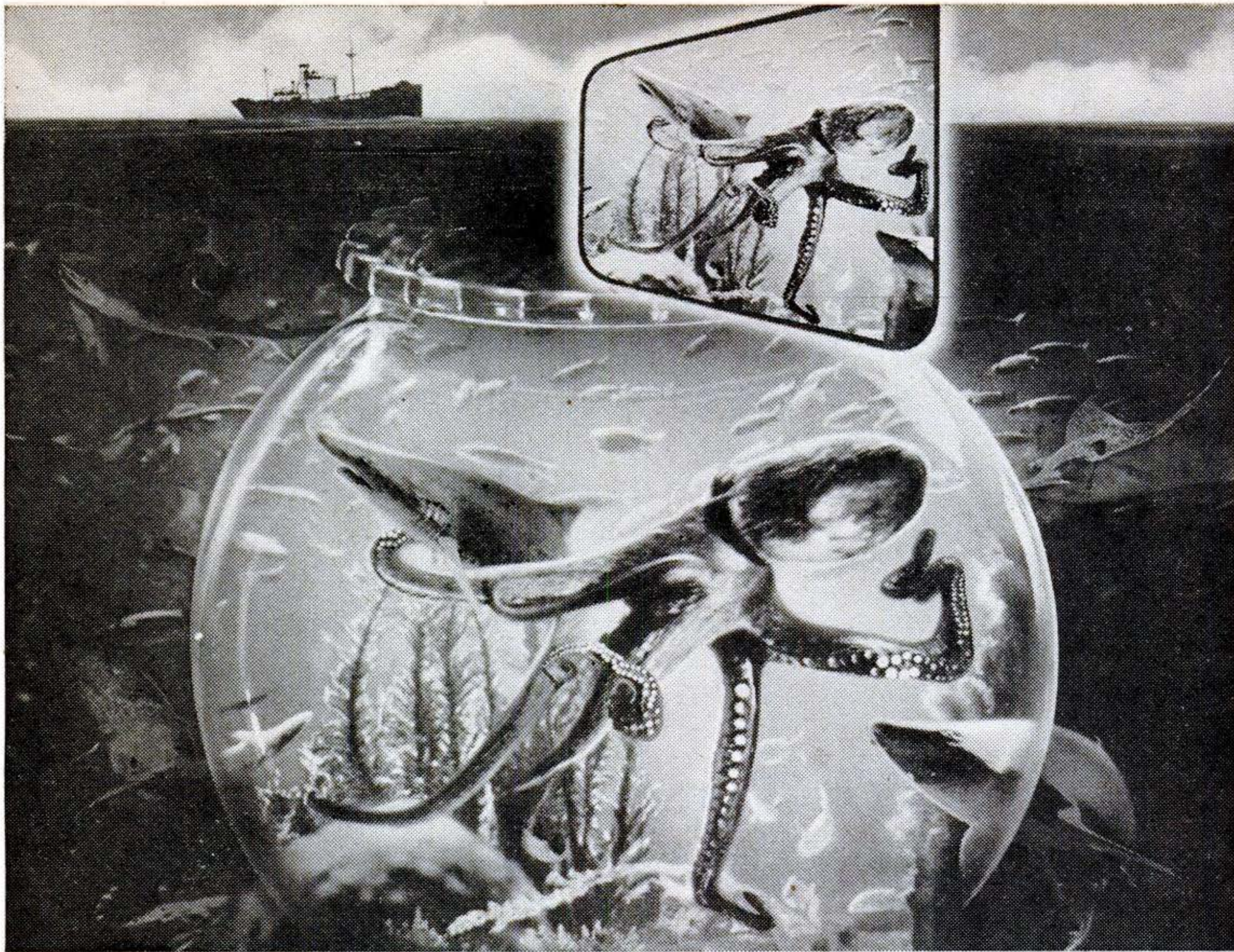

Exploration of ocean depths is made possible by RCA Image Orthicon television camera.

The ocean is a "goldfish bowl" to RCA Television!

Another "first" for RCA Laboratories, undersea television cameras equipped with the RCA Image Orthicon tube were used to study effects of the atom blast at Bikini...

There may come a day when fishermen will be able to drop a television eye over the side to locate schools of fish and oyster beds... Explorers will scan marine life and look at the ocean floor... Undersea wrecks will be observed from the decks of ships without endangering divers.

With the television camera, long-hidden mysteries of the ocean depths

may be as easy to observe as a goldfish bowl—in armchair comfort and safety.

Exciting as something out of Jules Verne, this new application of television is typical of research carried out at RCA Laboratories. Advanced scientific thinking is part of any product bearing the name RCA, or RCA Victor.

When in Radio City, New York, be sure to see the radio and electronic wonders at RCA Exhibition Hall, 36 West 49th St. Free admission. *Radio Corporation of America, RCA Building, Radio City, New York 20.*



Through RCA Victor home television you see the best in entertainment... educational subjects... the news... and "history as it happens." Ask your dealer to demonstrate RCA Victor home television sets.



RADIO CORPORATION of AMERICA

Whenever you have your headlamps replaced, be sure to insist on

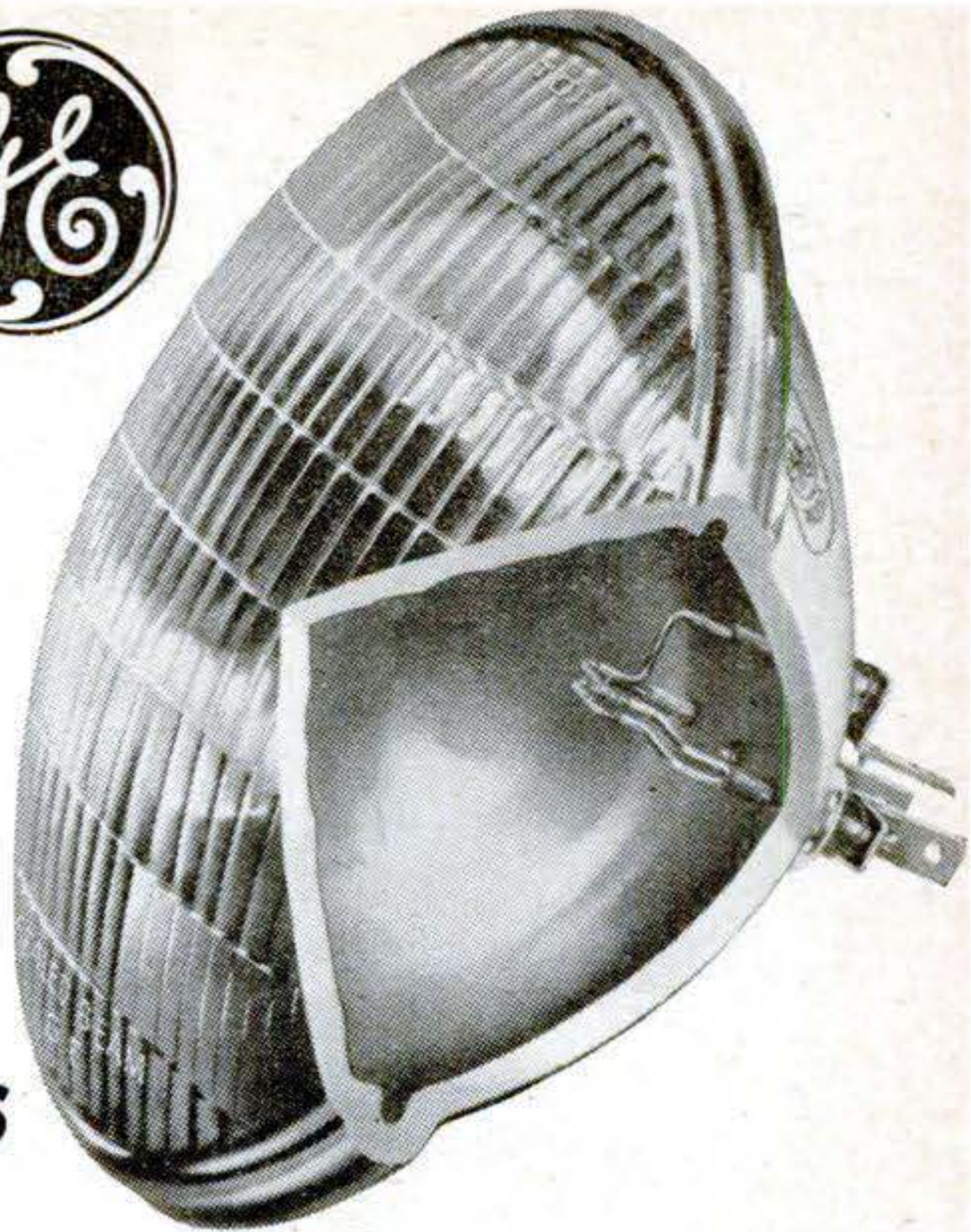
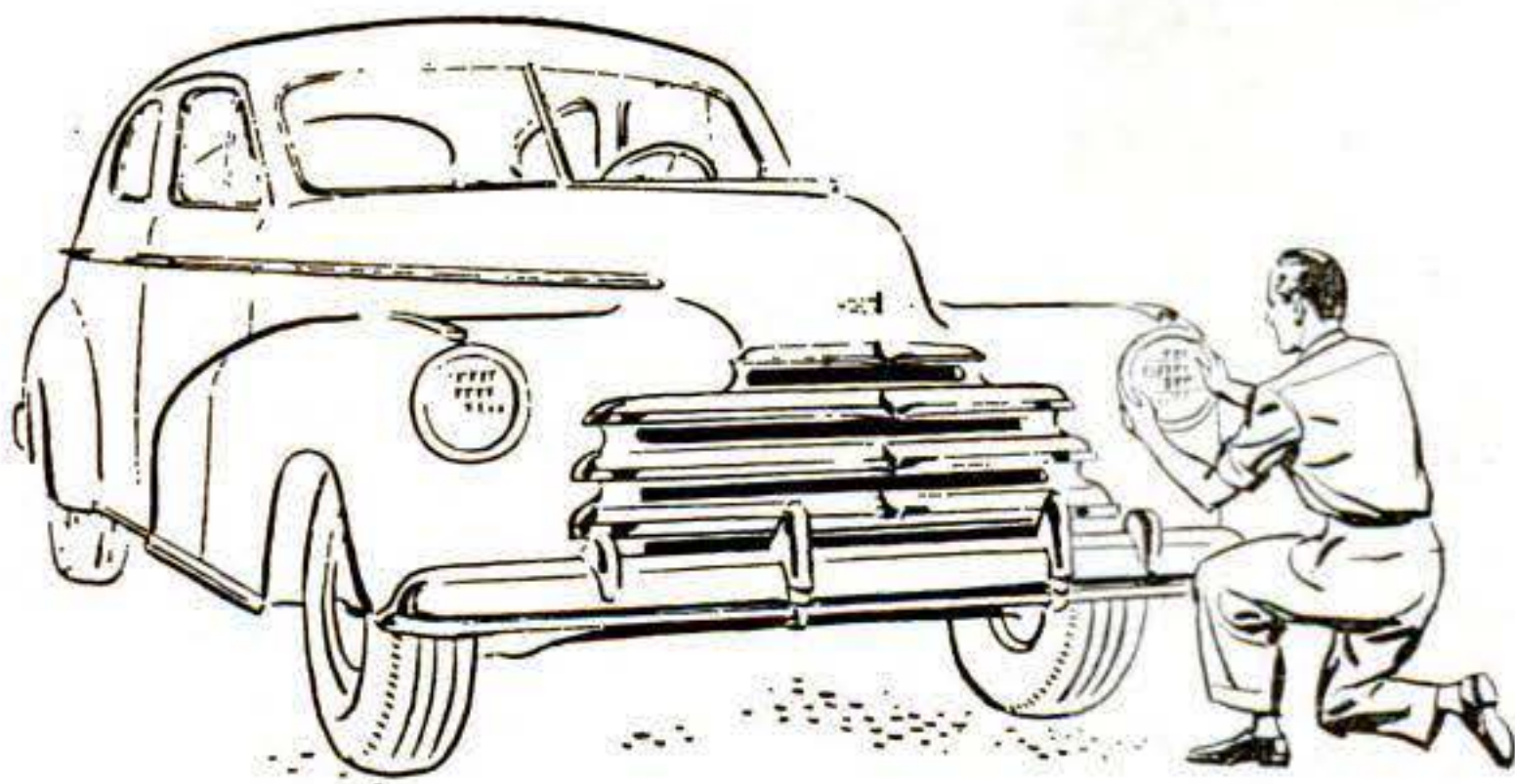

Because G-E sealed beam lamps

DO NOT GROW DIM!

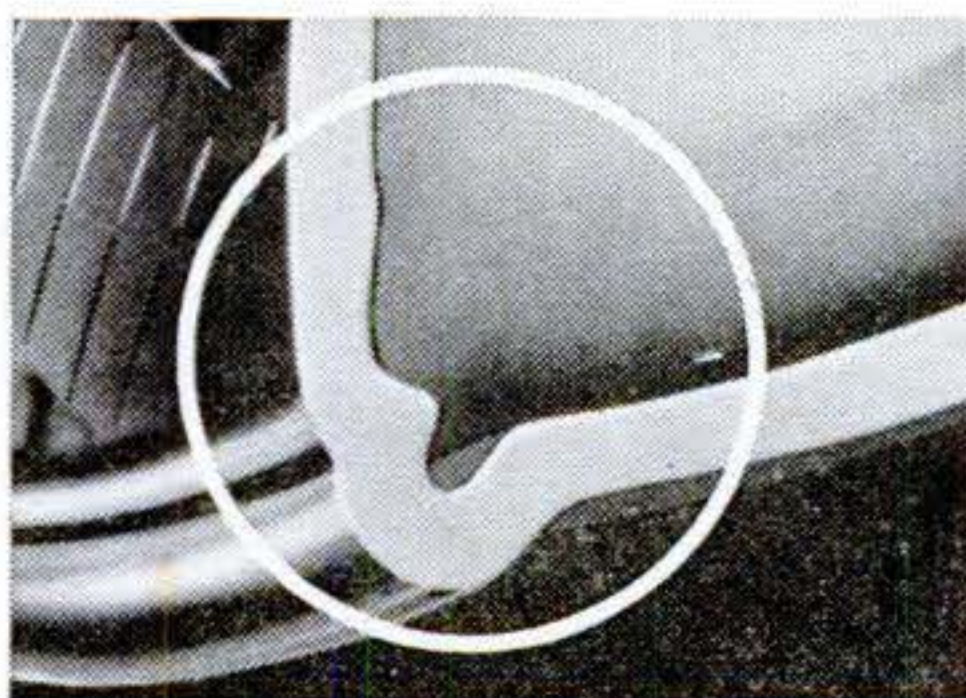

1 **ENTIRE HEADLAMP** is a one piece "all-glass" unit. Thus, dirt and moisture can't get in to reduce light output.

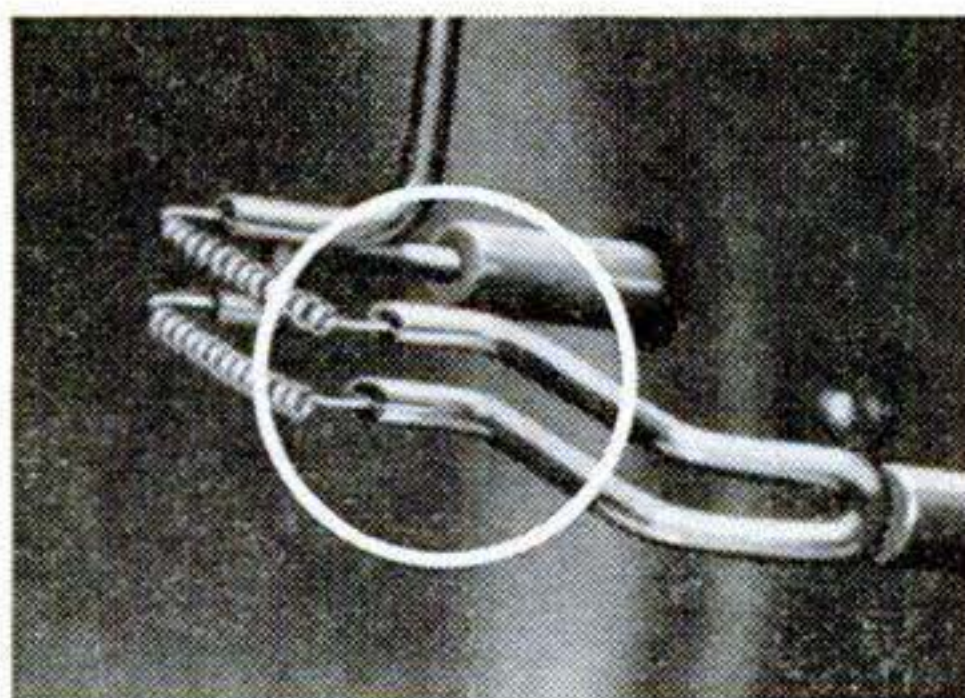

2 **THE LIGHT-SOURCE** filaments are held in special vise-like grip. Road shock and vibration will not shake them loose and cause light failure.

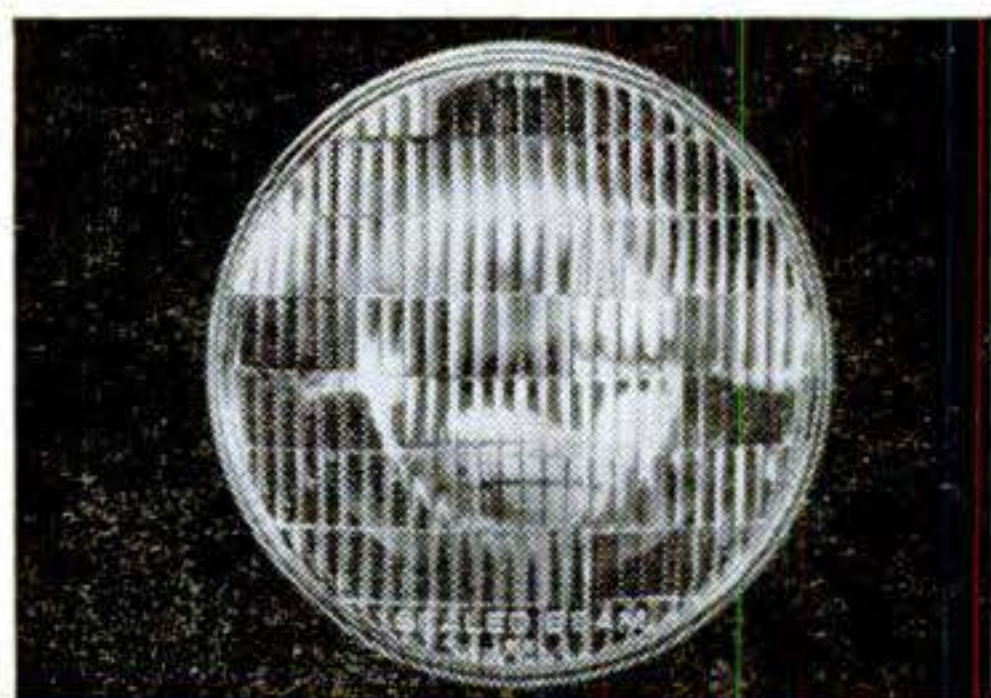

3 **PRECISION LENS** of rugged hard-glass construction is designed to put an accurate pattern of light where you need it—*on the road.*

ROAD and laboratory tests prove that the average General Electric Sealed Beam Headlamp maintains 99% of original light output right up to the end of lamp life. They do not grow dim! You get "new car" lighting always.

12% more light on the road. Now G-E Sealed Beam headlamps give you easier night driving than ever before...12% more light on the road for driving and 16% more light for passing. Just another reason why General Electric Sealed Beam lamps are your best buy!

For every socket,
for every car...

G-E LAMPS
GENERAL  ELECTRIC

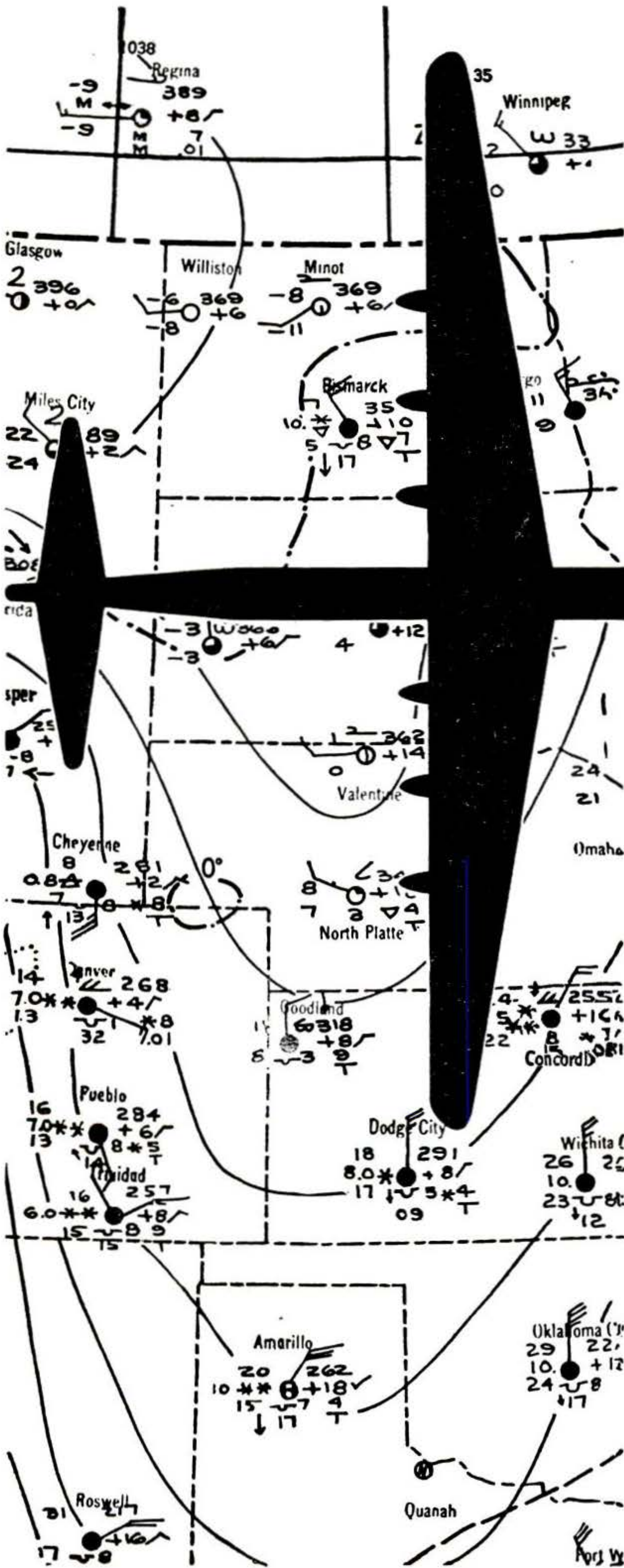

Gone with the wind currents!

THE U. S. Air Force is making time these days against its gusty old antagonist, the head-wind. With the newly developed Minimal Flight Path, Air Force pilots now harness the wind currents going their way — speed up their time of arrival by as much as 20% in flights over 500 miles long.

Use of the new system, which can be computed in 30 minutes or less by experienced weather men, frequently means leaving the Great Circle route — long recognized as the shortest distance between points on the earth's surface — but such deviations bring favorable tail-wind currents into the flight path and compensate for the added distance.

In terms of navigational progress, the Minimal Flight Path means substantial reductions in fuel loads with a corresponding increase in pay-loads. Later on, as seasonal and other fluctuations are determined, air routes the world over may be in for some drastic, time-saving revisions.

Such progress, typical of Air Force leadership in aviation, is made by men who believe in the future of this great new science. If you're interested in joining a pioneering organization, ask at your nearest U. S. Army and Air Force Recruiting Station for details on Air Force career opportunities today!

**U. S. ARMY AND U. S. AIR FORCE
RECRUITING SERVICE**

**CAREERS WITH A FUTURE
U. S. Army and
U. S. Air Force**

**THE CADETS ARE FLYING AGAIN.
ASK FOR FULL DETAILS NOW.**

Become an EXPERT ACCOUNTANT through LASALLE'S PROBLEM METHOD

WHAT is the LaSalle Problem Method of acquiring Higher Accountancy Training?

Certainly not the dull routine associated with ordinary study—not “book-learning” in the theoretical sense.

Under the Problem Method each week you are given an important accounting principle—then shown how the principle is applied. You are given a problem and its solution. After you fully understand the principle and its application, you are then given a problem which you work out for yourself and send in to LaSalle. Your solution is returned to you with comments. If it has not been properly solved you are shown your error and the correct method.

The entire procedure is practically first-hand personal experience gained by you direct from capable accountancy instructors. These men take an interest in you, check your individual needs and work with you step by step as you progress.

You study and learn under a tested, proven plan built around the Problem Method. You continuously learn by actually handling important accountancy problems, analyzing, working them out and thinking out your own decisions.

Thus you are coached in the practical solving of the very problems you face in a higher accountancy position. Step by step you work mat-



More Money—A Better Position

ters out for yourself. At the end of your training, you have real ability and practical experience—the kind which fits you for positions that business is glad to reward with real money.

Don't confuse Accountancy with bookkeeping. The Accountant is the executive, the man who makes the big money—the bookkeeper does only the detail routine jobs at low pay.

You can become an expert accountant through the LaSalle Problem Method without any preliminary knowledge of bookkeeping. You will be given whatever basic training, instruction or review on the subject of bookkeeping you need. Mail the coupon now for full information.

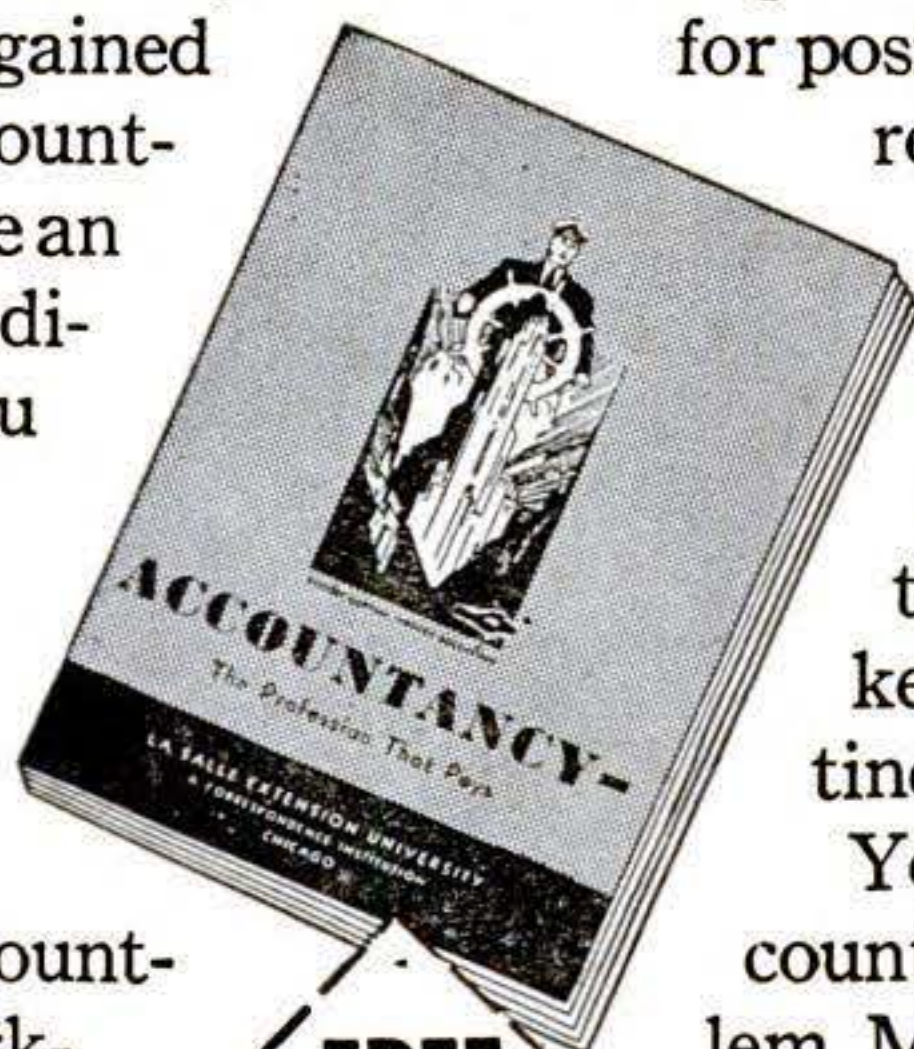

FREE ACCOUNTING BOOKLET

Send me, without obligation, your 48-page booklet “Accountancy, the Profession that Pays.”

GET STARTED NOW

Send for the Facts TODAY!

NAME.....
 POSITION.....AGE.....
 ADDRESS.....
 CITY.....ZONE.....STATE.....

LASALLE EXTENSION UNIVERSITY Dept. 1283-H
 A Correspondence Institution Chicago 5, Ill.

I Will
Show You
How to

Learn RADIO

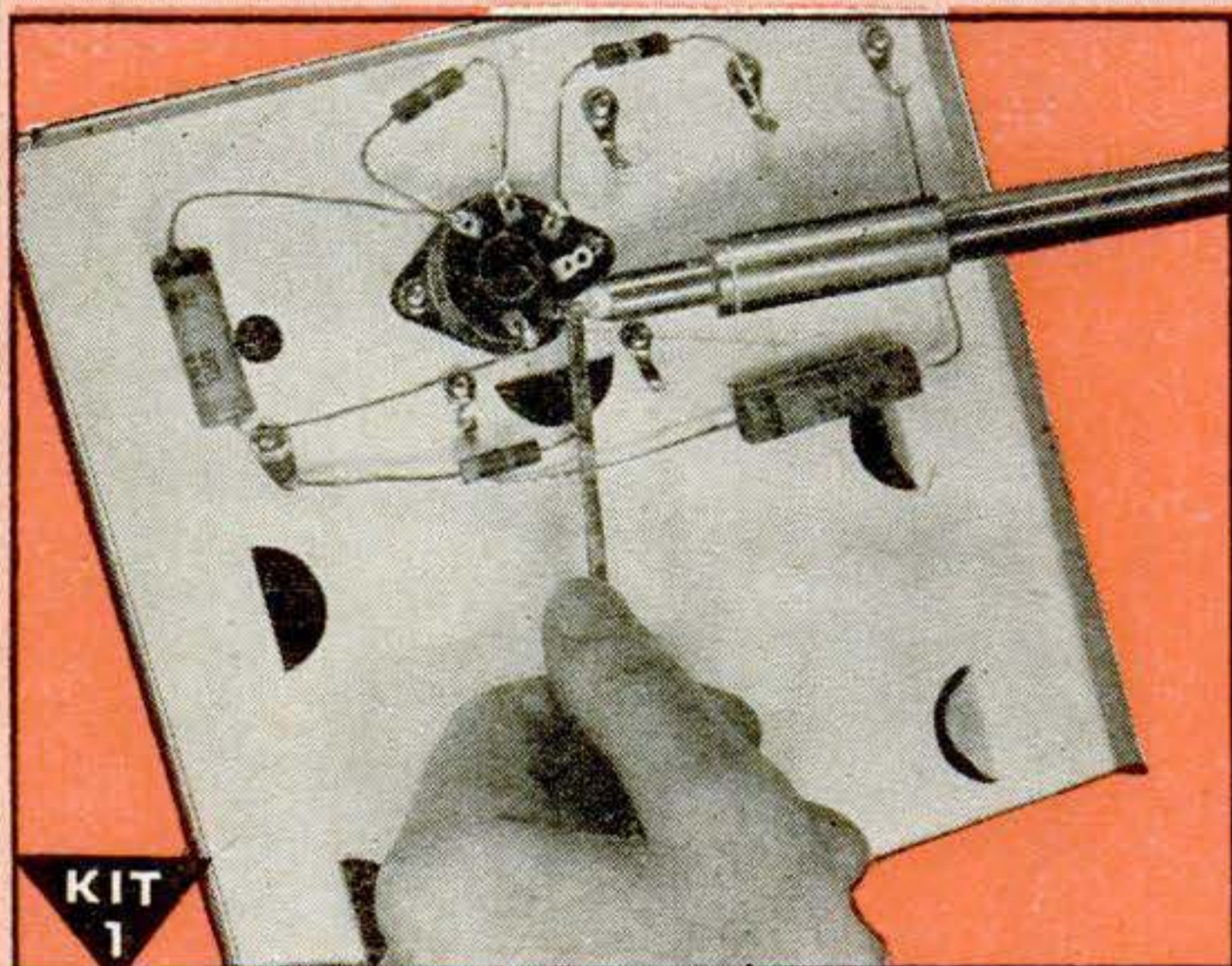

I send you Soldering Equipment and Radio parts; show you how to do Radio soldering; how to mount and connect Radio parts; give you practical experience.

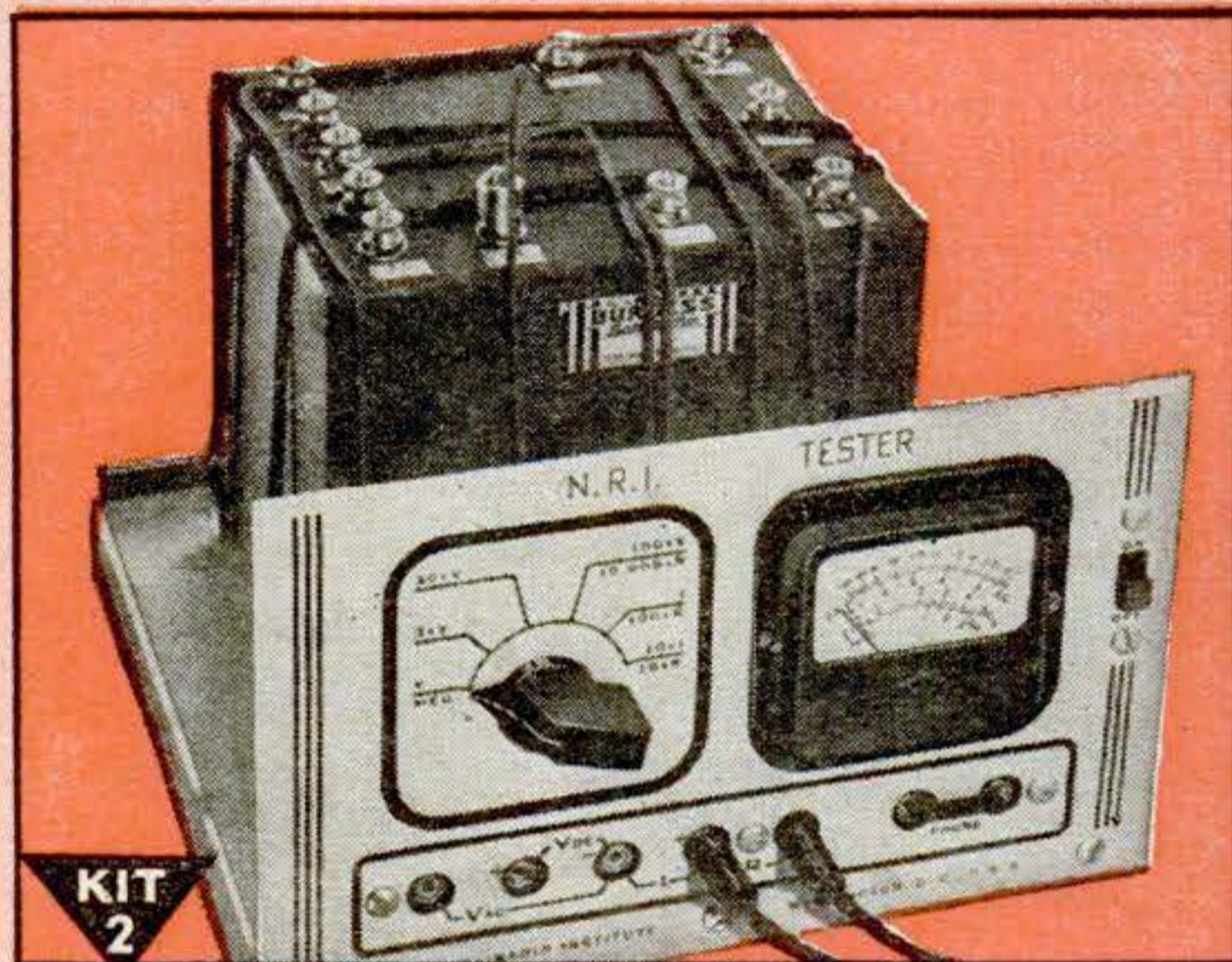

Early in my course I show you how to build this N.R.I. Tester with parts I send. It soon helps you fix neighborhood Radios and earn EXTRA money in spare time.

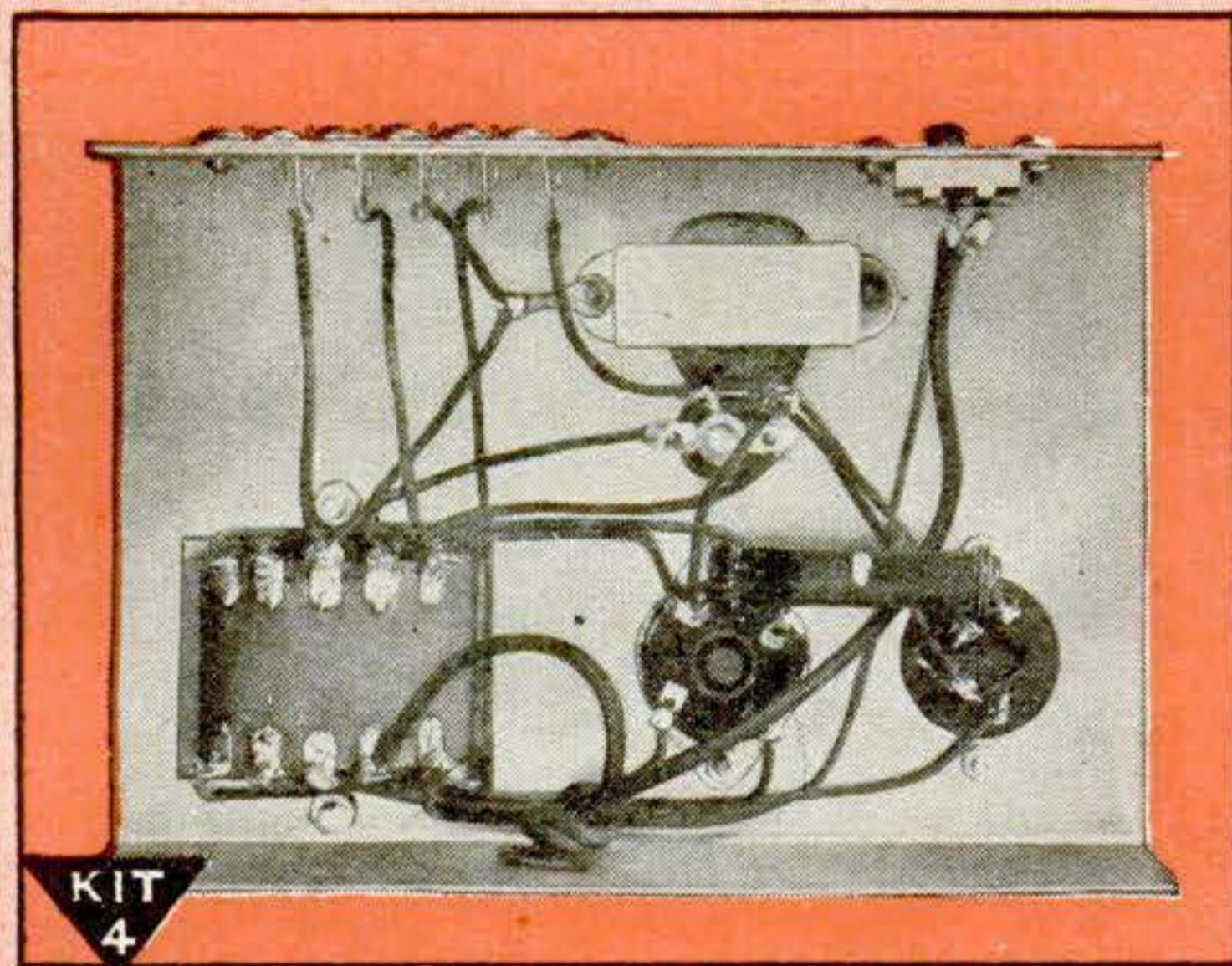

You get parts to build this Vacuum Tube Power Pack; make changes which give you experience with packs of many kinds; learn to correct power pack troubles.

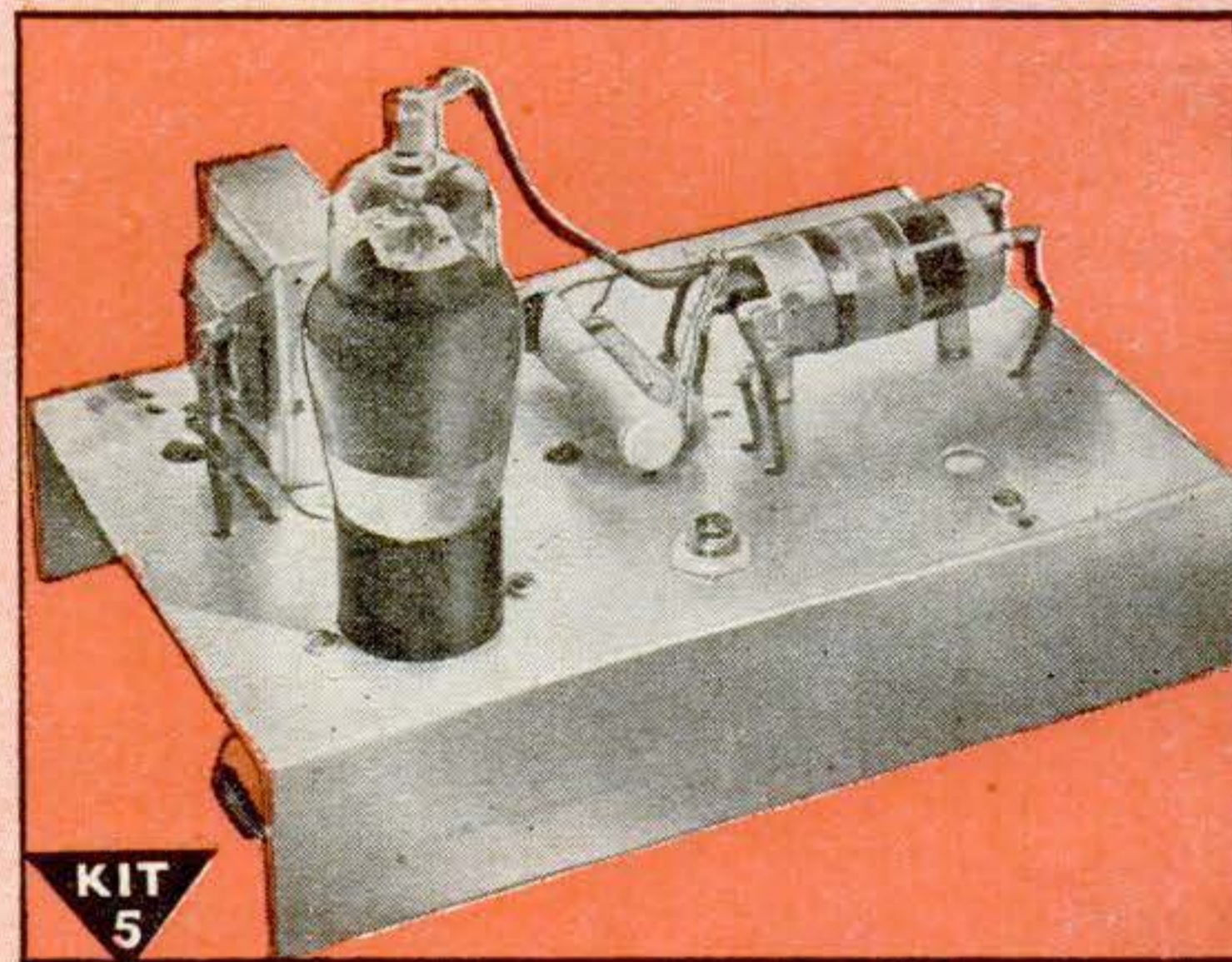

Building this A. M. Signal Generator gives you more valuable experience. It provides amplitude-modulated signals for many tests and experiments.

MEN I TRAIN AT HOME GET GOOD JOBS LIKE THESE

Made \$612, in 12 Months, Spare Time



"Soon after I finished my experimental kits lessons I tackled my first Radio service job. The neighbors were very cooperative. I soon had all the repair jobs I could handle in spare time. I have made \$612 in the past 12 months in spare time."—J. W. CLARK, Wilmington, N. C.

Minister Makes \$10-\$20 Weekly Spare Time



"I am a minister. I am in a county seat now trying to serve the people in my church, also trying to keep their Radios playing. I have been making from \$10 to \$20 per week in spare time."—L. H. SMITH, Benton, Tenn.

Knew Nothing About Radio



"I knew nothing about Radio when I enrolled. At present I am doing spare time work. I have more than paid for my Course and I have about \$200 worth of equipment which has paid for itself."—RAYMOND HOLT CAMP, Vandalia, Ill.

Doing Good Spare Time Business



"I have been getting receivers to repair right along lately, and by using the methods taught me in the NRI Course, I don't have to spend much time on any of them."—STANLEY N. STRICKLAND, 191 Dale Homes, Portsmouth, Va.

by Practicing in Spare Time

**I Send You
Big Kits
of Radio Parts**

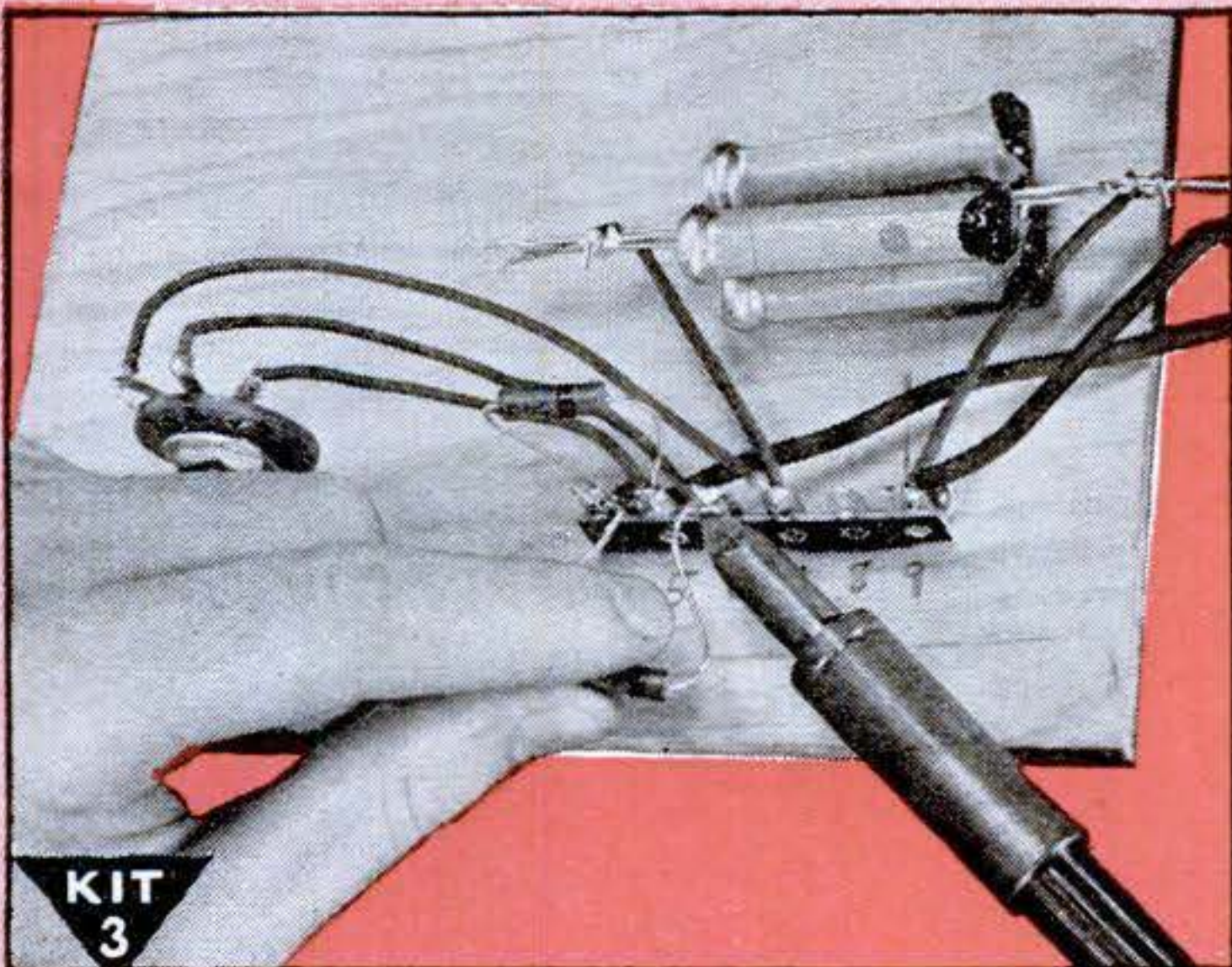

**KIT
3**

You get parts to build Radio Circuits; then test them; see how they work; learn how to design special circuits; how to locate and repair circuit defects.

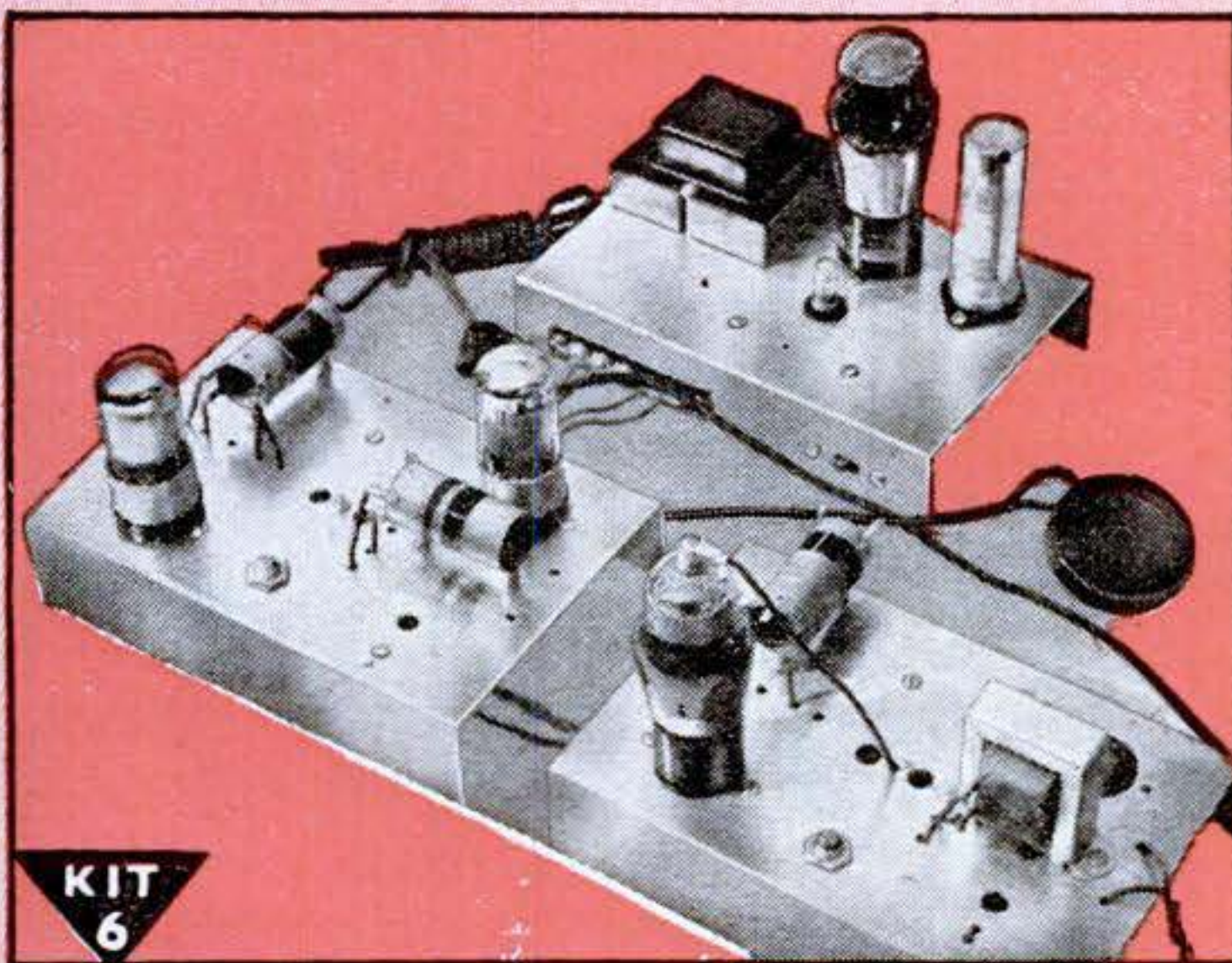

**KIT
6**

You build this Superheterodyne Receiver which brings in local and distant stations—and gives you more experience to help you win success in Radio.

**SAMPLE LESSON
FREE**

Gives hints on Receiver Servicing, Locating Defects, Repair of Loudspeaker, I.F. Transformer, Gang Tuner, Condenser, etc. Mail Coupon

GETTING ACQUAINTED WITH
RECEIVER SERVICING

**My Radio Course Includes
TELEVISION • ELECTRONICS
FREQUENCY MODULATION**

KNOW RADIO *Win Success* I Will Train You at Home

DO YOU want a good-pay job in the fast-growing Radio Industry—or your own Radio Shop? Mail the Coupon for a Sample Lesson and my 64-page book, "How to Be a Success in RADIO — Television, Electronics," both FREE. See how I will train you at home—how you get practical Radio experience building, testing Radio circuits with BIG KITS OF PARTS I send!

VETERANS

You can get this training in your own home under G.I. Bill. Mail coupon for full details.

Many Beginners Soon Make Extra Money in Spare Time While Learning

The day you enroll I start sending EXTRA MONEY manuals that show how to make EXTRA money fixing neighbors' Radios in spare time, while still learning! It's probably easier to get started now than ever before, because the Radio Repair Business is booming. Trained Radio Technicians also find profitable opportunities in Police, Aviation, Marine Radio, Broadcasting, Radio Manufacturing, Public Address work. Think of even greater opportunities as Television, FM, and Electronic devices become available to the public! Send for FREE books now!

Find Out What NRI Can Do For You

Mail Coupon for Sample Lesson and my FREE 64-page book. Read the details about my Course; letters from men I trained; see how quickly, easily you can get started. No obligation! Just MAIL COUPON NOW in envelope or paste on penny postal. J. E. SMITH, President, Dept. 7NP3 National Radio Institute, Pioneer Home Study Radio School, Washington 9, D. C.

Our 33rd Year of Training
Men for Success in Radio

MAIL NOW!

Mr. J. E. SMITH, President, Dept. 7NP3
National Radio Institute,
Washington 9, D. C.

Mail me FREE, your Sample Lesson
and 64-page book. (No salesman
will call. Please write plainly.)

Age.....

Name.....

Address.....

City..... State.....

(Please include Post Office zone number)

Approved for Training under GI Bill





AS ABOVE —

— SO BELOW

IS MAN A SMALL UNIVERSE?

IT HAS BEEN SAID that everything in the universe has its counterpart in man. What of your solar plexus? Does it link you with the world beyond . . . the vast cosmos of which earth is but a speck? Centuries ago, man observed that something in the center of his torso responded to his emotional excitements — joy, fear, elation, fright, sudden experiences. In seeking an explanation, there followed many more *amazing* discoveries. What did these ancient searchers for truth uncover? Did they learn how to draw energy to their emotional centers — for performing miracles and accomplishing feats that seemed impossible to the uninitiated?

WHAT ABOUT YOU?

Are you perfectly satisfied with your position in life? Are you enjoying life to its fullest extent? — truly abundantly? If obstacles seem to prevent you from attaining the heights and enjoying the better things in life, you are not using the powers that reside *within you*.

ACCEPT THIS FREE BOOK

Let the Rosicrucians (NOT a religious organization), a progressive, practical brotherhood, explain to you the simple, *demonstrable* laws governing your inner powers. Write for your FREE copy of, *The Mastery of Life*, which tells how easily you can come to possess tested methods for understanding the powers of personal accomplishment. Send coupon today!

Scribe J. J. X.
The Rosicrucians (AMORC)
San Jose, California

I am a sincere seeker. Please send me a copy of *The Mastery of Life*, which I shall read carefully.

Name _____

Address _____

Zone Number _____ State _____

The ROSICRUCIANS (AMORC) San Jose, California

Get Training *QUICK* in the Great Shops of **COYNE**



Learn
ELECTRICITY
in
a few
weeks

NOT a "Home-Study" Course!

Practical training pays! Thousands of successful electricians—men earning good money, with steady jobs and a real future—recommend the COYNE Shops in Chicago. We do not teach by mail. All instruction is given in our own big building in the heart of the World's Electrical Center. You make rapid strides here because it's a **shop** course.

Work on Full-Size Equipment!

In our great shops you actually operate, test, repair the same kinds of electrical apparatus you'll use later on the job. You do **REAL** house wiring; rewind **REAL** armatures; run a **REAL** switchboard. All this plus needed theory makes it easy to learn Electricity in a few short weeks here at COYNE.

No Experience Necessary

Many Coyne students have never had previous electrical experience. Others have had a smattering of it in one or two branches, but realize their need for "All-Around" training. We not only train you for a good job, we help you get it. Lifetime Free Employment Service to Coyne graduates.

SEND FOR FREE BOOK

Yours for the asking—big 40-page book on Coyne Electrical Training. Filled with fascinating pictures of our great shops and our plans to help you. Get your copy free. No cost or obligation; no salesman will call. Mail the coupon today!

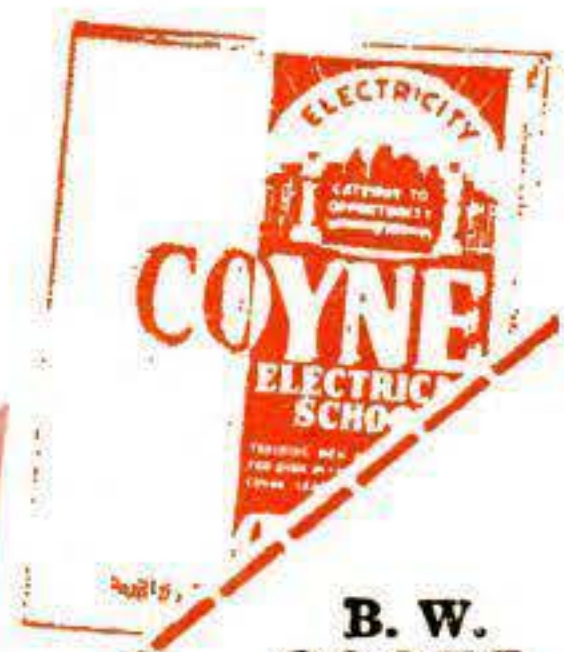

COYNE Shop Training Includes:

Alarm and Signal Work
D.C. Motors, Generators, Controls
A.C. Motors, Generators, Controls
House Wiring
Armature Winding
Stator Winding

Transformers
Switchboards
Home Appliances
—and many other branches including added training in **Industrial Electronics and Electric Refrigeration.**

NOW IN OUR 49th SUCCESSFUL YEAR



B. W. Cooke

Since 1899, Coyne has been training men and young men for practical, better-paying jobs. Here in our great Chicago Shops you will find the equipment, the friendly expert instructors, to prepare you for a real future in Electricity. Coyne graduates are in demand by many leading electrical firms. Coyne men are trained to make good in their own electrical shops. Come to COYNE!

VETERANS!
Coyne is authorized to accept Veterans for G. I. training. Coupon brings special G. I. Bulletin.

NON-VETERANS who are short of cash can finance most of their tuition and pay it in easy monthly payments after graduation. Many students earn while learning. We'll help you get part-time work while here if you need it to help defray living expenses.

ANY MAN WITH A PHYSICAL DISABILITY whether a Veteran or not may qualify for Coyne training at no cost to himself for tuition or subsistence. Send coupon for details.

COYNE **ELECTRICAL SCHOOL**
Dept. 97-73,
500 S. Paulina St., Chicago 12, Ill.

B. W. COOKE,
President,
COYNE ELECTRICAL SCHOOL,
Dept. 97-73,
500 S. Paulina St.,
Chicago 12, Illinois.

Send me your Free Book and tell me about your plans to help me—including Student Finance and added Training in Industrial Electronics and Electric Refrigeration. Mail coupon today.

NAME.....

ADDRESS.....

CITY.....STATE.....



I'll Send You 8 Big Kits of Training Equipment including
TWO-BAND 6 TUBE SUPER RECEIVER
AND 16 RANGE METER SET-UP
for Testing

Learn Fast . . . Earn Fast
HOME TRAINING
Planned For Your Needs
You Build All These
TESTERS . . . and MORE!



I give you a fine, moving-coil type Meter Instrument on Jewel Bearings—with parts for a complete Analyzer Circuit Continuity Tester. You learn how to check and correct Receiver defects with professional speed and accuracy.

Practice Does It!
 Soldering, wiring, connecting Radio Parts . . . building circuits with your own hands—you can't beat this method of learning. When you construct this Rectifier and Filter Resistor and Condenser Tester, etc., you get a really practical slant on Radio that leads to a money-making future.

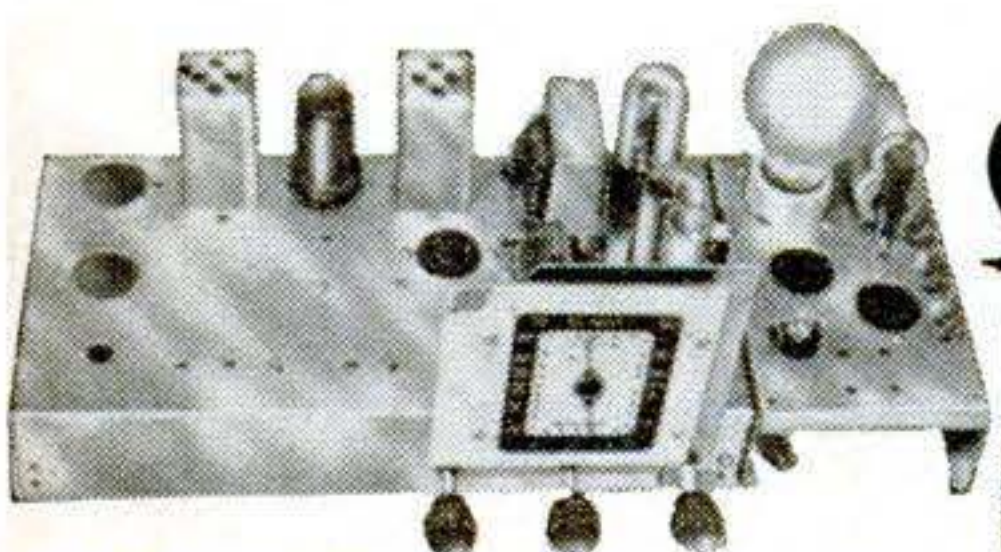
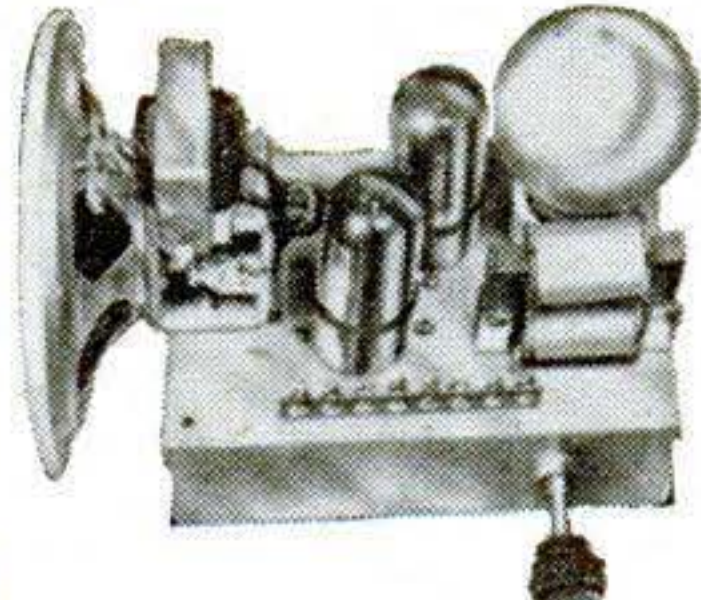

Building this Signal Generator and multi-purpose Tester will give you the kind of valuable experience and practice that is so important as a foundation for making good money in Radio. It makes a breeze out of fixing Radios, and you don't have to spend money on ready-made Equipment.

VETERANS
 Approved for G. I. Training
 Under Public Laws 16 and 346.

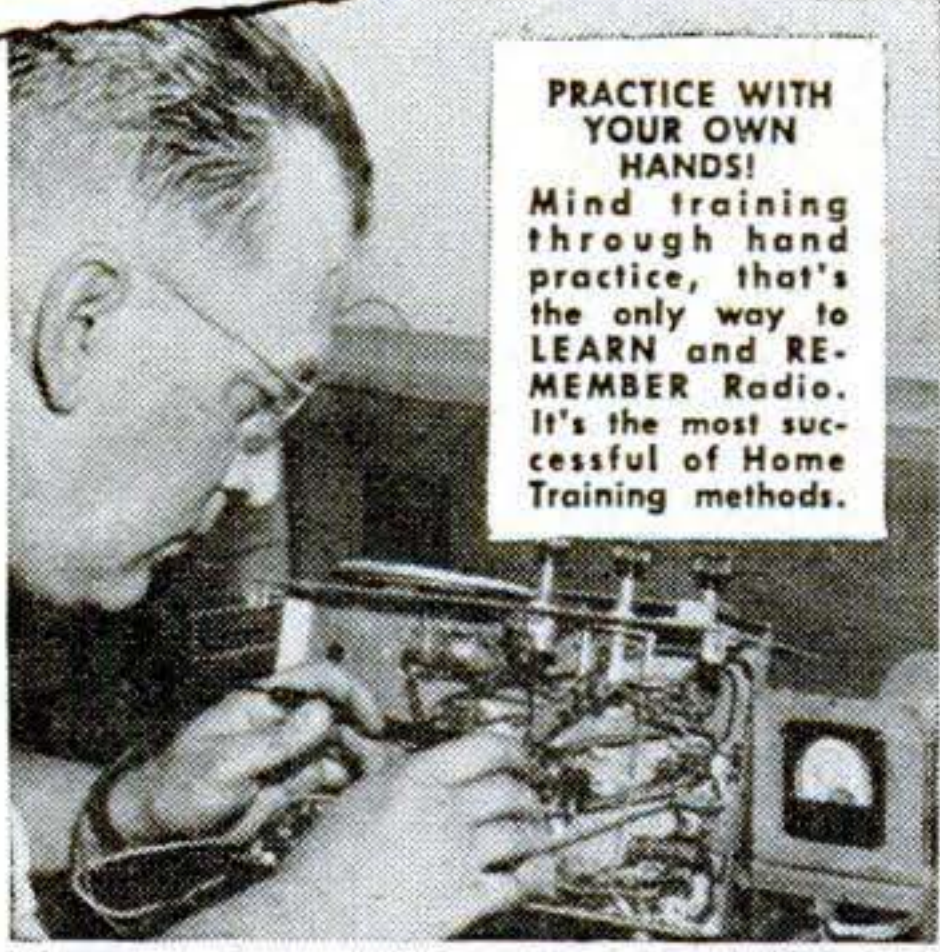

PRACTICE WITH YOUR OWN HANDS!
 Mind training through hand practice, that's the only way to LEARN and REMEMBER Radio. It's the most successful of Home Training methods.

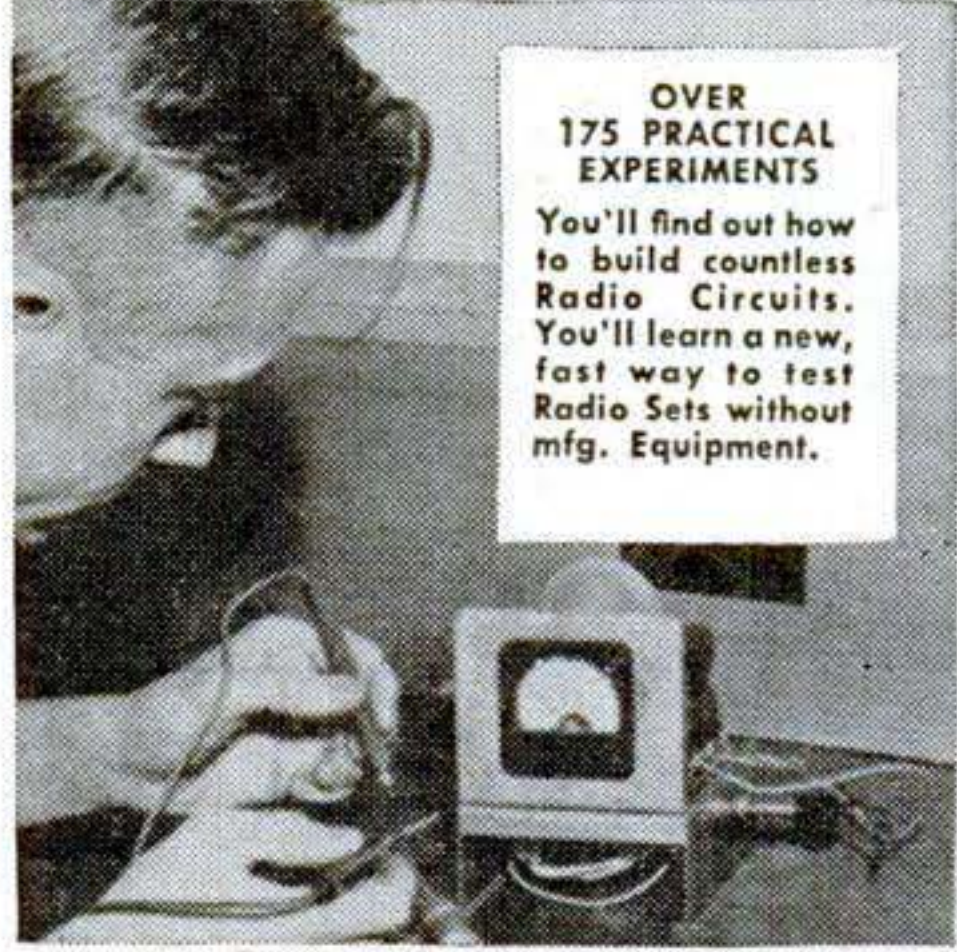

OVER 175 PRACTICAL EXPERIMENTS
 You'll find out how to build countless Radio Circuits. You'll learn a new, fast way to test Radio Sets without mfg. Equipment.

LOW COST HOME RADIO TRAINING!
Easy Monthly Payments!

My perfected Radio Training prepares you to start your own Radio Service Shop—or to land a big pay Radio job. With my help you get neighborhood Radio jobs while learning—for extra cash and rich experience. I train you RIGHT—by putting you to work with your hands in your own home during spare hours. You get 8 big kits of real professional Radio Parts and Equipment—and use them to build, test and trouble-shoot a powerful 6 tube superhet receiver, a 16 range test meter set-up and over 175 fascinating, instructive Radio experiments. My Training is down-to-earth, really PRACTICAL—it's the Training

you need to make money in Radio. Theory is cut to the bone—you don't need any previous schooling or experience. Sprayberry Training starts you out at the very beginning of Radio—the lessons are completely illustrated, simply written and easy to understand. Get the facts about Sprayberry Training NOW. Find out what it can do for you—prepare for amazing opportunities in Radio Servicing, Television, FM, Radar and Industrial Electronics. Fill out and mail coupon for my two big Books—FREE. No obligation—and no salesman will call. Mail coupon TODAY!

MAIL COUPON FOR THESE 2 BOOKS!



"How to Read Radio Diagrams and Symbols" and "How to Make Money in Radio, Electronics and Television." Immense, practical value to you — and they're yours FREE!

SPRAYBERRY ACADEMY OF RADIO
 F. L. Sprayberry, President
 Room 55127, Pueblo, Colorado

Please rush my FREE copies of "How to MAKE MONEY in RADIO, ELECTRONICS and TELEVISION" and "How to READ RADIO DIAGRAMS and SYMBOLS."

Check here if a Veteran.

Name _____ Age _____

Address _____

City _____ State _____

(Mail in envelope or paste on penny postcard)



INVENTORS



Learn how to protect your invention. The U. S. Patent Laws provide that any new and useful art, machine, article of manufacture, or composition of matter, or any new and useful improvement thereof, may be patented if the act of invention is involved. Therefore, every inventor with a valuable invention should take advantage of the Patent Laws and proceed for patent protection in order to safeguard his rights.

A patent gives the inventor the exclusive right to prevent others from making, using, or selling the invention claimed in the patent for a period of seventeen years.

The Patent Laws were enacted for the benefit of the inventor to give him protection for the features of his invention which are patentable. These features must be properly and concisely set forth and claimed in a formal application for patent, in order to comply with the requirements of the U. S. Patent Office. For that reason, the Patent Office advises the inventor, unless he is familiar with such matters, to engage a competent registered patent attorney or agent to represent him. We maintain a staff of registered patent attorneys ready to serve you in the handling of your patent matters.

A specially prepared booklet entitled "Patent Guide for the Inventor", containing detailed information with respect to patent protection and procedure, together with a "Record of Invention" form will be promptly forwarded to you without obligation upon request.

Patents

Trademarks

Copyrights

Registered Patent Attorneys

**CLARENCE A. O'BRIEN
& HARVEY B. JACOBSON**

72-M District National Building + Washington 5, D. C.

CLARENCE A. O'BRIEN & HARVEY B. JACOBSON
Registered Patent Attorneys
72-M District National Bldg., Washington 5, D. C.

Please send me copy of "Patent Guide for the Inventor"
and also "Record of Invention" form. This request does
not obligate me.

Name _____

Address _____

City _____ State _____

(Please write or print plainly.)

Here is why
PYROIL
 helps you to a
QUICK
START

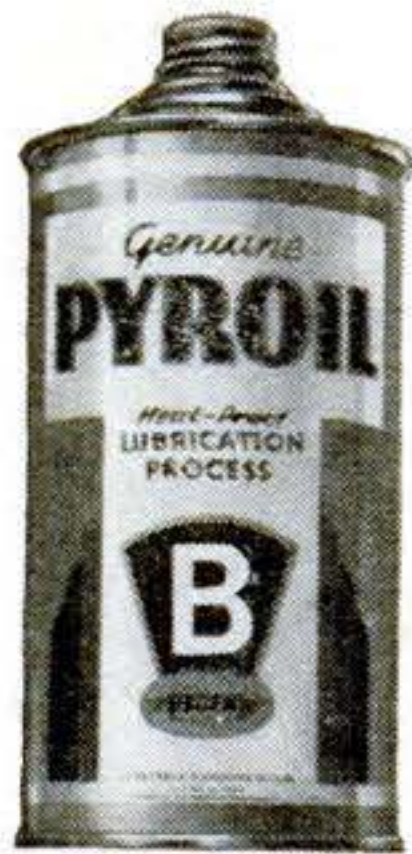

When you change to winter oil, you are changing to a low viscosity oil which helps cold weather starting. However, once you start, your engine temperatures are practically the same as summer temperatures. When you stop, the low viscosity oils quickly drain off cylinder walls leaving them dry. Starting again introduces the extra load of friction and the wear attendant to dry starts.

Pyroil gives oil the property of *clinging* to cylinder walls, permitting quick, easy starting *on lubricated surfaces* and reducing wear and corrosion.

Pyroil-better driving is easy to get. Simply ask your station attendant to add Pyroil—and add miles to your car.

Pyroil for Aircraft Engines

Use Aircraft Pyroil B for lubricating oil, Aircraft Pyroil A for gasoline.

*Manufactured and Guaranteed by Pyroil Company,
 275 Main Street, La Crosse, Wisconsin.*

*Canadian Distributors:
 Central Purchasing Agencies, Ltd., Toronto, Ontario*

PYROIL COMPANY

275 Main Street, La Crosse, Wisconsin

I want my car to last and run properly. Please tell me more about Pyroil and how it can accomplish this for me.

Name.....

Address.....

City or Town.....State.....



LETTERS

More than One Way

Sir:

In your excellent article, "Taming the Turbojets," (Oct., p. 82) you state that air is bled from the compressor, routed around the engine, and burned in the tailpipe.

As I understand it, the bled air is not routed around the engine, but is ducted beneath the burners and splashed against the turbine disk face to cool it. . . .

JOHN M. GASKA

Amsterdam, N. Y.

Both Mr. Gaska and PSM are right. The different systems are just two of a number of variations in gas-turbine design that at some time or another have been tried.

Praise from a Neighbor

Sir:

May I take the opportunity to congratulate Mr. Stevenson on his fine article on motorcycles in the August issue (p. 138).

I am contemplating a tour around the world on a motorcycle next year, and the Jawa motorcycle attracted my attention as being the ideal bike for such a trip because of its simplicity and the low upkeep characteristic of two-cycle engines, . . .

GORDON LING

Belleville, Ontario

Seeing Isn't Believing

Sir:

There are no windshield posts on the station wagon described on page 154 of the September issue. . . . The roof is entirely self-supporting. . . .

PAUL STANLEY
 Queensway Motors

Queensway, London

Call them what you will, the side edges of the windshield frame still look like narrow posts, supporting or otherwise.

INVENTORS

Patent Laws Encourage The Development Of Inventions

The Rules of Practice of the U. S. Patent Office advises—unless an inventor is familiar with such matters—that he employ a competent registered attorney or registered agent, as the value of patents depends largely upon the skillful preparation of the specifications and claims.

The firm of McMorrow, Berman and Davidson is registered to practice before the U. S. Patent Office. Additionally, it maintains a staff of attorneys able to readily understand inventors' disclosures, to advise concerning patentability, and to prepare appropriate specifications and claims for filing with the Patent Office.

If an inventor believes he has an invention, a search of the most pertinent prior U. S. patents should be made and a report obtained relative to its patentability. Where such report indicates that the invention appears patentable, in order to secure protection, diligence should be exercised in making application for a patent.

McMORROW, BERMAN & DAVIDSON

Registered Patent Attorneys

PATENTS — TRADE MARKS — COPYRIGHTS

142-B VICTOR BUILDING, WASHINGTON 1, D. C.

McMORROW, BERMAN & DAVIDSON

Registered Patent Attorneys

142-B Victor Building, Washington 1, D. C.

Send me further particulars as to patent protection and procedure and "Invention Record" form at once. I understand that this request does not obligate me.

Name.....

Address.....

City..... State.....

(WRITE OR PRINT NAME CLEARLY)

SUCCESS BRINGS

THE GOOD THINGS OF LIFE



FIND OUT ABOUT OPPORTUNITIES IN INDUSTRIAL ELECTRONICS

It's a perfectly natural human desire to want more money, a better job, prestige and all the other good things of life. Who gets them? Look about you. Success you will see, comes to the man who is trained for his job.

A new world of opportunity is today beckoning to ambitious men. One of the most important and exciting fields is **INDUSTRIAL ELECTRONICS**. It is attracting experienced electrical men as well as younger fellows seeking a way to bigger earnings and a more secure future.

OPPORTUNITY LIES AHEAD

Industrial Electronics is not Radio. It has nothing to do with radio transmitters and receivers. It is totally new application of electric power, applied to modern production by means of the magic of the vacuum tube. Everywhere industrial electronic devices are replacing the old-time electrical controls, and processes. Industrial Electronics is Modern Industrial Electricity.

"Every electrician should know—must know—Industrial Electronics." That's what many Union leaders are telling their members, today. They know that the use of Industrial Electronics devices is growing by leaps and bounds. They know that to install and service this equipment, even the best of present-day electricians must first have had special training.

GET READY NOW!

Now is the time to get into Industrial Electronics, while the field is in its infancy . . . and while it is rapidly developing a need for thousands of trained experts. Tomorrow's leaders are training today. And here is a School equipped in every way to train you for Industrial Electronics work—one of the largest and most completely equipped, and one of the few of its kind in America—a School that already has trained thousands of men for industrial opportunities.

LEARN AT HOME OR COME TO OUR SCHOOL

Learn Industrial Electronics—now, while the time is ripe. You don't need any advanced schooling or previous experience. If you are at all mechanically inclined and have gone to high school for at least one year or have an equivalent education, we can teach you Industrial Electronics.

You can take most of your training at home, in your spare time—or you can come to Chicago and take your entire training in our completely equipped shops and laboratories. Either way you quickly acquire the fine points, practical skill, and broad, technical "know how" that makes the expert Industrial Electronics Technician.

A GUIDE FOR YOUR FUTURE—Complete facts about Industrial Electronics. Packed with pictures. Tells all about our successful training plan. Coupon will also bring details about moneymaking opportunities for trained men and our Life-Time Free Employment Service. No obligation. Mail coupon TODAY. Investigation may start you up the ladder of Success.

AUTHORIZED TO ACCEPT VETERANS FOR G.I. TRAINING

INDUSTRIAL TRAINING INSTITUTE,
2150 Lawrence Ave., Dept. P2ML Chicago 25, Ill.

Please send me, FREE, your "Camera Visit" booklet and information about the opportunity for trained men in **INDUSTRIAL ELECTRONICS**. It is understood that I will be under no obligation.

NAME.....

ADDRESS.....

CITY.....STATE.....

ARE YOU A VETERAN?.....

SEND FOR THIS BOOK —IT'S FREE



GET THE FACTS ABOUT AMERICA'S FOREMOST SCHOOL OF PRACTICAL TRAINING.



Pellets Get a Pelting

Sir:

Pictured at the top of page 102 ("Rain of Seeds Brings Desert Back to Life," PSM, Sept. '46) is some love grass planted in 1945. As 1946 is the only year mentioned for the airplane seeding, I assume the grass in the picture was planted by a conventional method. Am I right?

It's several years since I have experienced a good hailstorm, but my recollection is that the stones mostly bounce when they hit the ground. . . . I can believe that the pellets might embed themselves in mud, but can they actually puncture the desert pavement?

And finally, I wonder how the cost of this project is justified on almost worthless land. . . . If this is for the benefit of the Indians, perhaps there would be less uncertainty and more economy in distributing the taxpayers' dollars directly over the reservation. . . .

D. JOHNSTON

Oak, Neb.

To answer Mr. Johnston's questions, PSM called upon Clifton Abbott, from whom it procured the original story. Here is Mr. Abbott's reply:

Sir:

As *Popular Science Monthly* said, the grass shown was a "test plot" and was not the result of pellet planting. . . . Test plots are relatively small, never more than a few square feet. They are hand-sown. . . .

The purpose of the pellet material is twofold: to give the seeds sufficient weight to drop directly to the earth without scattering, and to surround them with earth, fertilizer, insecticide and rodenticide so that 99 percent germination will be assured. . . .

Since this eliminates the necessity of burying the seeds, the use of "penetration" is probably an unhappy word choice.

As for the land's worthlessness, it is poor only because it does not grow enough grass to support livestock. In the winter, Army planes have had to drop taxpayers' money over Indian reservations in the form of food and blankets to lessen cold and hunger. Had the land been capable of supporting sheep and cattle, this expense would not have been necessary. . . .

In past years billions of dollars have been spent on dams in Arizona and the South-

YOUR FUTURE IS PLASTIC-



ANYTHING capable of being molded is plastic. So it's a word that applies to your future as well as to the materials of the plastics industry. There are giant possibilities in this field. Their realization depends upon the planning of *trained* men.

Within **YOU**, too, are great possibilities. Their realization depends upon your being a *trained* man. The world-famous International Correspondence Schools offer you

the opportunity to obtain that *training* in your spare time, at low cost.

With *training*, you can mold your place in the new world to your heart's desire. A more responsible job, higher pay — whatever you want is attainable if you qualify as an *expert*.

The time to qualify — in plastics or any other industry—is **NOW**. Mail the coupon today and let I. C. S. tell you how!

INTERNATIONAL CORRESPONDENCE SCHOOLS



BOX 7698-L, SCRANTON 9, PENNA.

Without cost or obligation, please send me full particulars about the course BEFORE which I have marked X:

- | | | | |
|--|---|---|--|
| <p>Air Conditioning and Plumbing Courses</p> <p><input type="checkbox"/> Air Conditioning
<input type="checkbox"/> Heating
<input type="checkbox"/> Refrigeration
<input type="checkbox"/> Plumbing
<input type="checkbox"/> Steam Fitting</p> <p>Chemistry Courses</p> <p><input type="checkbox"/> Chemical Engineering
<input type="checkbox"/> Chemistry, Analytical
<input type="checkbox"/> Chemistry, Industrial
<input type="checkbox"/> Chemistry, Mfg. Iron & Steel
<input type="checkbox"/> Petroleum Refining
<input type="checkbox"/> Plastics
<input type="checkbox"/> Pulp and Paper Making</p> <p>Civil Engineering, Architectural and Mining Courses</p> <p><input type="checkbox"/> Architecture
<input type="checkbox"/> Architectural Drafting
<input type="checkbox"/> Bridge and Building Foreman
<input type="checkbox"/> Building Estimating
<input type="checkbox"/> Civil Engineering
<input type="checkbox"/> Coal Mining
<input type="checkbox"/> Contracting and Building
<input type="checkbox"/> Highway Engineering
<input type="checkbox"/> Lumber Dealer
<input type="checkbox"/> Reading Structural Blueprints
<input type="checkbox"/> Sanitary Engineering
<input type="checkbox"/> Structural Drafting</p> | <p><input type="checkbox"/> Structural Engineering
<input type="checkbox"/> Surveying and Mapping</p> <p>Communications Courses</p> <p><input type="checkbox"/> Electronics
<input type="checkbox"/> Practical Telephony
<input type="checkbox"/> Radio, General
<input type="checkbox"/> Radio Operating
<input type="checkbox"/> Radio Servicing
<input type="checkbox"/> Telegraph Engineering</p> <p>Electrical Courses</p> <p><input type="checkbox"/> Electrical Drafting
<input type="checkbox"/> Electrical Engineering
<input type="checkbox"/> Electric Light and Power
<input type="checkbox"/> Lighting Technician
<input type="checkbox"/> Practical Electrician</p> <p>Internal Combustion Engines Courses</p> <p><input type="checkbox"/> Auto Technician
<input type="checkbox"/> Diesel-Electric
<input type="checkbox"/> Diesel Engines
<input type="checkbox"/> Gas Engines
<input type="checkbox"/> Aviation
<input type="checkbox"/> Gas Engines</p> <p>Mechanical Courses</p> <p><input type="checkbox"/> Aeronautical Engineer's, Jr.
<input type="checkbox"/> Aircraft Drafting
<input type="checkbox"/> Flight Engineer
<input type="checkbox"/> Forging
<input type="checkbox"/> Foundry Work
<input type="checkbox"/> Heat Treatment of Metals</p> | <p><input type="checkbox"/> Industrial Engineering
<input type="checkbox"/> Industrial Metallurgy
<input type="checkbox"/> Machine Shop
<input type="checkbox"/> Mechanical Drafting
<input type="checkbox"/> Mechanical Engineering
<input type="checkbox"/> Mold-Loft Work
<input type="checkbox"/> Patternmaking—Wood, Metal
<input type="checkbox"/> Reading Shop Blueprints
<input type="checkbox"/> Sheet-Metal Drafting
<input type="checkbox"/> Sheet-Metal Worker
<input type="checkbox"/> Ship Drafting
<input type="checkbox"/> Ship Fitting
<input type="checkbox"/> Tool Designing
<input type="checkbox"/> Toolmaking
<input type="checkbox"/> Welding—Gas and Electric</p> <p>Railroad Courses</p> <p><input type="checkbox"/> Air Brake
<input type="checkbox"/> Diesel Locomotive
<input type="checkbox"/> Locomotive Engineer
<input type="checkbox"/> Locomotive Fireman
<input type="checkbox"/> Railroad Section Foreman
<input type="checkbox"/> Car Inspector</p> <p>Steam Engineering Courses</p> <p><input type="checkbox"/> Boilermaking
<input type="checkbox"/> Combustion Engineering
<input type="checkbox"/> Engine Running
<input type="checkbox"/> Marine Engineering
<input type="checkbox"/> Steam Electric
<input type="checkbox"/> Steam Engines</p> | <p>Textile Courses</p> <p><input type="checkbox"/> Cotton Manufacturing
<input type="checkbox"/> Rayon Weaving
<input type="checkbox"/> Textile Designing
<input type="checkbox"/> Woolen Manufacturing</p> <p>Business and Academic Courses</p> <p><input type="checkbox"/> Accounting
<input type="checkbox"/> Advertising
<input type="checkbox"/> Arithmetic
<input type="checkbox"/> Bookkeeping
<input type="checkbox"/> Business Administration
<input type="checkbox"/> Business Correspondence
<input type="checkbox"/> Certified Public Accounting
<input type="checkbox"/> Commercial
<input type="checkbox"/> Commercial Art
<input type="checkbox"/> Cost Accounting
<input type="checkbox"/> Federal Tax
<input type="checkbox"/> First Year College
<input type="checkbox"/> Foremanship
<input type="checkbox"/> French
<input type="checkbox"/> Good English
<input type="checkbox"/> High School
<input type="checkbox"/> Higher Mathematics
<input type="checkbox"/> Motor Traffic
<input type="checkbox"/> Postal Service
<input type="checkbox"/> Salesmanship
<input type="checkbox"/> Secretarial
<input type="checkbox"/> Sign Lettering
<input type="checkbox"/> Spanish
<input type="checkbox"/> Stenography
<input type="checkbox"/> Traffic Management</p> |
|--|---|---|--|

Name _____ Home Address _____
 City _____ State _____
 Age _____ Present Position _____ Working Hours _____ A.M. to _____ P.M.

Special tuition rates to members of the Armed Forces.
 Canadian residents send coupon to International Correspondence Schools Canadian, Ltd., Montreal, Canada.

**FOUR CAREER
FIELDS**



**FOR YOUR
SUCCESS**

PLASTICS

WATCHMAKING

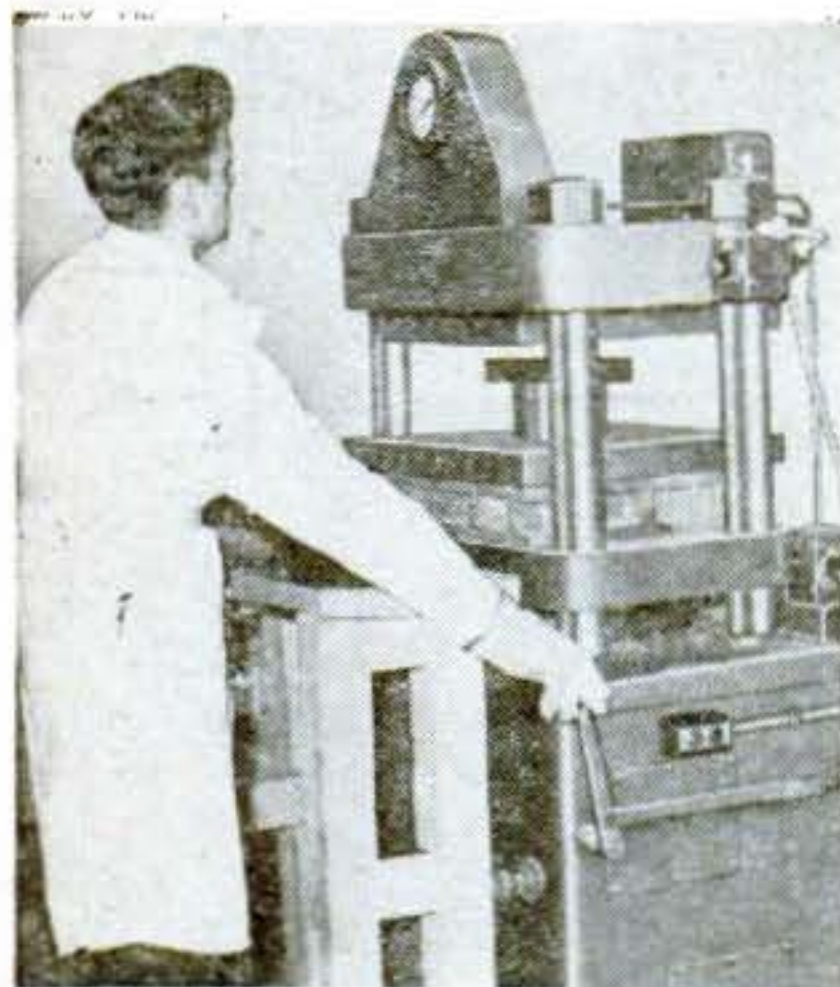

This student is learning to operate a hydraulic press used to mold thermo-setting plastics. Plastic Institute's modern laboratories and shops provide training facilities which are thoroughly practical!

PLASTICS AND YOUR FUTURE!

Decide to make your future career in some branch of Plastics. Then you've hitched your future to a young, growing industry. Why? Because more and more products are being made successfully from some type of plastic. Fabrics, poker chips, toys, kitchenware, lamp shades, radio cabinets,

fly rod containers, golf clubs and thousands more—useful, everyday products. This means a bigger industry, more jobs, more opportunities for men to operate their own business—**MORE OPPORTUNITIES FOR TRAINED PLASTICS MEN AND WOMEN.**

PLASTICS INSTITUTE is the oldest and largest training school devoted entirely to Plastics education. Headed by widely known leaders in the Plastics Industry, the complete training program, both **HOME STUDY AND RESIDENT SCHOOL**, has been carefully designed to equip men and women to enter the Plastics Industry with the knowledge necessary to get ahead.



GET KIT OF PLASTIC MATERIALS

You receive practical experience making useful, attractive articles as part of your Home Study training. Many students have earned money selling articles of their own manufacture. It's creative and exciting.

GET FREE LITERATURE. MAIL COUPON TODAY.

See what Plastics Industries Technical Institute offers you and read what many successful graduates say about their training. Mail coupon below for complete information. Be sure to indicate whether you are interested in **HOME TRAINING** or desire to come to Los Angeles, California, for resident training.

Approved for Veterans—Non-Veterans

Plastics Industries Technical Institute
Dept. PS-4-12-7, 1601 S. Western Ave., Los Angeles 6, Calif.
Gentlemen: Please send me free literature and information on your practical courses. I am interested in Home Training attending school in Los Angeles .

Name (Print)

Street.....Age.....

City.....Zone.....State.....

Veteran.....Non-Veteran.....

- What **TIME** do you get up?
- What **TIME** do you go to work?
- What **TIME** does your train leave?
- What **TIME** do you eat lunch?
- What **TIME** does the game start?
- What **TIME** do you have dinner?
- What **TIME** does the movie start?

Everyone is guided by **TIME**. That is the reason why it is important for you to seriously consider **WATCHMAKING** as your career. This interesting field demands trained minds and hands. You can get this training at American School of Watchmaking.



At American School of Watchmaking students get the best of training under the careful supervision of expert instructors.

YOUR OWN BUSINESS

Trained men and women in Watchmaking can get into business for themselves, or work for good pay in pleasant surroundings. Many students of **AMERICAN SCHOOL OF WATCHMAKING** are achieving success in this profitable field.

STUDY IN GLAMOROUS CALIFORNIA

Enroll in American School of Watchmaking and combine your serious training program with all that Southern California offers you.

Member of: United Horological Association
National Council Technical Schools

Approved for Veterans—Non-Veterans

American School of Watchmaking
Dept. PS-4-12-7, 5145 W. San Fernando Rd.
Los Angeles 26, Calif.

Gentlemen: Please send me free booklet and information on your training.

Name (Print)

Street.....Age.....

City.....Zone.....State.....

Veteran.....Non-Veteran.....

CHOOSE THE ONE



THAT FITS YOU BEST

DIESEL

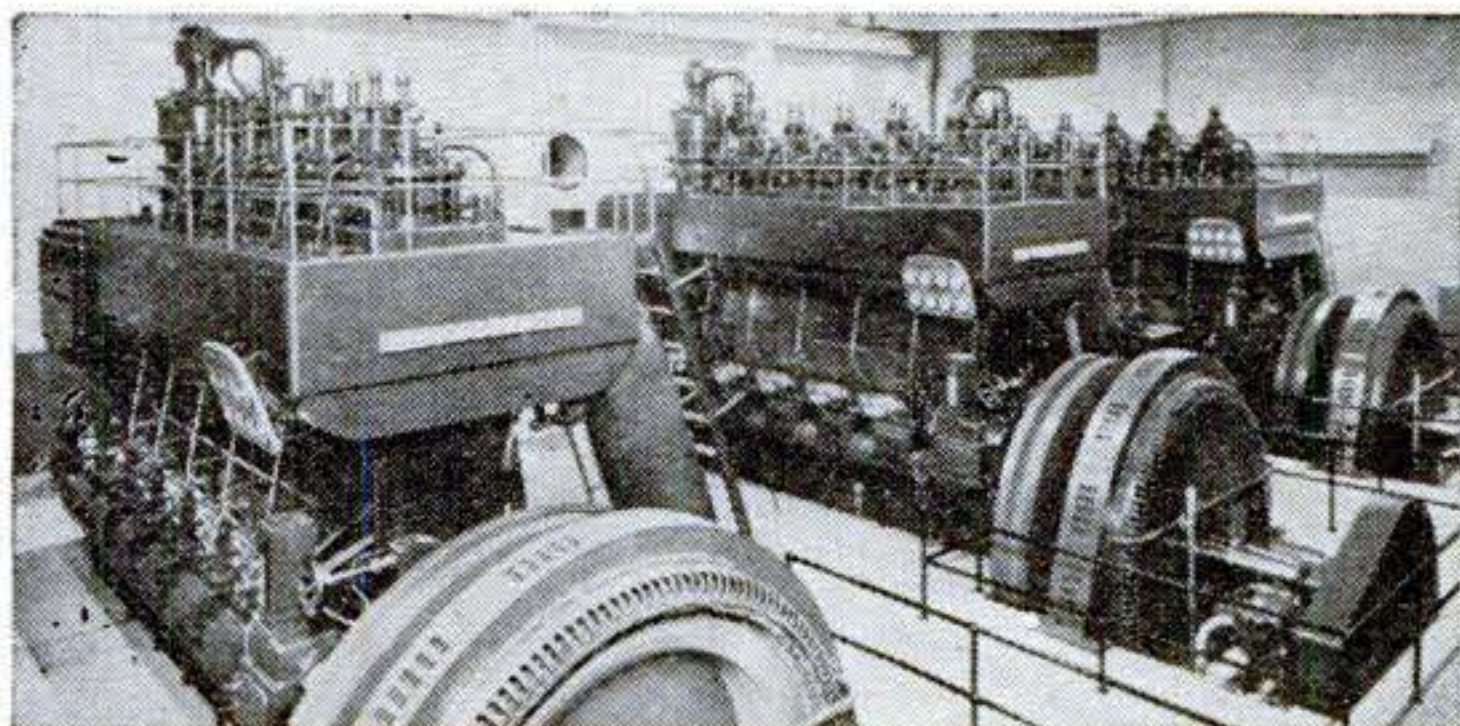

A typical modern Diesel plant.

If you are mechanically inclined and ambitious to get into a field offering a great future—then **LEARN DIESEL THE HEMPHILL WAY!** Many successful Hemphill School graduates have positions of responsibility operating, installing, repairing, and servicing Diesel engines in trucks, ships, power plants, logging operations, construction jobs and other fields. The scope and future of the trained Diesel man is broad and offers opportunities to specialize. If you want to see the world, remember, Diesels are used in transportation, mining, construction and drilling operations in distant countries. Perhaps you like agriculture or railroading or shipping—in almost every field you find Diesels. And remember, trained Diesel men are required to operate and maintain them. **YOU CAN BE A TRAINED DIESEL MAN.** You can learn quickly and easily the famous **HEMPHILL WAY!**

STUDY AT HOME

Learn Diesel at home in your spare time, without interfering with your present activities. Easy-to-understand **HOME STUDY** course result of years of Hemphill Schools' successful teaching. Or take practical resident school training at Los Angeles, New York or Memphis. **INDICATE YOUR CHOICE ON COUPON BELOW.**

Hemphill Specialized Automotive Engine, Carburetor, Electrical and Ignition Tune-up Course offered at Los Angeles and Memphis. Check coupon.

Approved for Veterans—Non-Veterans

.....

Hemphill Diesel and Automotive Schools
Administrative Office: 1601 South Western Ave.
Dept. PS 4-12-7, Los Angeles 6, California

Gentlemen: Please send me **FREE BOOKLET** and information on your Diesel Courses. I am interested in Home study Resident School at New York Memphis Los Angeles Send information on Auto Tune-up at Memphis Los Angeles

Name.....Age.....

Street.....Zone.....

City.....State.....

Veteran.....Non-Veteran.....

AIRCRAFT INSTRUMENTS



After overhauling a Rate of Climb Indicator, student tests it for proper range deflection, maintaining very rigid tolerances, on a special test unit.



This student is testing for accuracy a Turn and Bank Indicator against time, using a stop watch, and against another instrument of known accuracy.

FLASH! C-54 four-engined Skymaster, known as "The Big Push" flies Atlantic without a hand on the controls!

Delicate INSTRUMENTS made this feat possible! **TRAINED AIRCRAFT INSTRUMENT TECHNICIANS** manufactured, installed and serviced these instruments. Such men are essential to the continuing progress of Aviation!

GET INTO THIS IMPORTANT FIELD!

American Schools of Aircraft Instruments teaches you in 34 short weeks to qualify as an Instrument Technician. Hundreds of successful graduates employed in the industry or have own business.

HERE'S WHAT YOU LEARN

At A.S.A.I. you study instruments in pressure, mechanical and gyroscopic groups. Installation, service, repair and line maintenance. Aircraft instrument training also applicable to many industrial fields.

Come to American Schools of Aircraft Instruments in Los Angeles where much Aviation history begins and where you can enjoy all else that Southern California offers you.

Approved by National Council of Technical Schools. C.A.A. approved Instrument Repair Station License No. 1028.

Approved for Veterans—Non-Veterans

.....

American Schools of Aircraft Instruments
Dept. PS 4-12-7, 5145 W. San Fernando Rd.
Los Angeles 26, Calif.

Gentlemen: Please send me **FREE** and **WITHOUT OBLIGATION**, illustrated booklet describing Aircraft Instrument field.

Name (Print).....

Street.....Age.....

City.....Zone.....State.....

Veteran.....Non-Veteran.....



**Get into the busiest,
most profitable part
of the electrical
repair business!**

Learn to Service and Repair all Kinds of ELECTRIC MOTORS

HERE'S REAL OPPORTUNITY!

Think of it! The average small home has 11 motors. Big homes have many more. They're in phonographs, recorders, oil burners, refrigerators, fans, clocks, mixers, washers, cleaners, etc. Millions more in office and industrial equipment. No wonder the motor repair expert is busy and well paid!

AN UNCROWDED BIG-PAY FIELD

Now! **ELECTRIC MOTOR REPAIR**, the unique 570-page training book for beginners makes it easy for you to study at home for fast, profitable service on *practically any motor in common use*. The opportunities are tremendous. There are more motors than any other type of electric appliance. This big, easily understood book can help you to be the well-paid expert who can repair them. As clearly as A-B-C, it shows you how to do every phase of the work from minor repairs and adjustments to complete armature rewinding.

LEARN FAST—PRACTICE AT HOME No previous training needed

ELECTRIC MOTOR REPAIR is ideal for spare time home study. Every step is explained in text and demonstrated visually by more than 900 special illustrations. Like a teacher standing by your side, it tells exactly what to do—exactly how to do it. Best of all, it covers BOTH a-c and d-c motors, universal motors, synchronous motors and generators, etc., etc. and BOTH mechanical and electric motor control systems. Quick reference guides show exactly how to handle specific jobs. Hundreds of motor repair shops find the book an invaluable working guide and an ideal means of training beginners. Unique Duo-Spiral Binding divides book into 2 sections so that both text and related illustration can be studied together.



**"BORROW" IT FOR
5 FULL DAYS!**

Send coupon at once! Practice from **ELECTRIC MOTOR REPAIR** for 5 full days. See how interesting the work is—how rapidly and completely it can now be learned. Then, if not more than satisfied return book and your money will be refunded at once! You cannot lose!

YOU CAN'T LOSE ON THIS OFFER!

Dept. PS-127, **MURRAY HILL BOOKS, Inc.**
232 Madison Ave., New York 16, N. Y.

Send me a copy of "ELECTRIC MOTOR REPAIR" for which I enclose \$5 (\$5.50 foreign); or send C.O.D. (no foreign C.O.D.'s.) for this amount and I will pay postman \$5 plus postal charge when he delivers it to me. If this book is not what I need, I'll return it within 5 days and you guarantee to refund my \$5.

Name.....

Address.....

City & Zone..... State.....

west. They are rapidly filling with silt from eroded land. The annual cost of dredging them is many times greater than would be that of reseeding the entire United States by the air-planting method. . . .

CLIFTON ABBOTT

Tucson, Ariz.

Better Late than Never

Sir:

. . . I was a little startled when I read in a recent issue (PSM, June '47, p. 180) of a knock-down boat As long as I can remember—and I am now 28—these knock-down boats have been in common use here in Germany, especially in the region of the Alps

The craft can be packed so neatly that you can store it in any car or trailer or carry it on your back, bicycle or on the train. It was used on several expeditions in South America, Africa and the Arctic regions

When I went through some very old magazines of the years 1930 and 1931, I found several pictures and ads of this sport, which I am enclosing as proof

OSKAR SCHWARZ

Stuttgart, Germany



German versions of the folding boat have indeed been in use for many years, as Mr. Schwarz states. One of them is shown in action, circa 1931. The ubiquitous American automobile, however, has made it possible to transport full-sized boats, and the folding variety has remained more of a novelty in this country.

AUDELS REFRIGERATION & AIR CONDITIONING GUIDE.....\$4

New from Cover to Cover—1280 Pages, Fully Illus. Covering basic principles, servicing, operation & repair of household, commercial & industrial refrigeration & air conditioning. A gold mine of essential important facts for engineers, servicemen, users.

AUDELS CARPENTERS & BUILDERS GUIDES—4 Vols.\$6

A practical illustrated trade assistant on modern construction for carpenters, joiners, builders, mechanics and all woodworkers. 4 vols., 1600 pages, 3700 illustrations, flexible covers. Pocket size. Each volume sold separately \$1.50 a vol.

AUDELS AUTOMOBILE GUIDE.....\$4

A practical quick ready reference book for auto mechanics, service men, operators & owners. Explains theory, construction & servicing of modern motor cars, trucks, buses & auto type Diesel engines. 1700 pages, fully illustrated. 55 chapters. Indexed. A standard book for mechanics. New fluid drive covered.

AUDELS DIESEL ENGINE MANUAL..\$2

A practical, concise treatise with questions and answers on the theory, operation and maintenance of modern diesel engines including General Motors 2 cycle Diesel. 384 pages, fully illus., flexible binding, pocket size. All details plainly brought out, this book is of extreme value to engineers, operators & students.

AUDELS WIRING DIAGRAMS.....\$1

210 Pages. Illustrated. Gives practical facts on wiring of electrical apparatus. It shows clearly how to wire apparatus for practically all fields of electricity. Each diagram is complete & self-explanatory. Highly Endorsed Pocket Companion.

AUDELS PLUMBERS & STEAMFITTERS GUIDES—4 Vols.\$6

A Practical Trade Assistant & Ready Reference. Explains in plain language & by clear illustrations, diagrams, charts, graphs, pictures principles of modern plumbing practice including Marine Pipe Fitting and Air Conditioning. 4 Vols.—1670 Pages—3642 Diagrams. Pocket size. Each Vol. Sold Separately \$1.50 a Vol.

AUDELS SHEETMETAL WORKERS HANDY BOOK.....\$1

Practical inside information. Fundamentals of Sheet Metal Work. 388 pages. Illustrated. 11 sections. Clearly written. Essential & important facts, figures, pointers in everyday language. Ref. Index.

AUDELS SHEETMETAL PATTERN LAYOUTS.....\$4

Developed by Experts for Sheet Metal Workers, Layout Men & Mechanics. A Practical Encyclopedia in 10 Sections, size 7 x 10 x 2—1125 Pages—350 Layouts—1600 Illustrations. 1001 Key Facts. Fully indexed for ready reference in answering your layout problems. Covers all phases of sheet metal work including Pattern Cutting, Pattern Development & Shop Procedure.

AUDELS ANSWERS ON BLUE PRINT READING.....\$2

For Mechanics & Builders. Covers all types of blue print reading including ship & airplane. 416 pages, fully illustrated.

AUDELS NEW MACHINIST & TOOLMAKERS HANDY BOOK.....\$4

Covers modern machine shop practice in all its branches. 5 practical books in 1. New from cover to cover. Tells how to set up & operate lathes, screw and milling machines, shapers, drill presses and all other machine tools. 1600 pages, fully illustrated, 5 x 6 1/2 x 2. Indexed. 5 sections. 1—Modern Machine Shop Practice. 2—Blue Print Reading & How to Draw. 3—Calculations & Mathematics for Machinists. 4—Shop Physics. 5—How to Use the Slide Rule. 60 chapters. Easy to read and understand. A shop companion that answers your questions.

AUDELS MATHEMATICS & CALCULATIONS FOR MECHANICS \$2

Mathematics for home study or reference. 700 pages, 550 illus. Practical mathematics from beginning. How to figure correctly. Easy, correct methods covering complete review. Illus. & Indexed.

AUDELS HANDY BOOK OF PRACTICAL ELECTRICITY.....\$4

For maintenance engineers, electricians & all electrical workers. 1440 Pages, 2600 Illus. Covers important electrical information in handy form—including Marine Wiring, Radio Principles, Welding. Indexed. A Key to a practical understanding of electricity.

AUDELS RADIOMANS GUIDE.....\$4

A key to the practical understanding of radio including Frequency Modulation, Television, etc., Aircraft & Marine Radio. For radio engineers, servicemen, amateurs. 914 Pages, 633 Illustrations & Diagrams. Photos. Review Questions & Answers, Reference Index. Authentic, clear, concise.

AUDELS ELECTRONIC DEVICES.....\$2

Tells What You Want to Know About Electric Eye. Easily Understood. Covers photo-electric cells & their applications. Amplifiers, illumination, frequencies, voltage, photocell, tubes, Ohm's Law, wiring diagrams, etc.

AUDELS WELDERS GUIDE.....\$1

A concise, practical text on operation & maintenance of all welding machines for all mechanics. Over 400 pages, illustrated. Covers all methods of electric and acetylene welding including airplane work.

AUDEL, Publishers, 49 W. 23 St., N. Y. 10

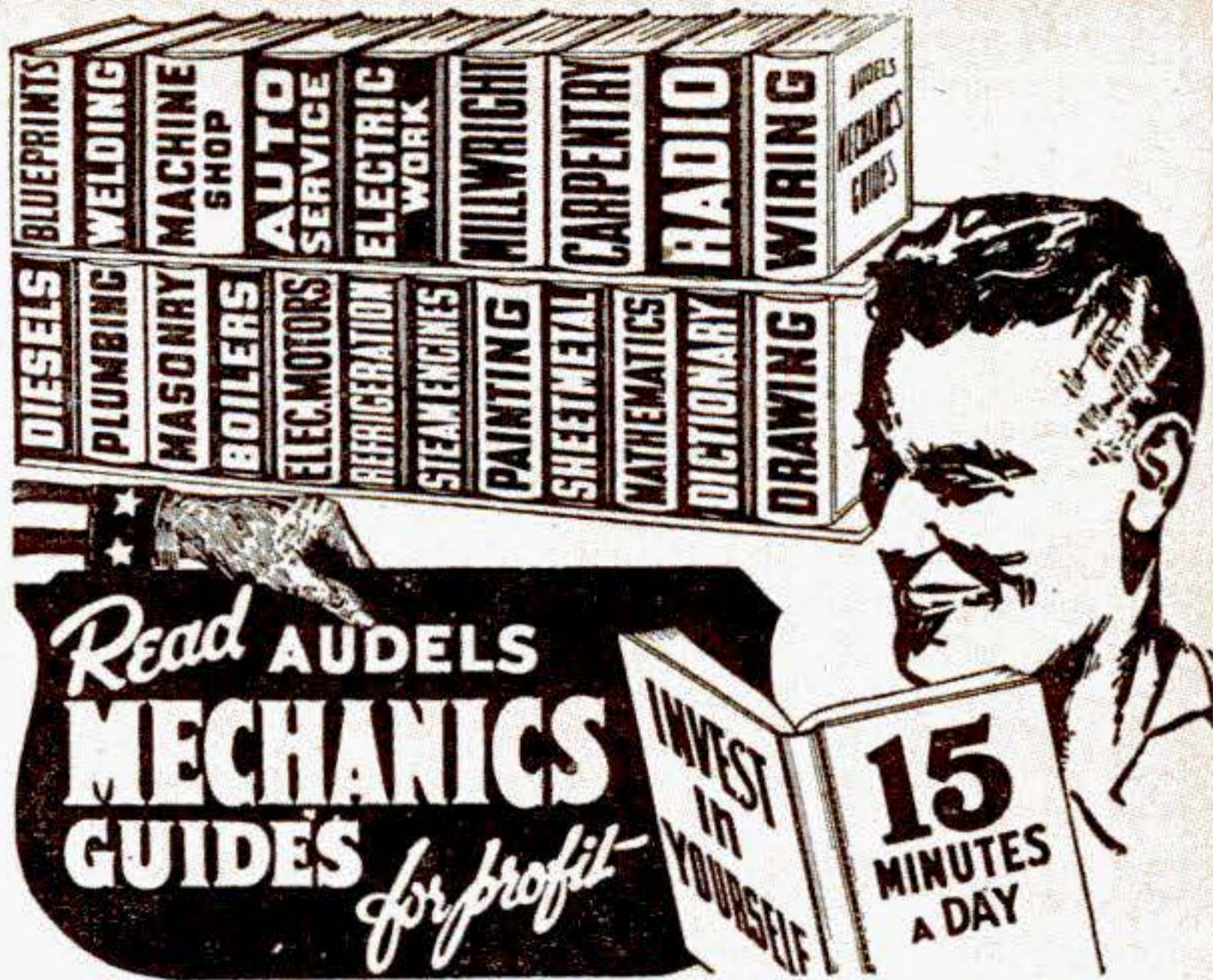

AN AUDEL GUIDE IS A GOOD FRIEND!

Step Up Your Own Skill with the Practical Facts and Figures of Your Trade. Save time and money with right methods, short cuts, labor saving ideas. CHECK NOW! You can look over any Audel Guide in your home. Start the Easy Payments if satisfied.

CUT HERE MAIL ORDER

THEO. AUDEL & CO., 49 W. 23 St., New York 10, N. Y.

Please mail me for 7 days' free examination the books marked (X) below. I agree to mail \$1 in 7 days on each book or set ordered, and to further mail \$1 a month on each book or set ordered until I have paid purchase price.

If I am not satisfied with Guides I will return them.

- Audels **ELECTRIC MOTOR GUIDE** \$4.
- Audels **OIL BURNER GUIDE** 1.
- Audels **REFRIGERATION & Air Conditioning Guide** 4.
- Audels **POWER PLANT ENGINEERS GUIDE** 4.
- Audels **PUMPS, HYDRAULICS & AIR COMPRESSORS** 4.
- Audels **WELDERS GUIDE** 1.
- Audels **BLUE PRINT READING** 2.
- Audels **SHEET METAL WORKERS Handy Book** 1.
- Audels **SHEET METAL PATTERN LAYOUTS** 4.
- Audels **AIRCRAFT WORKER** 1.
- Audels **MATHEMATICS and CALCULATIONS** 2.
- Audels **MACHINISTS & TOOLMAKERS Handy Book** 4.
- Audels **MECHANICAL Dictionary** 4.
- Audels **AUTOMOBILE GUIDE** 4.
- Audels **DIESEL ENGINE MANUAL** 2.
- Audels **MARINE ENGINEERS Handy Book** 4.
- Audels **MECHANICAL DRAWING GUIDE** 1.
- Rogers **MECHANICAL DRAWING and DESIGN** 2.
- Audels **MILLWRIGHTS and Mechanics Guide** 4.
- Audels **CARPENTERS and Builders Guides (4 vols.)** 6.
- Audels **PLUMBERS and Steamfitters Guides (4 vols.)** 6.
- Audels **MASONS and Builders Guides (4 vols.)** 6.
- Master **PAINTER and DECORATOR** 2.
- Audels **GARDENERS & GROWERS GUIDES (4 vols.)** 6.
- Audels **ENGINEERS & FIREMANS EXAMINATIONS** 1.
- Audels **ENGINEERS and Mechanics Guides** 12.
- Nos. 1, 2, 3, 4, 5, 6, 7 and 8 complete 12.
- Audels **Answers on Practical ENGINEERING** 1.
- Audels **ELECTRICIANS EXAMINATIONS** 1.
- Audels **WIRING DIAGRAMS** 1.
- Audels **Handy Book of PRACTICAL ELECTRICITY** 4.
- Audels **ELECTRICAL POWER CALCULATIONS** 2.
- Audels **ELECTRONIC DEVICES** 2.
- Audels **ELECTRIC Dictionary** 2.
- Audels **RADIOMANS GUIDE** 4.
- Audels **NEW ELECTRIC LIBRARY at \$1.50 a Volume** 4.
- Vols. I, II, III, IV, V, VI, VII, VIII, IX, X, XI, XII**

Name _____

Address _____

Occupation _____

Employed by _____ PSM

FREE

SEND FOR

ALLIED'S Big 164 Page RADIO CATALOG!

WRITE TODAY!

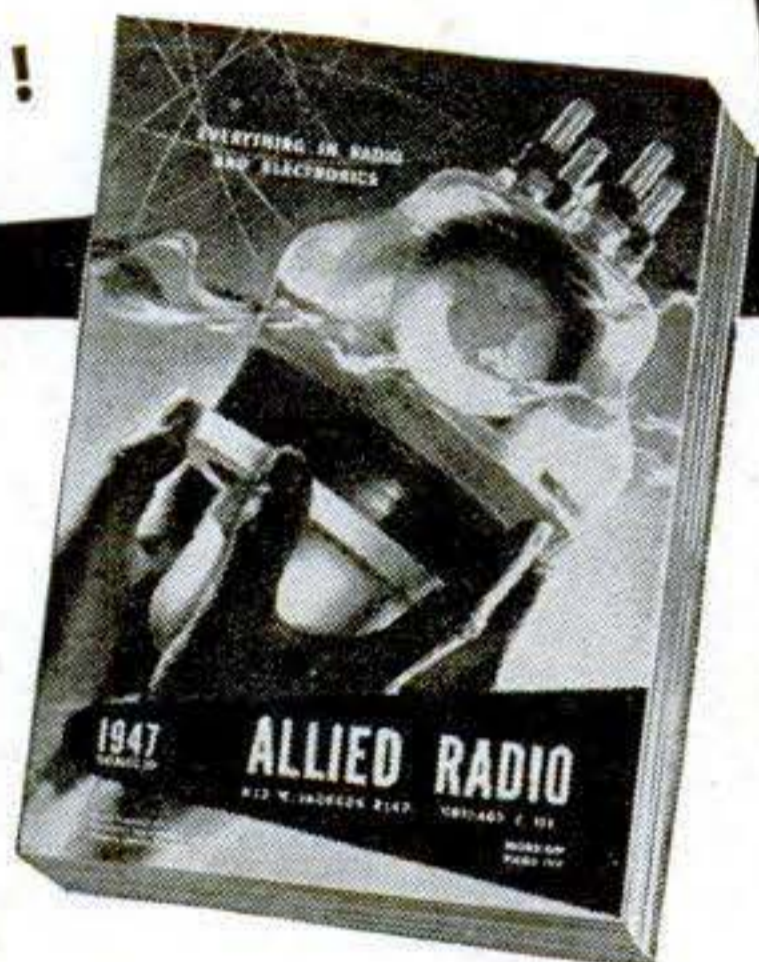

SAVE ON EVERYTHING IN RADIO!

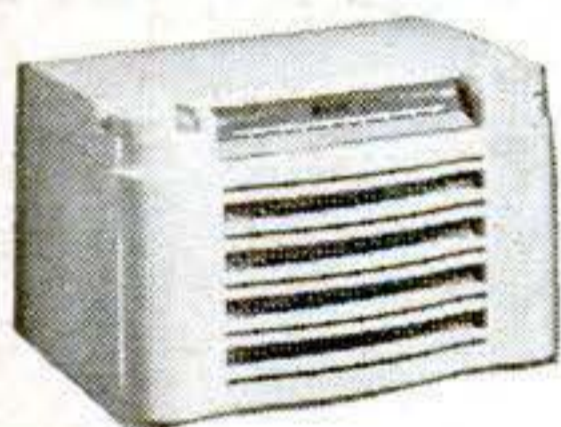

NEW HOME RADIOS



SERVICE SUPPLIES BUILDERS' SUPPLIES



AMATEUR GEAR



SOUND SYSTEMS

164 Value-Packed Pages

Send for your FREE copy of the most complete Buying Guide for Everything in Radio! Here's the Catalog for Servicemen, Dealers, Soundmen, Amateurs, Builders and Experimenters. Features the world's largest and most complete stocks of radio and electronic supplies—quality equipment at lowest prices! Get the speedy service and expert help you want from ALLIED—Radio's Largest Supply House. Depend on ALLIED!

MORE THAN 10,000 ITEMS

Get everything for every radio use: Latest type home radio models, phono-radios, recorders, communications receivers, Ham kits, and gear, code apparatus, radio parts, tubes, tools, test instruments, public address equipment, low-cost easy-to-build radio kits, diagrams and matched parts lists, largest selection of instructive radio books—all at lowest prices!

ALLIED RADIO

ALLIED RADIO CORP.
833 W. Jackson Blvd., Dept. 7-MM-7
Chicago 7, Illinois

Rush FREE 164-Page Catalog

Name.....

Address.....

City.....Zone.....State.....



It Isn't That Easy

Sir:

In reading through your September issue, we found the following figures on page 149: "The 85,000 taximeters in the United States last year ticked off more than \$2,000,000,000." According to our slide rules, this makes about \$23,500 for each taximeter.

If these figures are correct, we should quit school and go buy a couple of cabs. . . .

E. LOUIS LINKY, JR.
M. B. ROUGHTON

Washington, D. C.

While correctly determined, the figures were based on what has since proved to have been an abnormally prosperous year and are therefore not typical. Actually, the average annual take is closer to \$1,000,000,000. Now divide this roughly in half again for your drivers' share. Then there are such items as gas, oil, maintenance, repairs, and insurance. Still want to quit school?

Putting Our Feet In It

Sir:

On Page 250 of the September issue, it is stated that a 370,000-pound milling machine is resting on a 300-cubic-foot concrete foundation. Now me, I am right in the middle of Missouri, b'gosh, and just have to be shown. Can you show me?

J. T. GLAS

Tacoma, Wash.

'Fraid not. The figure should have been 300 cubic yards, not feet. GM gave it in feet, however, and PSM passed it along.

Oops, Wrong Pole

Sir:

If a bar magnet is held against a needle, it will magnetize it, and the needle can then be used to pick up a second needle. But if the first needle is touched by the opposite end of the magnet, it will drop the second needle. Why?

(no signature)

Port Clinton, O.

When the first needle is touched with the bar magnet, its polarity will be reversed. During the brief transition period, the needle will be demagnetized, and thus the second needle will drop.

ADVICE *for the* INVENTOR

The United States Patent Office advises the inventor, unless he is familiar with such matters, to employ a competent, registered patent attorney or agent as the value of patents depends largely upon the skillful preparation of the specification and claims.

PRELIMINARY STEPS *toward* PATENT PROTECTION

The Evidence of Invention form mentioned below is offered as a convenience to the inventor in making his disclosure of invention. The inventor should date and sign his disclosure and have it witnessed by two or more persons who are capable of understanding his invention. The disclosure should then be mailed to the registered patent attorney or agent whom he selects to assist him. The disclosure should be accom-

panied by a letter authorizing the patent attorney or agent to conduct a preliminary search at the U. S. Patent Office among previously granted U. S. Patents for similar types of invention. The patent attorney or agent then prepares a report of the probable patentability of the invention and recommends the further course the inventor should take, provided the report indicates possible patentability.

Victor J. Evans & Company has a staff of experienced registered patent attorneys available to assist inventors in the preparation and prosecution of their cases before the Patent Office.

The **COUPON BELOW** is suggested as a convenience to the inventor in starting action on his invention.

**VICTOR J.
EVANS & Co.**

Merlin M. Evans

REGISTERED PATENT ATTORNEYS

240-P Merlin Building, Washington 6, D. C.

PLEASE SEND DETAILED PATENT INFORMATION TOGETHER WITH CONVENIENT "EVIDENCE OF INVENTION" FORM.

Name.....

Address.....

City and State.....

See the **Amazing Difference** ... the **NEW RADIANT** Screens make in your pictures

Ordinary projection screen surface ... **DULL**, lacking brilliance and contrast

Radiant Glass Beaded Surface... **BRIGHT**, brilliant and contrasty

Your pictures look *twice as bright* when projected on the new 1948 Radiant Projection Screens. They have added brilliance, extra sharpness, more authentic colors. The Special Radiant *glass-beaded* screen surface with millions of tiny glass beads imbedded in pure white plastic—*reflects* light instead of absorbing it. Radiant gives you more new features that make for quicker set-up and easier adjustment. These new Radiant Projection Screens make every picture a better picture!

Send for FREE Screen Guide Today!
 "Secrets of Good Projection," a 32-page booklet, gives proper screen sizes, correct projection lenses, tips for improving projection and many other valuable facts. Mail coupon for your FREE copy.

RADIANT
Reg. U. S. Pat. Off.
 PROJECTION SCREENS

Send me FREE Screen Guide—also latest Circular showing complete line of Portable, Wall, Ceiling and Table Screens.

Name _____
 Address _____
 City _____
 State _____

My Dealer Is _____

Exclusive New Radiant Screen Features

- 1 Self-Opening Tripod Legs*
- 2 Screen Leveller*
- 3 Shakeproof Safety Catch
- 4 Feather Touch Adjusting Handle (U. S. Patent)
- 5 Fully Automatic Auto-Lock*
- 6 Built-In Shock Absorbers*
- 7 Automatic Leg-Lock
- 8 Rubber-Ball Tripod Feet
- 9 Triangular Steel Tube Construction
- 10 Automatic Leg Adjustment
- 11 Finger Grip Carrying Handle
- 12 Streamlined Design
- 13 Automatic Leg Closing
- 14 Complete Range of Screen Heights
- 15 Unconditional Guarantee

The complete Radiant line includes Wall, Ceiling and Table Models in sizes 22 inches x 30 inches to 20 feet x 20 feet and larger

* Pat Pending

20 Million Refrigerators Need Service and Repairs

REFRIGERATION Made Easy!

Biggest Opportunity In Many Years!

NEW PRINTING—ALMOST 1000 PAGES
408 Pictures—17 Diagrams in Colors Makes All Refrigerator Service Maintenance, Repairs Simple as A.B.C.

Millions of refrigerators need service and repairs. Owners are paying big for competent service which will be needed more and more as these refrigerators get older. Get MODERN GAS AND ELECTRIC REFRIGERATION, the non-technical guide to all types of refrigerators and get your share of this new profit. Get a job or start your own service business. This book will help you make money anywhere. Thousands of copies have been sold. Used by trade schools, manufacturers training programs and U. S. Army. Mail coupon. Send \$5.00 or we will send C.O.D. Money back in 5 days if not satisfied. Act now—this may be the opportunity you have been waiting for.

GOODHEART-WILCOX CO.,
 2009 S. Michigan Ave.,
 Dept. 30, Chicago 16, Ill.

Send Gas and Electric Refrigeration. () \$5.00 enclosed. () Send C.O.D. (in U. S. or Possessions). I will return book in 5 days if not satisfactory and you will refund my money. If remittance accompanies order we will pay postage charges.

Name _____
 Address _____
 City _____ State _____

SEND NO MONEY!
 Mail Coupon

WAR SURPLUS BARGAIN SPECIAL

BRAND NEW!
 VACUUM-AIR
 HYDRAULIC
GENERAL PURPOSE PUMP
 Original Cost \$45.00
 Now Only **\$9⁹⁵**

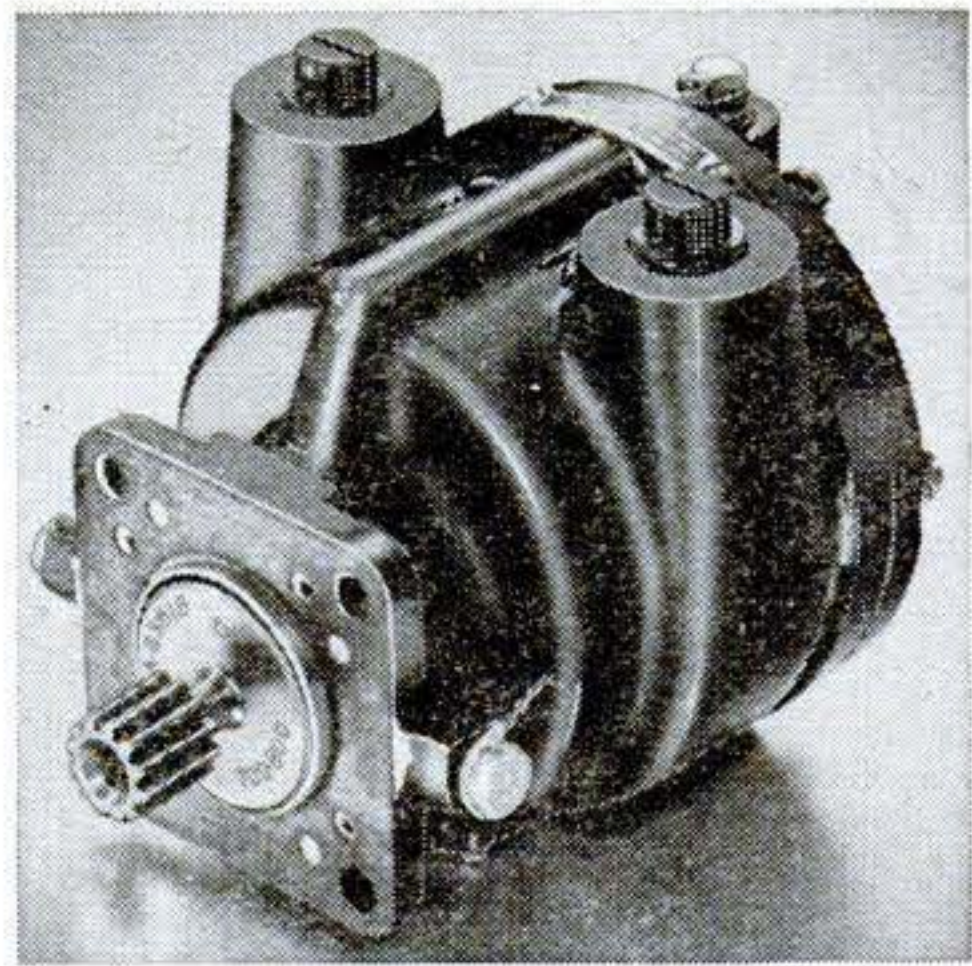

WORTH MANY TIMES THIS LOW SALE PRICE

- USE THEM FOR OIL BURNERS
- SPRAYING MACHINES
- MILKING MACHINES
- COMPRESSORS
- VACUUM PUMPS
- HYDRAULIC SYSTEMS
- MANURE LOADERS
- PRESSES, etc.

Originally cost \$45.00. Used by the Air Corps to drive bomber de-icer boots, gyroscopes, automatic pilots, etc. May be used as air or fluid pump—for pressure or vacuum. Standard 3/8 inch pipe thread with interchangeable ports. Will pump 7 1/2 gal. SAE 30 oil per minute at 300 RPM. Builds air pressure of 30 lbs. per sq. in. at 1000 RPM. Vacuum will draw 26 inches of mercury at 1750 RPM. Develops up to 120 lbs. per sq. inch of hydraulic pressure, which in conjunction with a 3 inch hydraulic cylinder, will lift 840 lbs. minimum. Runs forward or reverse. Self-aligning shaft. Die cast aluminum housing 6x4x4 inches. Has stainless alloy steel vanes and impeller. Made by Bendix Avia, Corp. Spline terminal for direct drive—readily replaced with a pulley. Recommend a 1/4 H.P. or stronger electric motor as source of power. Rated capacity 1500 RPM with high overload factor. Special price for quantity users. Complete illustrated report and instruction booklet FREE with every pump. Send check or money order today. Postpaid in U.S.A.

\$9⁹⁵

GROBAN SUPPLY CO. 1522 So. Michigan Avenue
 Dept. PS12 Chicago 5, Ill.

Now You can Use.



ALL OF THESE RADIO PARTS

to help You learn

RADIO

FASTER-EASIER AT HOME

Or in our Chicago Laboratory

YOU CAN BUILD **133** FASCINATING EXPERIMENTS.

At home—in your spare time—you get real Radio experience from these many *interchangeable* Radio parts and sub-assemblies. Our handy "Block System" eliminates unnecessary mechanical work; the convenient spring clip connections save a great deal of time. You quickly build Radio circuits that work. You experiment with Photo-Electric Cell "Magic" . . . a 5 tube Superheterodyne Receiver . . . a Radio Telephone, and scores of other fascinating projects. Little wonder learning Radio at home is so practical . . . effective and real fun—with this modern "Home Laboratory."

YOU USE "LEARN-BY-SEEING" MOVIES!

Think of the pleasure, as well as help you get from the use of a 16 mm. Motion Picture Projector and exciting "movie" TRAINING FILMS. You will be surprised how much faster . . . easier . . . Home Movies help you understand Radio - Electronic fundamentals. Here's a preferred training method of tomorrow—yours today. SEE the principles of what you're learning—in motion . . . ANIMATED! See circuit actions otherwise hidden from the eye. You get this big Radio home training advantage—exclusively from DeForest's Training, Inc. So act now! Mail coupon for complete details.

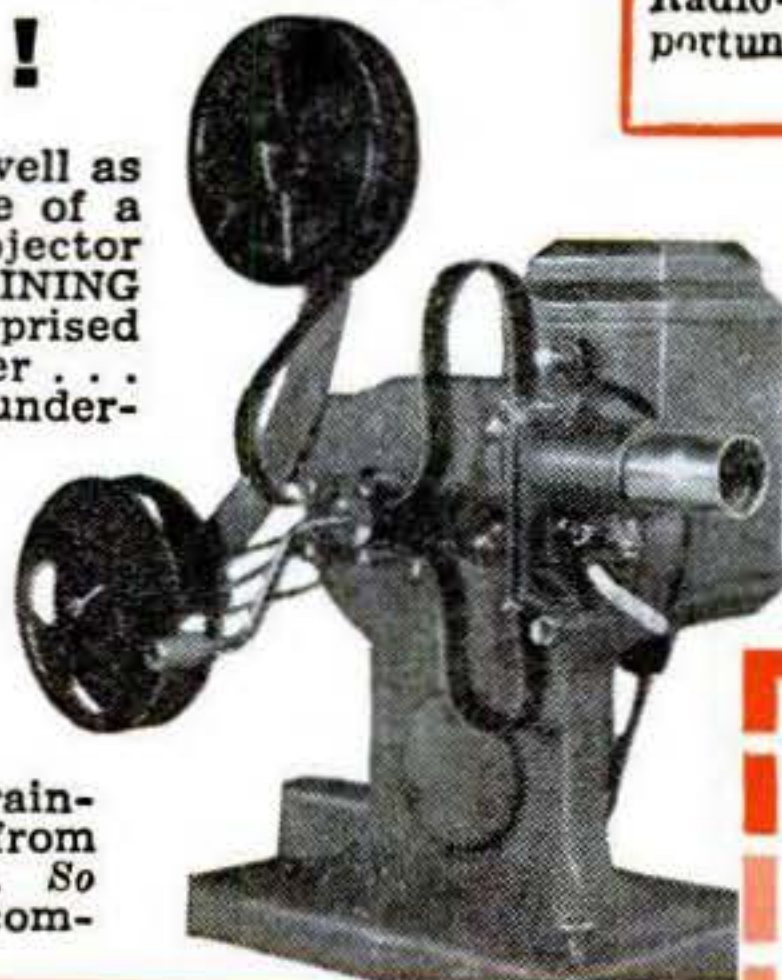

VETERANS!

Big things are happening at DeForest's Training, Inc., for veterans! See how we can prepare you WITHOUT COST for a GOOD JOB or a BUSINESS OF YOUR OWN in the vast Radio-Electronic opportunity field.

See how our fascinating SHOP METHOD Radio Training at home can help you toward a good start in the Billion Dollar Radio-Electronic Field. Write for our BIG FREE book, "VICTORY FOR YOU!" that has helped many to good pay jobs. You'll be surprised at the opportunities ahead in F.M. Radio, Aviation Radio, Broadcast Radio, a Profitable Business of Your Own, Motion Picture Sound Equipment, Electronics—plus the exciting future possibilities ahead of Television, Radar, etc.

You Get "ALL THREE"

Where else can you get such a combination of PROVED MAJOR training features as—(A) modern loose-leaf lessons that are well illustrated with helpful diagrams; (B) the use of "Learn by Seeing" home movie films and a 16mm. MOVIE PROJECTOR—and (C) eight big kits of "Home Laboratory" Radio parts to give you valuable practical Radio experience—at home.

You Also Get EFFECTIVE EMPLOYMENT SERVICE . . . to help you get started toward a Radio-Electronic job or a business of your own. Residential training in our Chicago laboratories also available!

DeForest's Training, Inc., includes instruction in Motion Picture Sound Equipment, FM Radio and Television . . .



DeFOREST'S TRAINING, INC., Dept. PS-D12
2535-41 N. Ashland Ave., Chicago 14, Illinois, U.S.A.

Send—FREE and WITHOUT OBLIGATION—illustrated book, "VICTORY FOR YOU" and KIT SUPPLEMENT, showing how Home Movies and Home Laboratory can speed my preparation for a place in the Radio-Electronics industry.

Name _____ Age _____

Address _____ Apt. _____

City _____ Zone _____ State _____

If under 16, check here for special information.

If a discharged veteran of World War II, check here.

DeFOREST'S TRAINING, INC.

CHICAGO 14, ILLINOIS

AFFILIATED WITH THE DEVRY CORPORATION

Will You Let Me PROVE I Can Make YOU a New Man?

LET ME START SHOWING RESULTS FOR YOU

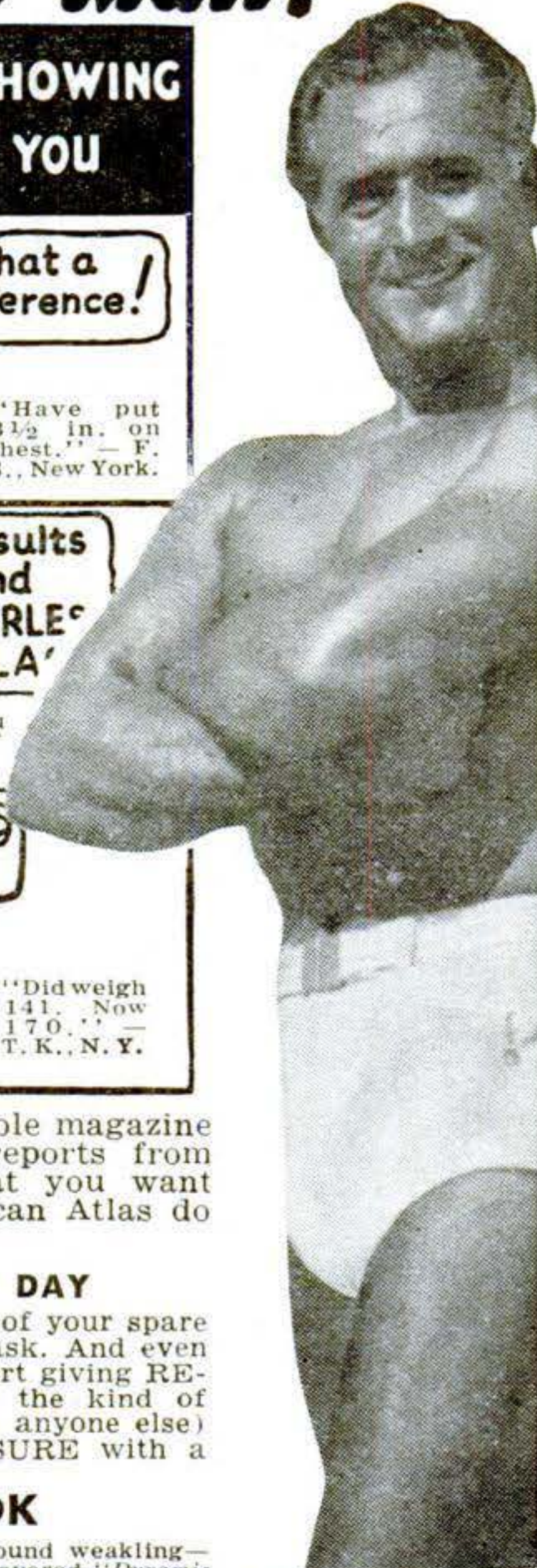
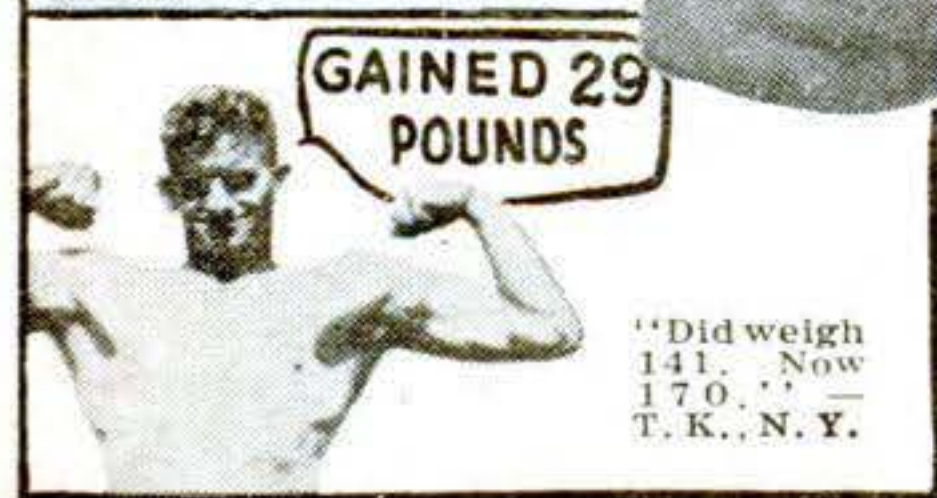
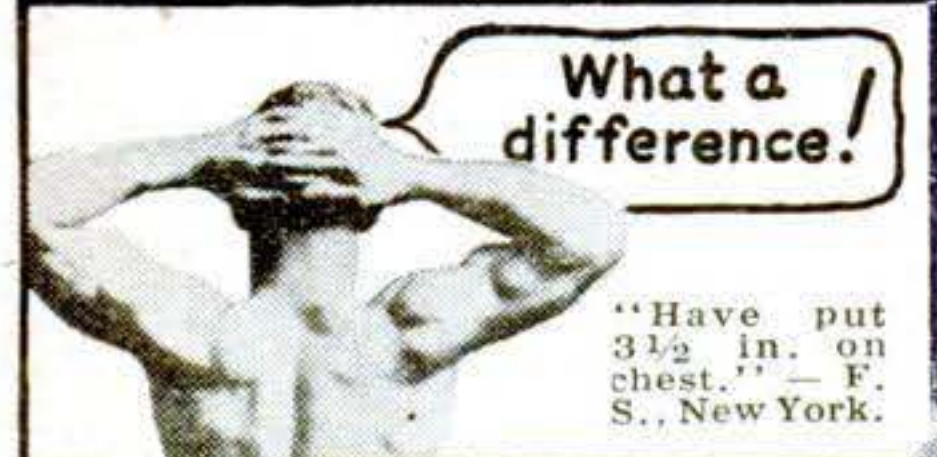

I COULD fill this whole magazine with enthusiastic reports from OTHERS. But what you want to know is — "What can Atlas do for ME?"

15 MINUTES A DAY

Just give me 15 minutes of your spare time daily. That's all I ask. And even in that short time I'll start giving RESULTS. And it will be the kind of RESULTS that you (and anyone else) can SEE, FEEL, MEASURE with a tape.

FREE BOOK

I myself was once a 97-pound weakling—sickly, half-alive. Then I discovered "Dynamic Tension." And I won the title, "The World's Most Perfectly Developed Man!"

"Dynamic Tension" has done so much for other fellows that I simply ask you to let me prove that it can make a New Man of YOU—that it can start new inches of power pushing out your chest—build up your shoulders to champion huskiness—put new, hard, firm muscles on your biceps—make those stomach muscles of yours hard ridges!

Why not risk a postage stamp? Send coupon for my 48-page illustrated FREE BOOK AT ONCE! Address me personally: Charles Atlas, Dept. 112, 115 East 23rd Street, New York 10, N. Y.



**CHARLES ATLAS, Dept. 112,
115 East 23rd Street, New York 10, N. Y.**

I want the proof that your system of "Dynamic Tension" will help make a New Man of me—give me a healthy, husky body and big muscle development. Send me your free book, "Everlasting Health and Strength."

Name _____ Age _____
(Please print or write plainly)

Address _____

City _____ State _____

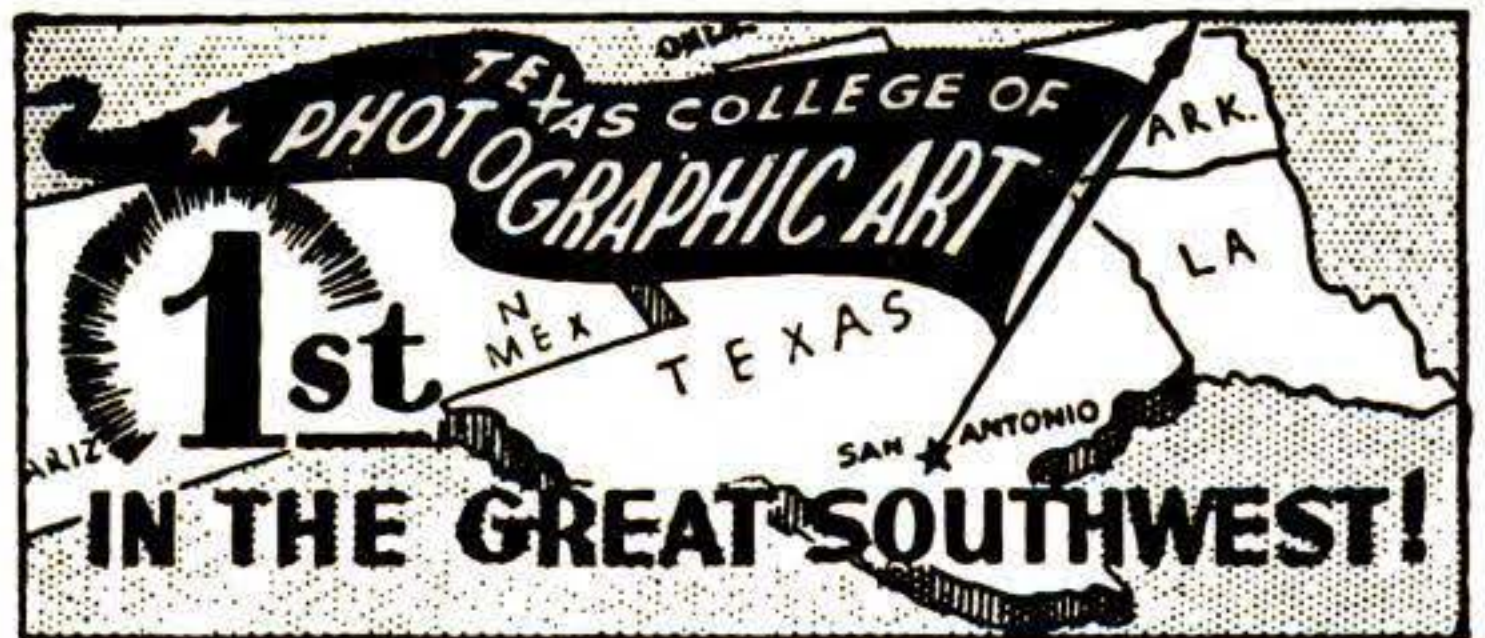

SCENIC and HISTORIC SAN ANTONIO THE PHOTOGRAPHERS' WONDERLAND VETERANS MAY ENROLL UNDER G.I. BILL

LEARN PHOTOGRAPHY NOW

FASCINATING WORK — EXCELLENT PAY
FREE BOOKLET ADDRESS: DEPT 10

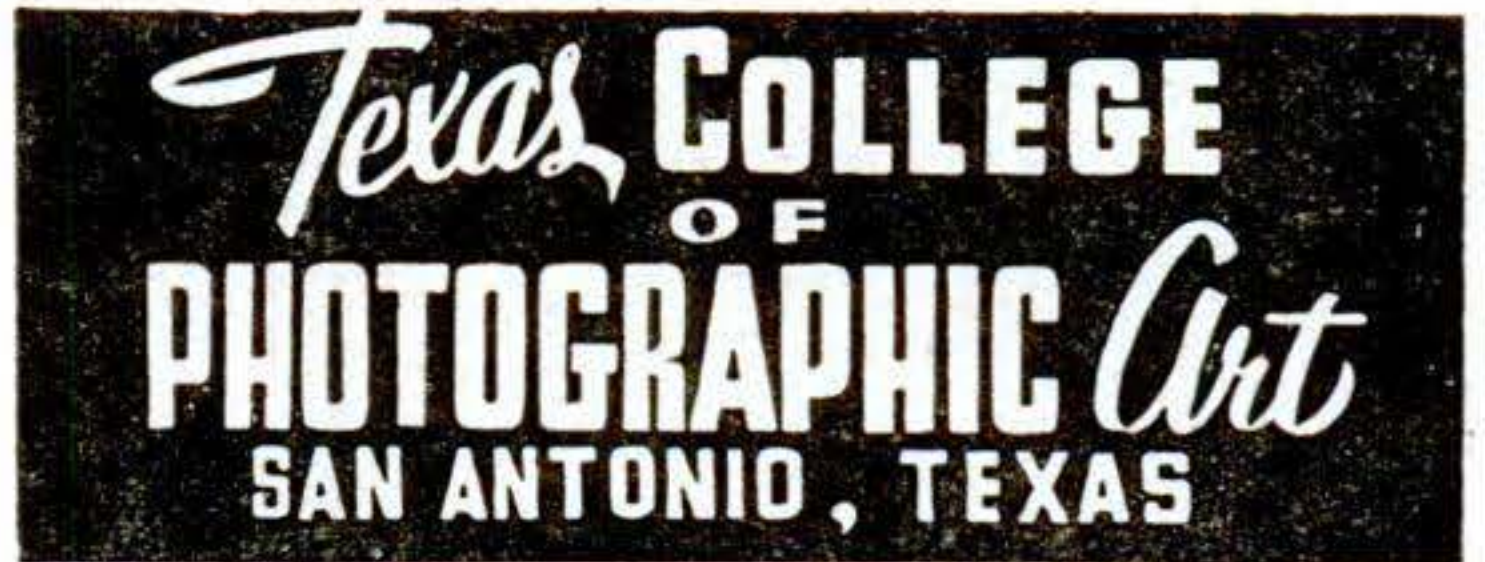

"ONE BLOCK FROM THE ALAMO"

LEARN MONEY-MAKING CARTOONING

IN SPARE TIME — by Easy Picture Chart Method Same Simplified Method that has helped train creators of "Terry & Pirates," "Freckles," "Out Our Way," "Winnie Winkle," "Reg'lar Fellers," "Strange As It Seems," "The Neighbors," and many others. Earn while learning. Send 10c for Picture Chart (to test your ability). Samples of successful students, and full details. (State age.)



The Landon School, 4732 Cleveland Transit Bldg. Cleveland, O.

MAKE MONEY CASTING AT HOME FREE FACTS SENT



Cast thousands of perfect Plaques, Book Ends, Ash Trays, Etc. Plaster, Liquid Marble, Etc. ENORMOUS PROFITS. Start in basement or garage. LITTLE CAPITAL NEEDED. QUICK, EASY. NO PREVIOUS EXPERIENCE NEEDED. Rubber molds for speed production. MAKE YOUR OWN. SAMPLE KIT \$1.00. Canadian \$1.50. PLASTIC ARTS STUDIOS, Route 5, Dept. 45, Muncie, Ind.

PHOTOGRAPHY for PLEASURE or PROFIT

Qualify at Home! Learn expert photography as a joy-full hobby, or to qualify for a well-paid position or your own studio. Previous experience unnecessary with N.Y.I.'s success-proved home study training. Details FREE. Also resident courses.

NEW YORK INSTITUTE OF PHOTOGRAPHY, Dept. 5
10 West 33 St., New York 1, N. Y. (38th Year)

CORRESPONDENCE COURSES IN RADIO and ELECTRICAL ENGINEERING Tuition \$25

ELECTRICAL ENGINEERING. Get good grasp of wide electrical field. Modern. Very understandable. Theory made easy.
RADIO ENGINEERING. Extra fine course in radio, public address, photo-electric work. Trains you to be super-service man, real vacuum tube technician. Tuition ONLY \$25. either course. Deferred payment plan. Servicemen needed badly.

FREE Write for free copies of school catalogs, student magazines, etc.
LINCOLN ENGINEERING SCHOOL, Box 931-S-108
LINCOLN, NEBR.

Easy Self-Instruction In All 25 Branches Of MATHEMATICS

Brought To You By Experts From Leading Colleges
In the 4 volumes of the PRACTICAL MATHEMATICS LIBRARY. Helps you qualify for the better jobs in industry. 1300 pages, 600 illustrations. Sent for free examination. Only \$2.00 down. \$2.00 a month; total \$9.80 plus postage. (Cash price \$9.50. postage free. Money-back guarantee.) 160-page 6-Place Logarithm book free with order. National Educational Alliance, Inc., Dept. 8012, 37 West 47th St., New York 19, N. Y.

**WE BRING
NATIONAL SCHOOLS
TO YOU FOR
HOME TRAINING IN
RADIO
TELEVISION &
ELECTRONICS**

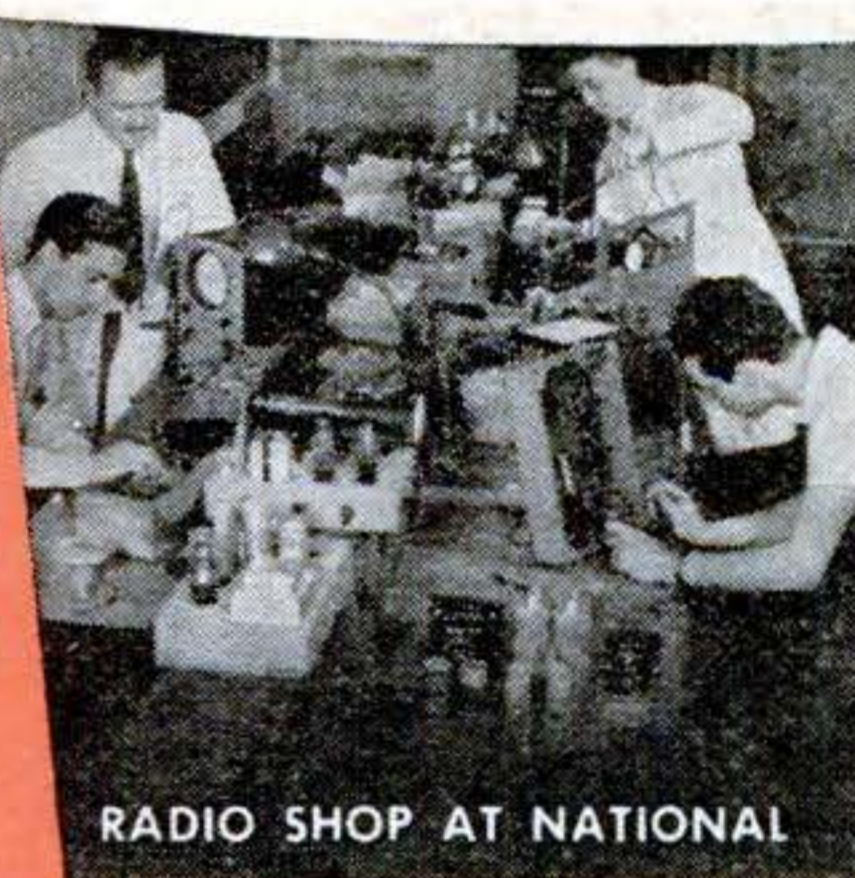

RADIO SHOP AT NATIONAL



BROADCAST STUDIO AT NATIONAL

Partial View of the
Facilities that Stand
Behind Your National
Schools Home Training



Since 1905



TELEVISION STUDIO AT NATIONAL

For over 42 years one of
America's Leading Trade Schools

**NATIONAL SCHOOLS SHOP METHOD HOME TRAINING
WILL START YOU RIGHT**

We will train you today to get started tomorrow in one of the thousands of opportunities opening in the field of Radio, Television and Electronics. The fields of Home Radio Service . . . Television sales and service . . . Electronics . . . Radar . . . Radio aboard ships and airplanes . . . Frequency Modulation in Broadcasting . . . all are becoming more important. The list of Radio applications is endless, and every one represents increasing opportunities in our modern world for the *Radio, Television, and Electronics Technician with a Solid Technical Background.*

YOU CAN BE A NATIONAL SCHOOLS MAN

It is not a question of opportunity but rather how to take advantage of existing opportunity. Only proper training can make these opportunities a *reality*. National Schools of Los Angeles, one of the oldest and largest technical trade schools in the United States, offers you *Shop Method Home Training, a proved method that builds qualified technicians.* Here is Home Training that BRINGS RESULTS. Behind all training from National Schools stands a permanent faculty of experienced instructors and engineers. These men are daily teaching resident students right in our own

Shops and Laboratories. From first hand experience with students here at school, our instructors understand the needs and ambitions of men like you. All of our instructors, both Home Study and Resident, have ideal facilities to make your training practical, up-to-the-minute, interesting. It takes years of experience to know how to train men, especially in the practical technical trades. Established almost 50 years ago, National Schools has a rich background of experience to help you to take full advantage of the opportunities in the Radio, Television and Electronics Industry.

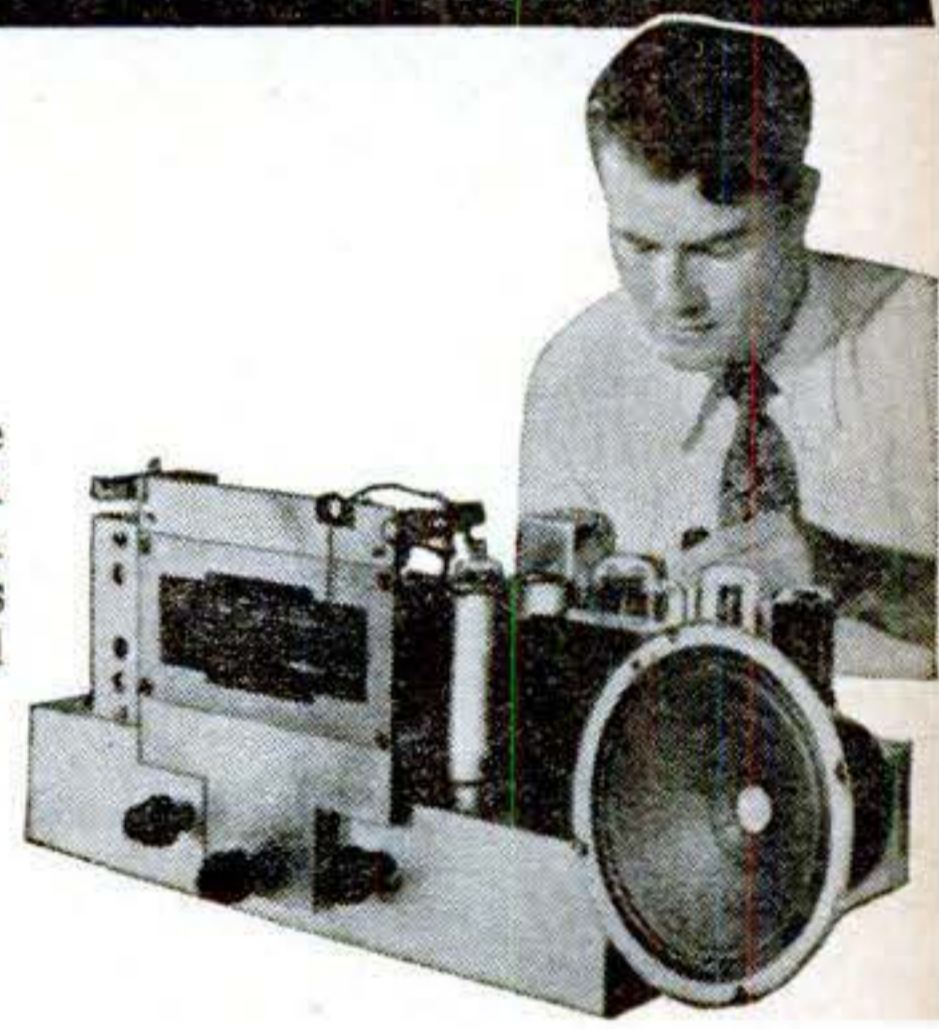

**YOU GET ALL THIS RADIO
EXPERIMENTAL EQUIPMENT
TO USE AND KEEP AT HOME**

Learn by Doing is the basic principle of National's Shop Method Home Training. We send you standard Radio parts for an interesting series of experiments, which demonstrate the fundamentals of Radio, Television and Electronics. You build many different types of circuits, a fine, long distance **Modern Superheterodyne Receiver**, signal generator, low-power Radio transmitter, audio oscillator, etc. This **practical work** develops your knowledge of Radio step-by-step, makes you a **practical Radio technician.**

G. I. APPROVED

NATIONAL SCHOOLS

LOS ANGELES 37, CALIFORNIA EST. 1905

MAIL OPPORTUNITY COUPON FOR QUICK ACTION

National Schools, Dept. 12-PS
4000 South Figueroa Street
Los Angeles 37, California

(Mail in envelope
or paste on penny
postcard.)

Mail me FREE the books mentioned in your ad including a sample lesson of your course. I understand no salesman will call on me.

NAME..... AGE.....

ADDRESS.....

CITY..... ZONE..... STATE.....

Check here if veteran of World War II



VETERANS

During the war, National trained enlisted men under contract with the War Department. Both the Armed Forces Institute and Marine Corps Institute used our lesson texts on a wide scale. Now, we are training veterans, both resident and home study, through the Veterans Administration. If you are a veteran of World War II—and qualified for training under the G. I. Bill of Rights, check the coupon for special information.



**GET
THESE
2
BIG BOOKS FREE!**

WANT A KEY JOB OR A BUSINESS OF YOUR OWN?

BIG OPPORTUNITY

REFRIGERATION—AIR CONDITIONING

Take a good look at the man you envy. What has he got that you haven't got? The chances are his success is simply a matter of training. He knows his job. He is a specialist in his field.

Why, then, should you be content with a small job at small pay. The door to opportunity is open today—wider than ever before. Now is the time to do something about your future.

Take a friendly tip. Investigate the field of Refrigeration & Air Conditioning. Here is an industry that offers every opportunity you could ask . . . good jobs, security—plenty of chance for advancement—a business of your own.

The Industrial Training Institute, largest and most completely equipped school of its kind in the world, will give you the practical training you need. You can start at home without giving up your present job and when you have completed your theoretical training, we will bring you to Chicago where you will learn the practical "know-how" by working on actual equipment in our big, expertly staffed shops.

No advanced schooling is needed. Our unique proved methods make everything easy to grasp. We've trained thousands. Pay as you go. Quit when you want to. But in any case our first responsibility is to prepare you for a better job and a happier future. And after you have graduated you enjoy all the advantages of our life-time employment service—wherever you go, whenever you need it.

FACTS ABOUT THE INSTITUTE

Founded in 1916. Has trained more than 400,000 men for practical work in industrial fields. From 1942 through 1945 trained specialized technicians, exclusively, for the Army, Navy and Marine Corps. Now training thousands of veterans under the G.I. Bill, both in its Residence Schools and by home-study. Occupies five buildings of its own. Has over \$500,000 invested in training facilities, with an instruction staff of more than 100 men. Known everywhere as America's foremost school of practical training for industry.

ACT NOW

Don't delay. Time is passing fast. Mark and mail the coupon below. It will bring you, without obligation, full details of this and other courses, from which you may choose. Take the step that may be the turning point in your career to a better job and bigger earnings.

SEND FOR THIS BOOK —IT'S FREE



Industrial Training Institute,
50 Lawrence Ave., Dept. P2MR Chicago 25, Ill.

I am interested in getting ahead. Send me FREE copy of your "Camera Visit" book. I would like to train

_____(name field).

Name _____

Address _____

City _____

Are you a Veteran _____

GET THE FACTS ABOUT AMERICA'S FOREMOST SCHOOL OF PRACTICAL TRAINING



WAKE UP YOUR SCALP Want better looking hair? Embarrassed by falling dandruff, itching scalp? Then try VITABRUSH, new electric driven scalp brush that gives your scalp a vigorous and invigorating "workout" in just three minutes of fun. Cleans scalp. Stimulates blood supply. Restful. Pleasant. Write today for complete information and satisfaction-guaranteed offer. Hershey Mfg. Co., 3718 Field Bldg., Chicago 3

3 In 1 AIR PISTOL

SPORTSMAN JR.—Sensational, low-priced air pistol. Ruggedly built, full size target gun shoots either standard BBs, pellets or steel darts. Fast, single-action compression chamber. Single shot, silent shooting. Use indoors or outdoors. Modeled after famous target pistol. Economical to operate. Die cast all metal non-slip moulded grip; machined steel chamber and barrel. 8-in. long; 4 1/2-in. deep; full size, weighs 15 oz. **EACH \$3.49**

BBs, 3 pkgs. 25c; .177 pellets, 500 for \$1.50; steel darts, 35c package. Order Plenty of Ammunition.

JOHNSON SMITH & COMPANY, Dept. B-71, Detroit 7, Michigan

GIANT Astronomical Telescope

100 diameters magnification. (10,000 area magnification) 3 inch diameter steel main tube 50 inches long. Brass focusing tube. Tripod 6 feet high. Equatorial mounting. Ready to set up and use. Full power and clear vision guaranteed. Price \$15.00. 20% deposit on C.O.D. orders. **DEPT. BT, SUFFOLK SCIENCE SERVICE, MANORVILLE, N. Y.** "NO EXPORT ORDERS ACCEPTED"

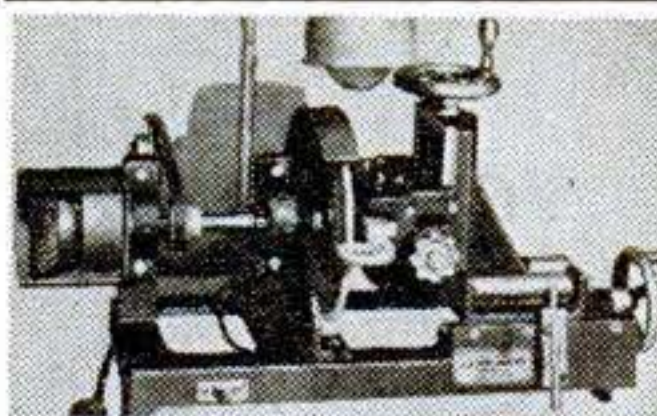

Start a NEW BUSINESS Sharpen Dull Pipe Wrenches

Or Add to Your Present Repair Business

Write for information.

J. C. MOORE INDUSTRIES P.O. Drawer 276 FREDONIA, PA.

DETECTIVES

Home Study in Detective Training—Professionally Modernized—Recognized Instructors—Easy Payments—Write **INTERNATIONAL DETECTIVE TRAINING SCHOOL** 1701-P Monroe St. N. E. Washington 18, D. C.

Photography for



PLEASURE or PROFIT

Learn at home. Spare time. Practical basic training. Long-established school. Many have earned while learning. Send coupon below for free booklet, "Opportunities in Modern Photography" and full particulars.

AMERICAN SCHOOL OF PHOTOGRAPHY
1315 Michigan Avenue Dept. 1369 Chicago 5, Illinois

Send booklet, "Opportunities in Modern Photography," full particulars and requirements. No salesman will call.

Name _____

Address _____

City _____ Zone _____ State _____

Learn RADIO

in a Few Weeks

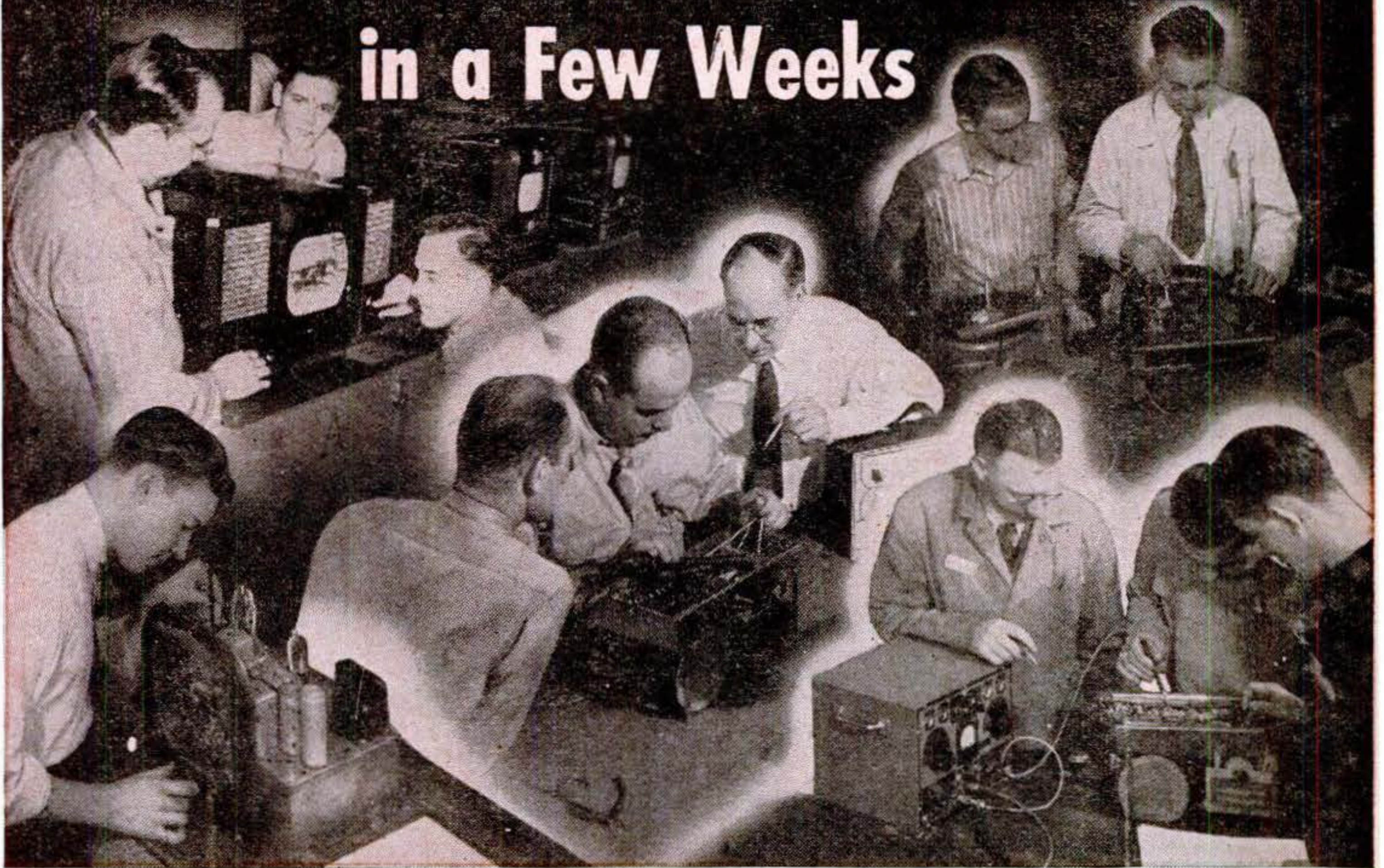

In the GREAT SHOPS of COYNE

NOT A "HOME-STUDY" COURSE!



B. W. Cooke

Men, here's the quick, easy way to learn Radio—with practical training in the Great Shops of COYNE. All training given on full-size equipment under friendly, helpful instructors, plus necessary theory. We do not teach by mail. At Coyne you learn Radio Set-building and Trouble-shooting, Public Address and Sound Systems, Television, Electronics, how to start your own shop. Prepare NOW for better jobs, bigger pay. Mail coupon today!

ATTENTION, NON-VETERANS!

Don't let lack of money hold you back. Our Student Finance Plan has helped thousands. Pay most of tuition after you graduate. We also help you get part-time work while here, if you wish. Lifetime Job Service FREE to Coyne-trained men.

INCLUDED!

Added training in Electric Refrigeration Now Included with Radio Course.



VETERANS!

COYNE is authorized to train men who qualify under the G. I. Bill. Coupon brings special G. I. Bulletin.

SEND NOW FOR BIG FREE BOOK

Dozens of actual photos taken in the Great Shops of Coyne—also vital facts about YOUR opportunities in Radio-Electronics and Television. Coyne gives you ALL-AROUND Training, to prepare for many branches of the vast Radio field. Send for this book today. No obligation, and no salesman will call on you. Rush the coupon—new class starting soon!



Founded 1899

B. W. COOKE, President, Radio Division

COYNE ELECTRICAL SCHOOL
500 S. PAULINA ST. Dept. 97-4H CHICAGO 12

FREE BOOK COUPON

B. W. COOKE, President
COYNE ELECTRICAL SCHOOL, Radio Division
500 S. Paulina St., Dept. 97-4H, Chicago 12, Ill.

I want to build a REAL FUTURE for myself. Send your big FREE BOOK on RADIO, also details of Student Finance Plan and Lifetime Employment Service. This does not obligate me in any way, and no salesman will call.

NAME.....
ADDRESS.....
CITY..... STATE.....

...MAIL THIS TODAY!

Increasing your hold on your job and giving yourself a chance for advancement

Few men deliberately plan to work persistently on self-improvement. If progress comes naturally, they're happy; if it doesn't, they worry or ignore the situation. Yet it is possible to pay attention to self-improvement with considerable hope of success. A noticeable degree of advancement is practically assured any one who will make an intelligent and persistent effort. Thousands of men have proved this for themselves with:



The Croft Library of Practical Electricity

The Croft Library is a complete electrical educator. It is founded on practice—on 20 years of shirt-sleeve experience—on work as it is actually done. It is jammed from cover to cover with the kind of hard-headed facts you want. Written so that the beginner can easily understand it, yet so sound, so thorough, that it is the daily guide of 59,000 highly paid electrical workers and engineers. Croft tells you the things you need to know about motors, generators, armatures, commutators, transformers, circuits, switchboards, distribution systems—electrical machinery of every type—wiring for light and power—wiring of finished buildings—underwriters and municipal requirements—illumination in its every phase—the most improved methods of lighting lamps—and lamp effects, etc.—how to do a complete job, from planning it, to completion.

No money down—easy payments

Fill in and mail the coupon attached and we will send you the entire set of seven volumes for ten days' examination on approval. We take all the risk—you assume no obligation. If you decide to keep the books, send \$3.50 in ten days and the balance at the rate of \$4.00 a month. Send the coupon NOW and see the books for yourself.

McGraw-Hill Book Co., 330 W. 42nd St., New York 18, N. Y.
 Send me for ten days' examination on approval the Croft Library of Practical Electricity, 7 vols. If satisfactory I will send you \$3.50 in 10 days and \$4.00 monthly until the price of \$19.50 is paid. If not wanted, I will return the books postpaid. (To insure prompt shipment write plainly and fill in all lines.)

Name.....
 Home Address.....
 City and State.....
 Company.....
 Position..... PSM-12-47

NOW! Build Your Future On DIESEL Opportunities

LOOK around you. See the way tractors, trucks, buses, railroads, ships, power plants and equipment of many kinds are "going Diesel." Every day new opportunities are opening—in industrial and farming communities—for trained men who can install, maintain, operate and repair Diesel engines. Plan now to build your future in this growing field.

Diesel Knowledge is Earning Power

You don't have to give up your present job. Now, you can begin learning DIESEL in spare time at home. UEI practical training teaches you, step by step, how Diesel engines operate, how fuel systems work, repairs, accessories and auxiliary equipment; a world of Diesel "know how." Includes actual practice on Diesel equipment in our shop under expert guidance. UEI training methods are successful. For 20 years they have helped mechanically inclined men better themselves.

NOW IT'S UP TO YOU!

Coupon below brings you all the facts without cost or obligation. Get going today! MAIL COUPON NOW.

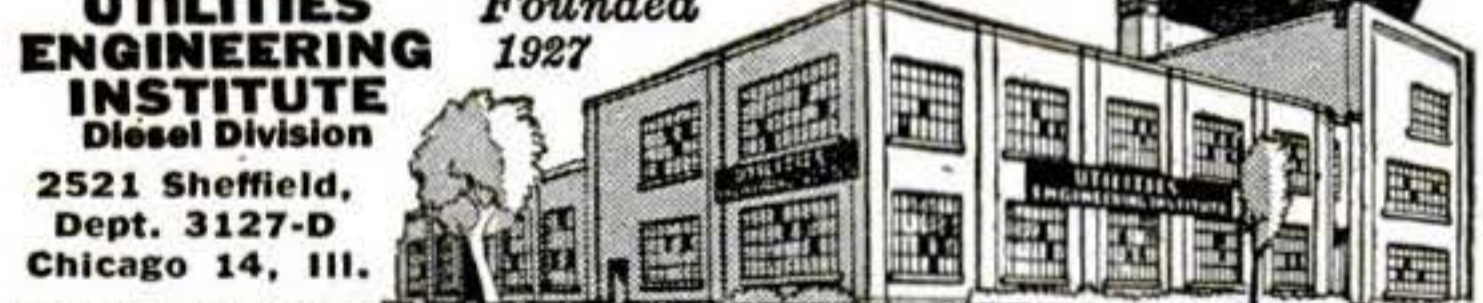

UTILITIES ENGINEERING INSTITUTE, Diesel Division
 2521 Sheffield, Dept. 3127-D, Chicago 14, Ill.

Please send me Free Facts about Diesel opportunities and training.

NAME..... Age.....
 ADDRESS.....
 CITY..... Zone or County..... STATE.....

Check here for special information if you are under 17.
 Check here if Veteran of World War II.

STUDY AT HOME

With An Educational Institution

Men with specialized training win higher positions, insure larger earnings, and are bigger successes in business and public life. Opportunities NOW greater than ever before. Send for our Catalog.

ARTS and SCIENCES

Courses in Philosophy; Education; Letters; Public Health; Medical Jurisprudence; Psychology; Sociology; Physics; Chemistry; Plastics; Geology; Political Science; Theology; Business and Commerce; Accounting; Mathematics; Statistics; Agriculture.

ENGINEERING

Courses in Electrical, Civil, Mechanical, Drafting, Architectural, Steam, Aeronautical, Radio, Structural, Mining, Industrial, Petroleum, Marine, Chemical, Diesel, Automobile, Refrigeration, and Air Conditioning Engineering.

LAW

Complete Professional Law Course includes 18 Hornbrook Series college grade textbooks. Courses also in Commercial Law, Patent Law and Medical Jurisprudence. McKinley-Roosevelt Incorporated, 4610-AB, Sheridan Rd., Chicago 40, Ill.

SHORTHAND in 6 Weeks at Home

Famous Speedwriting system. No signs or symbols; uses ABC's. Easy to learn; easy to write and transcribe. Fast preparation for a job. Surprisingly low cost. 100,000 taught by mail. Used in leading offices and Civil Service. Write for free booklet. Speedwriting, Dept. 2612-7, 55 W. 42 St., N. Y. 18, N. Y.

Learn LANDSCAPE GARDENING

A thorough, interesting constructive home training, covering your regional conditions, for those who wish to become LANDSCAPERS, DESIGNERS, GARDENERS, etc., for profit or pleasure. Write today for FREE INFORMATION without obligation.

Approved for Veterans—in all States
 NATIONAL LANDSCAPE INSTITUTE

Dept PS-12, 310 So. Robertson, Los Angeles 36, Cal.

ANALYZE HANDWRITING Illustrated Lesson FREE and Grapho Analyst

shows you how to make money at home, full or spare time. Opportunities everywhere. FREE Analysis Offer for immediate answer. Must be over 21. A.I.G.A. Inc., Wilhoit Bldg., Dept. 126-M, Springfield, Mo.

RADIO ENGINEERING

Television, FM, Broadcasting, Servicing, Electronics, Aviation, Marine & Police Radio taught thoroughly. 72 weeks' Engineering course equivalent to 3 years' college radio work. Approved Veteran Training. Catalog upon request. Valparaiso Technical Institute, Dept. 503, Valparaiso, Ind.

If Ruptured



Do What Others Now Do—
 Wear a Form Fitting
MILLER Truss

which provides natural freedom and comfort in working, walking, playing, horse back riding, dancing, swimming or sleeping. You just cannot afford to be without this protection and convenience.

Wear two weeks then consult your physician before deciding to keep it.

Write me today for FREE descriptive circular. Sent in plain, sealed envelope.
FRED B. MILLER Manufacturer
 Dept. P.S. Hagerstown, Maryland.

Now YOU Can Lick Any AUTO REPAIR JOB!

IN LESS TIME—WITH LESS WORK



**FREE
7-DAY OFFER**



MoToR's New AUTO REPAIR MANUAL
shows you how to service and
repair ANY part of ANY car!

No auto repair job is too tough when you've got MoToR's AUTO REPAIR MANUAL! YOU can repair anything from carburetor to rear end—quickly, easily, right! Just look up make, model, and the job in the quick index—and go to work! Clear, illustrated instructions lead you step by step.

To make such an amazing book possible, the engineer-editors of MoToR Magazine collected and "broke down" 150 official factory shop manuals for you, spotted all the vital repair information you need, dove-tailed it all together into ONE handy, easy-to-understand book.

No Other Manual Like It!

This BIG book—856 pages, 8½x11 inches, bound in sturdy fabric—brings you nearly 200,000 service, repair, adjustment, replacement, tune-up facts on every car built from 1935 through 1946. More than 1000 cut-away photos, diagrams,

drawings show you exactly WHAT to do and HOW to do it! Used by the U. S. Army, trade and technical schools everywhere, thousands of auto servicemen.

Now YOU—without cost—can see for yourself what a wonderbook MoToR's Auto Repair Manual really is. TRY it—FREE for 7 days! Learn first-hand how it can pay for itself the first few times you use it.

SEND NO MONEY 7-Day Free Examination

Just mail coupon below—without money! When the postman brings your book, pay him nothing. First make it show you what it's got! Unless you agree this is the greatest time-saver and work-saver you've ever seen—return book in 7 days and pay nothing. Mail coupon today! Address: MoToR Book Department, Desk 2P, 572 Madison Ave., New York 22, New York.

USED BY
U. S.
ARMY

Clear, Pictured Facts on Every Job on Every Car Built Since 1935!

Nearly 200,000 service and repair facts on all these makes:

American	Dodge	Nash
Bantam	Ford	Oldsmobile
Auburn	Graham	Overland
Austin	Hudson	Packard
Buick	Hupmobile	Pierce Arrow
Cadillac	Lafayette	Plymouth
Chevrolet	La Salle	Pontiac
Chrysler	Lincoln	Reo
Cord	Lincoln	Studebaker
Crosley	Zephyr	Terraplane
De Soto	Mercury	Willys

856 big pages; including 50 pages of carburetor text, charts, illustrations, covering all models. Over 500 charts, tables; Tune-up Chart; Valve Measurements; Compression Pressure; Torque Wrench Reading; Starting Motor; Engine Clearances; Generator Clutch & Brake Specifications; Front End Measurements, etc. Engines; Electric, Fuel, Cooling, Lubricating Systems; Transmissions; Universals; Front Ends; Wheels; Rear Ends, etc.

Same FREE 7-Day Offer Applies on MoToR's TRUCK REPAIR MANUAL

For mechanics, truck specialists, service stations, fleet owners. Covers EVERY job on EVERY truck made since 1936! 1400 pictures, 952 pages, 300,000 facts. Used by Armed Forces. Warranted to contain every essential fact you need to know. Sturdy binding, size 8½ x 11.

Covers all types Gasoline Engines; Diesels and Hessel-

mans. Fuel Systems, Governors. Lubrication Systems, Ignition Systems, Starters, Generators, Clutches, Transmissions, Axles, Torque Dividers, Transfer Cases, Brakes, Steering, etc., etc.

ALSO SERVICES buses, farm and industrial tractors, contractor and road building equipment, stationary power machinery, etc. (on all parts described in Manual).

Offered on same FREE 7-day examination as Auto Repair Manual. Check box in coupon at right.



MoToR Published by MoToR, The Leading Automotive Business Magazine. MoToR's manuals assure high standards of repair work.

MAIL COUPON NOW FOR 7-DAY FREE TRIAL

MoToR Book Dept., Desk 2P, 572 Madison Ave., New York 22, N. Y. Rush to me at once: (check box opposite book you want).

- MoToR's AUTO REPAIR MANUAL. If O.K. I will remit \$1 in 7 days, (plus 35c delivery charge), then \$2 monthly for 2 months, and a final payment of 95c one month later. (Book's price \$5.95.) Otherwise I will return book postpaid in 7 days. (Foreign price, remit \$8 cash with order).
- MoToR's TRUCK REPAIR MANUAL. (Described at left.) If O.K., I will remit \$2 in 7 days, and \$2 monthly for 3 months, plus 35c delivery charge with final payment (\$8.35 in all). Otherwise I will return book postpaid in 7 days. (Foreign price, remit \$10 cash with order).

Print Name.....Age.....

Print Address.....

City.....Zone No. (if any).....

State.....Occupation.....

SAVE 35c! Check here if enclosing full payment (Check M. O. or Postal Note) WITH coupon. We pay 35c shipping costs. Same 7-day return-refund privilege.

Keep that "TICKING" Car

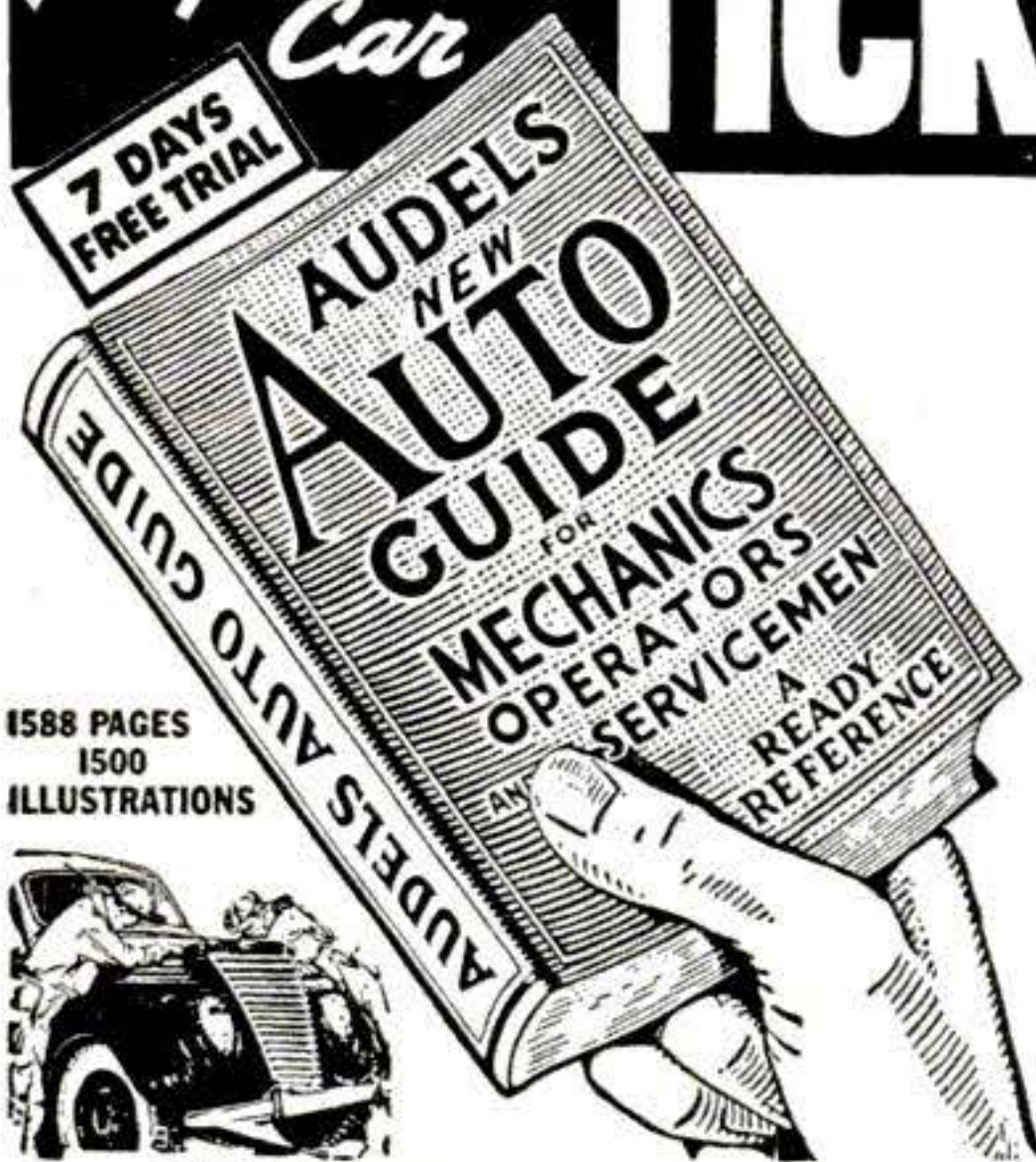

Every operator and mechanic needs AUDELS AUTO GUIDE.

This book saves time, money and worry. Highly endorsed. It presents the whole subject of auto mechanics:

- 1—Basic principles
 - 2—Construction
 - 3—Operation
 - 4—Service
 - 5—Repair
- Handy Size. Easily understood.

NEW FLUID DRIVE, HYDRAULIC SHIFT AND DIESEL ENGINES FULLY COVERED

Over 1500 pages—1540 illustrations showing inside views of modern cars, trucks and buses with instructions for all service jobs.

\$4 COMPLETE • PAY ONLY \$1. A MONTH ←

ASK TO SEE IT!—To Get This Assistance for Yourself Simply Fill in and Mail Coupon Today.

AUDEL Publishers, 49 West 23rd St., New York

MAIL AUDELS NEW AUTO GUIDE for free examination. If O.K. I will send you \$1 in 7 days; then remit \$1 monthly until price of \$4 is paid. Otherwise I will return it.

Name.....
 Address.....
 Occupation.....
 Employed by..... P.S.M.

Can a Man MY Age Become a HOTEL EXECUTIVE

Even Though He Has No Previous Hotel Experience?

Would you like to step into a well-paid position as Hotel or Club Manager, Purchasing Agent, Social Director, Restaurant or Inn Manager, Assistant Manager? Would you like to be able to look forward happily to the future? The success of Lewis graduates from 18 to 50 PROVES you can—though you never had a minute's experience in hotel work.



Becomes Hotel Steward Although He knew Nothing About Hotel Business

"Shortly after receiving my diploma from the Lewis Hotel Training School, I gave up my job in a power plant and accepted a position obtained for me by the Lewis Placement Bureau as Assistant to the Manager of a famous country club. Now Steward of this 350 room hotel. Have been here eleven months and have had three raises in salary," writes C. P. Hearne.

Step Into a Well-Paid Hotel Position FREE Book Gives Fascinating Facts

Our FREE Book, "Your Big Opportunity," explains how you can qualify for a well-paid position at home, in leisure time; tells how you are registered FREE of extra cost in the Lewis National Placement Service; shows how you can be a Lewis Certified Employee—certified to "make good" when placed in a position. Mail the coupon NOW!

Course approved for Veterans' Training

Lewis Hotel Training School
 Room LX-2724, Washington 7, D. C.

32nd SUCCESSFUL YEAR

Send me the Free Book, "Your Big Opportunity," without obligation. I wish to know how to qualify for a well-paid position at home, in my leisure time.

Name.....

Address.....

City.....Zone.....State.....

Check here if eligible under G.I. Bill of Rights.

LEARN IN THE GREAT ALLIED SHOPS

— Est. 1928 —

Practical Courses in:

- TOOL & DIE MAKING:** Instruction in making tools, dies, jigs, fixtures, etc. Layout and assembly work, heat treating, etc.
- MACHINIST TRADE:** Shop training in setup and operation of all-around machine work, layout and assembly.
- TOOL & DIE DESIGNING:** Comprehensive instruction in designing of tools and dies, jigs and fixtures, special machines, special devices, etc.
- MECHANICAL DRAFTING:** Practical training in all phases of technical and mechanical drafting, machine drawing, and sheet metal drafting.
- TOOL ENGINEERING:** Detailed study of Engineering Materials, Manufacturing Processes, Pattern Design, Inspection Methods, Production Planning, Welding Methods, Screw Machine Engineering, etc.

Learn under the Supervision of an Accredited Staff.

Day & Evening Classes

Approved for Veterans

Send for FREE Illustrated Bulletin.

4412 Allied Bldg.

1338 S. Michigan Ave.,

Chicago 5, Ill.

ALLIED SCHOOL OF MECHANICAL TRADES

LAW...

STUDY AT HOME Legally trained men win higher positions and bigger success in business and public life. Greater opportunities now than ever before.

More Ability: More Prestige: More Money We guide you step by step. You can train at home during spare time. Degree of LL.B. We furnish all text material, including 14-volume Law Library. Low cost, easy terms. Get our valuable 48-page "Law Training for Leadership" and "Evidence" books FREE. Send NOW, LASALLE EXTENSION UNIVERSITY, 417 South Dearborn Street A Correspondence Institution Dept 1283-L Chicago 5, Ill.

BE A NAVIGATOR OF SHIPS • OF PLANES

Train at home, in spare time for a fascinating, good pay job in marine or air navigation. Weems Course enables you to meet CAA requirements for commercial airline navigators—and navigation requirements for Master's or Mate's license in Merchant Marine. Many Weems graduates now officers in Navy, Coast Guard, Army-Navy Air Forces and Commercial Airlines. Write today for free descriptive catalog. G. I. Plan. WEEMS SCHOOL OF NAVIGATION, Dept. 3, Annapolis, Md.

"YOU ARE UNDER ARREST!"



Help Bring Crooks to Justice Through Scientific CRIME DETECTION!

We have taught thousands this exciting, profitable, pleasant profession. Let us teach you in your own home. Learn Fingerprinting, Firearms Identification, Police Photography, Secret Service Methods thoroughly, quickly, at small cost. Over 800 of all American Bureaus of Identification employ I. A. S. students or graduates. We can prepare you for this fascinating work, during spare time. Write today, stating age, for "Blue Book of Crime."

INSTITUTE OF APPLIED SCIENCE, 1920 Sunnyside Ave., Dept. 1369, Chicago 40, Ill.

THERE'S MONEY IN CARTOONS!

RAYE BURNS will teach you HOW to CREATE ORIGINAL CARTOONS at home that you may SELL! Course contains 26 lessons and over 600 illustrations. All for Only... **\$2.85**

Send name and address for free details.

RAYE BURNS SCHOOL, Dept. 8, Box 3583, CLEVELAND, OHIO

Enjoy WORLD'S MOST FASCINATING HOBBY! SEND FOR FULLY ILLUSTRATED BOOK TODAY!



GET THE FACTS on model railroading! Leading authority shows how easily, inexpensively you can join in the absorbing hobby enjoyed by thousands of mechanics, business and professional men. Scale model railroads look, perform like the real thing! GET STARTED NOW! Send 10¢, coin or stamps, for illustrated booklet, "Model Railroading for You". MODEL RAILROADER MAGAZINE Dept. 1612, Milwaukee 3, Wis.

WAR SURPLUS OPTICAL BARGAINS

ASSEMBLE YOUR OWN BINOCULARS!
Complete Optics! Complete Metal Parts!
Save More Than 1/2 Regular Cost

GOVERNMENT'S 7x50 BINOCULARS



Complete Optics, new and ready for assembly. We supply full instructions. Limit—1 Set of Metal Parts and 1 Set of Optics to a customer.

METAL PARTS—Set includes all Metal Parts—completely finished—for assembly of 7 X 50 Binoculars. No machining required. Bodies have been factory hinged and covered. A sturdy Binocular Carrying Case is optional with each set of Metal Parts.

Stock #842-N \$39.40

Postpaid, plus \$4.80 for Case—Total \$44.20

OPTICS—Set includes all Lenses and Prisms you need for assembling 7 X 50 Binoculars. These are in excellent condition—perfect or near-perfect—and have new low reflection coating.

Stock #5102-N \$25.00 Postpaid

NOTICE! If you buy both Binocular Optics and Binocular Metal Parts, add 20% Federal Excise Tax to above prices.

ARMY'S 6x30 BINOCULARS

No carrying Case with any Sets shown below. M-13A1 sets are waterproof model. M-3 sets are not waterproof.

COMPLETE OPTICS & METAL PARTS—Model M-13A1, 6 x 30 Binoculars. Everything you need—ready for assembly. When finished will look like a regular factory job costing \$102 to \$120. The Optics are new, in perfect or near-perfect condition. Have new low reflection coating. Metal Parts are new and perfect, all completely finished. No machining required. Bodies factory hinged and covered. Complete assembly instructions included.

Stock #830-N \$40.00 Postpaid, plus \$8.00 tax—Total—\$48.00

COMPLETE OPTICS & METAL PARTS—Model M-3, 6 x 30 Binoculars. The Optics in this set are new, perfect or near-perfect. Prisms have new low reflection coating. Factory mounted Eye Piece and Objective Assemblies not coated. Metal Parts are perfect, new, ready for assembly. When finished, this will look like a regular factory job, except a name has been filed off a cover plate. No machining required. Bodies factory hinged and covered.

Stock #831-N \$35.00 Postpaid, plus \$7.00 tax—Total—\$42.00

METAL PARTS ONLY—Model M-13A1, 6 x 30 Binoculars. No Optics. Same Metal Parts as described for Stock #830-N.
Stock #832-N—6 x 30 Metal Parts \$25.00 Postpaid
OPTICS FOR 6 x 30 BINOCULARS (No Metal Parts.) Perfect, and low reflection coated. Stock #5130-N \$15.00 Postpaid
SAME OPTICS AS ABOVE (6 x 30) Coated—but slight seconds.

Stock #5124-N \$12.75 Postpaid
If you buy both the Binocular Optics and the Binocular Metal Parts, your purchase becomes subject to 20% Federal Excise Tax. Be sure to add amount covering tax to your remittance or your order cannot be filled.

Optics and Metal Parts are Available for Monoculars (1/2 a Binocular). For Complete Details, Write for Bulletin #14-N.

\$15.00 BUYS A \$500.00 TELESCOPE WITH BIG 3" OBJECTIVE



3 power instrument, brand new with plastic Optics and fixed focus. Objective Lens has F.L. of 14.9" 23" long. Wt. 31 lbs. Wide field of view.

Stock #929-N \$15.00 f.o.b. Chicago, Ill. (Shipping Wt. about 70 lbs.)

35 MM KODACHROME PROJECTING LENS SET—Consists of Achromatic Lens for projecting, plus a Condensing Lens and piece of Heat Absorbing Glass with directions.

Stock #4025-N \$1.95 Postpaid

SATISFACTION GUARANTEED

EDMUND SALVAGE CO., P. O. Audubon, New Jersey

NEVER HAS THERE BEEN SUCH A SENSATIONAL BARGAIN AS THIS!
BUBBLE SEXTANT—TYPE A-10

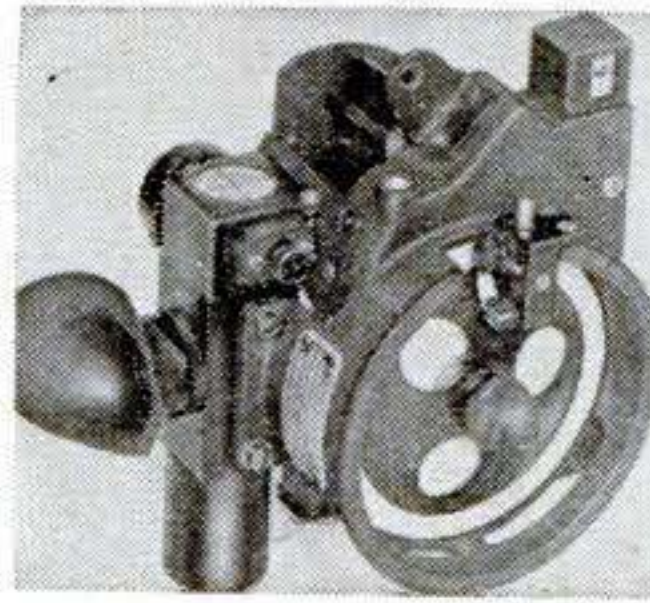

These Army Air Forces Bubble Sextants cost the Govt. about \$125.00 each. A real bargain at our price of \$12.50! Included with Bubble Sextant shipment is wooden Carrying Case, 5 spare waxed paper discs, flashlight with rheostat for night use (uses ordinary flashlight cells—not furnished) aux. 2-power Galilean Telescope, Allen wrench, 1 spare marking point. Wartime used, but where necessary completely repaired, collimated and put in good working order. If not satisfied that Sextant is exactly as represented, return within 10 days and money will be refunded. Full directions for use accompany each shipment.

Stock #924-N \$12.50 Postpaid

TYPE A-10-A, BRAND NEW! Same Sextant as above, but new and with Automatic Electric Averaging Device and Illuminated Averaging Disc for nighttime use. Govt. cost \$217. Though brand new we have re-checked Bubble and Collimation and GUARANTEE perfect working order.

Stock #933-N \$22.50 Postpaid

CONDENSING LENSES—Seconds, but suitable for Enlargers and Spotlights.

Stock #1061-N 6 1/2" dia., 9" F.L. \$2.50 Postpaid

Stock #1082-N 4 1/2" dia., 5 1/2" F.L. 70¢ Postpaid

We Have a Limited Quantity of Condensing Lenses—seconds—ranging from 4 1/2" to 8 1/2" in dia. with various focal lengths. Send for Free Bulletin titled "MISCELLANEOUS CONDENSING LENSES—N"

POLARIZING VARIABLE DENSITY ATTACHMENT FOR BINOCULARS

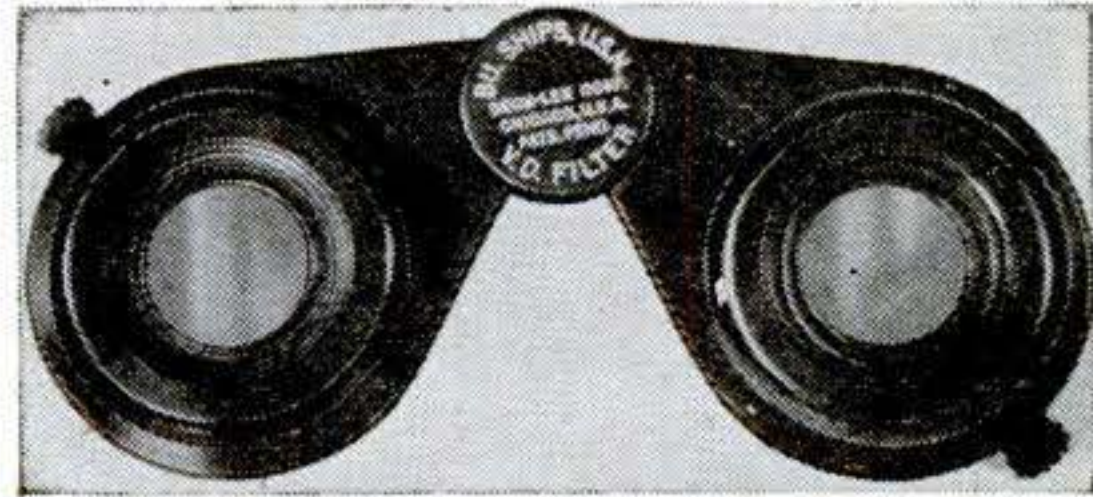

An amazingly effective unit for controlling amount of light reaching your eyes. Cuts down glare in sky and overwater observations. Easily snapped on and off over the eye cups of American-made 7x50 Binoculars Govt. cost \$8.30 each.

Stock #20,000-N \$2.00 Postpaid

Above Polarizing Attachment also adaptable to Govt. 6 x 30 Binoculars with substitution of special Eye-cups.

Stock #20,010-N 6 x 30 Eye-cups 75¢ pr. Postpaid



MOUNTED PROJECTING LENS SYSTEM

F.L. 91.44 mm. (just right for 35 mm. Projectors). Speed of F 1.9. Outside dia. of mount at one end 60 mm. Length of mount 64 mm.

Stock #4033-N \$3.00 Postpaid

MOUNT FOR ABOVE PROJECTING LENS SYSTEM

Stock #715-N \$1.50 Postpaid

LENS CLEANING TISSUE—1st quality, sheet size 11" x 7 1/2". Made to Govt. specs. Won't dust. Free of abrasives and lint.

Stock #721-N 500 sheets \$1.00 Postpaid

SCHMIDT OPTICAL SYSTEM. Black plastic body, size 3-15/16" by 5-1/2". F.L. 2.4" with amazing speed of F.O.9. Used in Navy's Infra-Red Sniperscope and Signaling Units. Govt. cost \$134. Limit—1 to a customer.

Stock #720-N \$6.00 Postpaid

AIR FORCES GUN SIGHT—With Polarizing Variable Density Attachment. (Polarizing attachment alone is worth many times the price of entire unit.)

Stock #908-N \$5.00 Postpaid

Same Unit Without Polarizing Attachment

Stock #916-N \$2.50 Postpaid

We have literally millions of war surplus lenses and prisms for sale at bargain prices. Write for Catalog "N"—Sent Free!

Order by Stock No.

Do you want

- .. to go to College?
- .. or to enter a Profession?
- .. or get an Office Position?

(Such as Accounting, Architecture, Nursing, Dentistry, Teaching, Social Work, Osteopathy, Beauty Culture, Optometry, Embalming, Chiropody, Law, Medicine, etc.)

To get anywhere, you practically **MUST** finish High School **FIRST**. You can complete our simplified High School Course in **SPARE** time at home, as **FAST** as your time and abilities permit. Equivalent to resident school work—prepares you for college, pre-professional examinations, business, industry. Standard texts furnished. Diploma. Credit for H.S. subjects already completed. Single subjects if desired. Low tuition, easy terms. American School, Chicago, est. 1897—endorsed by educators. Finish your high school education **NOW**. Write **TODAY!**

High School Course at Home

Many Finish in 2 Years

American School, Dept. H946, Drexel Ave. at 58th St., Chicago 37

Gentlemen: Send me **FREE** information covering special training in subjects checked below. No obligation on my part.

- | | |
|--|--|
| <input type="checkbox"/> High School Course | <input type="checkbox"/> Diesel Engineering |
| <input type="checkbox"/> Electronics, Industrial | <input type="checkbox"/> Drafting and Design for Men and Women |
| <input type="checkbox"/> Architecture and Building | <input type="checkbox"/> Plastics |
| <input type="checkbox"/> Automotive Engineering | <input type="checkbox"/> Private Secretary |
| <input type="checkbox"/> Business Management | <input type="checkbox"/> Mechanical Engineering |
| <input type="checkbox"/> Electrical Engineering | <input type="checkbox"/> Aviation |
| <input type="checkbox"/> Elec. and Gas Refrigeration | <input type="checkbox"/> Salesmanship |
| <input type="checkbox"/> Air Conditioning | <input type="checkbox"/> Radio |
| <input type="checkbox"/> Railway Training | |

Name.....

Address.....



Embry-Riddle

TRAINING COUNTS MOST IN AVIATION

Get the right kind of training for a **SUCCESSFUL AVIATION CAREER** at Embry-Riddle's internationally known School of Aviation—in air-minded Miami. Intensive, practical courses—CAA approved. Authorized training under G. I. Bill.

You can become a flying mechanic or a certificated A & E mechanic. Or study radio; airplane operation and maintenance; design engineering; flight. Instruction covers whole field of aviation. Immediate enrollment.

It's always Summer in colorful Miami—the aerial crossroads of the Americas!

MAIL THIS COUPON—TODAY!

Dean of Enrollments—Dept. 51-A
Embry-Riddle School of Aviation
Miami 30, Florida

Send free information on Aviation Training to:

Name.....Age.....

Address.....

City.....State.....

Check One Veteran Non-Veteran

5 COURSES TO SUCCESS

CLASSES ENROLLED MONTHLY
Time-saving practical courses—day and evenings. Approved for G.I. Training. Free Placement Service. Write for **FREE CATALOG**

- TOOL and DIE DESIGNING**
- MECHANICAL DRAFTING**
- ARCHITECTURAL DRAFTING**
- INDUSTRIAL PROD. DESIGNING**
- AUTOMATIC SCREW MACHINE ENGINEERING** Cam Design Layout and Estimating

MIDWESTERN TECHNICAL INSTITUTE

431 S. Wabash, Auditorium Bldg., Dept. YC, Chicago 5, Ill.

LAW FREE BOOK



Write today for **FREE** 48-page book, "THE LAW-TRAINED MAN," which shows how to learn law easily in spare time at home through the Blackstone course prepared by 60 well-known law authorities. We furnish all material including 18-volume Modern American Law library. Many successful attorneys among our graduates. LL.B. degree. Moderate cost; easy terms; Money-Back Agreement.

BLACKSTONE COLLEGE OF LAW
225 N. Michigan Ave., Dept. 129, Chicago 1, Ill.
A Correspondence Institution Founded in 1890

LEARN MOVIE PROJECTION THEATRE MANAGEMENT

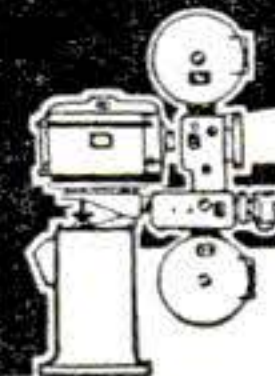

The Motion Picture Theatre Business offers big opportunities for trained men. Get into a fascinating field with a promising future. Train at home in spare time. Free Catalog. Established 20 years.

THEATRE INSTITUTE, 385 Washington St., Elmira, New York

Big Money for Workers In Home or Shop



Licensed Concrete Specialists wanted. No experience needed. Make *Colorglazed* concrete pottery without molds. New, low cost, patented method. Cemetery products, novelties, tiles, floors, etc. Basement leaksealing. Other big pay projects. Booklet, details free. Men only.

NATIONAL POTTERIES COMPANY
415 West Third Ave. Grand Rapids, Minnesota

Learn RADIO TELEVISION ELECTRONICS

Our proven 2-Way Instruction trains you at home in spare time for a good pay job or a business of your own. For **FREE** book "Your Opportunities in Radio", write: Hollywood Radio & Television Institute (Established 1929), Dept. D-11, 810 W. 6th St., Los Angeles, Calif.

OLD GOLD JEWELRY WANTED

Dental gold teeth, plates and bridges with metal attached. Any broken pieces of gold jewelry. Immediate payment and free mailing container to you or your friends upon request.

LOWES, DEPT. PS Holland Bldg., St. Louis 1, Mo.

ELECTRIC LIGHT JAZZ BOW TIE!

Astonish, amaze your friends. Be the life of the party. Have lots of fun. Easily put on. Flashes on and off by simply pressing battery button hidden in your pocket. Complete with attractive bow tie, and, two bulbs and battery. Mail your order today. Special prices on all articles to dealers.

\$1.95



BERNARD FINE CO., INC.

501 Sixth Ave. Dept. PSM7 New York 11, N. Y.

BURIED TREASURE. MINERALS AMAZING NEW GOLDAK LOCATORS

SENSATIONAL NEW MODEL!

ONLY 11 pounds weight! One hand operation! Money-Back Guarantee of Superiority. Write for full details.

THE GOLDAK CO.
1544 WEST GLENOAKS BLVD.
GLENDALE 1, CALIFORNIA

World's largest maker of fine locators.



AMERICAN BOYS BILL OF RIGHTS

We... The Boys of America

believe in these **OUR RIGHTS**: the right to **LIBERTY**, hard-won by our forefathers & the right to **HAPPINESS** that comes with the growth of a healthy body and mind & the right to **TRAINING**, thoughtfully planned by parents, school and church & the right to **OPPORTUNITY**, to live, learn, play and grow up in the time-honored traditions of a free people & and the right to learn to **SHOOT SAFELY**. We recognize and accept the responsibility imposed by these Rights. But & until we are old enough to vote & we expect **YOU** & our fathers, mothers and other citizens who elect America's city, county, state and federal officers & to be eternally vigilant that our **RIGHTS** be not abridged!

"The rights of the people to keep and bear arms shall not be infringed!"
(Quotation from the Second Amendment to the United States Constitution)

PICTURE FOR YOUR ROOM WALL!

A beautiful, large-size, full color reproduction of the American Boy oil painting and Boys Bill of Rights, suitable for sticking or thumb-tacking to your room wall... is yours postpaid for only 15c plus 3c unused stamp.. Order now!



GET YOUR DAISY HANDBOOK

For safer shooting, more fun. Comic strips, jokes, inventions, jet propulsion, cowboy lore, complete Daisy Catalog, etc. Pocket-size. Send 10c, unused 3c stamp, and coupon below!



BIG BARGAIN SPECIAL!

We'll send postpaid both Bill of Rights oil painting reproduction and Handbook... for only 25c in coin. while supply lasts. Hurry!

GIVEN! DAISY COMMANDO
—with Your Order for

BUCK ROGERS ATOMIC PISTOL HOLSTER SET!

READY! Surprise GIFT Offer: send only \$1.59 plus 11c for postage-handling and we'll mail postpaid Buck Rogers Atomic Pistol Holster Set—and while supply lasts—INCLUDE the Daisy Commando without extra cost... so hurry! Both guns safe, harmless. Ideal gifts for children 4 to 11. **ATOMIC PISTOL:** 10" long, all metal. Makes loud "ZAP!" noise, flashes harmless red when you pull trigger. **ATOMIC HOLSTER:** Real 2-tone leather belt, straps, nickel-plated buckle, studdings, 25th Century style. **COMMANDO:** full 30" long, gun sling, pump action repeater. Loud "BANG!" each time you pump! Durable wood. Order now—show this to your parents!

\$1.59 Plus 11c Postage

Your Name.....
St. & No.....
City..... State.....

DAISY AIR RIFLES
BULLS EYE SHOT and
DAISY MANUFACTURING COMPANY
6011 Union St., Plymouth, Michigan, U. S. A.

DAISY TARGETEER PISTOL
Safe family fun gun! Air pistol, 500 shot, spinning "birdie" targets, target cards. Ask Dealer.

DAISY MANUFACTURING COMPANY, 5512 UNION ST., PLYMOUTH, MICHIGAN, U. S. A.

Rush to me postpaid your:

BILL OF RIGHTS PICTURE!
 I enclose 15c coins plus 3c stamp.

DAISY HANDBOOK!
 I enclose 10c plus 3c stamp.
 PICTURE & HANDBOOK BARGAIN!
 I enclose 25c. Send me both.

Name.....
St. and No.....
City..... State.....

DAISY MANUFACTURING CO., 5512 UNION ST., DEPT. 7, PLYMOUTH, MICHIGAN, U. S. A.

ELECTRICIANS

Get this Great Book FREE

Book of 150 Shop Prints, Wiring Diagrams, Full Size 8 1/2" x 11"



For Merely Examining Coyne's NEW Pay Raising

7 Volume Set APPLIED ELECTRICITY

Here's a brand new set of electrical books to give you the "know how" on all branches of electricity from appliance repairing to D. C. and A. C. equipment, electrical refrigeration, etc. 3,000 subjects, 10,000 facts, latest methods all explained in easy to follow instructions. In order to prove how valuable and Practical this set of electrical books is I'm willing to give you a FREE copy of my book "150 Shop Prints and How to Read Them" just for looking over this set. Written by the Coyne Technical Staff and backed by 47 years' experience, this set has helped many ambitious electrical workers to bigger pay, better jobs & added opportunity.

OFFER LIMITED - ACT NOW! Here's my offer to you - if you act promptly. I'll send you the 7 volume set Applied Practical Electricity for 7 days FREE examination... together with the 150 Shop Print Book. Look the set over 7 days. If you like it send either \$19.75 cash or send \$3.00 after 7 days and \$3.00 per month until \$21 is paid. If you don't want the set, return it and YOU OWE NOTHING. In either event, however, you keep the 150 Shop Print Book absolutely FREE.

SEND NO MONEY! Coupon below is just a request to see the books free and to get my gift book for doing it. ACT - Send coupon Today!

FREE BOOK Coupon

Coupon below is just a request to see the books free and to get my gift book for doing it. ACT - Send coupon Today!



B. W. Cooke, Director
COYNE ELECTRICAL SCHOOL, Dept. 97-R8, 500 SOUTH PAULINA STREET, CHICAGO 12, ILLINOIS

O. K., send me, postpaid, Coyne's new 7 volume, "Applied Practical Electricity" for 7 days FREE TRIAL per your offer. Also send, absolutely FREE, the book of 150 Shop Prints as a gift.

NAME _____ AGE _____

ADDRESS _____

TOWN _____ ZONE _____ STATE _____

Santa Rides Again!

SEND FOR THIS NEW

FREE

SUPPLEMENT & GIFT GUIDE

SUPER VALUES FOR YOUR LIST—FOR YOURSELF

- ★ save money!—new low-cost offerings in P. A., "ham" equipment and wanted radio parts.
- ★ miracle Lafayette FM tuner, sensational buy!
- ★ rich console radio with automatic record player, under \$100.
- ★ selection of small home electrical appliances.

... and lots more.

Lafayette Radio

RADIO WIRE TELEVISION, INC.

100 Sixth Ave., N. Y. 13 • 542 E. Fordham Rd., Bronx 58
 110 Federal St., Boston 10 • 24 Central Ave., Newark 2, N. J.

LAFAYETTE RADIO, Dept. KL-7

100 Sixth Ave., New York 13, N. Y.

Rush new Supplement & Gift Guide #885.

Name.....

Address.....

City..... Zone..... State.....

Learn to Write

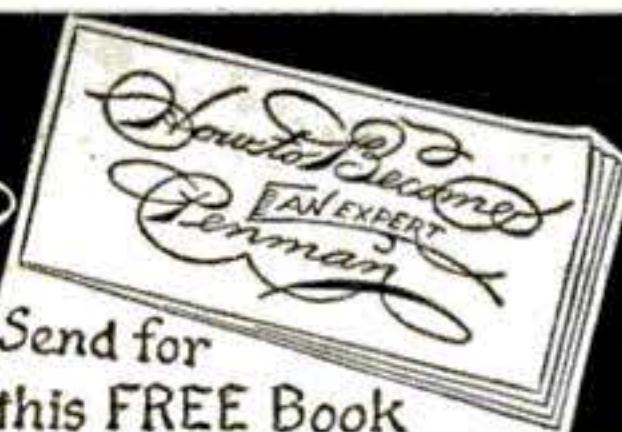

GOOD PENMANSHIP makes favorable impressions and helps you win success. Poor penmanship contributes to failure. It makes no difference how poor you now write, you can quickly and easily learn **Business Writing**, and you can learn **Shaded Writing** also right in your own home during spare time by my **Simplified Method**, without cost of going away to school. Easy Lessons. Diploma.

Send for this FREE Book

BEGIN NOW! Write for my FREE BOOK, "How to Become an Expert Penman," which contains valuable information and many specimens of penmanship that show what others have learned by taking my Courses. If you enclose 10c, I will send you one of my Favorite Penpoints suitable for plain or shaded writing, and your name with a beautiful flourished bird written on a card. Write TODAY.

T. M. TEVIS, BOX 25R, CHILLICOTHE, MO.

INDIANA TECHNICAL COLLEGE

ENGINEERING B. S. DEGREE IN 27 MONTHS. Aeronautical, Chemical, Civil, Electrical, Mechanical and Radio Engineering (inc. television). Drafting, 1-yr. Gov't approved for G.I.'s. Low rate. Earn board. Large industrial center. Students from 48 states. Demand for grads. Enter Dec., March, June, Sept. Catalogue. 6127 E. Washington Blvd., Ft. Wayne 2, Ind.



CARTOONING

HAVE FUN! MAKE MONEY! Cash in on your sense of humor at HOME—BY MAIL. No experience needed to start. Write today FOR FREE TRIAL LESSON and full particulars. 54 LESSON COURSE—ONLY \$2.75. Moon Gag Cartoon School, Dept. C, Fall Creek, Wis.

AMAZING DISCOVERY! Guides hand—Corrects your penmanship in few hours.

Improves Handwriting In 3 Hours

Write, OZMENT, 35-C, St. Louis, Mo.

Learn BAKING At Home

Baking is one of America's high industries in wages. Nearly depression-proof. Thorough basic home course lays sound foundation. If you have aptitude, write for FREE BOOKLET, "Opportunities in Commercial Baking."



National Baking School, 1315 Mich. Ave., Dept. 1369, Chicago 5

STAMMER?

This new 128-page book, "Stammering, Its Cause and Correction," describes the Bogue Unit Method for scientific correction of stammering and stuttering—successful for 46 years. Benj. N. Bogue, Dept. 7854, Circle Tower, Indianapolis 4, Ind.



make your own Gems 29.50 F.O.B.

All necessary lapidary equipment is furnished, including a super-charged diamond blade for sawing, and all wheels for grinding, shaping and polishing; also complete instructions. The complete equipment as shown, less motor and belt, for only \$29.50, f.o.b., Burlington, Wisconsin. Write today for information and literature.

B&I MANUFACTURING CO.
 Dept. M — Burlington, Wis.

BUILD THIS CONCRETE BLOCK MACHINE

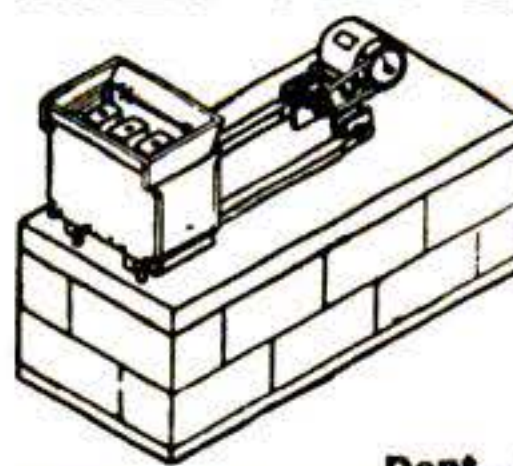

Sell blocks; or build your home, garage, barn, or filling station at 1/3 cost by making and laying your own blocks. This simple machine which you can build yourself at a cost of \$15 (excluding motor) will make a block in 30 seconds using only one form. Mass production can be achieved by a new simple method of removing blocks which allows two to four forms to one vibrator. Power driven concrete mixer plans also. Send dime for details and "How to Make and Lay Blocks" folder.

U-BUILD-IT SERVICE
 Dept. 4-A, 206 West Wilder St., Tampa 3, Florida

RUPTURED?

Get Relief This Proven Way

Why try to worry along with trusses that gouge your flesh—press heavily on hips and spine—enlarge opening—fail to hold rupture? You need the Cluthe. No leg- straps or cutting belts. Automatic adjustable pad holds at real opening—follows every body movement with instant increased support in case of strain. Cannot slip whether at work or play. Light. Waterproof. Can be worn in bath. Send for amazing FREE book, "Advice To Ruptured," and details of liberal truthful 60-day trial offer. Also endorsements from grateful users in your neighborhood. Write:

Cluthe Sons, Dept. 14, Bloomfield, New Jersey



The **WORLD'S FINEST** **SURPLUS BARGAINS**

GENERAL ELECTRIC BC 645 TRANSCEIVER

Ideal for two way communication on the new citizens radio band between house and automobile, boats, around ranches, etc. Covers 450-500 megacycles. Cost Gov't over \$400.00 as aircraft unit. Brand new with 15 tubes, (list price tubes alone \$58). Conversion data to ham bands, and 110 V. operation. In original sealed GE cartons. Shipping **\$14.95** ^{2 for} **\$27.00** Wt. 25 lbs.

BRAND NEW ARMY AIR FORCE ASTROGRAPHS
ORIGINAL COST \$125. **Only \$3.95**



Thousands of uses. An ideal navigation instrument for boats, yachts, etc. A wonderful unit for home construction of contact printers, enlarger, strip map holder, etc. A beautiful precision instrument consisting of machined aluminum housing with optical glass view plate, two large ratchet film drive knobs and shafts, one film spool, variable light source slide and holder, illumination control rheostat, resistor, power plug and tools. All housed in beautiful plywood case measuring 14 1/2 x 11 x 10" high. Case has leather handle, steel reinforced corners, hinged lid with stop, lower compartment divided into eight sections. Case is ideal for fishing kit, picnic set case, tool kit, portable radio case, make-up kit, travel case. Case alone worth twice the giveaway price we are asking for both. Shipping weight, 20 lbs.

DYNAMOTORS

Consists of electric motor operating generator on same shaft. Many applications — operating radios from storage battery — using as motor.
Dynamotor A—Input 12 volts, output 1000 volts at 350 MA, Shipping weight, 72 lbs. ... **\$7.95**
Dynamotor B—Input 6 or 12 volts, output 350 volts, 360 MA. Shipping weight, 30 lbs. ... **\$5.95**
Dynamotor C—Input 28 volts, output 220 volts at 60 MA. Shipping weight, 6 lbs. **\$1.50**

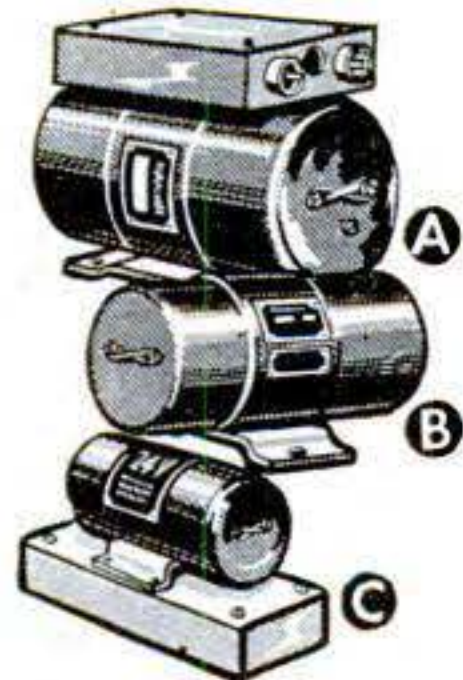

MINIATURE HEADPHONES



Miniature type headphones. Ideal for hearing aids, listening to radio in bed, etc. Complete with headband, cord and two sets rubber ear plugs. Shipping weight, 1 1/2 lbs. **ONLY \$1.00**

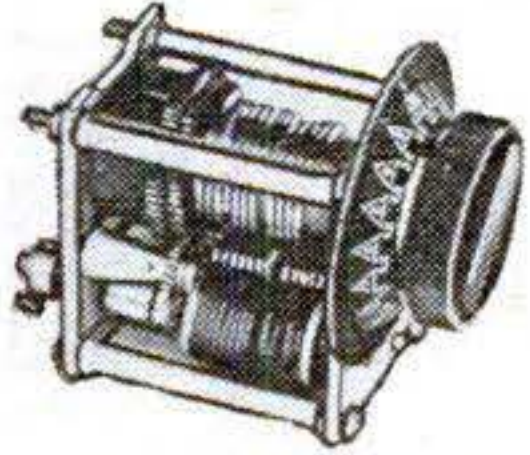

DIAL ASSEMBLY

This beautiful unit has dozens of parts useful to home builders. Contains gears, cams, clutch and other mechanisms from Army transmitter. Shipping Wt. 2 lbs. **\$1.00**

THROAT MICROPHONE

Brand new Army T-30 throat microphones. Used in aircraft, tanks, etc. Broadcast through your radio, use in noisy factories, for home telephone systems, hundreds of applications. Shipping Wt., 1 lb. **\$1.00**



GENERATOR

Makes an excellent home lighting plant and can be operated by wind propeller, waterfall, gas engine, or hand crank. Reduction gear allows full output at very slow speed; supplies 6 volts at 2.45 amp., 425 volts at .115 amp. Brand new, GN-58. Shipping Wt., 28 lbs. **\$7.95**

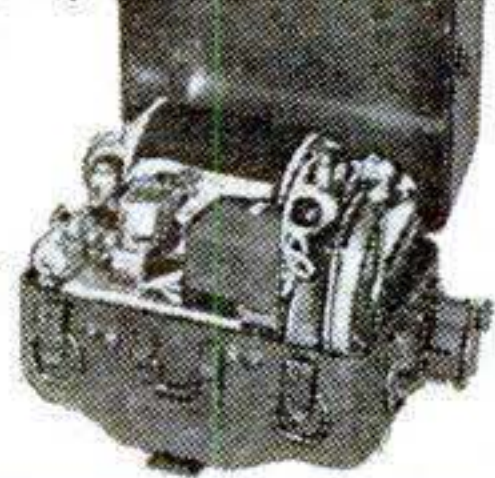

ELECTRONIC KIT

Experimenter's paradise. Five lbs. of new condensers, transformers, coils, switches, sockets, resistors, selenium rectifier, earphones, etc. Parts for dozens of experiments. Shipping Wt., 6 lbs. **\$1.00**

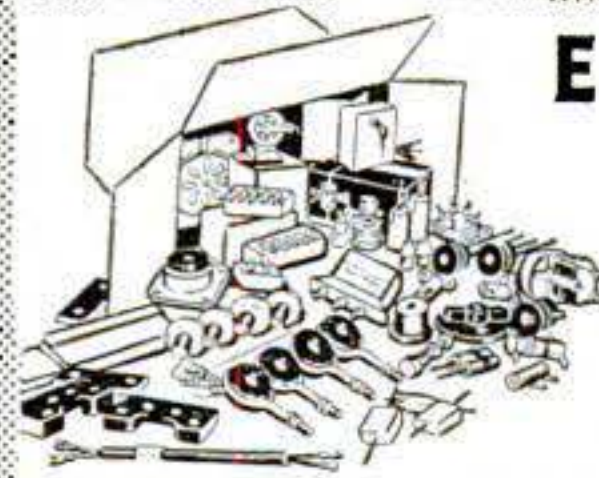

TUNING UNIT

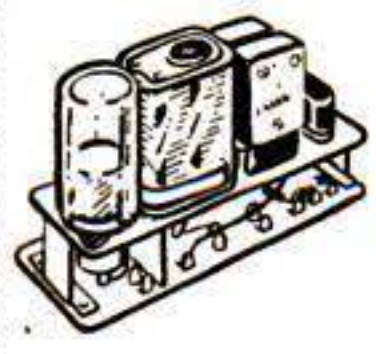

The heart of the Army Walkie-Talkie. Contains transmitter crystal and tank coil, receiver coil, tuning condenser and crystal; ideal foundation for small set. Shipping Wt., 1 lb. **\$1.00**

Miniature ELECTRIC MOTORS

Ideal for powering all kinds of models. Runs on 24 V. D.C. One of the smallest motors made. 1 1/4" x 1" x 2" Cost Gov't nearly \$20. Shipping Wt. 1 lb. **\$2.95**



HEATHKIT VACUUM TUBE VOLTMETER KIT

Build yourself this beautiful electronic volt-ohmmeter and save 2/3 of the cost. Measures both AC and DC with ranges 3-30-100-300-1000 volts and ohms .1 to 1,000,000,000 ohms. Every part supplied including printed panel, cabinet, 500 microamp meter, tubes, transformer, blueprints, and instructions. Shipping Wt. 8 lbs. **\$24.50** Complete kit



Include Postage for Weight Shown



The HEATH COMPANY
DEPT. S . . BENTON HARBOR, MICH.

1847 A CENTURY OF PUBLISHING MERRIAM-WEBSTERS 1947

The Handy-Sized Merriam-Webster

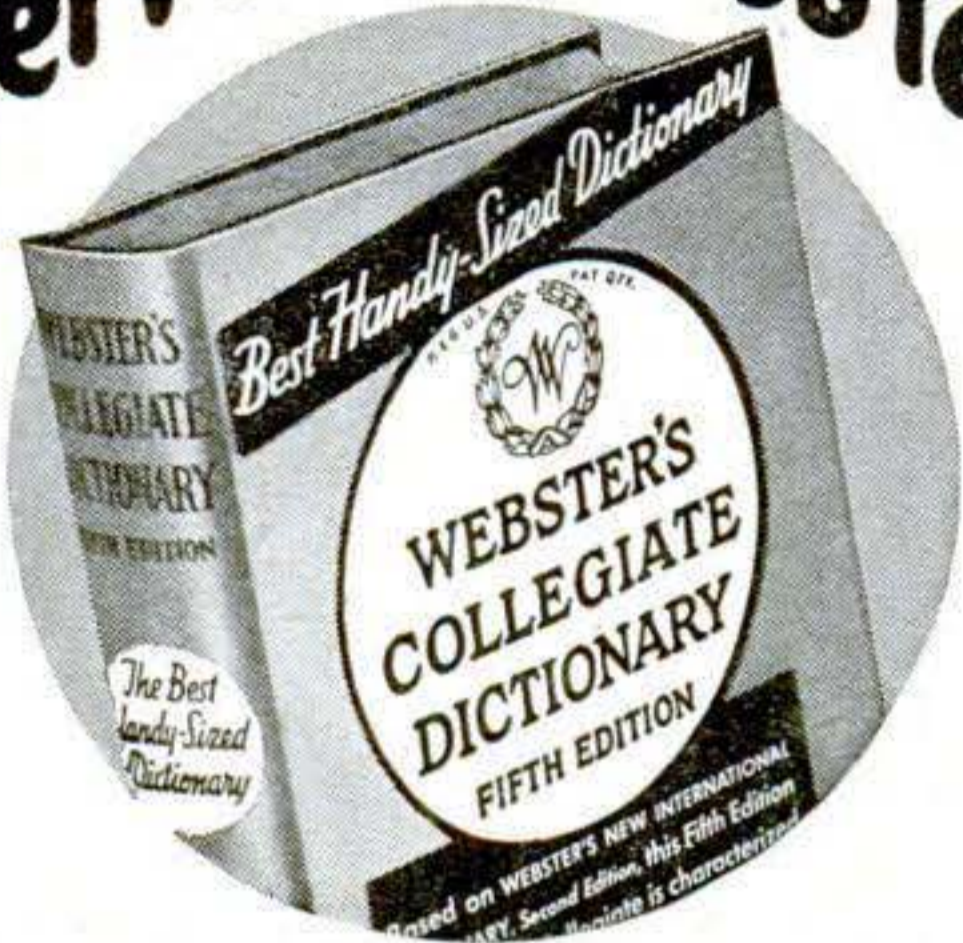

WEBSTER'S COLLEGIATE is the most dependable handy dictionary for home and office because it is a compact abridgment of the famous *Webster's New International Dictionary, Second Edition* — "The Supreme Authority." Defines all the words most commonly used. 1,300 pages; 110,000 entries. \$5 to \$10, depending on binding. Ask your bookdealer.
G. & C. MERRIAM CO., SPRINGFIELD 2, MASS.

AVIATION Career

MAXIMUM TRAINING IN MINIMUM TIME

CAL-AERO TECH TRAINING will add dollars to your pay check all the rest of your life. Specializing in AERONAUTICAL ENGINEERING and MASTER AVIATION MECHANICS since 1929, Cal-Aero Tech training is carefully designed for just one thing—TO MAKE MORE MONEY FOR YOU. An alumni of over 6000 successful graduates proves our career training is unsurpassed.

VETERANS —Write us about Aviation Training, as provided under "G.I. Bill of Rights."



CAL-AERO TECHNICAL INSTITUTE
MAJOR C. C. MOSELEY PRES. SINCE 1929
FORMERLY CURTISS-WRIGHT TECHNICAL INSTITUTE

GRAND CENTRAL AIR TERMINAL
GLENDALE 1, CALIFORNIA
LOS ANGELES COUNTY

MAIL THIS COUPON TODAY!

Cal-Aero Technical Institute, Grand Central Airport, Glendale 1, California
Please send full information on Aviation Training FREE—without obligation. Dept. PE 10

Name _____

Street _____

City _____ State _____



LET ME TEACH YOU



J. D. RICE

Head of Penmanship Dept. Chilli-cothe, Mo., Business College for 42 years. One of America's finest penmen.

at home in your spare time. Amaze your friends by the skill you can acquire in a short time. Artistic Writing will win you prestige, admiration and respect; help you influence prospective employers.

NO LESSONS TO SEND IN—My new course **ARTISTIC PENMANSHIP SELF TAUGHT** is practical, makes artistic writing easy. No teacher is necessary. Just practice fascinating step-by-step exercises on forms provided and you'll be amazed how quickly you become proficient. Contains same type material as expensive courses yet costs you only \$2.95 postpaid complete with special pens for shaded writing. Send for your course **RIGHT NOW**. (Currency may be mailed if carefully wrapped.) Money Back If Not Satisfied.

EDUCATIONAL PUBLISHERS, Dept. S-103
7241 Madison St. Kansas City 5, Mo.

ELECTRICAL TRAINING

Intensive 32 weeks residence course in fundamentals of industrial electrical engineering, including radio, electronics. Prepares for technician, engineering aides. Approved for veteran training. 54th year. Write for catalog.

BLISS ELECTRICAL SCHOOL
7622 Takoma Ave., Wash. 12, D.C.



"How to Make Money With Simple Cartoons"

A book everyone who likes to draw should have. It is free; no obligations. Simply address

CARTOONISTS' EXCHANGE

Dept. 1912-D

Pleasant Hill, Ohio

TRI-STATE COLLEGE

B.S. Degree in 27 months in Civil, Electrical, Mechanical, Chemical, Aeronautical, Radio Engineering, Bus. Admin., Acctg. and Sec. Science. 64th year. Enter Jan., March, June, Sept. Catalog. 5127 College Ave., Angola, Ind.

LAW

STUDY AT HOME for PERSONAL SUCCESS and LARGER EARNINGS. 39 years expert instruction—over 108,000 students enrolled. LL.B. Degree awarded. All texts furnished. Easy payments. G.I. Approved. Send for **FREE BOOK**.

AMERICAN EXTENSION SCHOOL OF LAW
Dept. 84-S, 646 N. Michigan Ave., Chicago, Ill.

AUXILIARY POWER PLANTS

Govt cost \$300. our Price \$40.
Description available. No C.O.D.

NEW YORK OUTLET & SALES CORP. 144 Chambers St. N.Y. 7 N.Y.

What Every Mason Wants



We have Important Masonic books for Blue Lodge, Chapter, Commandery, Scottish Rite, and Shrine.

OUR RITUALS ARE USED THE WORLD OVER

Send for free catalog of books and rituals for Masons, Odd Fellows, Knights of Pythias, Knights of Columbus, etc.
EZRA A. COOK, Publisher, P. O. 796, RD, Chicago 90, Ill.



LEARN MEAT CUTTING At Home — In Spare Time

Get into the vital meat industry. Concise, practical Home Training based on 25 years proven instruction methods used at National's famous resident school. Prepares you for bigger pay as Meat Cutter, supervision, market manager or more money in your own store. Go as rapidly as your spare time permits. Diploma. Start NOW to turn your spare hours into money. Send for **FREE** bulletin today. No obligation.

National School of Meat Cutting Inc., Dept. O-61, Toledo 4, Ohio

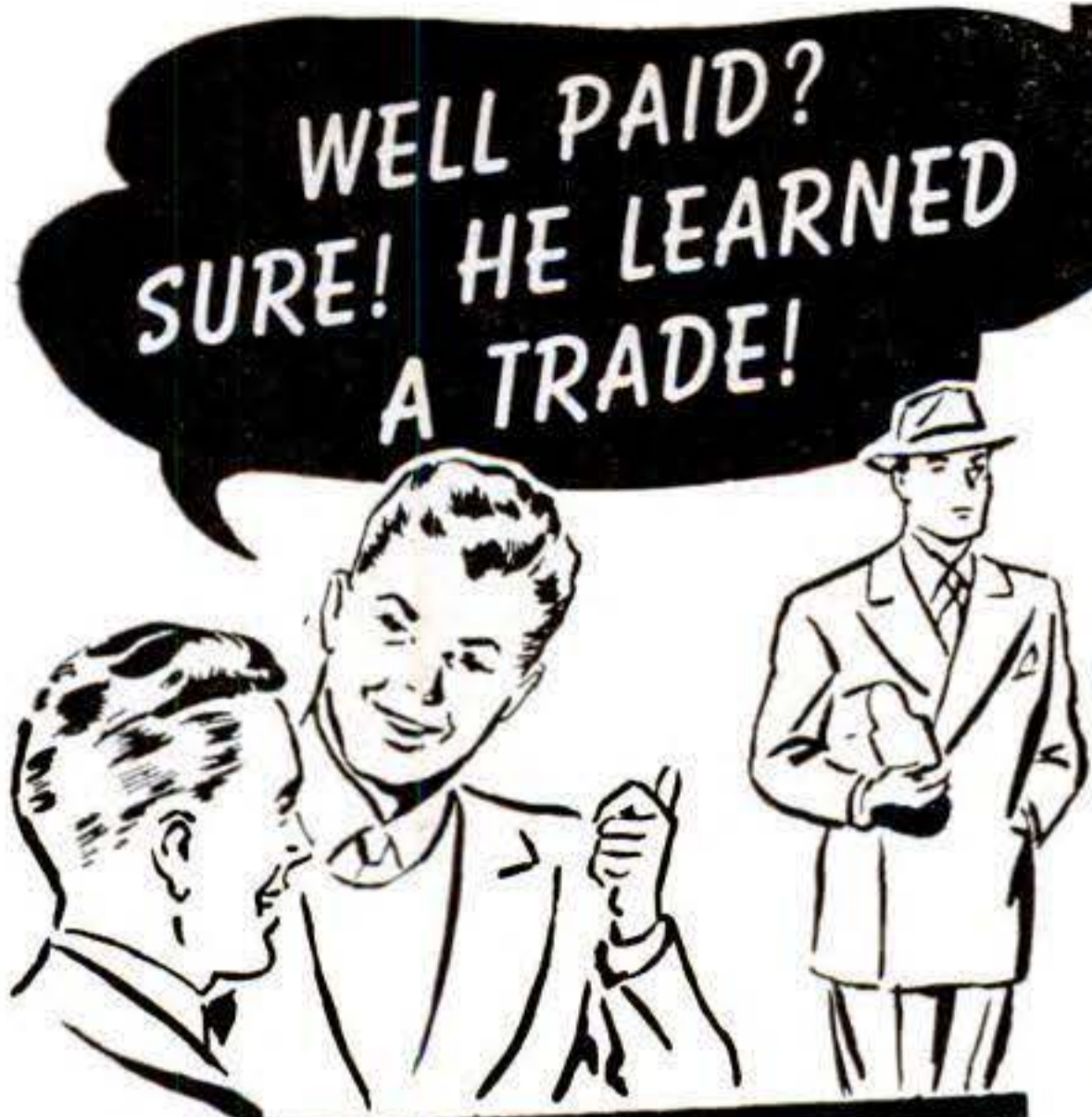

Young Man! Now You're Out of School...
YOU WANT TO GET AHEAD—MAKE MONEY

Choose from these 5 Trades

They Offer High Pay — Lifetime Work — Security

AUTOMOTIVE & TRACTOR Covers all phases of mechanical training, tune-up service, trouble shooting, repair, latest types model motors used for projects. **34 WEEKS.**

DRAFTING Elements and technique, drafting geometry, construction plans and specifications, auxiliary elevations, every phase. **32 WEEKS.**

PLUMBING Every step, from pipe cutting and threading, lead work, home and industrial installations, worked out in our own plumbing shop. **34 WEEKS.**

ELECTRICITY Basic principles, magnetism, current electricity, residential and industrial wiring, appliance repair **34 WEEKS.**

SHOE REPAIR From simplest repairs on boots and shoes to the finest details of reconditioning and rebuilding, under expert craftsmen **39 WEEKS.**

National Trade School, Dept. C 2610 Grand Ave., Kansas City 6, Mo.

Without obligation to me please send full information on the courses checked

..... Automotive and Tractor Technician Drafting
 Plumbing Electricity Shoe Repairing

Name..... Age.....
 Address.....
 City..... State.....
 Veteran?.....

"There's an Endless Demand for the Man Who Knows"

For YOUR lifetime career, learn one of these interesting and well-paid trades NOW. Be trained FOR the job, not ON it. All courses under especially trained instructors with practical experience. 6 hour Classes 5 Days a Week Our Employment Department helps you

VETERANS — If you qualify for any of these finer trade courses, your tuition and subsistence is paid by your government! Limited Enrollments. Don't miss this Opportunity!

Mail Today!

TO THOSE WHO THINK LEARNING MUSIC IS HARD

Just strike these notes and you're playing the beginning of the "Merry Widow" Waltz

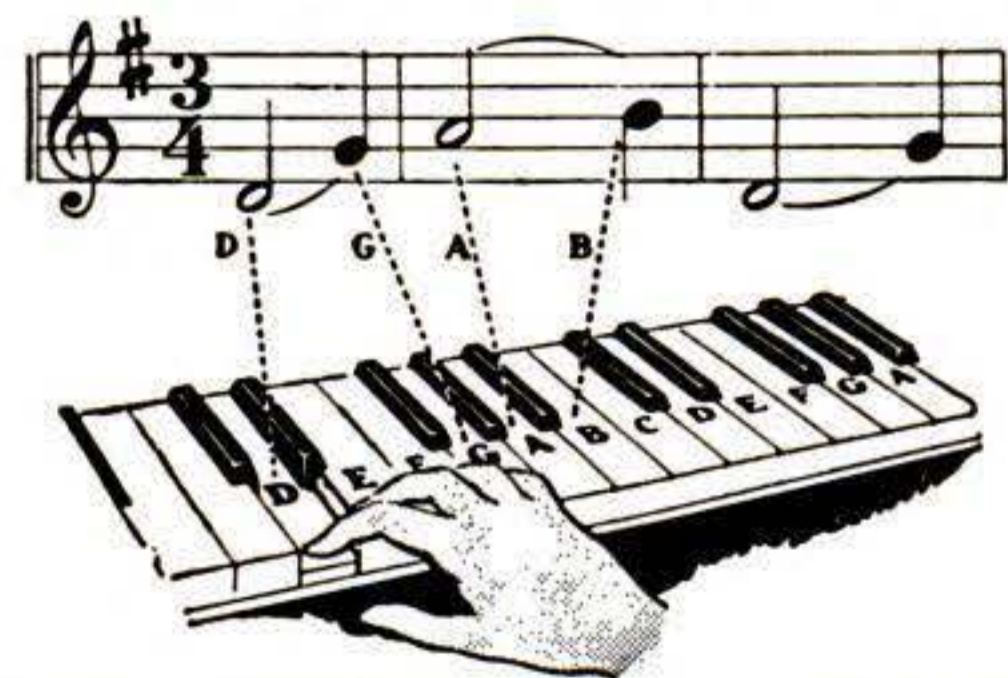

Look at the diagram. The first note of the music is "D." Following the dotted line to the keyboard you'll find "D" is the white key between the two black keys near the middle of the keyboard. Now read below how you can learn to play any instrument quickly and easily.



EASY AS A-B-C — COSTS JUST A FEW CENTS A DAY!

Perhaps you think learning music is a tedious grind. It isn't any longer! Long hours of practicing scales and monotonous exercise are over. You have no excuse for not getting started toward musical good times now! For through an easy method you can now learn to play right at home—without a teacher—for a few cents a day.

Learn to Play by Playing

The lessons come to you by mail from the famous U. S. School of Music... complete instructions, clear diagrams, and all the music you need. You learn to play by playing real tunes by note. First you are told how to do a thing. Then a picture shows you how. Then you do it yourself and hear it. Remember, don't confuse our method with any system claiming to teach music "by ear" or by trick methods. We teach you to play only from real notes!

SUCCESS!

Here's what one of our thousands of pupils writes: "I learned more from your course than many of my friends who studied under private teachers have for years. The fact that I've already taken 2 courses and am now enrolling for a third should speak for itself." F. A. S., Indiana.

Don't delay. Send now for our illustrated Free Booklet and "Print and Picture" Sample which fully explain this remarkable method. So decide which instrument you want to play and mail the coupon today. U. S. School of Music, 812 Brunswick Bldg., New York 10, N. Y. (Successful 49th Year)

FREE! Print and Picture Sample

U. S. School of Music, 812 Brunswick Bldg., New York 10, N. Y.

Please send me Free Booklet and Print and Picture Sample. I would like to play instrument checked below.

<input type="checkbox"/> Piano	<input type="checkbox"/> Saxophone	<input type="checkbox"/> Modern Elementary
<input type="checkbox"/> Guitar	<input type="checkbox"/> Trumpet, Cornet	<input type="checkbox"/> Harmony
<input type="checkbox"/> Hawaiian Guitar	<input type="checkbox"/> Reed Organ	<input type="checkbox"/> Mandolin
<input type="checkbox"/> Violin	<input type="checkbox"/> Tenor Banjo	<input type="checkbox"/> Practical Finger
<input type="checkbox"/> Piano Accordion	<input type="checkbox"/> Clarinet	<input type="checkbox"/> Control

Name..... Instrument?.....
 Address.....
 City..... State.....

Save 2c—Stick Coupon on Penny Postcard

YOU CAN NOW BECOME A PROSPECTOR!

HERE IS ONE OF THE WAR'S TOP SECRETS

BRAND (NEW) ARMY MINE DETECTORS!

Portable: Will Detect METALLIC and NON-METALLIC objects; Very Sensitive; using 955 Tube in detecting head; two tube amplifier using two 1N5gt; headset; or microphone; also 150 micro meter; Power supply; 3-45v.; one 6-v.; or 2 3-v. batteries. Complete with instr. Less Batteries; packed in original cases; shpg. wgt. 108 Lbs.

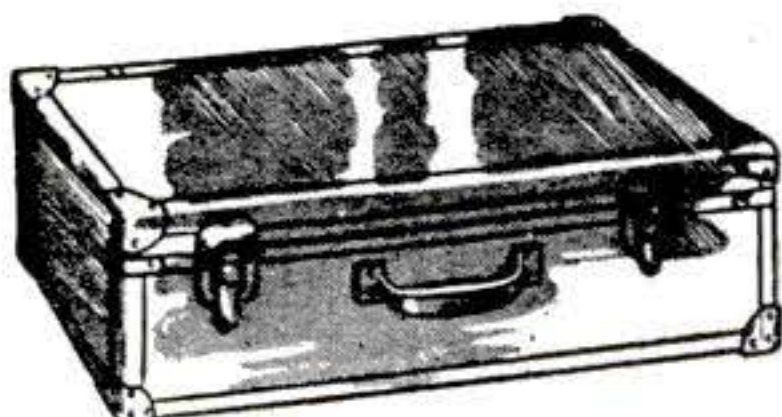

CARRYING CASE CY-91/PRS-1

F.O.B. from N. Y.

(Less Batteries) **\$17.50**

With Batteries **\$26.40**

F.O.B. N.Y.

NO C.O.D.

Send order to

COLUMBO TRADING CO., INC.

304 CANAL ST. Dept. PS-1 NEW YORK 13, N. Y.

Practical Shop Training In REFRIGERATION

Service, Maintenance, Installation and AIR-CONDITIONING

• Domestic • Commercial • Industrial

Approved for G. I. Training

Write for Details
COMMERCIAL TRADES INSTITUTE
202 So. 20th St., Birmingham, Ala.

• Train in the Magic City of the South. •

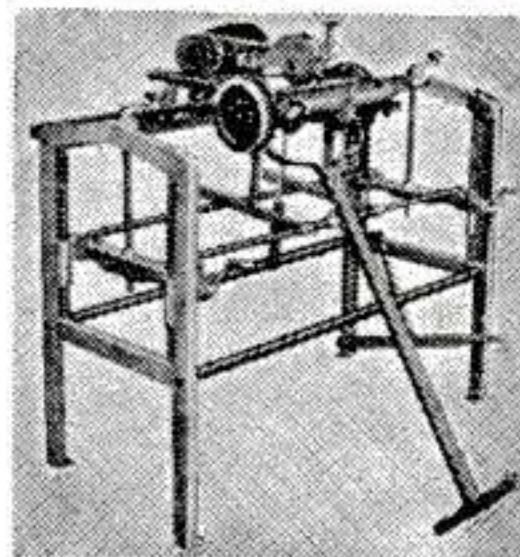

MASTER CHAMPION

LAWN MOWER SHARPENER
Also Mfg., Saw Sharpening & Key Machines

FRANK'S MFG. CO.

Dept. PS-12, 3312 Tweedy Bl. SOUTHGATE, CALIF., U.S.A.

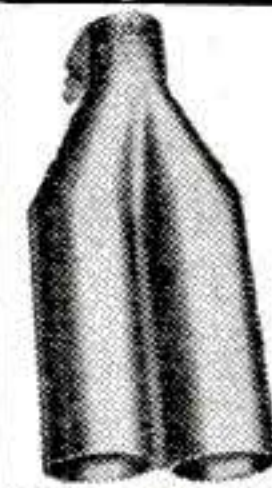

DUAL TAIL PIPE EXTENSION FOR YOUR CAR. **\$2.95**

DEEP TONE, PRODUCED BY 2 1/2 IN. OUTLETS

Chrome Plated - Fits All Cars

Postage Free on Money Order, Check or Cash

PAT. PEND. LYONS PRODUCTS Co. 2319 Ridgeley Dr. Los Angeles 16, Cal.

LEARN LANDSCAPING

Profitable, healthful career—absorbing hobby, for men, women. Thorough 45-lesson home-study course takes 8-12 months spare time. Hundreds of successful graduates all over the world. 31st year. Send for FREE catalog.

American Landscape School, 6474 Grand Ave., Des Moines, Iowa



A PENNY POSTCARD MAY CHANGE YOUR FUTURE...

Get full information on the coin-operated vending machine industry. Start with a few machines and build a wonderful future. We'll give you complete advantage of our "know-how." Send for Free Booklet Today—No Routes Sold!

PIONEER VENDING SERVICE

ADDRESS ALL MAIL TO DEPT. PS

461 SACKMAN ST. • BROOKLYN 12, N. Y.

AUDELS Carpenters and Builders Guides 4 vols. \$6

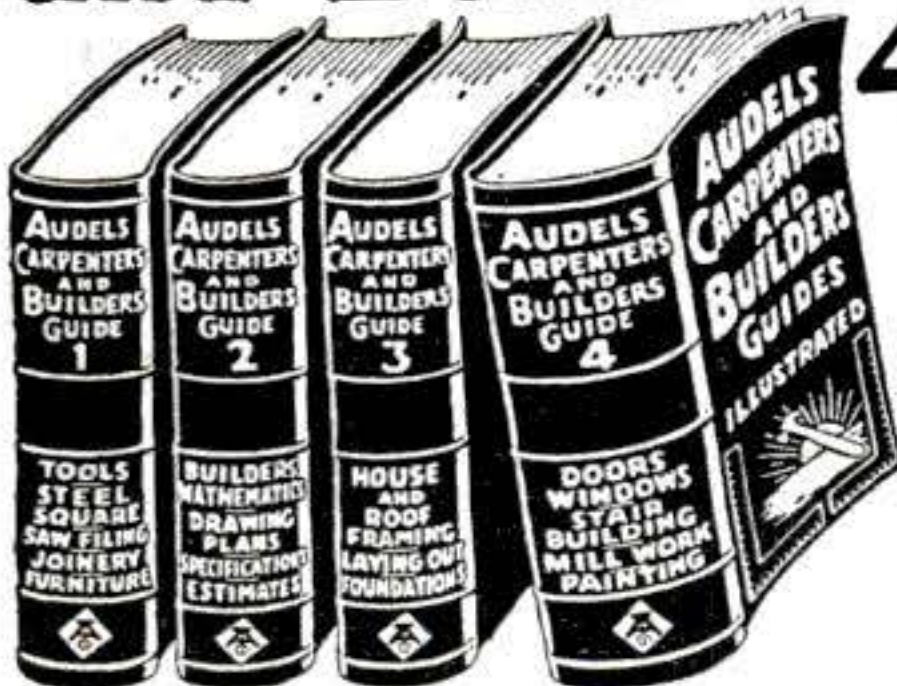

Inside Trade Information for Carpenters, Builders, Joiners, Building Mechanics and all Woodworkers. These Guides give you the short-cut instructions that you want—including new methods, ideas, solutions, plans, systems and money saving suggestions. An easy progressive course for the apprentice and student. A practical daily helper and Quick Reference for the master worker. Carpenters everywhere are using these Guides as a Helping Hand to Easier Work, Better Work and Better Pay. To get this assistance for yourself, simply fill in and mail the FREE COUPON below.

Inside Trade Information On:

How to use the steel square—How to file and set saws—How to build furniture—How to use a mitre box—How to use the chalk line—How to use rules and scales—How to make joints—Carpenters arithmetic—Solving mensuration problems—Estimating strength of timbers—How to set girders and sills—How to frame houses and roofs—How to estimate costs—How to build houses, barns, garages, bungalows, etc.—How to read and draw plans—Drawing up specifications—How to excavate—How to use settings 12, 13 and 17 on the steel square—How to build hoists and scaffolds—skylights—How to build stairs—How to put on interior trim—How to hang doors—How to lath—lay floors—How to paint



AUDEL, Publishers, 49 W. 23rd St., New York 10, N. Y.

Mail Audels Carpenters and Builders Guides, 4 vols., on 7 days free trial. If OK I will remit \$1 in 7 days and \$1 monthly until \$6 is paid. Otherwise I will return them. No obligation unless I am satisfied.

Name _____

Address _____

Occupation _____

Employed by _____ P. S. M.

LEARN TRIG QUICKLY—EASILY

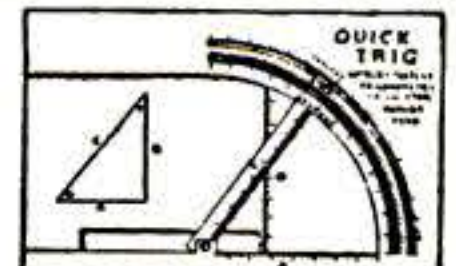

WITH QUICK TRIG, by competitive tests, it was found that QUICK TRIG gave answers faster to one with a slight knowledge of trig than to an expert on trig with a slide rule. Let it solve your trig. problems. You need no previous training. Entirely automatic. Easy instructions included FREE. We mail C.O.D. plus postage or send \$1.00, the full price, and we mail postpaid.

REED MFG. CO., 11350-H Burbank Blvd., N. Hollywood, Calif.



MECHANICAL DENTISTRY

A profession offering unlimited opportunities. Most modern and complete course embracing every branch from Plate to Porcelain Work, which prepares you to work for Dentists or start your own business. Individual instruction—practical training in day or night school. No books—no classes. Catalog upon request.

MCCARRIE SCHOOL OF MECHANICAL DENTISTRY
207 N. Broad St., Dept. 869, Philadelphia, Pa.

SIGNS EASILY AND EXPERTLY
AND **SHOWCARDS** PAINTED WITH LETTER PATTERNS
MANY SIZES & STYLES WRITE FOR FOLDER!
JOHN F. RAHN
1330-33 N. CENTRAL AVE.
CHICAGO 51, ILL.

WHICH OF THESE *Opportunities* INTERESTS *You* MOST?

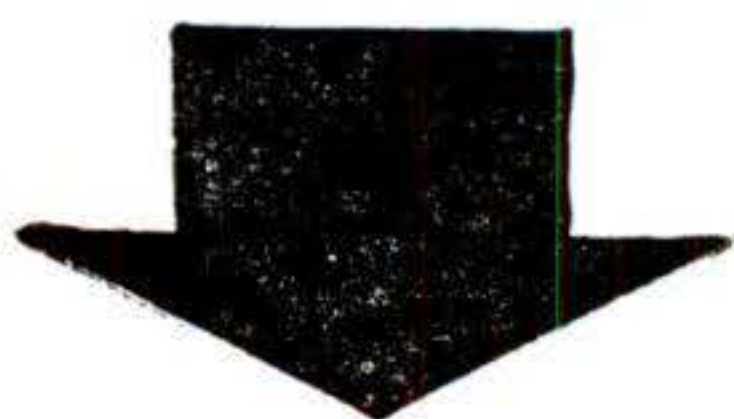

● *Today*, choose the job you want—and prepare for it. Or if you are already engaged in the work you like best, start training *now* for quicker promotion. Acquire the knowledge that will help you to get ahead faster, make more money and have greater security.

American School, founded in 1897 as an educational institution *not for profit*, can help you to reach your goal just as it has helped others during the past fifty years. Check the coupon at right, add your name and address and mail it at once. The school will send you details on its training plan and outline of study prepared by specialists. There is no charge, no obligation, so send the coupon immediately.

CHECK, CLIP AND MAIL COUPON NOW

AMERICAN SCHOOL, Dept. G946, Drexel at 58th, Chicago 37, Ill.
Without obligation, Please send FREE and postpaid, bulletin and details of the Subjects checked:

- | | | |
|--|---|--|
| <input type="checkbox"/> PLASTICS ENG'R | <input type="checkbox"/> Accounting | <input type="checkbox"/> Drafting and Design for Men and Women |
| <input type="checkbox"/> Refrigeration | <input type="checkbox"/> Electrical Engr. | <input type="checkbox"/> Radio |
| <input type="checkbox"/> Architecture and Building | <input type="checkbox"/> Electricity-Pract. | <input type="checkbox"/> High School |
| <input type="checkbox"/> Contracting | <input type="checkbox"/> Electronics, Industrial | <input type="checkbox"/> Air Conditioning |
| <input type="checkbox"/> Practical Plumbing | <input type="checkbox"/> Bookkeeping | <input type="checkbox"/> Mechanical Eng. |
| <input type="checkbox"/> Automotive Engr. | <input type="checkbox"/> Private Secretary | <input type="checkbox"/> Shop Management |
| <input type="checkbox"/> Aviation Drafting | <input type="checkbox"/> Diesel Engineering | <input type="checkbox"/> Tool Making |
| <input type="checkbox"/> Aviation | <input type="checkbox"/> Sheet Metal Pattern Drafting | <input type="checkbox"/> Better Foremanship |
| <input type="checkbox"/> Business Management | <input type="checkbox"/> Railway Training | <input type="checkbox"/> Machine Shop Operations |

Name.....Occupation.....
Address.....Age.....
City.....State.....

AMERICAN SCHOOL

Dept. G946, Drexel at 58th Street, Chicago 37



NOW Install your own LOW COST 2-WAY TELEPHONE

Talk from house to barn, warehouse office to shop, etc. Easy to use! Just hook up terminals to any 2-strand wire; several phones on same line if desired. Operates on standard flashlight batteries. Compact, rugged . . . portable. Performance equals best present day commercial telephones . . . GOOD UP TO 17 MILES!

NEW - per pair, complete with heavy canvas case . . . **\$29.50**; leather **\$32.50**. **USED - per pair** complete with either case.. **\$19.50**

Extra wire, new 500 ft. \$3.50. 1/2 mile reel \$10.50. 1-mile reel \$16.00. FOB Sacramento. No COD

Write for FREE Illustrated Catalog

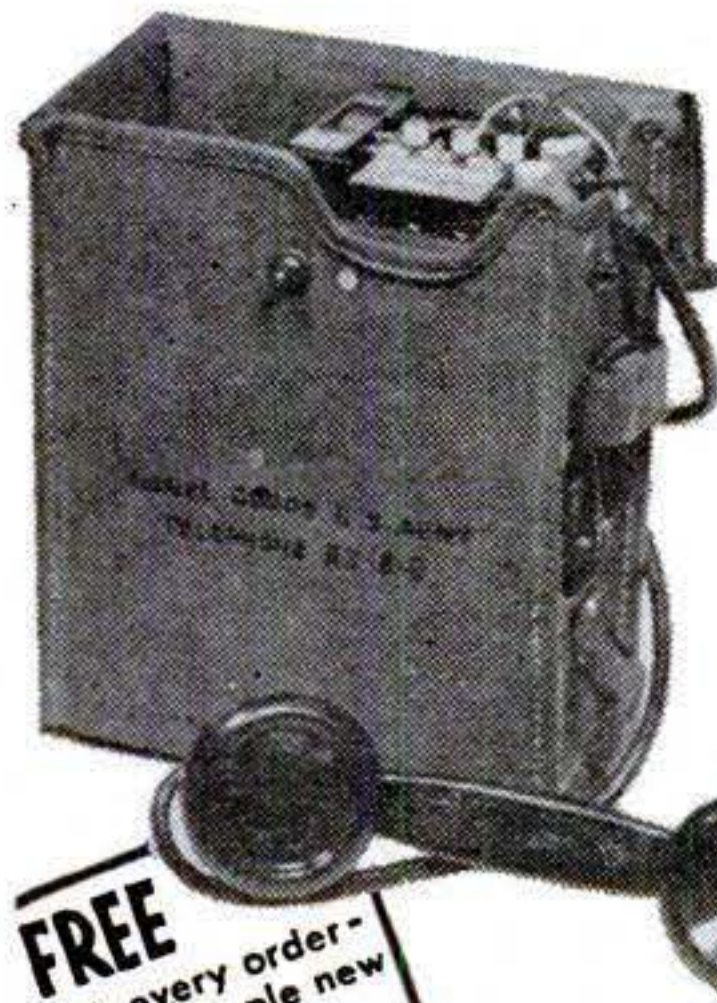

FREE With every order - 50 ft. sample new Army field wire.

MAKES IDEAL CHRISTMAS GIFT



SEND CHECK or MONEY ORDER **LORIS SALES**

P. O. Box 1896—Dept. A, Sacramento, California

HEATING with RADIANT HEAT PLUMBING AIR CONDITIONING REFRIGERATION

Here is the practical, low-cost help you need—to earn more—to make jobs easier—to save money on your own home up-keep. Thousands already in use. Select the help you need and order by number now, under money-back guarantee.

- 1. HEATING.** Cooling and Air Conditioning. New edition with big added section on Radiant Heat, new heating sensation. Use this book to hold the best jobs. Now 732 pages. 373 illustrations. **\$4.00.**
- 2. PLUMBING.** Installation and repair. Do your own work. 256 pages. 162 illus. **\$2.00.**
- 3. PIPING OFFSETS.** New book makes difficult offset piping jobs easy in all plumbing work. **\$1.50.**

Big Opportunities IN THE BIGGEST FIELDS OF ALL Help for Home Improvement Jobs!



- 4. REFRIGERATION.** Service Manual. Covers standard service, repair and maintenance work. 317 pages. 148 illus. **\$2.00.**
- 5. HOUSE WIRING.** Practical and up-to-date. Fine book for handy home owner. **\$1.50.**

Mail Coupon NOW FOR QUICK DELIVERY

Frederick J. Drake & Co., Dept. 59
600 W. Van Buren St., Chicago 7, Ill.
Send me books checked. If not satisfied I will return them in 5 days and money will be refunded.
() Check or Money Order enclosed \$.....Send books postpaid.
() Send C.O.D. plus postage.
Name.....
Address.....
City.....State.....
Drake's Books are Sold by Leading Booksellers

Learn this Profitable Profession



IN 90 DAYS AT HOME

Money-Making Career Open to Men and Women, 18 to 50

Hundreds of men and women between 18 and 50 make \$10 to \$20 in a single day giving scientific Swedish Massage and Hydro-Therapy treatments. There is big demand from doctors, hospitals, sanatoriums and clubs. Graduates earn large full time incomes from these or in private practice in their own offices. Others make good money from home treatments given in spare time. Learn this interesting, money-making profession in your own home, through our home study course. Same instructors as in our nationally known resident school. You can win independence and prepare for future security by qualifying for your Diploma. Course can be completed in 3 to 4 months. Many earn while they learn. Begin your training at once.



Anatomy Charts & Booklet FREE

Enroll now and we will include, at no extra cost, many needed supplies. Fit yourself to help meet growing demand for Scientific Swedish Massage. Send the coupon at once for complete details, Anatomy Charts and 32-Page Illustrated Booklet, FREE, postpaid.

THE COLLEGE OF SWEDISH MASSAGE

Dept. 770-R, 100 East Ohio St., Chicago 11, Illinois

Please send me FREE and postpaid, Anatomy Charts, 32-page Booklet and complete details on Home Training.

Name.....

Address.....

City..... State.....

LAW

STUDY AT HOME for PERSONAL SUCCESS and LARGER EARNINGS. 39 years expert instruction — over 108,000 students enrolled. LL.B. Degree awarded. All texts furnished. Easy payments. G.I. Approved. Send for FREE BOOK.

AMERICAN EXTENSION SCHOOL OF LAW
Dept. 84-S, 646 N. Michigan Ave., Chicago 11, Ill.

MASTER THE TRICKS of the NUMBER WIZARDS

At last it's been done! The exact methods used for centuries by mathematical wizards have been simplified and made to apply to present-day business problems. Think what this can mean to YOU. It means that now you can use these amazing high-speed methods in your own work; you can make them the key to sure advancement and real success.

"HIGH-SPEED MATHEMATICS" by LESTER MEYERS

This great, brand-new book will show you how to handle figures swiftly and accurately; how to compute mentally; how to solve thousands of different business problems without making a single mistake. Best of all, **nothing more than a knowledge of simple arithmetic** is necessary to understand and apply the practical methods explained and made crystal-clear by Mr. Meyers.

EXAMINE IT FREE

Devote as little time as twenty minutes each day to this new kind of book and you will be amazed at how quickly you will acquire a feeling of complete confidence in the speed and accuracy of your work—the kind of confidence that leads to promotions, to bigger and better jobs and to higher pay. Mail the coupon below.

D. VAN NOSTRAND COMPANY, Inc., Pop. Sci.—Dec. '47
250 Fourth Avenue, New York 3, N. Y.

Please send me a copy of "High-Speed Mathematics." Within 10 days I will either return the book, or send you \$1.95, plus postage, as a down payment, and \$2.00 a month for two months until the total price of \$5.95, plus postage, is paid.

NAME.....

ADDRESS.....

CITY..... ZONE..... STATE.....

Have an OFFICE of YOUR OWN!

LEARN NEW PROFITABLE PROFESSION At Home in 60 Days, Men & Women, 18 to 70!

Be Your Own Boss and the Boss of Others. Be Respected. Meet Interesting People.

Earnings of men and women in this profession run as high as \$5,000-\$15,000 yearly. Others make good money in spare time. Little money needed to start. A business where your earnings begin sooner. Easy to learn. No selling or goods to buy. No experience necessary. A depression-proof business. A course of action to guide you step by step as you earn. All 53 lessons sent at once to use as operating manuals. Easy terms. Diploma. Money-back agreement. Write for FREE BULLETIN.

FRANKLIN CREDIT SCHOOL
Dept. 71-N ROANOKE 7, VIRGINIA



BY MAIL in Easy Lessons

The American Institute of Specialized Watch Repair
270-276 East Building GRAND RAPIDS 6, MICHIGAN

A Fully Accredited School

You can learn this highly fascinating and profitable trade through this Institute, either at home by correspondence... or at the resident school.
Earn While You Learn



Write for Free Circular

Learn WATCH REPAIRING

Raise GOLDEN HAMSTERS

The new wonder animals from Syria. Look like Toy Red Bears. Delightful pets. Everybody wants them. Thousands needed by laboratories. Make money. get started now. Write for free information, or send \$5 for a pair of hamsters and full instructions.



GULF HAMSTERY 1540 BASIL ST., MOBILE 17, ALA.

INVENTING

—FOR PROFIT!

If you have an inventive turn of mind, write for free 28-page booklet explaining how the Institute of American Inventors is helping inventors pre-test the profit possibilities of proposed devices to fill today's unprecedented demand for new inventions.

INSTITUTE OF AMERICAN INVENTORS
Dept. 3, 1926 Eye St. NW, Washington 6, D. C.

PATENTS AND TRADE MARKS

P. C. A. SNOW & CO.

REGISTERED PATENT ATTORNEYS

WRITE FOR INFORMATION TO
426 SNOW BUILDING, WASHINGTON 1, D. C.

INVENTORS

The question as to whether a subject matter is patentable can be substantially determined by a search of the U. S. Patent records. Without obligation, write us for

Full information on what steps an inventor should take to secure a Patent.

RANDOLPH & BEAVERS

Registered Patent Attorneys

905-L Columbian Building, Washington 1, D. C.

INVENTORS

IF YOU WISH TO PROTECT YOUR INVENTION, You should take steps to protect it by a U. S. Patent. Write me for "Record of Invention" form.

CARL MILLER REGISTERED PATENT ATTORNEY

Woolworth Bldg., 35th Floor, Dept. 127-C, New York City
Please send me "Record of Invention" form.

NAME.....

ADDRESS.....



THE UNIVERSAL LIQUID CEMENT
The "Mr. Fix-it" for "a million things"

Tops in quality for 37 years. Uses unlimited . . . sticks and mends permanently. Waterproof . . . quick drying. Keep a tube on hand always. Extra quality . . . extra strength. Ready to use. **LOOK!** Get acquainted with Ambroid quality. At your dealers or send 25c for big 2-oz. tube postpaid (U.S.A. only). Money back guarantee. **25¢**

AMBROID CO.
 307 Franklin St., Boston 10, Mass.

Also 50c 4-oz. tube. Pts., qts., gals. for industrial use.

LEARN TO WRITE
a Good Hand!

FOR BUSINESS AND SOCIAL SUCCESS!

Improve your handwriting at home quickly with my new instruction books just off the press. Master all the secrets of better penmanship. Simple and easy, fully illustrated, highly endorsed. Begin today. Write for: **Free Book**, "How to Become a Good Penman", or check books wanted, \$1.00 each. Business Writing Artistic Writing Card Writing Engrossing Alphabets Bird and Design Flourishing Complete Set \$4.50 Enclose 10c for your name beautifully written and shading penpoint.

S. A. Ziller, President, TAMBLYN SCHOOL OF PENMANSHIP
 439 Ridge Bldg. In Business Over 52 Years Kansas City, Mo., U.S.A.

ANALYZE Handwriting

Uncrowded, fascinating field. Gratifying earnings reported by graduates in Employment, Credit, Social Service, Police and Entertainment fields. Others have developed profitable private practice, full or spare time, as Personal Problem and Vocational Counselors. Send for 3000 word TEST LESSON and Grapho Analyst FREE.

A. I. G. A. Inc., Wilholt Bldg., Dept. 126, Springfield, Mo.



HOW TO CUT RAFTERS

New vest pocket book gives lengths, Side cuts, Plumb cuts, Deductions. For all rafters for any building from one inch to forty feet wide. Gives numbers to cut on square. Also degrees for same cuts for Radial Saws. All standard pitches from 1/8 to 3/8. Just open book to pitch page and there are your lengths, side cuts, etc. Anyone who knows what a jack rafter is can frame a roof if he has this great book. Price one dollar prepaid. Builders' Topics, Dept. S, Lock Box 828, Seattle, Washington. Original teachers of the square in five easy lessons by mail. SEND FOR FREE LIST OF TECHNICAL BOOKS. Learn to read blueprints, etc.

ARTISTS MAKE MONEY

Do you like to draw? Send name, address, age and occupation for FREE ART TEST, to find out your ability.

ART INSTRUCTION, INC.
 12147 Art Instruction Bldg., Minneapolis 15, Minn.



WOULD you like to buy yourself a nice big chunk of financial security? You can by building a lucrative business of your own NOW with TRADIO, the radio functionally-designed for coin-operation in hotels, hospitals, motels, etc. All over the country, individuals like yourself are finding it a natural for big earnings and a steady income. TRADIO has pioneered in this new and flourishing postwar industry. Get in on the ground floor and assure yourself of financial security for life.

Phone, wire or write Dept. O-12 for complete information. No routes sold.

TRADIO, Inc. ASBURY PARK NEW JERSEY

The Importance of Choosing a Long Established Technical Institute

Of utmost importance to anyone considering entering a technical institute, is that organization's history — also its facilities, faculty, and record of successful alumni. The Milwaukee School of Engineering, for 44 years has been training men for specific and substantial careers in industry. More than 35,000 former students now in industries the world over attest the career-building value of the Milwaukee School of Engineering, through its exceptional facilities in buildings, shops, laboratories, classrooms — and the comprehensive, practical technical courses under the supervision of its faculty of 72 specialists.

SPECIALIZE IN 6 MONTHS TO 3 YEARS

- COURSES**
- SERVICE**
 6 to 12 Months
- Electricity
 - Welding
 - Refrigeration
 - Heating
- TECHNICIAN**
 1 to 2 Years
- Electricity
 - Radio
 - Electronics
 - Refrigeration, Heating and Air Conditioning
- PROFESSIONAL**
 3 Years
- Electrical Engineering Bachelor of Science Degree
 - Major in Machinery or Electronics

Our time-tested CONCENTRIC SYSTEM enables you to build your career step by step. Each 6-month course is complete in itself, yet prepares you for advanced courses. You train as long as circumstances permit — until you reach the "top step" in your desired occupational objective. 1,538 students now enrolled from 48 states and 13 overseas countries.

Terms Start January, April, July

MILWAUKEE SCHOOL of ENGINEERING
 A Technical Institute

MAIL COUPON TODAY!

Milwaukee School of Engineering, Dept. PS-1247
 N. Broadway and E. State, Milwaukee, Wisconsin

Without obligation, send me free booklet "Career Building" and more details on course in.....

Name Age

Address

City State

Learn to Repair ELECTRIC APPLIANCES

**AT
HOME
in your
SPARE
TIME**



**WRITE
TODAY
for
FREE
BOOK**

Prepare now for a permanent future, independence and security with a business of your own. Our practical, easy-to-learn home course teaches you, during your spare time, how to repair washing machines, vacuum cleaners, electric ranges, lamps, motors, irons, etc., REFRIGERATION and HOUSE WIRING.

OPEN YOUR OWN SHOP

For the man who is handy with tools, and likes to work with his hands as well as his head, there is a WIDE OPEN OPPORTUNITY today, in this great growing field. If you own your own shop you can depend on making more money in good times . . . and not losing your job in a depression. You can start a business of your own in your garage or basement with the tools we send you. One good repair job can pay for the cost of the entire course. Write today for our FREE BOOKLET.

**I Send
You a
BIG KIT
of Special
TOOLS
at NO
EXTRA
COST!**

PACIFIC TRAINING SCHOOL

7217 So. Broadway, Dept. S-112, Los Angeles 3, Calif.

Dear Sirs: Please send me, without obligation, your free booklet and complete details.

Name

Address

City..... State.....



LAWN ORNAMENT-NOVELTY PATTERNS

28 Lawn Ornament Patterns, 25c. Other patterns: 15-20" high; Dutch Girl, Dutch Boy, Pirate, Bull Terrier, Mexican Girl, Mexican Boy, Dwarf, Penguin, Flower Girl, 10c each. 25 Novelty Patterns, 30c. All 62 Full Size Patterns, \$1.00 Postpaid. Strother Pattern Service, Dept. 7-Y, Box 383, Belington, W. Va.

THIS FREE BOOK

*Tells how we
can teach you
QUICKLY & EASILY*



TO MOUNT BIRDS AND ANIMALS

GAME HEADS, FISH
Send at once for this fascinating free book which tells how you can learn to be a taxidermy artist. Save and preserve your beautiful hunting trophies. Decorate your den. A grand hobby for sportsmen, hunters, anglers — both men and boys! **DOUBLE your fun from hunting and fishing.** We teach you this marvelous art right in your own home, by mail, in your spare time. Also, we teach you to make strong, useful **GENUINE LEATHER** from hides. **Act RIGHT NOW. SEND TODAY!** Rush a letter or penny postcard for the beautifully illustrated 68-page **FREE BOOK.** Full of fascinating game pictures. Learn about this old reliable school for outdoorsmen. 43 years in business. More than 400,000 students. No cost or obligation for the book. **BE SURE TO STATE YOUR AGE!**

NORTHWESTERN SCHOOL OF TAXIDERMISTRY
3399 Elwood Building - OMAHA 2, NEBRASKA



Be A MASTER PLUMBER

Earn \$15 To \$50 A Day

DON'T ENVY THE PLUMBER—BE ONE

Every skilled workman will tell you that Plumbers have the best of it. WINTER and SUMMER the Plumber is busy at top wages. No skilled Plumber is ever out of a job—compare his opportunities with any trade, plus the opportunities of having your own shop. We teach you Plumbing with TOOLS (not books) under Licensed Master PLUMBERS in one of the finest equipped schools in America. We make you a Plumber, every branch is taught thoroughly—Lead Work—Blueprint for plan reading—all other tricks.

LEARN IN 30 WEEKS WITHOUT PREVIOUS EXPERIENCE

If you like to work with tools you owe it to yourself to investigate. No need to ever work as an apprentice. Get free bulletin. Write now! G.I. APPROVED. Our 24th year.

UNIVERSAL PLUMBING SCHOOL
819 HOLMES STREET KANSAS CITY, MO.

BATTERIES!—START

—a factory at home and re-cast junk batteries into new; latest achievement. We supply complete instructions and everything needed. Big Profits! BATTERY LABORATORIES, Dept. PS, Minneapolis 4, Minn.



DENTAL TECHNICIANS

Nationwide openings for trained men. Learn by simple home study — with theory and actual practice as a guide. EASY STEP-BY-STEP TECHNIQUE

for information
write to DEPT. PS-1

DENTAL ARTS INSTITUTE

1122 MARKET STREET, SAN FRANCISCO 2, CALIF.

INCREASE YOUR INCOME

200 Business of Your Own Plans. Plan No. 4. This one is extra good now. 5. A lifetime income. 6. Back yard pays \$40.00 a week. 8. Start this anywhere. 9. Make professional's salary. 11. \$18,000 from old paper. 12. Three extra profit plans. 14. Big extra income from garden specialty. 15. \$15.00 to \$25.00 a day made. 16. Steady income plan. 21. Twice regular wages. 25. Fortunes have been made with this. 33. Start small. Great future. 43. This can pay a man \$100.00 a week. 46. A fine repeat business. 47. Always a living. 50. Tractor, year around income. 51. \$25.00 a day, little work. 52. Has gone over big. 64. Immense possibilities. 65. Work every day plan. 74. Earn your way anywhere. 79. Fortunes from junk. 87. An independent living. 96. Fine for ex-service man. 97. Big profit from back yard. 100. Exceptional for the young man. All 200 plans for \$1.00 postpaid. HOME INDUSTRIES, 1318 So. 30th Ave., Dept. P. S., Omaha 5, Nebr.

WANTED—Ambitious Men

who would like to go to this famous school. Stream-lined courses in Diesel, Diesel Electric, Electricity, Radio Mechanics, Refrigeration. Air-Conditioning. Write for FREE catalog.

BAILEY TECHNICAL SCHOOLS
1653 So. Grand Blvd. St. Louis, Mo.

New Designs in FRANZITE GRIPS

Modernize Your Gun! Improve Your Score!
Most durable grips made. Positively unbreakable! For Colt, Smith & Wesson, Hi-Standard, Ortgies, Luger & Mausers in a wide choice of beautiful designs in ivory, pearl, walnut, onyx, etc. Low prices. **FREE CATALOG.** Dealers Wanted.
SPORTS, INC., (Mfrs.) 5501 Broadway, Dept. S-12, Chicago 40, Ill.



Say You Saw
It In Popular Science

EYE GLASSES BY MAIL

FREE ... of extra charge: Eye Glass Case, Wiper, Eye Glass Cleaner with Each Order!
• 30-DAY TRIAL OFFER
NEWEST STYLES. Write today for **FREE** Catalog, Full Information, Low Prices, Scientific Sight Test Chart!
LEE EYE GLASSES CO.
4148 Easton, Dept. Q-3, St. Louis 13, Missouri



SEND NO MONEY
LOW AS \$1.95 AND UP
POSITIVE MONEY-BACK GUARANTEE



"JACKPOT"

Home Model COIN MACHINE

Great fun-maker for recreation room or club. Soon pays for itself. Fully automatic payout, three reels, with all the usual winning combinations . . . cherries, lemons, plums, etc. Double jackpot. Set for 60% payout to the player, 40% profit for the house. Guaranteed to satisfy or money back. Rugged lifetime construction. Ht. 18 1/2 in. Takes space only 14 1/2 x 11 1/2 in. CHOICE OF 1c, 5c, 10c, or 25c PLAY. Shpg. wt. 47 lbs. Send \$10.00 deposit, balance C.O.D. Express F.O.B. Chicago.

Immediate delivery Each, **\$198.00**
Write for FREE DESCRIPTIVE FOLDER

Webb DISTRIBUTING CO. INC.

6 SOUTH KEDZIE AVE. • CHICAGO 12, ILLINOIS

Are You Getting Our Flyers???

If not, PRINT your name and address on a penny postcard. It will mean dollars in the bank for you!!! Ask for our latest catalog and flyer. Dept. PS.

RADIO EQUIPMENT CO.

377 E. Main St. Lexington, Kentucky

"Your friendly parts house"

NEW! MINIATURE DUST MASK

Wear when sanding, grinding, paint spraying, sweeping, dusting, furnace cleaning, etc. Handy as a pair of glasses. Just keep mouth closed and breathe through nose is all you do to operate. Protects against nuisance dusts, lint, coal, cement, grain dust, Hay Fever Pollen. Has 9 sq. in. filter.

For EYE protection against paint spray, dusts, gases, fumes, smoke, order our Fog-Proof Rubber GOGGLES. \$2.00 p.p.

JERRY BRYANT, Dept. PS, 919 N. Michigan Ave., Chicago 11, Ill.



Order Today \$1.00 POST PAID

Let BLEECKER START YOU in a BIG PAY BUSINESS!

Sensational Selling Outfit Furnished

Here's the moneymaking opportunity of a lifetime! Chance to get into your own big paying business with the world's fastest selling line of home and farm necessities. High quality startling, low, money-saving prices. Sensational bargain deals to win quick, permanent customers. Special offer for limited time to fill quota of new dealers. Write to learn how you can get valuable sales outfit of big, fast-selling line without paying one cent extra. If you act quickly.



THE BLEECKER CO. Dept. S-127 Farmington, Minn.

Big New Novelty Catalog Now Ready!

500 Pages; 6000 Amazing Novelties

Send 10c today for this mammoth, amazing new catalog of over 6,000 novelties. More fascinating than a World's Fair. Thousands of things you never knew existed—never knew where to get. Includes novelties, tricks, jokes, live animals and pets, scientific supplies, den novelties, hobby supplies, planes and boats, looms, magic, unusual seeds, gadget time savers, cameras and optical goods, movies, projectors, lucky jewelry, religious novelties, telegraph sets, magnets, disguises, easy musical instruments, stamps, coins, puzzles, fortune tellers, occult and supernatural, radios, experimental sets, auto & bike accessories, Western belts and wearing apparel, telescopes, magnifiers, compasses, banks, smokers' gadgets, artists' supplies, printing sets, engines and motors, electric shockers, knives, billfolds, fireworks, guns and rifles, weird articles, archery, swimming helps, 1000 fascinating books, games, locks, live chameleons, rings, watches, charms, barometers, fireworks, imported novelties, exercisers, money savers, handy tools, Indian novelties, etc., etc., etc. Jammed and packed with sensational funmakers and useful articles. Big catalog—over 1 inch thick, 6 color cover. (DeLuxe Hard Bound Library Edition 25c Postpaid). Regular paper covered edition, 10c. Send today!

JOHNSON SMITH & CO., Dept. S-5, Detroit 7, Mich.

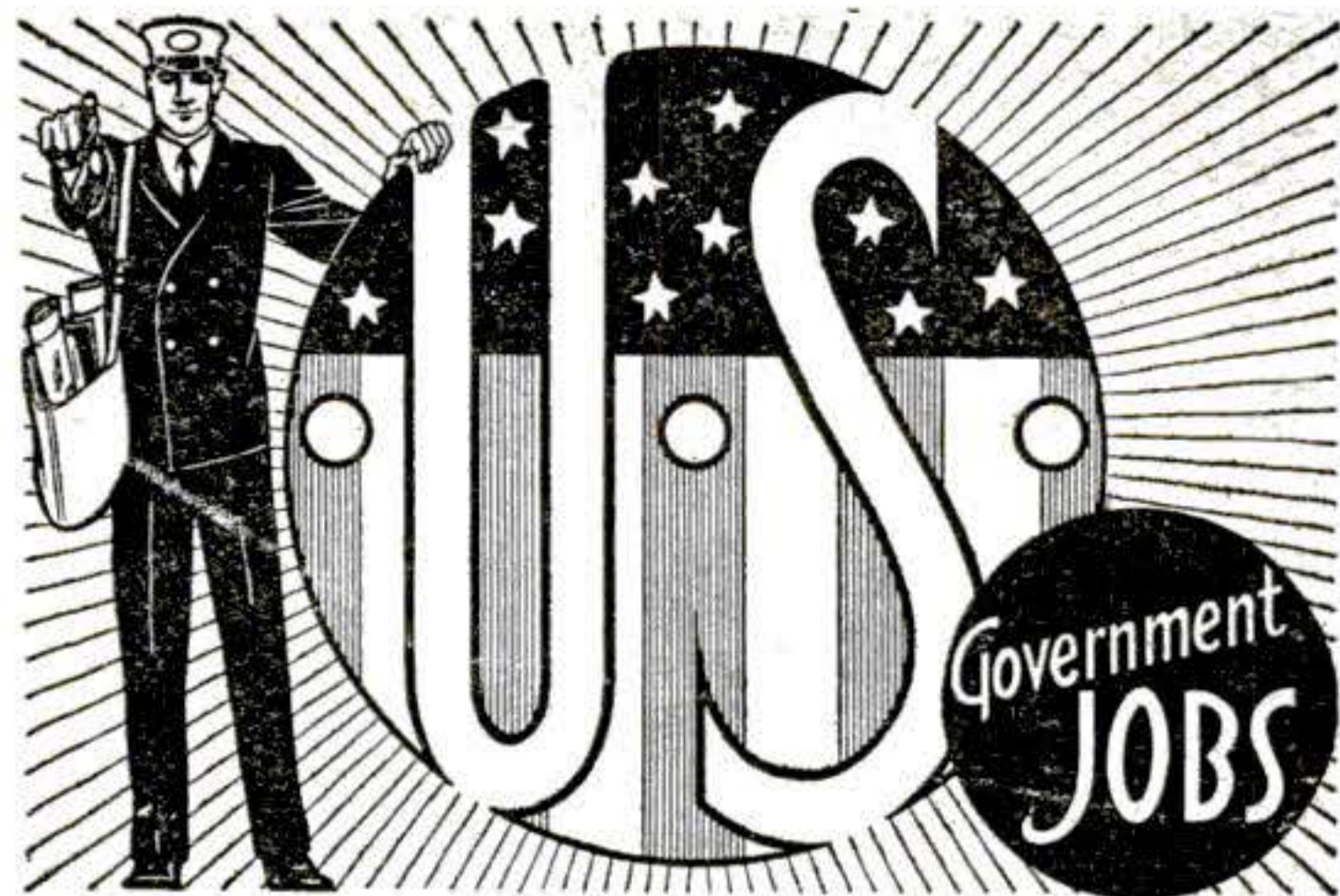

Start \$1,756 to \$3,021 a Year

Get Ready Now for 1948 Examinations in Your Section

Veterans Get Preference

Railway Postal Clerks

Railway Postal Clerks get \$2,300 the first year regular, being paid on the first and fifteenth of each month. (\$95.70 each pay day.) Their pay is automatically increased yearly to \$3,400. Advance may be had to Chief Clerk at \$5,400 a year. (\$225.00 each pay day.)

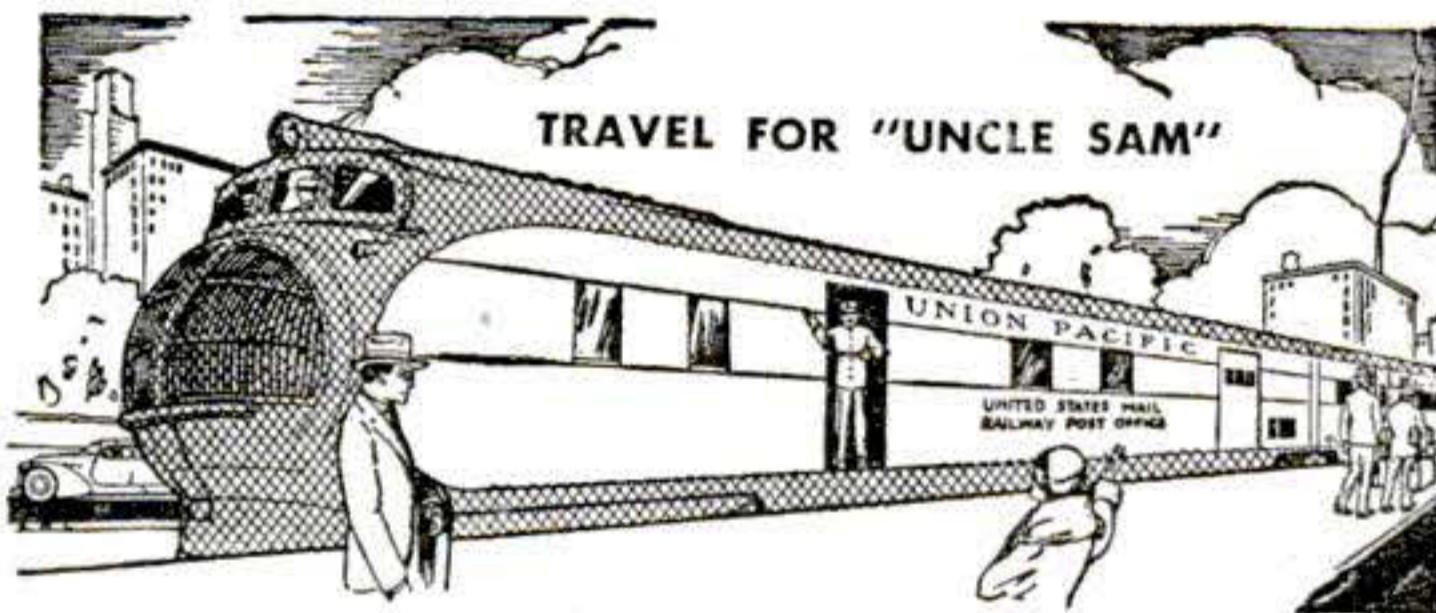

3 Days On—3 Days Off—Full Pay

Railway Postal Clerks on long runs usually work 3 days and have 3 days off duty or in the same proportion. During this off duty their pay continues just as though they were working. They travel on a pass when on business. When they grow old, they are retired on a pension.

City Mail Carriers, Post Office Clerks

Clerks and Carriers now get \$2,100 the first year on regular and automatically increase \$100 a year to \$3,100. Open to men-women 18 to 50.

GOVERNMENT CLERK



Many Other Positions

Many other positions are obtainable. Rural Carriers—Stenographers — Typists — Assistant Statistical Clerks — Customs Inspectors — Office Machine Operators—etc. Those wishing these positions should qualify at once.

Get Free List of Positions

Fill out the following coupon. Tear it off and mail it today—NOW, at once.

This investment can help you to get a big-paid government job.

FRANKLIN INSTITUTE, Dept. R-80, Rochester 4, N. Y.

Rush to me, entirely free of charge (1) a full description of U. S. Government Jobs; (2) Free copy of illustrated 32-page book, "How To Get A U. S. Government Job"; (3) List of U. S. Government Jobs; (4) Tell me what to do to prepare for one of these jobs.

Name.....

Address..... Vet?.....

Use This Coupon Before You Mislaid It. Write or Print Plainly.

RHEUMATIC PAINS?

take this sufferer's advice
Mr. I. K., Wilmington, Del., advises everyone suffering from pains of Rheumatism, Arthritis, Sciatica to **try RUMAL**

"Mr. I. K. of Wilmington, Delaware, writes: For years I have suffered with agonizing pains of Rheumatism. Nothing seemed to help much. Then a friend of mine suggested that I try a preparation called RUMAL. I was skeptical but I had nothing to lose so I sent for a jar. I tried it and am happy to say that I got relief from the very first application. It's a God-send to have RUMAL in the house for when those awful pains strike, I'm prepared."

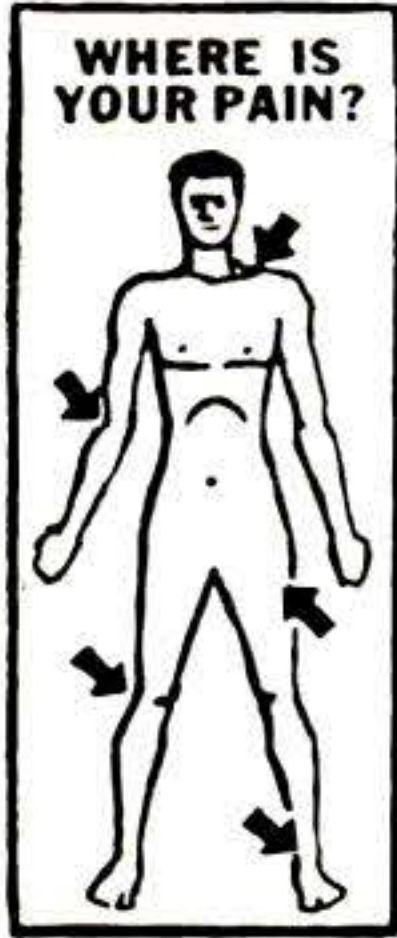

I don't care how long you have been suffering the agonies of RHEUMATIC, ARTHRITIC SCIATIC, NEURALGIC PAINS—I want you to try a remedy that is really good.

It MUST be good, for it has been bringing blessed palliative relief to thousands of sufferers since 1919—over 26 years.

And the best part is that you don't risk one penny in trying RUMAL—you CAN'T lose—only gain by doing it.

RUMAL is a compound of 5 powerful ingredients widely known to the medical profession as fast pain relievers.

You apply RUMAL as directed to the painful area. Soon you feel a glowing, soothing warmth as the pains disappear FAST.

SEND NO MONEY NOW for RUMAL. Just mail name and address—now. When postman delivers package pay him only \$2 plus post-

age and C.O.D. charges. If you prefer, enclose \$2 and we pay all postal charges. **GUARANTEE:** If after using 1 jar of RUMAL you don't feel that it has helped you, you get your money back.

RUMAL MEDICINAL PRODUCTS
 206 Division St., Dept. 32, New York 2, N. Y.

FIREWORKS!

CHINESE FIRE CRACKERS

Immediate Delivery

- 80/16—1½ Jolly Brand\$4.50 per bundle
- 80/20—1½ Jolly Brand 5.35 per bundle
- 80/16—1⅝ Cock Brand 5.50 per bundle
- 80/20—1⅝ Cock Brand 6.50 per bundle

SMOKE BOMBS Per Case of 25 **\$10.00**

TERMS CASH WITH ORDER

UNITED FIREWORKS MFG. CO., INC.
 DAYTON 7, OHIO

Now CHEAP OIL BURNER
 FOR HEATING AND COOKING STOVES-FURNACES
 HEAT YOUR HOME, COOK YOUR MEALS
 WITH CHEAP FURNACE OIL

NO MORE SHOVELING COAL OR ASHES. Sensational Fuelizer Starter Vaporizing System turns Cheap No. 1 Furnace Oil, also Range, Heater, Tractor Distillate, Kerosene and like oils into oil heat—one of the quickest, hottest fires known. **LIFETIME GUARANTEE. \$1.00 Bonus Offer for Testing.**

We will let you try it in your own stove or furnace for one month. Get yours for introducing. Big profits QUICK. Be first. Send in your name today for details and cash in on the tremendous demand for this Amazing Invention.

NORTHWEST MFG. CO., 606-P, Mitchell, S. Dak.

MAKE UP TO \$1000.00 A MONTH

Own Your Own Business Now!

Make more money the modern way. Send for **FREE** bulletin No. 11A for details on the Modern Lawn Mower Sharpener.

MODERN MANUFACTURING COMPANY
 160 N. FAIR OAKS, PASADENA, CAL.

OTTAWA TRACTOR SAW

350 Cuts Per Minute--cuts them down, saws them up, one man operates. Thousands in use, stiff heavy blade, built to last, safety clutch control, uses power take-off any tractor. Low price.

OTTAWA MFG. CO., 2-701 Forest Avenue, OTTAWA, KANSAS

A TIP FOR THE HOME WORKSHOP

Keep micrometers factory-new, tools keen-cutting, motors and pulleys supple, with

FIENDOIL 3 oz. spout can 40c

FOR HOME • SHOP • SPORTS

MONEY for MEN ALL DATA FREE

THE PLASTEX Industry needs manufacturers on small scale and for big production of Lamp and Clock Stands. Art Goods and Novelties in Plastex and Marble imitation. Experience unnecessary. ½c material makes regular 10c store sellers. Rubber moulds furnished for speed production. Small investment brings good returns. Big chain store orders now being placed. Ambitious men have chance for real prosperity. Our Free booklet will interest and benefit you.

PLASTEX INDUSTRIES, Dept. 2, 3400 Third Ave., New York 56, N. Y.

Order Now for Christmas

(Leave adv. exposed to Santa)

Mows and Trims Lawns

In One Simple Easy Operation 8¼ Lbs.

Save Time and Labor with a MONTAMOWER

New model. New type metal handle has device to adjust cutting height. Drive shaft mounted on free rolling, factory lubricated, sealed ball bearings. No tired backs or aching arms. 8¼ lbs. of live precision mechanism that first gathers, then cuts smoothly a clean 16" swath through grass, dandelions, spike grass and weeds. No noise or clatter. As modern and efficient as your electric razor. Cuts right up to walls, fences, trees or posts; leaves no fringes to be trimmed by hand. Cutters are self-sharpening. Built to last many years. Many thousands in use. Sold direct from factory for 25 years. Costs little. Don't risk late delivery in rush Spring season. **ORDERING NOW GUARANTEES** choice of immediate, pre-Christmas or early Spring delivery. Write at once for "TRIAL ON YOUR OWN LAWN" approval offer, guarantee information and literature.

MONTAMOWER DISTRIBUTING CO.
 830 Keeler Bldg. GRAND RAPIDS 2, MICHIGAN

**IS YOUR CAR
CRAWLING LIKE
A TURTLE?**



If your car is listless . . . has no pep and power . . . do as race drivers do—install a set of quick-seating Burd "Graf-Flox" Piston Rings. You'll save on gas and oil, too!

Send today for free, handy booklets for car-owners. Write name and address in margin, clip and mail ad today.

BURD PISTON RING CO., DEPT. PS, ROCKFORD, ILL.

GARDEN TRACTORS

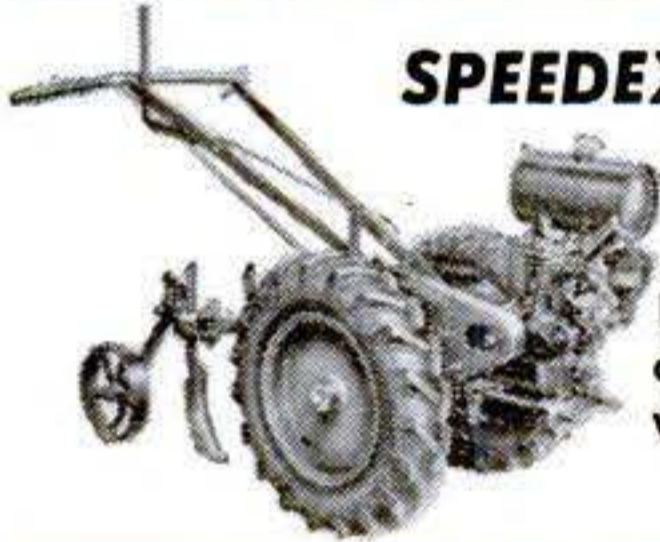

SPEEDEX

**SAVE UP TO
\$100.00 OR MORE
BY PURCHASING NOW**

Immediate delivery in limited quantities. For full information write for free circular.

P-1247-53

**POND GARDEN TRACTOR COMPANY
BOX 216 RAVENNA, OHIO**

for AMAZING acceleration

DIXIE-WESTERN
DUAL INTAKE MANIFOLDS for
V-8 FORDS AND MERCURYS

\$1500 Gas Line and Throttle Kit \$2.50 extra

Chrome Plated Velocity Stocks — \$1.50 ea
By Test: Increased Acceleration by 26%
Increased Power and Speed by 11%

All DIXIE-WESTERN manifolds are brightly polished cast aluminum.

DIXIE-WESTERN MANIFOLD CO.
Box 364 • Los Angeles 43, California

Dual Intake Manifolds
Dealers Wanted

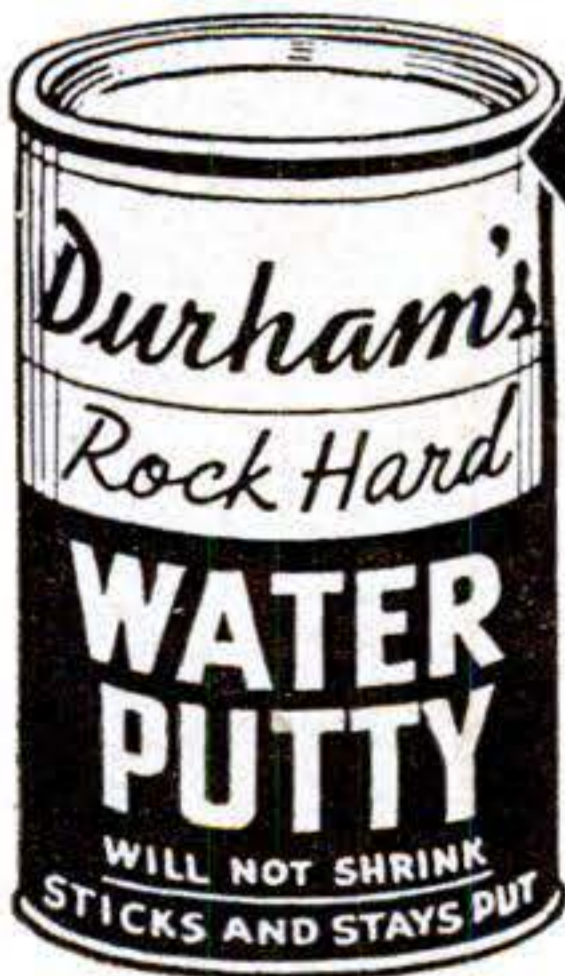

**The Modern PLASTIC
for lasting Home Repairs**

PERMANENTLY mends cracks or holes in wood, tile, stone or plaster. Sticks and stays put—Does not chip, shrink or fall out. Easy to use. Economical. Mold it, chisel it, polish or paint it. If unobtainable from your lumber, paint or hardware dealer, the big 4-lb. can will be sent you post-paid (in U.S.) for only \$1. Full money-back guarantee, order now.

DONALD DURHAM CO.
Box 804-L, Des Moines, Iowa

**Don't Wait for Success to Come to You
Go After it Now and be Sure of Your Future**

**Enjoy the Best Opportunities
in the Big Opportunity Field
GET STARTED Quick
in DRAFTING**

**I Will Train You at Home Until
You Have a GOOD
PAY
JOB**



Engineer Dobe

Take the first step now and step into Drafting—with the best opportunities in the big opportunity fields—as an experienced, well paid draftsman. Act now for a better job, better pay and better working conditions.

**Drawing Tools and
Working Outfit
Included**



All drafting instruments and table and other needed equipment sent when you start. Nothing for you to buy. You start right out on real drafting jobs using real professional equipment.

**Industrial Design
Training Included**

Some of the best paying jobs are in Industrial Design work, so I give you a complete extra course in this fascinating, profitable work. This is an Engineer Dobe extra and will cost you nothing.

Thousands of Opportunities

The field for draftsmen is bigger than ever before—and growing all the time for all new products, appliances, machines and construction must start with the draftsman. No invention—no development—can ever take the draftsman's place. He is a key man in every industry.

Learn From an Engineer

Get into drafting now. Learn from an engineer who has trained thousands of successful men. I will give you that same training at home in your spare time, give you actual work—the same kind of jobs you will do with the best paying firms. I will train you until you are competent, fully experienced, and holding a position that will bring advancement and pay raises.

Experience as You Learn

Your training will be experience because I give you practical jobs to do. And I list your experience and send it to employers as a reference when you are ready. All Dobe trained men start out with experience. You will too, because I will train you until you get a good job in drafting.

ACT NOW!

Take the first step now. Mail the coupon below so I can send you all the facts. Give age to get reply.

Mail Coupon for VITAL FACTS!

Engineer Dobe, Div. 20 Libertyville, Ill.

Send me the Vital Facts on Drafting and Industrial Designing, your FREE BOOK and advertised list of positions for Draftsmen and Designers wanted.

Name.....Age.....
Address.....
City.....Zone.....State.....



NORTHLANDS

As you zoom away on Northlands feel confident that Northland craftsmanship has given you the world's finest skis—first step toward better skiing. Send 15c for Northland Ski Manual edited by H. Schneider. Or write for Free Booklet.

NORTHLAND SKI MFG. CO.

World's Largest Ski Manufacturers

94 MERRIAM PARK • SAINT PAUL 4, MINNESOTA



WORLD'S SMALLEST RADIO KNOWN!

Wt. only 1/4 lb. Beautiful Silver Black plastic case. Has Inductive Slide Tuner—W4 Crystal Diode—NO TUBES, BATTERIES OR ELECTRIC "PLUG IN" NEEDED!

GUARANTEED TO PLAY • NEW 1948 MODEL

on local stations if complete instructions sent are followed. Use it at home, in bed, in many offices, hotels, cabins—most anywhere! Hundreds of satisfied customers all over the world! SEND ONLY \$1.00 (Cash, M.O., Check) and pay postman \$2.99 plus delivery fees on arrival or send \$3.99 for Post Paid delivery. Complete as shown—ready to play with self contained personal phone . . . WONDERFUL GIFT FOR CHILDREN! Order now at this low bargain price.—Prompt shipment on orders sent now—today! Be first to get YOUR Pakette Radio! (All foreign orders \$5.00 U.S. cash with order).

Pa-Kette Radio Co., Inc. Dept. PS-12 Kearney, Nebraska

LATHE OWNERS—ATTENTION

If your present metal lathe is without power cross-feed, you can now build your own. All parts available from your nearest mill supplier or jobber and scrap box. Positive non-slip performance—no belts used. Adaptable to all metal screwcutting lathes. Make the most of this winter in your shop. Detailed pictorial drawing and complete instructions sent postpaid \$2.95. Send Money Order today to:

JAMES B. WATERS, JR., Dept. A,
4412 Georgia Ave., N.W., Washington 11, D. C.

'PLASTICS'

Work in a fascinating and profitable hobby. Just out—our latest fabricating manual. Tells you how to work with Plastics. Our new Catalogue provides all needed materials: Plexiglas—Lucite—Tenite—Catalin—Acetate—all in sheets, rods, and tubes. Complete line of cements, dyes, accessories and supplies. Send 20¢ today for Catalogue and Handbook. We apply this amount on initial order.

HOUSE OF PLASTICS

8648 Linwood Avenue, M. O. Dept., Detroit 6, Michigan

FENCING World's Finest Sport

Exciting Fun—Harmless

Just Out! Two 3 ft. Spring Steel Foils with Safety Rubber Buttons. Complete Outfit 2 foils (swords) with hand guards and Free Instruction Book Now Only \$1.98 Postpaid. A healthful & clean sport, makes you Strong & Alert. Instruction Book teaches Quickly—Easily. Mail check or Money Order for \$1.98 Today. Add 28c for Foreign postage.

LEE PRODUCTS CO., 1613A- First Ave., New York 28, N.Y.

HYPNOTIZE ANYONE

• Yes, anyone in 5 seconds. Secrets revealed. Exciting experiments. Overcome inferiority complexes, excessive smoking, alcoholism, stuttering, nailbiting, phobias, insomnia, fear, manias, stagefright. Improve your memory and concentration. Private and class instruction available at Institute. Complete practical home-study course. . . \$2

POWERS INSTITUTE OF HYPNOTISM 2932 Wilshire Blvd. Dept. 22, Los Angeles 5, Calif.

PILOTS' JACKETS

(Left) NEW AIR-CORPS B-15 Style. Green poplin. Warm alpaca wool pile lining. Genuine Mouton fur collar. 4 Pockets. 36-46. \$14.75

(Right) SHEEPSKIN LINED JACKET. Brown leather. Army B-3 style. 34-46. . . . \$15.95

Sheepskin Leather Pants. \$5.95

OVERSHOES. Air Corps A-9 Rubber soles—tops, Felt lined. Zipper \$6.95

Write for FREE Illus. List Army Surplus. Orders sent postpaid except C.O.D.

Satisfaction or Money Back

CONSUMERS CLOTHING CO., Box 4-S, 26 Greene St., New York 13, N. Y.



TALK-SING thru your own radio

with

RADIO MICROPHONE

Be the life of the party. Put on your own broadcasts at home. Talk-Sing, make announcements from any room. Wonderful voice practice. Microphone easily attached to any radio. Follow enclosed instructions. SEND NO MONEY—pay Postman \$1.98 plus postage. Send Money Order or check and save postage.

EMPIRE RADIO & TELEVISION CO. (Dept. R1) 1521 Bedford Ave., Brooklyn 16, N. Y.

SOLID BRASS 12 FT. PORTABLE RADIO ANTENNAS

Real \$15 Value Now Only \$4.95 Postpaid FOR HOMES, BOATS or AUTOS

Just Out! Gov't surplus used on Army tanks. These telescopic rustproof antenna have tremendous pickup eliminate dangerous wiring. Solid Brass throughout practically insuring NOISE FREE RECEPTION.

12 Exceptionally Rugged Sections compress into 1 ft. 4 in. Handy for Camping Trips, also Useful for Transmitting, FM & Television sets.

Each antenna comes with clamps, nut, lug, and wire. Easy to install anywhere.

QUANTITY LIMITED

ORDER TODAY. A real \$15 value for only \$4.95 Postpaid. Mail check or money order now or sent C.O.D. plus postage. Money back in 10 days if not satisfied.

RADIO HOSPITAL 442 East 86th St., Dept. B12 NEW YORK 28, N. Y.



EXCITING FILMS



Thrill YOUR AUDIENCES

WITH LIFE-DEATH BULLFIGHTS... "CAMERA THRILLS"... UNUSUAL FILMS OF DANGER AND DARING!

Send only one dollar for "GLAMOROUS EXCITING STARS," featuring Hollywood's most Beautiful Daughters in delightful scenes.

MAIL THIS COUPON—NOW!

EXCITING FILMS, Dept. PS-3
1071 El Centro, Hollywood 38, Calif.

Please rush me the thrilling movie, "Glamorous Exciting Stars," with four color brochure listing all EXCITING FILMS for which I enclose only \$1.00.

Name (print)

Street

City

State

Check 8mm 16mm Sound

RUPTURE!



An amazing Air-Cushion Invention allows body freedom at work or play. Light, neat, cool, sanitary. Durable, cheap. Day and night protection helps Nature support weakened muscles gently but surely. No risk. Sent on Trial! Write NOW for free Booklet and Proof of Results. All correspondence confidential.

Brooks Company, 163-A State St., Marshall, Mich.

**FOR STEREO PICTURES, IT'S
STEREO-TACH!**

Take Third Dimension Pictures with the **STEREO-TACH** and your own camera! There's nothing in photography so startlingly beautiful and lifelike! You can't reproduce a 3-dimension picture in flat 2-dimension printing!

Outfit No. 101—"Tach and Transparency Viewer (for transparencies, with 35MM cameras) **\$22.50***

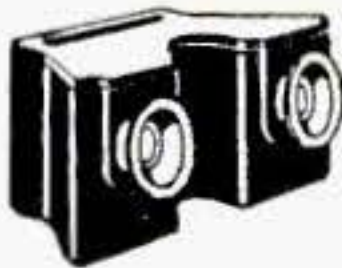

Outfit No. 100—"Tach and Print Viewer (for stereo prints, with both 35MM and other size cameras) **\$16.25***
*Plus Tax.



The Stereo-Tach

Transparency Viewer For Third-Dimension Projection, the **STEREO-FLECTOR!** Just Out! See your dealer or write. **ADVERTISING DISPLAYS, INC. Dept. PS-10 COVINGTON, KENTUCKY**

HOW TO Fight! Wrestle! Jiu-Jitsu!

FREE



Plus Weight Lifting! Strong Man Stunts!
Be prepared to protect your family, friends, yourself in any emergency! Be admired! George F. Jowett, Champion of Champions, gives you free his "SMASHING CHAMPION SECRETS." Contains many "HOW-TO-DO-IT" pictures that quickly and simply show you how to powerfully deliver a knockout, how to break any hold, how to overpower any opponent plus weight lifting and strong man stunts! Inside professional "Tricks of the Trade" proved successful by police, armed forces, fighters, wrestlers, etc.! Free for a limited time with this sensational offer!

YOU NEED HE MAN FITNESS TO HANDLE ANY TOUGH SITUATION!

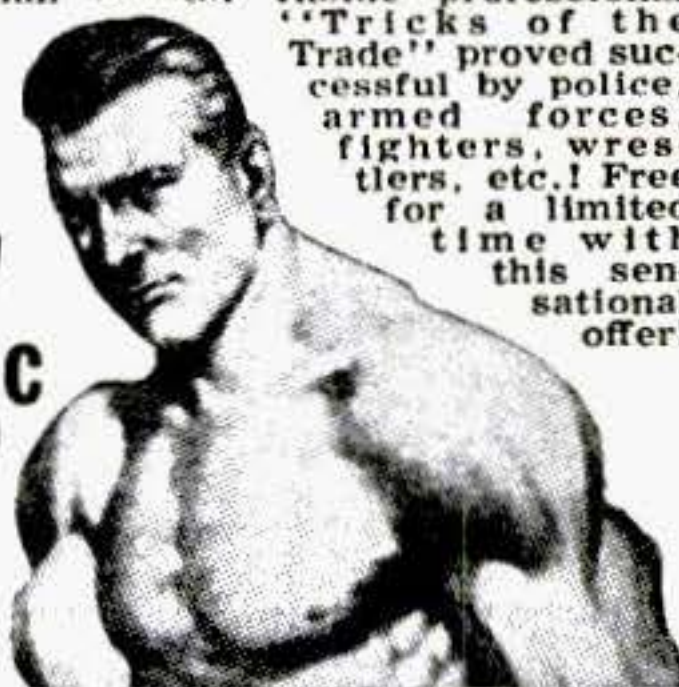

NOW! All 5 Famous JOWETT COURSES **25c**
in 1 Complete Muscle Building Volume!

LET ME PROVE I CAN MAKE YOU

COMMANDO-TOUGH OR IT WON'T COST YOU A CENT!

says: *George F. Jowett* **WORLD'S GREATEST BODY BUILDER**

Give Me 10 Minutes Learn My Time Tested Secrets of Strength

I'll teach you the "Progressive Power Method" that rebuilt me from a physical wreck condemned to die at 15, to the holder of more strength records than any other living athlete or teacher! Has proven it builds the strongest, handsomest men in the world. Let me prove on a money back basis—that no matter how flabby or puny you are that I can add inches to your arms, broaden your shoulders, give you a man-sized chest, powerful legs and a rock-like back—in fact power pack your whole body so quickly it will amaze you—right in your own home! I'll bring to life new power in you inside and out, until YOU are satisfied you are the man you want to be.

PROVE IT TO YOURSELF IN ONE NIGHT

Send only 25c for my 5 easy-to-follow, picture-packed courses now in 1 complete volume "How to Become a Muscular He-Man." Try it for one night! Experience the thrilling strength that surges through your muscles.

10 DAY TRIAL!

Think of it—all five of these famous courses now in one picture-packed volume for only 25c. If you're not delighted with this famous muscle-building guide—if you don't actually FEEL results within ONE WEEK, send it back and your money will be promptly refunded!

I am making a drive for thousands of new friends fast—REGARDLESS OF COST!

SO GET NOW MY 5 Muscle Building COURSES
(Valued at \$5 each)
All in 1 Great Complete Volume Packed With How-To-Do-It Pictures!
Now, this "get-acquainted" extremely low price of only 25c is your chance to build a body you'll be proud of! Follow Jowett's easy method of muscle building NOW!

For Only 25c

PHOTO BOOK OF FAMOUS STRONG MEN!

FREE!

Photos that inspire you to might and muscle. Free with order.



FREE GIFT COUPON!

Jowett Institute of Physical Culture Dept. P S-712 230 Fifth Avenue, New York I. N. Y.

George F. Jowett:—Please send by return mail, postpaid, FREE "Smashing Champion Secrets." FREE Jowett's Photo Book of Strong Men, along with all 5 Muscle Building Courses, 1. Molding a Mighty Chest, 2. Molding a Mighty Arm, 3. Molding a Mighty Grip, 4. Molding a Mighty Back, 5. Molding Mighty Legs—Now all in one Volume "How to Become a Muscular He-Man." Enclosed find 25c, NO C.O.D.'S.

George F. Jowett
Champion of Champions

NAME.....AGE.....
(Please Print Plainly, Include Zone Number)

ADDRESS.....

V-8 DUALS & SINGLES

MUFFLERS
STEELS and ALUMINUMS with a motorboat tone
SINGLES, Chev, V-8, Plymouth, Steels \$5.50, Aluminum \$6.50. Chry., Olds., Buicks, etc., Steels \$7.50, Aluminum \$8.50. V-8 and MERCURY DUALS, Steel \$17.50, Aluminum \$20.00. Aluminums are guaranteed for life of your car.
DEALERS WANTED

SANDEE MUFFLER CO.
7523 S. WESTERN AVE., LOS ANGELES 44, CALIF.

RADIO—FM TELEVISION

Operators, Radio Shop Owners, Radio-Television Technicians, Modern equipment—uncrowded facilities. New classes monthly. Free bulletin. Approved for veterans. Member, Los Angeles Chamber of Commerce.

WESTERN RADIO COMMUNICATIONS INSTITUTE
631 W. Ninth St. Dept. P-10 Los Angeles 15, Calif.

Lucrative positions open to technical specialists. WRCI graduates employed as Broadcast Operator-Engineers, Air-line Flight & Ship Radio Officers, CAA & Police Radio Technicians.

Stromberg WINTER LAYERS

SILVER SPANGLED HAMBERGS. Breeders strictly selected, PULLORUM TESTED. Specializing in Large Type Pedigreed Sired **WHITE LEGHORNS** and High Production **WHITE ROCKS.** 22 leading varieties. Also Started Chicks & Ducklings. **FREE CATALOG.** Stromberg Hatchery, Dept. 814, Ft. Dodge, Iowa

MAKE HOLLYWOOD STYLE CEMENT POTTERY. birdbaths, benches, coffee tables, stucco-rock, rustic garden walks, etc. Many more. Color concrete with chemicals. Start with small capital. 10c brings sample, pictures, details.

HOLLYWOOD CEMENTCRAFT
8527-B Wonderland Ave. Hollywood 46, Calif

LEARN WATCH and CLOCK REPAIRING

Start training now for a better paying job or your own profitable business. Qualified Watch Makers are in demand. Unlimited opportunities. Intensive practical training by experienced watch makers. Veteran operated. Write for full details. Indicate if Veteran.

SCIENTIFIC SCHOOL OF WATCH MAKING, Dept. PS-12
3923 San Fernando Road Glendale 4, Calif.

BE YOUR OWN BOSS!
LEARN ELECTROPLATING
HIGHLY PAID FIELD

UNCROWDED, interesting business. Part or full time. Common school education sufficient. Chromium, Nickel, Silver, Gold, etc., money making trade secrets. Learn at home in spare time. Send postcard today for **FREE** electroplating idea booklet.

PLATER HYDE
432 F Street Room 522
San Diego 1, California

3X ARMY TELESCOPE

Original Cost \$150.00 — Our Price \$7.50



ALL COATED LENSES — BRAND NEW

An ideal gift for viewing objects, landscapes, seashores, etc. The high resolving power of the six coated lenses, five of them achromats will bring out great details. For the experimenter it can be dismantled and used for hundreds of projects. Length 22½ inches, 36° Field. Postpaid \$7.50.

Hobbyist Lens Set—Magnifiers, Reducing lenses, positives, negatives, etc. 10 piece lens set. \$1.00

500,000 Lenses and Prisms. Send 3c stamp for "Bargain" List

A. JAEGER'S

123-26B ROCKAWAY BLVD., SO. OZONE PARK 20, N. Y.

\$6.95

POSTPAID
including
Two Arrows

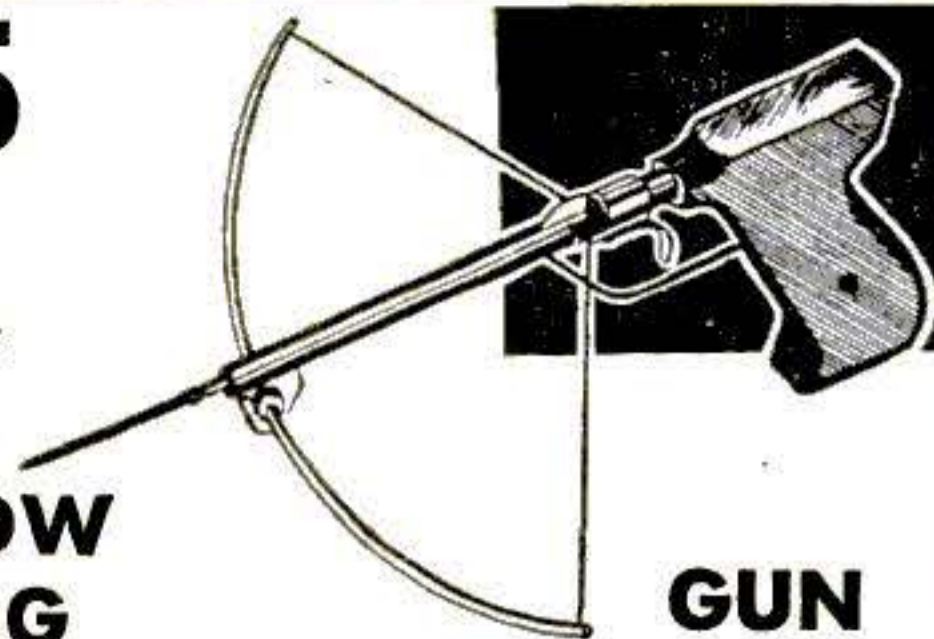

CROSS-BOW SPORTING GUN

Compact powerful pistol grip gun. 35-lb. bow pull — ideal for small game hunting, frog spearing, target shooting, etc. Non-corrosion construction throughout.

Extra arrows \$3.50 per doz. — 45c ea. Special harpoon arrow for underwater goggle fishermen, \$1.40 ea. All C.O.D. orders 30c extra.

JERED ENGINEERING & MFG. COMPANY

1024 S. Washington St.

Royal Oak, Mich.

ASSURE EASY WINTER STARTING

ELECTRIC MOTOR HEATER

- Safe—"Black Heat" element can't ignite gas fumes.
- Keeps engine warm. Prevents moisture condensation in carburetor.
- Unconditionally guaranteed.

150 watt heater, wt. 14 oz., 8" long, 2" dia., 8' waterproof cord, 110 v.

FACTORY TO YOU \$3.50

Send money order or request C.O.D.

plus postage



W. T. DRIVER, Manufacturer
2646-37th Ave. So., Mpls. 6, Minn.

BUILD YOUR POWER TOOLS

WITH OUR GUARANTEED INDUSTRIAL BALL BEARING ARBORS

New Departure Self Lubricating Bearings 10,000 rpm



B33—\$4.95 PP
5/8x4 1/2 Spindle
B15 Plain Spindle \$3.50 PP.



(No extra charge for left hand threads)
C4-1/2x12 1/2 spindle, housing 2x8 \$8.25 PP.
C5-5/8x12 1/2 spindle, housing 2x8 \$8.25 PP.
C6-3/4x12 1/2 spindle, housing 2 1/4x8 \$9.25 PP.
D8-1x17 1/2 spindle, housing 2 5/8x11 \$17.00 PP.
1 INCH BETWEEN WASHER AND COLLAR

SHAPER ARBORS 3 inches between collars, C4-1/2 \$14.25, C5-5/8 \$14.25, C6-3/4 \$15.25, D8-1 \$23. B25-Y2x2" cap. Flange Mount, \$5.50

SPECIAL SAW ARBOR Lengths for Y2, 5/8, 3/4 add \$1.50

SANDING DISCS 8" dia \$3.00, 10" dia \$4.00—1/2, 5/8 3/4 hole

POLY PRODUCTS, 406 S. Chester, Ct. 1a, Pasadena 5, Calif.

Say You Saw
It In Popular Science

FOR CRAFTSMAN, CARVER, SCULPTOR

Sculpstone



With the beauty of jade and workability of wood, Sculpstone appeals to hobbyist and artist alike.

No special tools are required. Sculpstone can be cut with a knife, filed, drilled, sandpapered, or turned on a lathe.

Sculpstone is mined in Egypt and the Far East and closely resembles jade. Its color ranges from white to black, blue to green, and pink to red. Send \$1.00 for Introductory Kit and price list. Special Xmas Hobby Kit sent for \$5.00. Large sizes and crude stone available. Postpaid: No C.O.D.

SCULPSTONE INC. 178 Suffolk St. New York 2, N. Y.

AMPLIFIER

For Call System or Phono. Amplifier

Compact-Wired Ready to operate. Uses 35Z5-50L6 **\$1.95**

25% Deposit Required

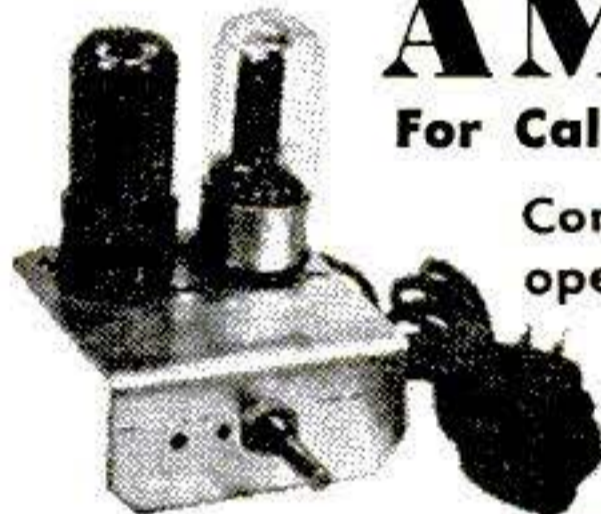

SINGER RADIO & TELEVISION

553 Market St., Dept. C, Newark 5, N. J.

RUPTURED?

PAY NO MONEY! \$3.50 FOR THIS TRUSS

To all who try Newer Rupture Relief Method

All you do is try a Doctor's invention for reducible rupture in the privacy of your own home on our trial plan. Easy and comfortable to wear. Has no leg straps—no elastic belts—no leather bands. Holds rupture UP and IN. If for any reason you do not like it, return it within 30 days but keep the special \$3.50 Truss. It's our gift to you for making the trial. Write today for free measurement service and trial offer.

PHYSICIAN'S APPLIANCE CO.
2906 Main

9311 Koch Bldg.
Kansas City 8, Mo.

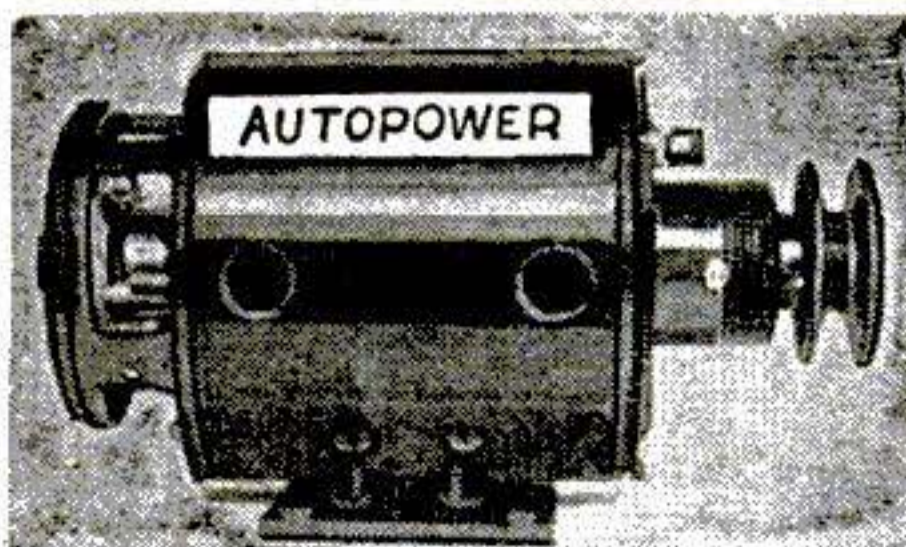

TURN SCRAP INTO MONEY

AUTOPOWER tells you how in plain, easy, simple, and illustrated instructions that anyone can follow. Change auto generators into useful, practical AC and DC generators and motors with voltage from 2 to 1,000 volts, for power, light, welding, radio, sound, etc. No previous experience nor special tools needed. Generators can be driven by wind, water, fan belt, etc. Already used and endorsed by thousands. Send for your copy of "AUTOPOWER." Only \$1.00 postpaid.

AUTOPOWER INC., 918 South Theresa St., St. Louis 3, Mo.



THE GREATEST
THING

IN
PLASTICS!

PLASTICAST



PLASTICAST is a liquid plastic; can be poured into ANY kind of mold or container. Hardens in a few minutes into a transparent solid, clear-as-glass, tough-as-steel plastic! No tools or machinery required. Ideal for imbedding flowers, butterflies, photos, souvenirs, and for making beautifully brilliant jewelry, gems, displays, fishing lures, magnifiers, lenses, knick-knacks and novelties. Easily cast into sheets, rods or blocks, ANY shape. ANY color. **EVERYTHING FURNISHED** for making over 200 attractive articles! C.O.D. orders accepted with \$1.00 deposit.

COMPLETE MASTER OUTFIT, (postpaid U.S.A. only) \$3.00

MULTIPLEX MOLD COMPOUND makes flexible molds in 15 minutes from any original. Never spoils, can be used over endlessly. \$1.75 pound.

FREE SPECIAL OFFER! 3 attractive molds free with every outfit. Also free, valuable manual on **MOLD MAKING** and **CASTING** with Liquid Plastics, Liquid Ivory, Liquid Marble, Wax, Plaster, Alloys, Latex, Plastic Wood, Clay, etc. Sent free for 3c stamp.

PLASTICAST CO., (Dept. A)

5961 Madison St. (Send order to nearest address) P. O. Box 987
Chicago 44, Illinois Palo Alto, Calif.

ANALYZE

Auto Exhaust and Furnace Gases

WITH

NAVY TYPE THERMAL CONDUCTIVITY CELL

SIMPLE—QUICK
LOW PRICED

Send money order to:

T.C. SURPLUS SALES CO.

75 Clinton Street
Newark 5 New Jersey

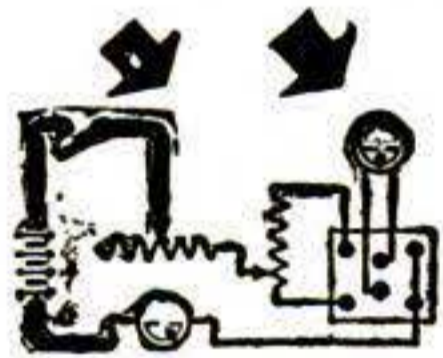

\$9.95
Postpaid

Full
Instructions
Included

POWERFUL AIR PISTOL

Precision made "Sportsman Jr." is Safe, Accurate. Heavy; balanced like real automatic. Shoots B-B's, Darts, Pellets. Lots of fun for indoor target practice. With adaptors, ammunition, packed in attractive gift box. Send \$3.95 Check or Money Order. Postpaid.



SIDNEY SMITH INTERNATIONAL

1112 Wilshire Blvd. Los Angeles 14, California

REPAIR CRACKED BLOCKS AND HEADS—

External and internal leaks in blocks, cylinders and valve ports quickly and easily with **LUSCO PLASTIC SEAL**. **90 day Service Guaranteed** or your money back. Send money order or check for full pint—more than sufficient for average repair. **\$3.00** Postpaid

C. F. LUSK CO., 5916 Bonna Ave., Cleveland 3, Ohio

Everyone Can Afford This LATHE!

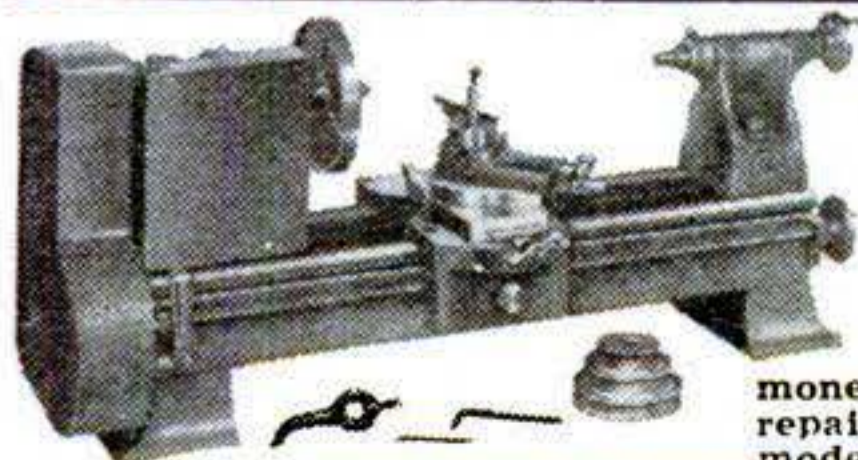

• For Farms, Home Work Shops, Model Builders, Hobbyists

There's hardly a hobbyist, workman, farmer or tinker who can't buy this metal turning lathe! Use it to earn money; develop inventions; make repair parts; do machine work on models. Has V-Way Bed, automatic

power feed; OTHER BIG FEATURES. 8" Swing; 10" between centers; 1/2" hole through spindle; 22" bed. Weighs 72 lb. Guaranteed. **\$45**
Price complete, except motor, f.o.b. Lansing

SEND FOR FREE LITERATURE!

Rosemoor Mfg. Co. 2608 Bernice Rd. Lansing, Illinois

It's EASY to USE the
ELECTRIC PEN . . .
BURN YOUR OWN DESIGNS
AND MANY OTHER GIFTS

BURN-RITE Detachable PEN



Underwriters' Approved

is the only pen on the market. Use like a wall plug. Electrical and receptacle with interchangeable heating units. Safe. Underwriters' Approved.

PRICE, postpaid **\$150**

A XMAS SUGGESTION BURN-RITE SET



Deluxe-4-craft combination kit complete. Contains plaques, foil, leather, water colors, brushes, Burn-Rite pen, colored silicate sand, glue and full instructions. PRICE, postpaid **\$500**

A Miniature Home Foundry in Cast-Rite CASTING SET



Combination electric and gas complete metal casting outfit. Comprises 3 figure mold, handles, electric stove, ladle, vise, jars of paints, brush, and 12 bars antimonial metal.

PRICE, postpaid **\$400**

"Inquire at all leading stores for Rapaport Products. If your dealer can't supply you write direct to Rapaport Bros. Address all requests to Dept. PS12.

RAPAPORT BROS. INC.
1830 S. WASHTENAW AVE., CHICAGO 8, ILL.

Say You Saw
It In Popular Science

LATEX MOLDS FOR PLASTER AND IMITATION MARBLE CASTING.
50 models to choose from, dogs, lions, horses, dolls, religious items, etc., or molds made from your model. We can help you sell items produced. Write for complete information.
Detroit Art Ind. Inc., 2506 Riopelle, Detroit 7, Mich.

PROFIT or LOSS?

Do You Know?

"MAIL-ME-MONDAY"

Bookkeeping and Tax Method

Has helped thousands increase profits!

Detailed statements prepared by electric accounting machines—*Guaranteed Accuracy!*

Have the BEST Get the FACTS



LOOK in YOUR PHONE BOOK for

"MAIL-ME-MONDAY"

or WRITE DEPT. P-10

1929 FIRST AVENUE

SAN DIEGO 1, CALIFORNIA

More than 200 offices in U.S. and Canada



THE ELECTROTOR

Revolutionary! New miniature motive power—ELECTROTOR—Type 240—9/16" W.—7/8" diam.—weighs 3/4 oz. Operates on 3 to 6V DC. Uses less than flashlight bulb. 5000 RPM for models, fans, elec. razors, etc.

PRICE \$2.50 P.P.

No C.O.D.'s America's Leading Hobbyologists

INTERNATIONAL MODELS, INC.

879 Eighth Ave., Dept. S-12, New York 19, N. Y.
(between 52nd & 53rd Sts.)



NOW! YOU CAN HAVE YOUR OWN ELECTRO-PLATING Business

Plate GOLD - SILVER - CHROMIUM, etc.
It's Profitable - Simple - Pleasant

Do as hundreds of successful men are now doing — start your own business! You can plate on metals and non-metals with the VARI-PLATER. Your cost is low, profits are BIG! Don't let this money-making opportunity go by!

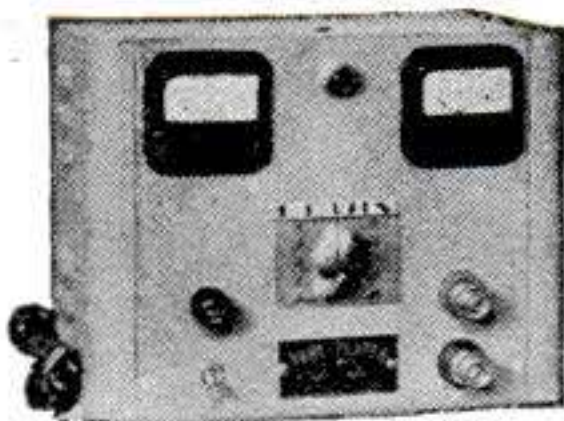

FREE! Write now for descriptive information and complete price list!

The VARI-PLATER — 110 V.A.C. complete **\$5500** Postpaid

LEWIS ELECTRICAL MFG. CO. 1266-B Gun Hill Rd. New York 67, N. Y.

GLOWS
in the **DARK**

5

FREE
Sample!

Be the first to sell luminous house numbers, light switch plates, wall protectors, pull cords. Also luminous pictures, statues, decals, and a host of religious, nursery and other objects that glow in the dark. Get into this new and growing industry. Enormous demand... no competition... sensational demonstration... big profits. Represent a large manufacturer, established over 34 years. Write today for liberal money-making offer and free sample to show how they glow in the dark.

MADISON MILLS 303 Fourth Ave., New York 10, N.Y.

Don't GROPE at Night!

GENUINE RADIUM NIGHT GLOWING BUTTONS

Locate Anything
In the Dark!
Actual Size 1/2 Inch

Amazing new Radi-Glo Buttons... made with genuine radium... glows in the dark without exposure to light. Easily applied anywhere—light switches, dark stairways, photo darkrooms, **Order Today!**

7 RADI-GLO BUTTONS... only \$1
or (3 Radi-Glo Buttons only 50¢)
on instruction card, prepaid. Money back if not delighted.

LUSTROLITE CORP., 6925 Carnegie Ave., Cleveland 3, Ohio

Say You Saw
It In Popular Science

Now a DYNAMIC Industrial Transformer Type
Super Charged WELDER

FOR AUTO, HOME APPLIANCE AND FARM REPAIRS

DESIGNED TO DO HIGH GRADE WELDING *inexpensively*—Maintenance Men, Farmers, Mechanics, Machine Shops, Foundries, Auto, General Repair and Job Welding Shops, all using the DYNAMIC find it so indispensable and useful that they can't afford to be without it.

EASY-TO-OPERATE. If inexperienced you can easily learn to do a variety of high grade welding jobs by following the practical, *simplified Welding and Operating instructions furnished.* Once you see the DYNAMIC in operation you won't want to be without it. Its simplicity will amaze you. In a year the DYNAMIC only costs you about 7c a day. Comes complete ready to operate with helmet, rods, cable, holder, operating and welding instructions, etc.

AN IDEAL AND PRACTICAL GIFT FOR ANY MAN
SAVES YOU VALUABLE TIME AND MONEY

This portable, industrial transformer type *Dynamic Welder* easily carried right to the job can be operated from any convenient properly wired 110 Volt 60 Cycle Line. **WORKS on IRON, STEEL, BRASS, BRONZE and Other Metals.** Has 8 metallic and carbon arc heat stages. Does work you would think only possible with a larger more expensive machine... Can also be supplied for 220 VOLT 60 CYCLE operation and other voltages and cycles at slight additional cost.

DYNAMIC WELDER CO., 13 East 23rd Street, SS, CHICAGO 16, ILL.

FOR ONLY

\$2850 COMPLETE

DO YOUR OWN WELDING

Just a few repair jobs will pay for this machine. A practical and profitable machine tool for any workshop. Make money doing repair work for others.

Write for Particulars
Get Details on our 10 day Trial Offer
Member Chicago Association of Commerce.

BICYCLE REPAIRS

FARM IMPLEMENTS

SHOP WORK

HOME APPLIANCES

AUTOMOBILE REPAIRS

The Pipeline

PIPES COAL IN! PIPES ASHES OUT!

WARMTH WITHOUT WORK

All the work of furnace tending is done automatically by *The Pipeline* Coal Burner. Pipes bituminous coal from any bin to your present furnace, burns it smokelessly and efficiently, and even pipes ashes to dust-proof containers! Modulated warmth regulated by automatic controls.

Conversion models and complete winter air conditioners. Field-tested since 1934. Write for free 20-page booklet.

FITS ANY
COAL BIN

FITS ANY
FURNACE

DUSTPROOF
ASH CONTAINER



POCAHONTAS FUEL COMPANY INCORPORATED
Stoker Division • 341 East 131st Street • Cleveland 8, Ohio



AAF-B-3 FLYING JACKET

Leather, sheepskin lined, zipper front, reclaimed for reissue, like new. The perfect coat for all outdoor sports and outdoor work. Takes the toughest wear. It's warm as toast. All sizes. Army combat field jacket \$3.95. All merchandise reconditioned. Sent C.O.D. Free catalogue of G.I. work clothing.

\$16.95

SURPLUS MERCHANDISE DEALERS, Dept. PS
1214 Broadway New York, N. Y.

PRECISION GEAR KIT



Popular assortment of 6 matched pairs of often needed spur, bevel & worm gears, 3/8" to 3" O.D. (Steel, brass, aluminum, etc.) Designed for numerous step-up, reduction & even-ratio applications. Kit of 6 matched pairs (12 gears)

\$2.49

ALNICO MAGNETS

Powerful ALNICO MAGNETS in many sizes & shapes always in stock. Write for latest illustrated supplements.

Min. Order \$1.00 - Please Add Sufficient Postage
Write for latest illustrated supplements
on magnets & surplus radio parts.

LEOTONE RADIO CO., 67 Dey St., New York 7, N. Y.

Ball-Bearing SPEED WHEELS



Juvenile wheels, solid tire—No Bearings

7" wheels.....60c
6" wheels.....50c
4" wheels.....30c

Semi-pneumatic tired wheels

12 x 1.75".....\$3.25
10 x 1.75".....\$2.75
10 x 1.25".....\$2.00
8 x 2".....\$2.00

Industrial wheels for heavy loads
Semi-Pneumatic

400 x 8, 2 ply tire and tube \$12.50
10 x 2.75".....\$6.75
10 x 2.75" Single Tube.....\$7.25
8 x 1".....\$4.90
6 x 2".....\$2.80

DEALERS WANTED

Free blueprints with all wheel orders.
Send check with order. Shipments f.o.b. Akron.

JIM BROWN TOY COMPANY
1093 Home Ave. Akron 10, Ohio

NEW OPPORTUNITIES

for the man who knows
PLASTICS

NEW BUSINESSES

NEW AND BETTER JOBS

NEW MARKETS • NEW INVENTIONS • NEW HOBBIES

The 1947 Modern Plastics Encyclopedia puts the latest knowledge, experience and know-how of the Plastics Industry at your fingertips.

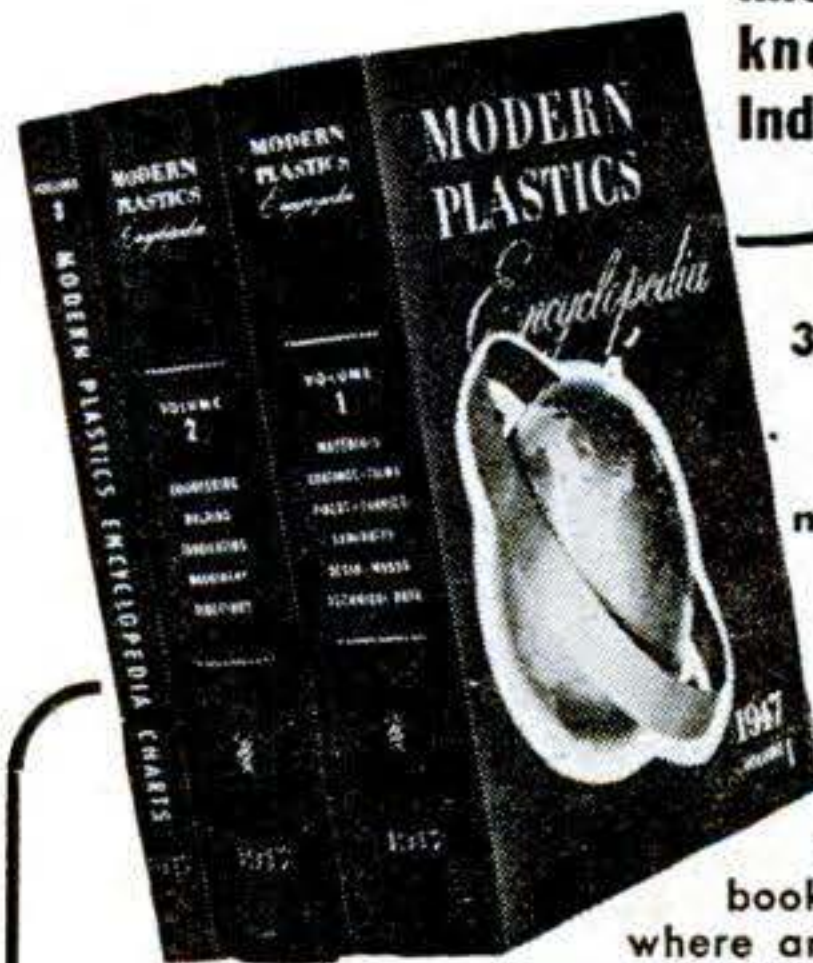

3 volumes — 1556 pages,
8 3/4" x 11 1/2"
899 illustrations,
many full color plates —
10 big identification
and property charts

The only complete reference book on plastics — tells how, where and why to use plastics—and where to buy materials and equipment.

A PRACTICAL GUIDE TO PLASTICS

The 1947 Modern Plastics Encyclopedia covers all the latest developments in raw materials, processing techniques and equipment. It tells you how to select the right material, how to solve design problems, how to process, fabricate, finish and assemble.

It brings you up-to-date on the use of plastics in transportation and communication, industry, housing and home furnishings, apparel, accessories, toys, amusements, and merchandising. It helps you look into the future for plastics.

It covers the entire range of plastic materials—molding powders, coatings, fibers, films, laminates, fabrics, adhesives, plasticizers, solvents, synthetic rubbers and resin-woods—and all the technical data; molding, casting and fabricating methods; machinery and equipment used with each.

Chart Section: 10 big, easy-to-read charts in Volume 3 on adhesives—Plasticizers—Solvents—Plastic Properties—Chemical formulae of plastics, resins and synthetic rubber—Plastics Identification—Coatings—Synthetic rubber properties—Properties of fibers, Low pressure laminating resins.

A Complete Directory Section: Lists who's who among manufacturers, services, molders, fabricators, suppliers, mold-marks, trade names, and trade-marks. Hundreds of authorities on various phases of plastics provide basic information for this great Encyclopedia. It's more than a reference book. It's a book of ideas and practical helps for everyone interested in plastics.

This great plastics guide book costs only \$8.50 prepaid. It's a complete source of information, ideas, and helps. Fill out the coupon below and mail it today and enclose a check or money order. If you decide not to keep the book, just return it within 7 days and we'll refund the entire purchase price. Act now, because the number of copies still available will not be enough to go around. It's the only book of its kind in the world.

MAIL COUPON NOW — MONEY BACK GUARANTEE

PLASTICS CATALOG CORP.,

122 East 42nd Street, New York 17, N. Y.

Gentlemen: Please rush my copy of the new 1947 Modern Plastics Encyclopedia. Enclosed is check for \$8.50 (prepaid price). I understand I can return the book within 7 days and get my money back if I am not satisfied. (Canada \$11.00, Foreign \$12.00)

Name.....

Street.....

City..... Zone... State.....

Learn

WATCH REPAIRING

from
An Approved School
The Largest of Its Kind



**EARN
WHILE
LEARNING**

**SPARE TIME HOME TRAINING
PREPARES YOU FOR BIG PAY**

FREE WATCH working tools and watch included as part of our Watch Repairing Course

The demand for skilled watch repairers—men and women—is increasing with the step-up in the manufacture of watches. Now is the time to prepare yourself in this fascinating profession with the aid of our highly practical **HOME TRAINING COURSE**—in your spare time at home. Start your own business or accept a big pay position.

WRITE TODAY FOR FREE DETAILS—Earn while you learn with an "approved" school. Get the facts—then judge.

ILLINOIS SCHOOL OF WATCH REPAIRING
2870H Elston Ave. Chicago 18, Illinois

AMAZING POST-WAR DISCOVERY

PLASTICROME

CLEANS AND PROTECTS METALS

KIT
75c



PLASTICROME

For Chrome Bumpers,
Grilles, Appliances,
Golf Clubs, Etc.

A PLASTIC PRODUCT THAT DISSOLVES RUST! RESTORES CHROME! PREVENTS CORROSION AND DISCOLORATION!

NO. 1- Makes Metal Shine!

NO. 2- Keeps It Looking Fine!

The modern miracle you can't afford to be without—Two liquids... one dissolves rust, dirt, and grime. The other is a plastic finish that protects against dirt, salt, and rust. Works excellent on all shiny metal. Particulars Free! Send check or money order of 75c for post-paid kit.

PLASTEX COMPANY, 942 Fifth Avenue, Coraopolis, Pa.

NOW YOU TOO CAN BUILD 15 RADIOS

COMPLETE
KIT
\$14.75



**Absolutely no Knowledge
of Radio Necessary**

You Need NO Additional Parts

The PROGRESSIVE RADIO KIT is THE ONLY COMPLETE KIT. Contains everything you need. Instruction Book, Metal Chassis, Tubes, Condensers, Resistors and all Radio parts.

The 36-Page Book written by Expert Radio Instructors teaches you to build radios in a Professional Manner. You start with a 1-tube receiver. Before you are done with this kit, you will have built 11 Receivers, 1 Public Address System and 3 Transmitters.

SPECIAL FREE OFFER!

Electrical and Radio Tester sent absolutely FREE with each Progressive Radio Kit. PLUS FREE membership in Progressive Radio Club. Entitles you to free expert advice and consultation service with licensed radio technicians.

Write for further information, or ORDER your KIT NOW! ONLY \$14.75

Postage prepaid with check or money order.
(Postage not prepaid with C.O.D. orders)

PROGRESSIVE ELECTRONICS CO., Dept. 91
22 Havemeyer Street Brooklyn 11, N. Y.

MAKE \$ MORE MONEY

Applying or Selling

CORKSTONE

A General Purpose Magnesium Oxychloride Flooring

THE MODERN PLASTIC FLOORING

EASY TO APPLY
Here's your opportunity to get into business for yourself applying or selling Corkstone, the economical, top-grade plastic flooring. Plenty of profit. Act without delay!

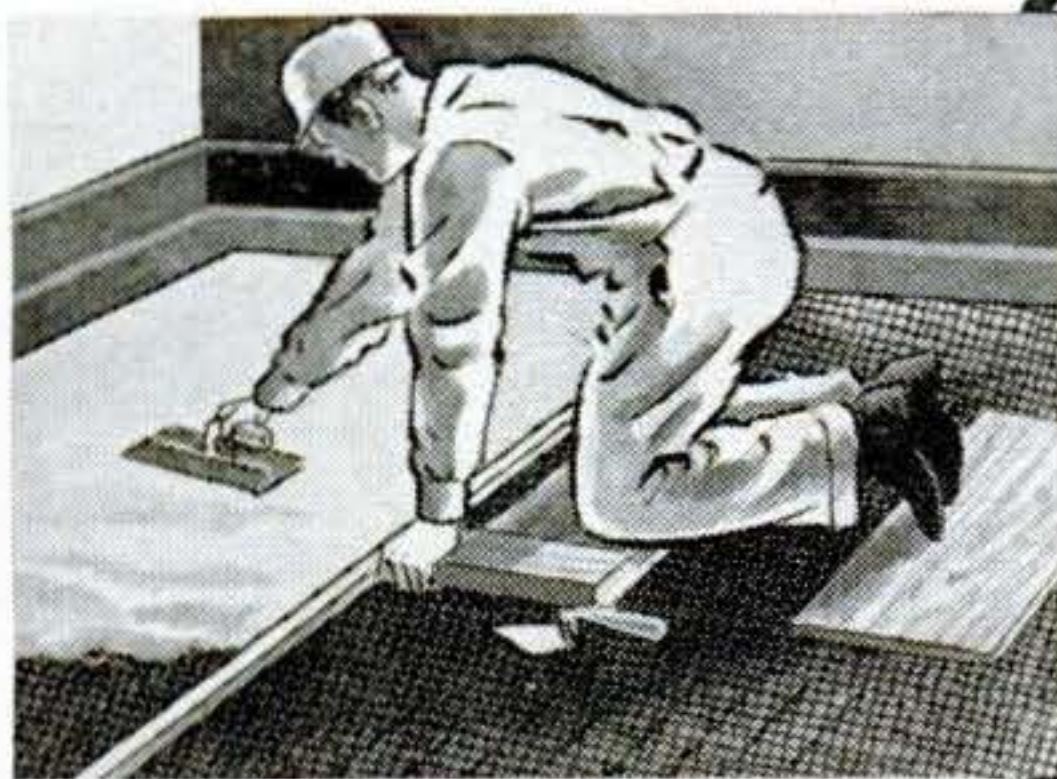

Dealers & Agents Wanted

WRITE FOR DETAILS

LASTING PRODUCTS COMPANY

200 Block S. Franklinton Rd., Baltimore 23, Md.



Bar Bells

Buy Direct From Factory

Write for free booklet
and price list

\$8.95
up

INDEPENDENT IRON WORKS
2416 East 23rd Street, Dept. C
Los Angeles 11, Calif.

Say You Saw
It In Popular Science

TRAIN

Your VOICE!

Results GUARANTEED

We build, strengthen the vocal organs—not with singing lessons—but by sound, scientifically correct silent and vocal exercises and absolutely guarantee complete satisfaction with results. Write for Voice Book, FREE. Sent to no one under 17 years old unless signed by parent.

Perfect Voice Studios, Studio 1369, Kimball Hall Bldg., Chicago 4, Ill.

**EYE-
GLASSES
BY MAIL**

16 Days Trial

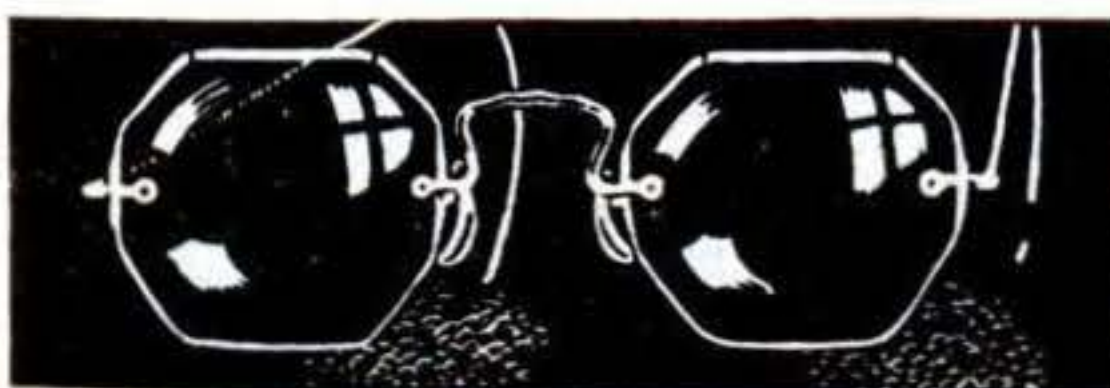

Write Today for Free Catalog. Send no Money
ADVANCE SPECTACLE COMPANY
537 South Dearborn Street, Dept.SP-12, Chicago, Illinois

WAR SURPLUS GADGETEERS' PARADISE

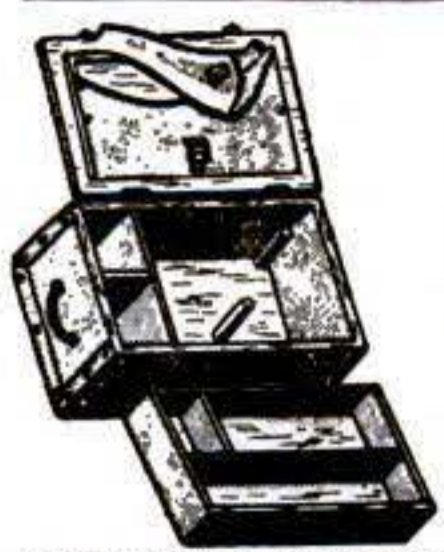

TOOL CHEST
Stands 7 1/2 in. high, 11 in. deep, 16 in. wide. A world of uses for the man who takes his work seriously. **\$3.49**

NAVY COLD-WEATHER PANTS
Tough jungle outer cloth, 100% wool flannel lining, 2 front pockets, 2 hip pockets. Ideal for working outdoors in zero temperatures. Perfect for hunters and fishermen. Small, medium, and large sizes. **\$4.95**



POLAROID GOGGLES
Rubber frame with back adjustment head strap. Comes packed complete in individual boxes. For hunting, fishing, beachwear, skiers, flying, motorcycling, bicycling, farm and ranch wear (dust-proof), and many other uses. **89c**



3 X GUN SIGHT
Precision optical instrument; powerful achromatic color corrected lens; waterproof, dust-proof, shockproof. All bronze and brass body; a find for bird and nature study. Gov't. cost approx. \$175.00. Each. **\$4.95**

STRAIGHTEDGE
Bright steel, square edge 24 in. long, 1 1/2 in. wide. Graduated in yards 1 to 20,000. Originally manufactured for the Engineer Corps at gov't. cost of \$3.37 each. **98c**



AIR CORPS SHEEP-LINED LEATHER GLOVES
Doeskin outer cover that would cost \$12.00 to manufacture today. Mitt type with separate trigger finger—ideal for cold weather hunting. **\$5.95**



6-POWER BATTERY C. O. TELESCOPE
All-prism type instrument, 6 lenses perfectly ground. Clear, flat, color-corrected field of vision. Adaptable as right-angle view finders for cameras. Gov't. cost over \$300. **\$11.95**



STURDY SNOWSHOES
Firmly built of the finest woods. Used by the government. In perfect condition, these snowshoes are ideal for those snow-bound days ahead. Easy to handle. **\$8.95**



BROWN LEATHER SHEEP-LINED FLYERS PANTS
Front pockets, zippers at side and fly. Suspensory. Perfect garment for hunters and outdoor men. Sizes from 36 to 44. Original government cost \$22.50. **\$6.95**

PACKBOARD

Ideal for carrying boxes, chests, 5 gallon cans, radios, and many other items. Balances perfectly. Overall dimensions 24 in. long, 15 in. wide, 2 1/2 in. deep. Carrying straps hold pack secure. Pack attached to board. **\$1.95**



ELBOW TELESCOPE
3-power, field view 13 degrees, 20 minutes. Achromatic, color-corrected. Can be converted by shopmen to a "center-scope" for drill press, jig and tool work. Lens suitable for photography and microscopes. Gov't cost approx. \$150. **\$6.95**

SURPLUS DISTRIBUTORS
924-B N. Plankinton Ave. Milwaukee 3, Wisconsin
All orders shipped FOB Milwaukee, postage collect. Send money order or check. On C.O.D. orders, enclose 20% deposit, balance plus postage on arrival. Money cheerfully refunded if not satisfied.

REPAIRS TO ALL CAMERAS
AMERICAN AND FOREIGN MAKES
Missing parts furnished. Immediate service: Send camera for free estimate. Guaranteed. (Est. 1935)
NORTHWEST CAMERA REPAIR 209-A Loeb Arcade Minneapolis 2, Minn.

FURNACES Gas Oil
Floor furnaces, RANGE burners, GAS burners for natural, mixed and liquid petroleum gases. GUNTYPE oil burners with controls. PRE-CAST fire boxes. BLOWERS, blower wheels, Bearings, etc. Exhaust fans. Wholesale and retail.
PEERLESS SALES, 4320 SHERIDAN BLVD., LINCOLN 6, NEBR.

LOOK! NEW REAR BICYCLE WHEELS

New Departure, Bendix, or Musselman coaster brakes. Chrome hub, spokes and rims. Will fit any 26" balloon tire bike . . . Money back if not completely satisfied.

FRONT WHEELS \$3.00 Postage Included **WRITE FOR FREE CATALOG**

\$6.50 Postage Included **Guaranteed \$10 VALUE**

WHEELGOODS CO. 2607 HENNEPIN AVE., MINNEAPOLIS 8, MINN.

Live in a House?
This light, strong, easily handled device—weight-tested to 500 pounds—will let you *Wash—Paint—Putty Your Windows—Hang Screens and Awnings* without a ladder! Sturdy steel railing—substantial wood floor. Use with combination storm windows. Rubber house protectors. Model H adjustable to all household wall thicknesses—9" to 17". \$10.50 postpaid. \$9.85 C.O.D. plus fee. Money back guarantee. Patents pending. A Morsafe* Product. Agents—Dealers—Territories Open. *Trademark



THEN YOU NEED A WindoStep*

FOR ALL OUTSIDE WINDOW WORK
... UPSTAIRS OR DOWN
An Ideal Gift

MORRISON CRAFTERS, INC.
703 Miami Street, Toledo 5, Ohio

NAME _____
ADDRESS _____
CITY _____ STATE _____
C.O.D. PREPAID
PS-12 SEND CIRCULAR

Copyrighted material

RADIO KIT \$12.95

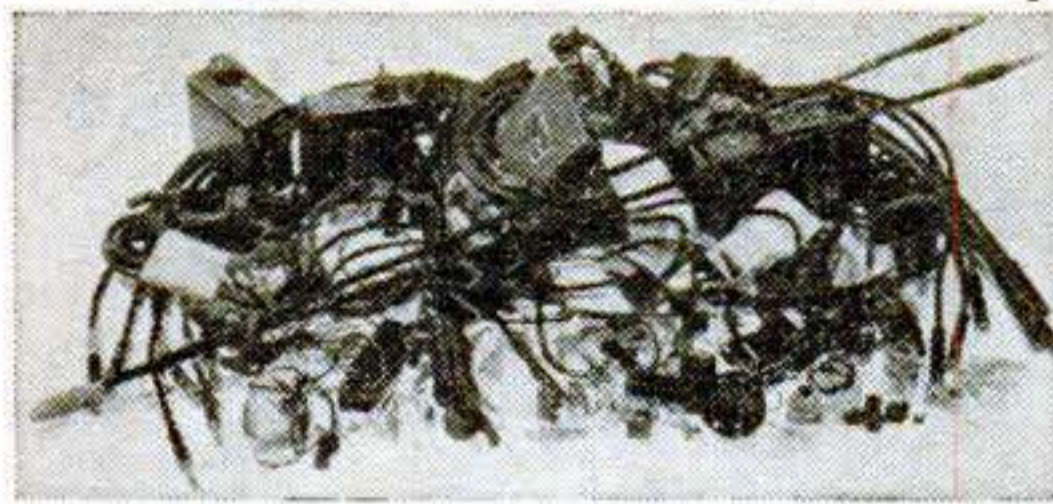

F.O.B. Detroit

NEW GOV'T SURPLUS

LOOK AT WHAT IT CONTAINS

- | | |
|-----------------------------------|------------------------------|
| 6 Ft Wire W-128 | 5 Clamp, Cord SC-A-8637-#2 |
| 2 Ea Mast Section MS-51 | 2 Clamp, Cable SC-A-8637-#7 |
| 6 Headset HS-30 | 2 Clamp, MC-423 |
| 12 Insert M-300 | 6 Cord CD-307-A |
| 1 Microphone Cover M-367 | 5 Cord CD-318 |
| 1 Microphone T-17-B | 6 Cord CD-604 |
| 5 Microphone T-45 | 30 Ft Wire CO-213 |
| 5 Interphone Control Box BC-606-D | 1 Installation, Instructions |
| 5 Bag of Accessories | 2 Kit of Hardware |
| | 2 Conduit Conductor |

SHERRILL COMPASS



Complete with calculator and light. Handy to use on boats, airplanes, trucks, automobiles, etc. New each ... **\$9.95**

ELECTRIC MOTOR



120 HP — 3900 R.P.M. 24 V-A.C. or D.C. Will run on 110V. New each... **\$2.95**

All prices F.O.B. Detroit. Send cash or money order. No C.O.D.'s —Orders shipped by railway express.

RADIO CENTER

2530 E. Davison
DETROIT 7 MICHIGAN

Auto Library in ONE Book

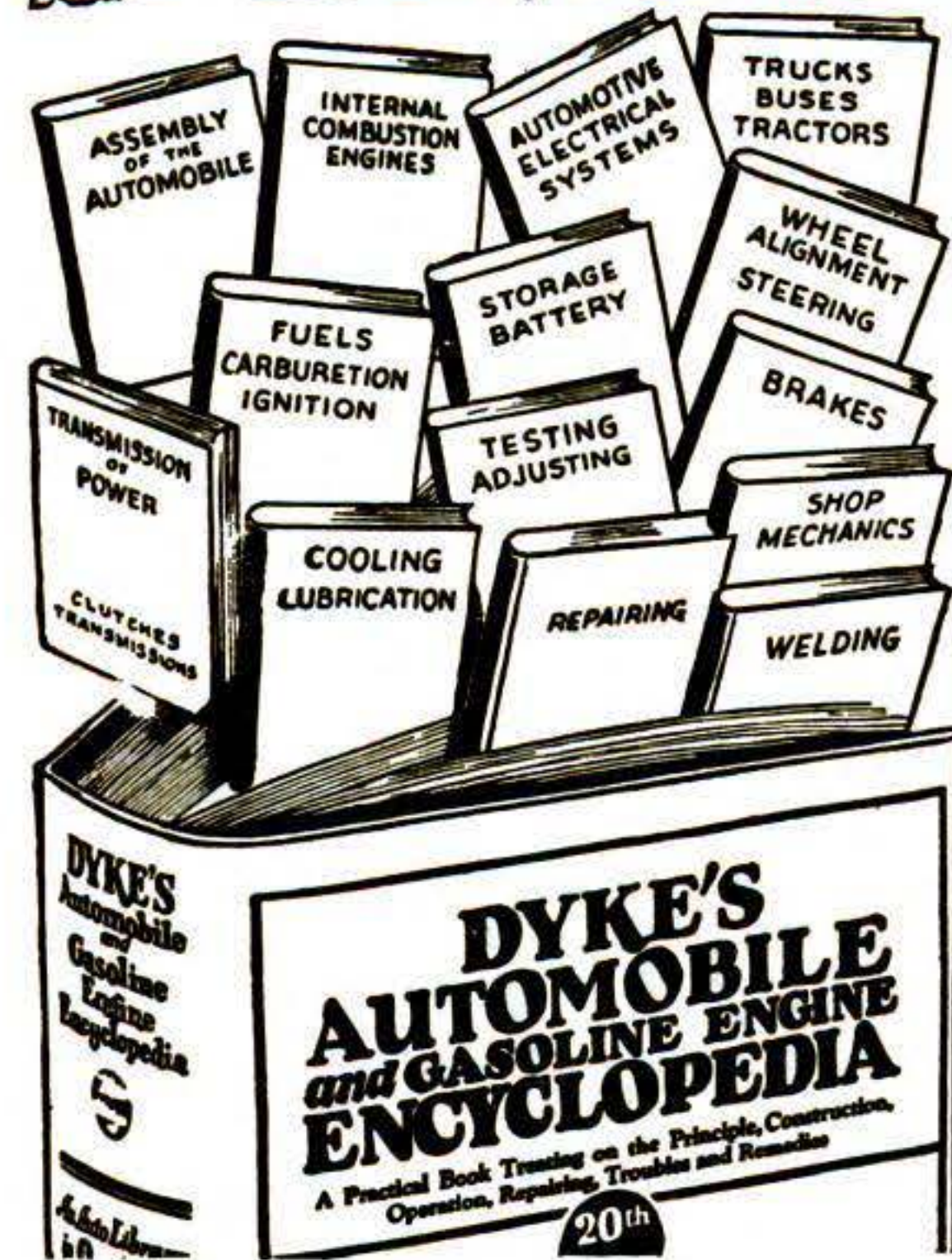

DYKE'S

Leading Auto Book for Over 36 Years

MANY GOT THEIR START with this book.

FOR THE BEGINNER; teaches basic principles.

NEW MATERIAL on trucks, tractors, transmissions in 20th edition.

INCLUDES Ford V8, Chevrolet and other inserts, Diesel and aircraft engines.

This book is a wonder. It fairly oozes information. 1,483 Pages; 4,600 Ills., Charts, etc.; 17,000 Lines Index; Size: 9 3/4 x 6 3/4 x 2 3/4; Wt. 6 lbs.; Price \$7.

MAIL COUPON

Goodheart-Willcox Co., Dept. E-9, 2009 S. Michigan Ave., Chicago. Send Dyke's Auto Book at once. C.O.D. \$7.00 Enclosed. Payment refunded in 5 days if not pleased. If remittance accompanies order we will pay all postage charges under same return privilege.

Name _____
Address _____
City _____ State _____

58 POPULAR SCIENCE



Save-the-Redwoods

Send 10 cents each for these attractively illustrated pamphlets: "A Living Link in History," by John C. Merriam... "Trees, Shrubs and Flowers of the Redwood Region," by Willis L. Jepson... "The Story Told by a Fallen Redwood," by Emanuel Fritz... "Redwoods of the Past," by Ralph W. Chaney. All four pamphlets free to new members—send \$2 for annual membership (or \$10 for contributing membership).

SAVE-THE-REDWOODS LEAGUE
250 Administration Building,
University of California, Berkeley 4, Calif.

LIGHT PLANTS

Used Gov't Surplus—Lowest Price Ever Offered—3,000 watt, 110 volts.

Powered by Briggs-Stratton or Wisconsin 6 H.P. air-cooled engine. For stationary or portable use. Our sale price, F.O.B. **\$124.50**
K. C. **\$74.50**
SPECIAL: 6 to 7 1/2 H.P. Aircooled engine, a real bargain... Only \$74.50



Limited Supply—Immediate Delivery—Order Now
Write for Illustrated Circular

MIDWEST SURPLUS SALES 1520 LOCUST ST.
KANSAS CITY, MO.

Liquid Plastic PROJECT MANUAL



NOW ONLY 25¢

Now make many swell articles with CASTOLITE, amazing New Liquid Plastic. Embed flowers, butterflies, medals, photos. Make jewelry, figurines, gears, parts, models, toys. Can be sawed, drilled, carved, turned. Use home tools. New home project manual now ready. Shows how to get into fascinating completely new field. Have fun, earn money. Send 25c today for your copy.

THE CASTOLITE COMPANY
Dept. P-4 Box 211 Kenilworth, Ill.



HEAVY SOLID SILVER CHINESE MEN'S RINGS

SEND IDEAL HOLIDAY GIFT for HIM

\$6.50 An import of masculine beauty, exquisitely engraved, with Chinese Character signifying HAPPINESS. In ordering state Ring Size. Order by mail. Send Check, Money Order or pay postman

C.O.D. Price includes Federal Tax and Postage. Mailed in Chinese Gift Box.
L. H. WALDRON • 681 Market Street • San Francisco 5, California

CANVAS COVERS Waterproof tarpaulins, war surplus (Used), perfect condition. Originally made for tents. Approx. 5'x8'. Two buttoned together make approx. 80 sq. ft. Complete with buttons attached. Suitable for use as canvas dams, hay covers, truck covers, machinery and equipment covers, etc. Packed in bales 40 each, priced 40 covers, \$1.00 ea; 15 covers, \$1.50 ea. Less than 15, \$1.75 ea. All FOB, Kansas City.

AMERICAN SUPPLY CO.
329 W. 5th Dept. P. S. Kansas City, Mo.

BE COMFORTABLE!



Folding Sponge Rubber Cushion protects you against hard, damp seats at sports events. Ideal for office, workshop, on trips. Send Check or Money Order; \$1 for Standard size, 7 x 13-1/4 x 5/8" (Fits Coat Pocket) or \$2 for Deluxe, (9 x 16 x 3/4"). Postpaid.

SIDNEY SMITH INTERNATIONAL
1112 Wilshire Blvd. Los Angeles 14, California

For Greater Income

LEARN A TRADE



- ✓ **Auto Mechanics**
- ✓ **Body-Fender Repair**
- ✓ **Diesel Engines**
- ✓ **Refrigeration Air Conditioning**
- ✓ **Electricity Electronics**
- ✓ **Radio Servicing**
- ✓ **Building Construction**

The years ahead are going to be big. Grow with them. Prepare now to get into a great, growing industry. Train with C.T.I.—a Nationally Known School. Get the benefits of our efficient Placement Service whether you want a better job or business of your own. You can come directly to our big, well equipped shops, located only a block from the shores of Lake Michigan—or you can begin your training at home by C.T.I.'s SHOP-PROVED HOME TRAINING METHODS. Fill out coupon—mail it today for big, illustrated FREE booklet.

VETERANS!

C.T.I. courses are approved under the G.I. Bill. Just Mail Coupon, we will handle all details. (Low tuition, easy terms if you are not a veteran.)

FREE
BOOKLET



Commercial Trades Institute
Dept. E-112
1400 W. GREENLEAF
CHICAGO 26, ILL.

FILL OUT · CUT OUT · MAIL TODAY!

FACTS FREE FOR MEN WHO WANT TO GET AHEAD

COMMERCIAL TRADES INSTITUTE, Dept. E-112
1400 W. Greenleaf, Chicago 26, Ill.

Send free illustrated Brochures and other information about the field I have checked below.

- | | |
|---|---|
| <input type="checkbox"/> Refrigeration and Air Conditioning | <input type="checkbox"/> Automotive Mechanics |
| <input type="checkbox"/> Electricity | <input type="checkbox"/> Diesel Mechanics |
| <input type="checkbox"/> Radio Servicing | <input type="checkbox"/> Body & Fender Rebuilding |
| | <input type="checkbox"/> Building Construction |

Name _____

Address _____

City _____ State _____

Veteran Non-Veteran

ELECTRIC SHEAR SHARPENER

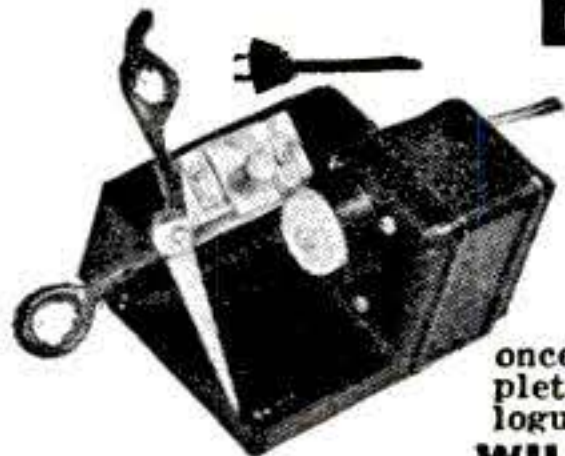

Makes an Excellent Xmas Gift!

Genuine Carborundum wheel ideal for shop or home use. Send remittance with order and shipment will be made at once, prepaid to your door, complete with electrical goods catalogue.

\$9.75
complete with vise

WILLIAM MARVY COMPANY, Dept. 5
479 St. Peter St. St. Paul 2, Minn.

FREE LITERATURE
Write Today

10" TELEVISION KIT

The Television Buy of the Times



High performance low cost television. EASILY ASSEMBLED **\$199.50**
—complete with all tubes.....

With MAHOGANY or WALNUT Cabinet \$229.50. Blonde Maple slightly higher. Newly developed HIGH BRILLIANCE 10 inch Cathode-Ray tube. New Advanced TRUE FM sound, Non-flicker pictures. All parts unconditionally guaranteed 3 months.

Assembled ready to play including cabinet \$262.50
Our 7 inch deluxe television kit still available at \$159.50.

Dealer Inquiries Invited Distributors for Dynamic Television Assoc. Inc.
KENRAD TELEVISION CO., 509 S. 5th. Ave., N. Y. 17, N. Y.

HYDRAULIC VALVES

Sliding type—for operation of double acting hydraulic cylinders. Will handle 10 gallons/minute at 500 Lb./Sq. Inch.

\$7.95

Manufactured by **R. L. FROHRING MACHINE CO. (Inc.)** Chagrin Falls, Ohio

Postpaid.
Write for Folder

Get Into PLASTICS

Make Big Money As Novelty Manufacturer!

Free Book on Plastics tells you how to start your own business. Answers your "Plastic" questions. Read about Flexible Molds, Artificial Liquid Marble and other profitable products.



Act Now! Get started while the field is not crowded. Write Today!

FREE BOOKLET

BING PRODUCTS

Dept #26, 88 Broad Street
Boston 10, Mass.

Christmas Specials

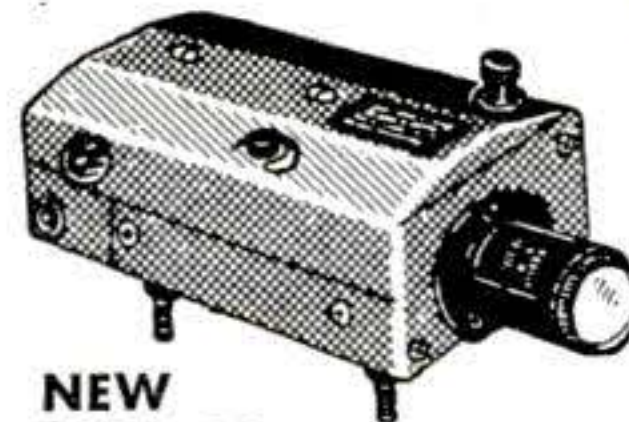

NEW \$25.00
postpaid

FAMOUS ARMY & NAVY G.S.A.P.S. 16 mm movie camera, 1 3/8 in. f3.5 lens, 24 volt D.C. Motor 16-32-64 frames per second. Standard 50 ft. magazine.



\$2.50
post-paid

36 in. SIGNAL CORPS BOX KITE. Light Weight Stainless Steel Tubular Frame covered with a bright orange cloth. Rigid Construction—Collapsible.

Dept. PS 12 **PHOTOCON SALES** Pasadena California
1062 N. Allen Ave.



BIG MONEY IN WORLD TRADE

Get ready now for the biggest World Trade Boom in history. United States firms are eager to ship goods needed everywhere in the world. People in other lands are eager to buy. Learn how you can handle these large orders without capital—how you can run your own Export-Import business from your own home no matter where you live—near a large city or small town. Opportunities for world travel.

SALARIES TO MORE THAN \$10,000 A YEAR

Yes, many Export Managers make that much. But in your own business profits are unlimited. One big order may make you more than you now earn in a whole year.

I TEACH YOU AT HOME

Send at once for free information about my short-cut, low cost course in World Trade based on my own 25 years' experience. Practical, simple. Gets you started quick! No theory. No red tape.

PREVIOUS EXPERIENCE UNNECESSARY

...nor special schooling. Many world traders have had only public school education. I give you the practical knowledge you need. I even give a list of proven representatives in foreign lands to start you right. This is the only course of its kind—your open door to a vast, uncrowded new field of opportunity for you.

WORLD TRADE CERTIFICATE AWARDED

A World Trade Certificate showing your qualifications, on successful completion. World Trade is at fever heat. Write today for FREE DETAILS. State if veteran. Air mail reaches me overnight.

B. L. Mellinger, Director • THE MELLINGER CO. • Exporters and Importers
1416-C Westwood Boulevard, Los Angeles 24, California

10,000 PAIR WAR SURPLUS 4- and 5-BUCKLE ALL RUBBER OVERSHOES

FOR ONLY
\$1.98
PAIR

While they last

- ALL RUBBER
- HEAVY DUTY

Built to stand many years of hard service!



Get ready for winter! Protect your feet with these newly released Government surplus all rubber 4- and 5-buckle overshoes. Made of tough, durable, high grade rubber that will wear a lifetime! Just like new. Perfect condition, easily worth \$5.00 a pair. All sizes.

SEND NO MONEY! Just send name, address, number of pair wanted and size and on delivery pay postman \$1.98 for each pair plus C.O.D. and postage charges. If you prefer, send only \$1.98 for each pair plus 25c postage and save C.O.D. charges.

Satisfaction guaranteed or money refunded.

S & B SURPLUS SALES CO. Dept. PS-25
3244 W. Roosevelt Rd., Chicago, Ill.



U. S. SURPLUS
BARGAIN

POLAROID GOGGLES

Brand new! In original packing. Each with three interchangeable lenses.

SHOCK PROOF FRAME—SHATTERPROOF LENSES

Use them for all outdoors sports, beach, motoring, boating—anything. Heavy wind-proof sponge rubber ventilated frame with snap button lens retainers! Adj. elastic head band. Red, green, amber flexible shatterproof lenses, all instantly interchangeable. They won't last long at this price—it's smart to buy an extra. Post paid in U.S.A.

GROBAN SUPPLY CO., Dept. PS 12
1522 S. Michigan Ave., Chicago 5, Ill.

\$1.00
POST PAID

SUPER-MITE RADIO

PACKS AMAZING POWER!

\$3.99

SUPER-MITE FEATURES!

- World's most powerful miniature radio.
- Uses War-Born midget electronic tubes.
- Covers broadcast band, fully portable.
- Coast-wide reception obtained.
- Powered by midget hearing-aid battery.
- Picture diagram for radio beginners.

Brilliant red chassis, chrome and black dial, streamlined bakelite knobs. Complete kit ready to wire as shown Only \$3.99 Post Paid. Tubes 95c each. This high quality set not available elsewhere at 10 times this price!



ELECTRONIC RESEARCH
1216 Park Row Bldg. New York City 7



SKYSCOPE

The new 3½ inch astronomical telescope that is sweeping the country. This is the first, truly efficient and completely assembled telescope ever offered at such a low price. Equatorially mounted, ¼-wave aluminized mirror, 60 power standard ocular, as illustrated—\$19.75 plus express charges.

Incredible as it may seem, we invite your attention to our free brochure describing its amazing performance and construction.

THE SKYSCOPE COMPANY, INC.
475-D Fifth Avenue New York 17, N. Y.



NOW! WESTERN RINGS

POPULAR SADDLE STYLE for men, women, children. Sterling silver. Ideal gift \$4.95 each or Special Offer two for \$9.00. (Save 10%.) Send check or money order and ring size. Prompt delivery, we pay tax and postage. Satisfaction guaranteed. **THE ROBERT SALES CO., 727 Hennepin Ave., Minneapolis, Minn.**



Say You Saw
It In Popular Science

INVENTIONS WANTED AT ONCE

Patented or unpatented inventions, all types needed by manufacturers. Write for free booklet "MARKETING YOUR INVENTION" and Protective Disclosure Form. We have a tremendous list of firms who may pay cash or royalties for good inventions. For full particulars, write today.

NATIONAL INVENTION SERVICE
1404 Mitchell Street, Dept. A Oakland 1, Calif.

Hollywood Experts Help You **Make Good in RADIO-TELEVISION** at Home

Direct from Hollywood, nerve-center of broadcasting, Television, Radio and Sound activities, comes R-T-A's time-proven and tested home training. Here at last—easy to learn, home instruction that quickly qualifies you for steady, good-pay jobs or your own Radio business. 10 big kits of radio parts given at no extra charge. Get full details at once! Send postal for **FREE BOOK** "How to Make Good in Radio-Television." R-T-A APPROVED FOR VETERANS.

RADIO TRAINING ASS'N OF AMERICA, Dept. PS12
5620 Hollywood Blvd. Hollywood 28, Calif.

SENSATIONALLY PRICED

WELDS • BRAZES • CUTS • SOLDERS

Just plug into nearest socket. Arc furnishes up to 10,000 degrees Fahrenheit. Welds metal up to 3/16" thickness, uses up to 3/32" rod. Cuts all steel including hard tungsten. Complete equipment includes unit plus carbon tipped dual copper electrode Cutting Torch and single electrode Welding Torch with attached alligator clip. Generous supply of welding materials. One welding job may more than pay cost of entire unit. Ideal for home workshop. Invaluable for body and fender shops, garages, repair and machine shops, etc. C.O.D. \$12 plus postage (wt. 4 lbs.) or send \$12 and we pay postage. Money back guarantee. Free Folder on request.

CALIFORNIA TECHNICAL PRODUCTS CO.
6510 WARNER DRIVE • CULVER CITY, CALIF.
DEPT. B-12

ELECTRIC TORCH

Now only

\$12

FULLY GUARANTEED

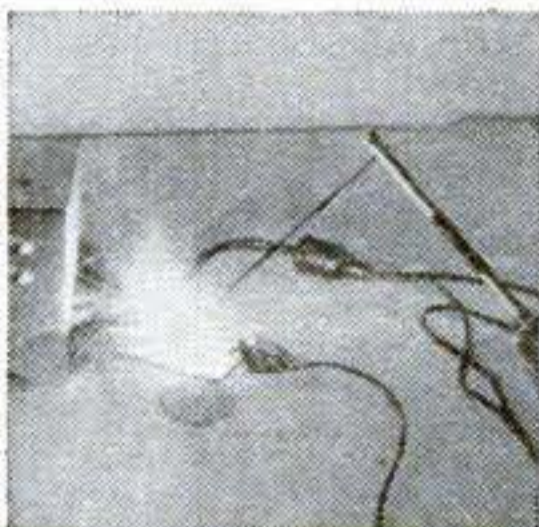

Build this SPEEDY ELECTRIC ENGINE

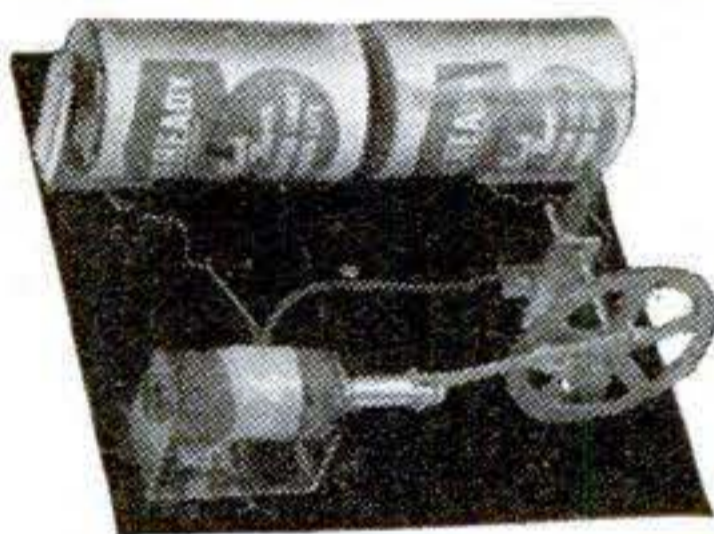

Red flywheel spins 1000 R.P.M.! Flashlight cell operation. Piston action like steam engine! Kit of parts only \$1.95 plus postage. Cash, check, or M.O. Ideal gift. Rush order now!

ELECTROKIT CO., 655 Amboy Ave., Perth Amboy, N. J., Dept. P.S.

TRIGONOMETRY QUICKLY

SPEED UP YOUR TRIG! LEARN SWIFTLY.

With JOSSELYN'S truly great chart, "TRIGONOMETRY SIMPLIFIED", you get answers speedily, easily. This amazing short-cut to ACCURACY can save you hours and days of drudgery. YOUR OWN TEST on your problems will quickly convince you of its excellence. Let it work for you at once! We mail C.O.D. plus postage fee, or send \$1.00, full price, and we mail postpaid.

EDCO SCIENTIFIC CO.
Box 531 Hollywood Station Hollywood 28, Cal.



GET INTO CARTOONING!

Learn cartooning from a professional cartoonist! Create original cartoons and ideas. Send for free details about course. Also cartoonists' magazine. Full of lessons, plans, etc. Only 25c coin postpaid.
Hartman Studios, 2776 California Court, Lincoln 8, Nebr.



ITALIAN ACCORDIONS

Hand Made. Very Best. Lowest Prices. Buy Direct from Factory Representative and Save Money. Send Name and Address for FREE catalog.

ITALIAN ACCORDION MFG. CO.
7600 Cottage Grove Ave., Dept. PS-12, Chicago 19, Ill.

AIR or LIQUID TANKS

Airplane oxygen tanks (used) good condition, holds up to 400 lbs. pressure; non-rusting stainless steel, weighs 18 lbs., 10 1/2 gal. capacity, 24" long x 12" diam., \$4.98. Same specifications 24" long x 6" diam., weighs 5 lbs., 3 gal. capacity, \$2.98. Ends tapped for 1/4" standard pipe thread. Air check-valve to fit tanks. \$5.00 value. 98c. Ideal for compressed air tanks, some bottled gas, or liquids, water supply for house trailers, compressors, floating rafts, buoys, net floats, air horns, air brakes, etc.

Prices FOB, Kansas City—No COD orders
MIDWEST BUY ANYTHING CO.

1520 Locust St. Kansas City, Mo.
Hundreds of other bargains—Write for Circular



ELECTRIC WELDER

AC or DC 110 Volts
Pre-war type—All metal—No chemical—5 year written guarantee. Welds 1/8" thick metal or money back. Repairs tanks, tools, fenders, machine parts, etc. Comes complete with rods, unit directions and eye shield. We also manufacture a set you can

\$645

Complete

learn with for only \$3.95 complete. On C.O.D. mailing charges extra.
ESSAY MFG. CO., INC., Dept. P.S., Quincy 69, Mass.



Time & Date AT A GLANCE

BELL
GUARANTEED
CALENDAR WATCH

Tells time, name of day and date. Day name changes automatically.

No. MT 383 — 17 jewels, water-shock resistant, anti-magnetic, radium dial and hands. ALL STAINLESS STEEL CASE..... **\$55.00**

OTHER SPORT WATCHES WATER-SHOCK RESISTANT

Precision tested, 17 jewels, anti-magnetic, radium dial and hands, unbreakable crystal, sweep second hand. No. MT 197—Stainless Steel Back..... **\$29.75**

No. MT 945—ALL STAINLESS STEEL CASE **\$37.50**

Other fine watches from \$12.65 Tax Incl.

ORDER BY MAIL: Send check, money order or pay C.O.D. THESE LOW PRICES INCLUDE FED. TAX & POSTAGE. Write for FREE Booklet "MT".

Repair Service

All types and makes of quality watches repaired expertly and promptly. Free estimate on request.

BELL WATCH COMPANY, INC.

Time and Life Bldg., Rockefeller Center, New York 20, N. Y.



HERE'S A NEW AND VITAL BUSINESS!

LEARN ELECTRICAL APPLIANCE REPAIRING

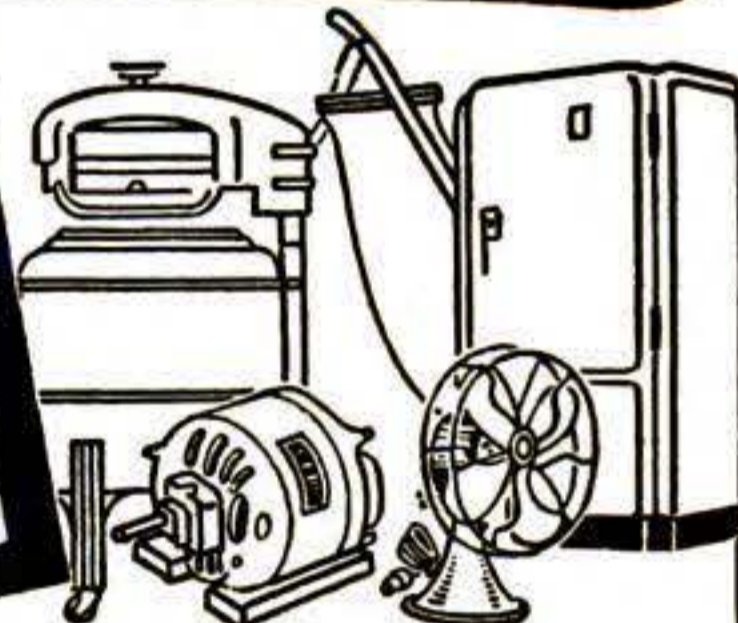

OFFERS BIG MONEY—INDEPENDENCE

If you are mechanically inclined—can hold and use tools will pay you to learn electrical appliance repairing. Operate from your garage, basement, etc. Work as many hours as you wish—the appliance repairman is his own boss. On many types of repairs it is usual for a repairman to charge on the basis of \$5.00 to \$6.00 an hour!

NO PREVIOUS EXPERIENCE NEEDED

Profusely illustrated our new course shows you in simple, easy to understand language plus drawings and photographs, how to make each repair on refrigerators, vacuum cleaners, washing machines, motors, fans, irons, etc., etc. Explains and gives you a working knowledge of electricity, welding, nickel plating, etc. Shows you how to build the power tools you need and how to solicit and keep business coming to you. Not a theory course but an honest to goodness practical course written by and used by repairmen the country over. Price of course is so low that the savings on your own household appliances will pay for it. Act now! Send today for FREE literature. **Christy Supply Co., 2835 N. Central Ave., Dept. D-5901, Chicago 34, Illinois**

Make MORE MONEY

Learn

Screen Process Printing
I SHOW YOU HOW
This Easy Way at Home!



1 HOW TO START YOUR OWN BUSINESS

—My training shows you how you may start your own business and cash in on the tremendous field open to you in Screen Process—with an investment of a few dollars.

No machinery. Print thru stencil mounted on silk stretched frame.

2 HOW TO GET A GOOD PAY POSITION

—Many of my students earn extra money in spare time at home, while learning. My special "Earn While You Learn" lessons, with the Kit of Supplies I give you—show you how.



Make own stencils. Trace lines on stencil film. No art experience necessary.

3 HOW TO EARN EXTRA MONEY IN SPARE TIME

—If you are in the rut of a low pay, uninteresting job, Screen Process work offers you the opportunity to earn good wages and the better things of life for you and your family.



You can print signs, displays, toys, etc., with this simple equipment.

Send for FREE BOOK

My big free illustrated book, "Opportunities in Screen Process," explains the big demand for Screen Process printed Signs and Displays, Toys and Games, Textiles, Decal Transfers, Plastics and Glass, Pictures and Greeting Cards, Advertising Agencies and other businesses. No art or previous experience required. You Learn While Doing with the 2 BIG KITS of SUPPLIES I give you. Write TODAY. STATE IF VETERAN.

CALIFORNIA SCHOOL OF SCREEN PROCESS
3740 OVERLAND BLVD., DEPT. PS-127, LOS ANGELES 34, CALIF.

BRASS Social Security Plates

STAMPED WITH YOUR NAME AND "SS" NUMBER



Beautifully satin-finished (shown 1/8 size). Please print information clearly. Priced at only 50c each, postage paid
50¢
ACME STAMPING SERVICE
Box 836-PS Davenport, Iowa

FLOYD CLYMER'S unbiased book

"INDEPENDENT TEST REPORT ON KAISER-FRAZER CARS"



Read what 3000 owners now think of their K-F cars. Expert, part-by-part analysis. 100 photos. Tells all. 3000-mile test run, Pike's Peak closed car record, gas mileage. Thousands are buying. Order now. \$1.50 postpaid. \$2.50 deluxe ed. Cash, money-order, or specify C. O. D. Money-back guarantee. Clymer, Publisher, Dept. PS. 2125 W. Pico, Los Angeles 6, Calif.

GET INTO YOUR OWN BUSINESS WITH

LIQUID IVORY

A GREAT MONEY-MAKING OPPORTUNITY

Regardless of your age, sex, previous experience we will send you astonishing free facts about your own profitable business with amazing replica LIQUID IVORY, one of the most marvelous synthetics ever developed. With it you can easily produce a wide variety of wonderful items that almost defy detection from genuine ivory. An amazing opportunity to start your own profitable business. **EASY TO START! NO LONG WAIT FOR PROFITS!**

Send Letter or Post Card for Free Details!

EMPIRE TRADES & HANDICRAFTS

BOX 1340

DEPT. PS 12

ST. LOUIS, MO.

New! HEATED AUTO CUSHION



100 Degrees of Summer Heat When You Need It

● Electrically HEATED CUSHION for use in Auto. Durable brown leatherette. Uses less current than headlights. Size 12"x16"...12 feet of cord. GUARANTEED FOR ONE YEAR. Easy to attach. (Apply to any part of body.) Send check or M. O. for \$5.95 and we pay postage. Dealers and Agents wanted.

ONLY \$5.95

MACCHI AND CO., 927 LARKIN ST., SAN FRANCISCO 9, CAL.

ALL TYPES OF IGNITION PROTECTION

IGNITION protection from shorting out due to rain, sleet, snow, excessive humidity, condensation and radiator overflow. Simple, self-application **SHORTSTOP** protects spark plugs, ignition wires, spark coil, distributor cap and base, generator, battery cables and terminals. Gratifying results on inboard-outboard motors, airplane engines, tractors, diesel equipment, motorcycles and scooters, model airplanes and household motors. Tested by leading electrical testing laboratories. Send \$1.00 postpaid today for generous four ounce bottle **SHORTSTOP** giving protection coverage minimum of one year.

CARDINAL CHEMICAL COMPANY, Hawthorne, New Jersey

Say You Saw It

In Popular Science

AMAZING MYSTERY BUTTON



Startles Everybody. With this *Electronic Button* you can make your own Telephone-Amplifier-Detectophone.

Attach this button to piece of cardboard—transmit conversation to another room. Music also transmitted to distant places. Most interesting electrical apparatus ever discovered. Enables you to perform hundreds of experiments. So tiny it can be concealed in dozens of places. A Pre-War Product. *Electronic Button* including 5000 word instruction booklet with 50 illustrated experiments, postpaid, only **\$1.00**

ELECTRONIC PRODUCTS COMPANY, SAINT CHARLES 2, ILL.

U. S. GOVERNMENT JOBS!

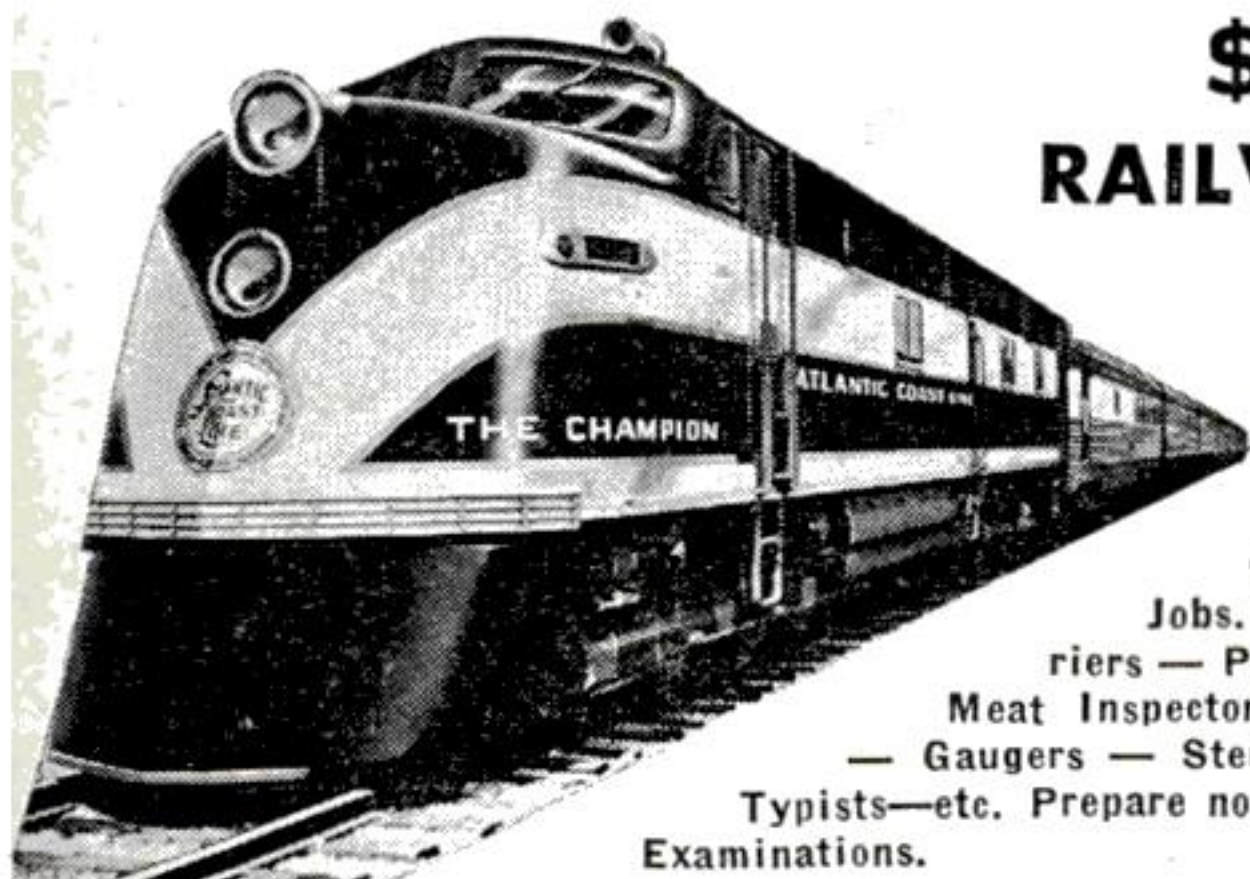

\$1,756 to \$3,021 FIRST YEAR
RAILWAY POSTAL CLERKS
Veterans Get Special Preference

Many other Government Jobs. City and Rural Carriers — Postoffice Clerks — Meat Inspectors — Storekeeper — Gaugers — Stenographers — Typists—etc. Prepare now for 1948 Examinations.

FRANKLIN INSTITUTE, Dept. R81, Rochester, N. Y.

Sirs: Rush to me, without charge, copy of 32-page book, "How to Get a U. S. Government Job," list of positions, and full particulars telling how to prepare for them.

Name.....

Address..... Vet?.....

START A BUSINESS AT HOME...

Like John Lehman, Who Says:

"The complete Fyr-Fyter extinguisher line gives me a steady income and real independence."



Yes, capable men like John Lehman will find an outstanding opportunity with Fyr-Fyter. You can be your own boss... operate in your own town and vicinity... build a permanent, steady income. No capital needed. We carry accounts, make deliveries, pay profits weekly. Thousands of prospects due to the vast need for fire protection.

Write for FREE BOOK

Get details on Fyr-Fyter's famous sales kit... facts on the complete, Underwriters' approved Fyr-Fyter line... how you earn while you learn. Write today! No obligation.

Fine Business for men past 40.

FYR-FYTER CO. Dept. 92-36, Dayton, Ohio

ARMY RADIO PHONES



They're Weather — Water and Shock Proof

When we say they are made to Army specifications, that's enough assurance they must be of best quality. Use them for recording, for batteryless phone, for pocket size set loud speaker or talk through your radio set. We bought a good many of these Radio Phones, they are brand new, and cost a great deal more than you can get them for. A com-

\$1.95

plete dynamic hand mike, 2 earphones, headband, cord set. A wonderful buy for only.....

SUPER SPECIAL CRYSTAL MICROPHONE CARTRIDGE. Dandy for replacement or make your own mike by placing into box. A tremendous value—Only..... **69c**

Send check or Money Order, FOB warehouse

LEEDS RADIO CO.

75 Vesey St. Dept. PS-12 New York City 7

Be an Investigator!

Our course in scientific crime detection may be studied in the quiet of your own home. Investigation training course written and supervised by former U. S. Government Investigator. Write today for full particulars and free booklet. No obligation whatever.

PACIFIC SCHOOLS, INC.

601 S. VERMONT AVE., DEPT. P-1 LOS ANGELES 5, CALIFORNIA



with the "PENCIL-SIZE" handpiece

4 Reasons Why FOREDOMS ARE TOPS:

1. FOREDOMS give you extra power and longer motor life. Motor not dwarfed to fit hand.
2. FOREDOMS give you correct handpiece size for deft, sensitive, fingertip control.
3. FOREDOMS give you freedom from gyroscopic action; fingertip control for grinding, polishing, de-burring, sharpening, cleaning, slotting, milling, etc. on metals, wood, glass and plastics.
4. FOREDOMS' small handpiece size lets you get into those "hard-to-reach" places.

OVER 60,000 FOREDOMS NOW IN USE.

Get the Flexible Shaft Machine that is fast becoming the standard for the nation. Order NOW for immediate delivery. Prices range from \$19.95

Catalog No. 148 on request

FOREDOM ELECTRIC CO.

27 Park Place, Dept. 148, New York 7, N. Y.

WAR SURPLUS AND OTHER BARGAINS

MOTOR-GENERATOR

Emerson Electric Mfg. Co. 3 HP Motor... AAF Type D50 FD-222-0435, 28 Volts DC, compound, 3800 RPM, 115 Amp, windings glass insulated, blower cooled, shaft dimension 5/8", Wgt. 27 Lbs. As Generator, puts out 115 Amps.

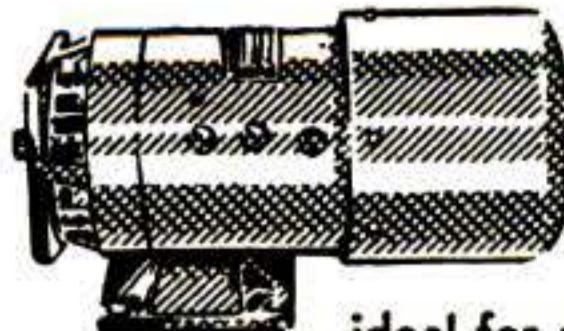

ideal for portable welder.. new \$13.95 each

SEND CHECK, MONEY ORDER or CASH

Transformer Automatic Winding

Co. Filament Transformer, up to 250 Volts, step up or step down, 12 points for variation of voltage, can hook into 110 or 220 Volt and 50 or 60 Cycle Current, Wgt. 14 Lbs., all new... will work any 6-12-24-28 Volt aircraft gadget off house current... \$7.95



25% DEPOSIT REQUIRED ON C.O.D. ORDERS

GOGGLES Military type, with

laminated cellulose-acetate lenses, leatherette frames and elastic cloth adjustable band, all new 2 pair for \$1.00 (one polarized and one clear).



MICROMETER

Chrome plated, precision engineered and carefully tooled to give long life and highest degree of accuracy... all new. 1" capacity \$1.65 each. 2" capacity \$3.50 each.



ALL PRICES F.O.B. CULVER CITY, CALIF.

CLAMPS: Adel Aluminum Co., Rubber lined, assorted sizes, hundreds of uses in any shop. 500—all new, ass't'd sizes \$5.00

AIRBORNE SALES CO. DEPT. PSM 12-7 CULVER CITY, CALIF.

Make More Money in

AUTO BODY and FENDER REPAIRS

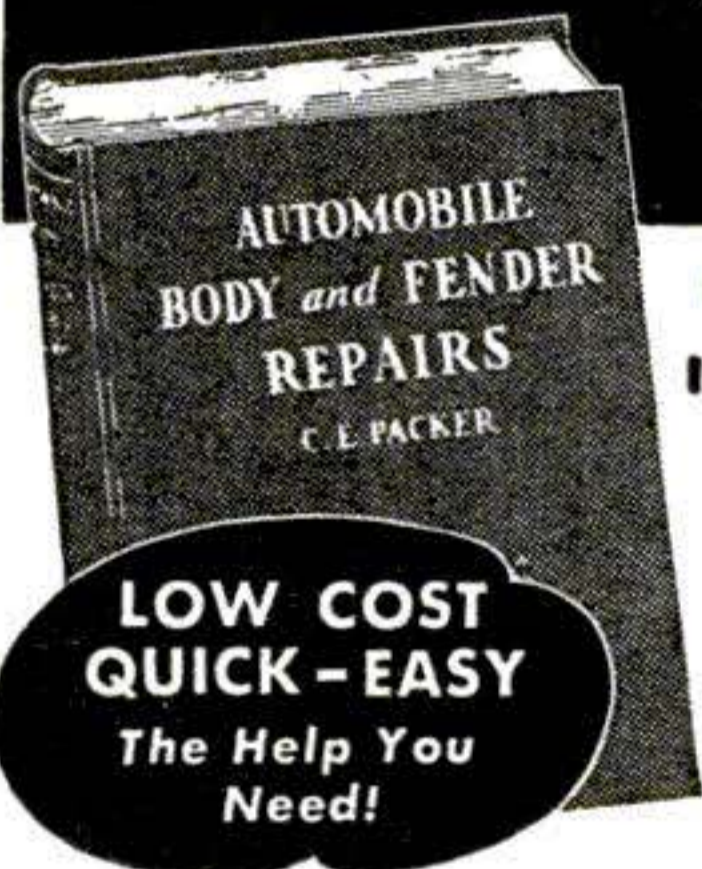

LOW COST QUICK-EASY
The Help You Need!

GET THIS BOOK NOW

In Your Own Home **FREE TRIAL**
Send No Money

GET YOURSELF a share of the big money car owners are spending to keep their older cars looking good. This practical book will put you right into this profitable business. No experience needed. Get a good job or start a business of your own with little or no capital. Biggest selling book of its kind. Thousands in use. Mail coupon today—money back if not fully satisfied.

Mail Coupon

GOODHEART-WILLCOX CO., Dept. 530
2009 S. Michigan Avenue, Chicago 16, Ill.
Send Auto Body and Fender Repair, \$3.50. If not satisfactory I will return in 5 days and you will refund money paid.

() Remittance enclosed, sent postpaid.
() Send C.O.D. Postage extra.

Name.....

Address.....

City..... State.....

HAND GRINDER STONES

41 Piece Assortment

A great value for home and shop. All parts are brand new—packed in an attractive set-up box as illustrated. You'd pay well over \$15.00 if you bought these parts separately. Sent postpaid in U.S.A. Satisfaction guaranteed.

Assortment consists of the following pieces—41 pieces in all.

- 20 Mounted Stones. Assorted shapes and grits, all on 1/8 inch shanks.
- 10 Mounted Stones. Assorted shapes, all on 3/32 inch shanks.
- 10 1 x 1/8 x 1/8 inch grinding wheels. Top quality and all brand new.
- 1 1/4 x 1/8 inch Mandrel.

THE WHOLE ASSORTMENT—POSTPAID, ONLY

ALL BRAND NEW

POSTPAID IN USA

\$4.95

152 PIECE ASSORTMENT MOUNTED STONES, FILES, BURRS, BUFFERS, etc.

An amazing value for home and shop. Actually 152 pieces; mounted stones, abrasives, polishing and finishing parts, files, burrs, etc. You'll find hundreds of uses for this great array of wanted parts. Assortment includes the following:

- 8 Mtd. grinding stones on 1/8" shank
- 2 Fast cutting grinding wheels 3/4 x 1/8"
- 1 Circular Saw 3/4 x 023 x 1/8 in.
- 2 1" sewed muslin buffs
- 6 7/8" cut-off wheels
- 4 Cutters, ass't. shapes 1/8" shank
- 1 3/4 x 3/32 mtd. wire brush
- 3 Ass't. felt wheels
- 1 Drum sander on 3/32" shank
- 2 3/4 x 1/8 x 1/16 in. rubber wheels
- 3 Ass't. bristle brushes, mounted
- 3 Cutters 3/32" shank
- 4 Mtd. wheels on 3/32" shank
- 100 Emery discs, 7/8" med. grit
- 1 Roughing stone
- 6 Drum sleeves
- 1 Felt cone
- 5 1/8 x 1/16 in. mandrels

This great assortment will give you years of service. Regular retail value over \$20.00. Now postpaid in U.S.A. only **\$8.95**

ACTUALLY \$50.00 WORTH OF GRINDING WHEELS

Abrasive discs, felt and buffing wheels, mandrels, rotary files sheets, etc.

The buy of a lifetime! 327 pieces including 35 ass't. Grinding and Cut-off wheels up to 10 inches diameter, 1/16 to 1 1/4 in. face, 1/8 to 3 in. holes. Assorted grits—all brand new—made by Norton, Carborundum, Macklin, Bay State, etc. Also included are 100 slotted disc cloths; 100 paper discs; 3 round wire brushes on handles; 2 felt bobs; 2 felt wheels; 1 4" rag buff; 3 honing stones; 10 abrasive sleeves; 10 mounted stones, 1/8 and 1/4 shank; 2 mandrels; 2 rotary files, 1/4 shank; 50 abrasive discs; 2 72" abrasive belts; 5 9x11 abrasive sheets. Satisfaction guaranteed. Order today.

327 PIECES
ASS'T. SIZES
FOB CHICAGO
\$6.95
ALL FOR ONLY

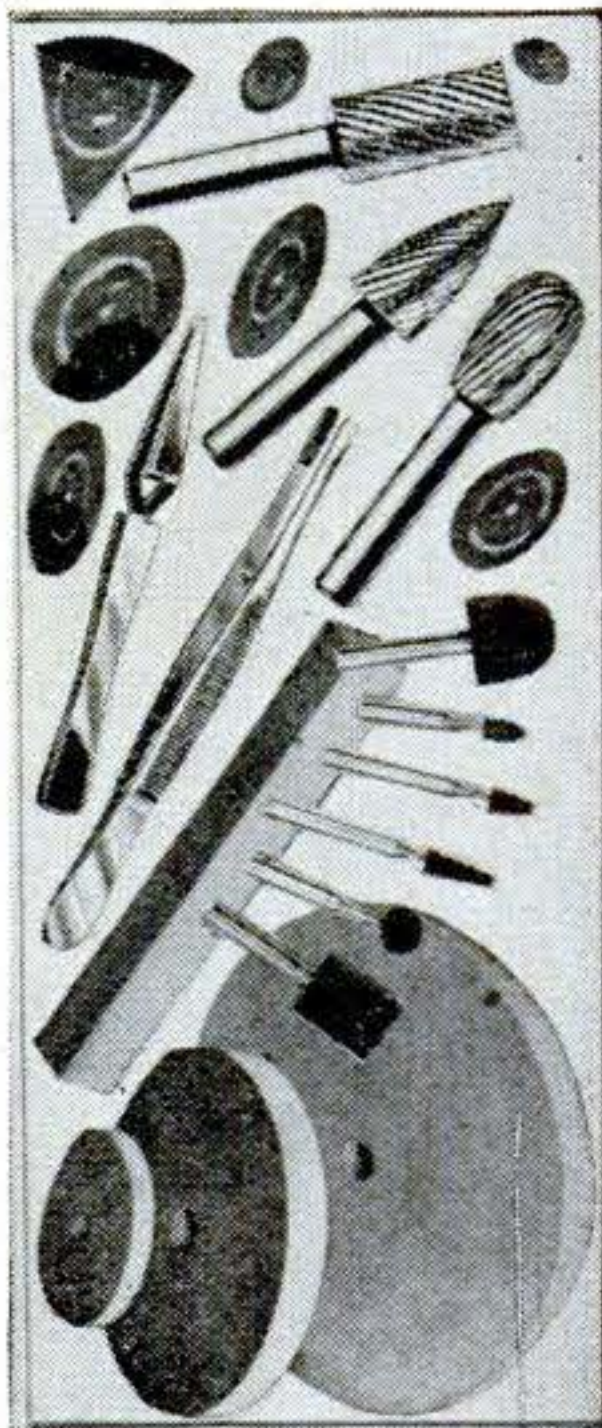

USE THIS HANDY ORDER COUPON

Groban Sup. Co., Dept. P512 Date.....
1522 So. Michigan Ave., Chicago 5, Ill.

Enclosed find \$.....for items checked below.

- () 41 Piece Grinder Ass't. @ \$4.95
- () 152 Piece Assortment @ \$8.95
- () 327 Piece Assortment @ \$6.95

NAME.....
ADDRESS.....
CITY.....STATE.....

SEND FOR THIS FREE!

Make money with horses. Every farmer, every lover of horseflesh should have a copy of this booklet. If you want to know how to break, train and make money with horses, write today for full information FREE, together with my special offer of a course in Animal Breeding. If you are interested in Galting and Riding the saddle horse check here. Do it today—now. You'll never regret it.

BEERY SCHOOL OF HORSEMANSHIP
Dept. 5812 Pleasant Hill, Ohio

LEARN TO DRAW & PAINT

LANDSCAPES, PORTRAITS, FIGURES, ANIMALS.
No Previous Training Necessary

IF YOU LIKE TO DRAW YOU HAVE TALENT. YOU CAN DEVELOP THAT TALENT THROUGH OUR HOME STUDY COURSE. LEARN TO DRAW AND PAINT IN YOUR SPARE TIME. WRITE FOR INFORMATION.

JOHN CLINTON ART INSTITUTE, Inc.
STUDIO C PALM BEACH FLORIDA

BE A REAL ESTATE BROKER PAYS BIG!

EASY TO LEARN—Start and run your own business quickly. Many graduates report making up to \$1000 a month. Course of study covers Sales, Property Management, Appraising, Loans, Mortgages and hundreds of related subjects. Course offered in home study or classroom—Both G. I. Approved. Send post card today for big, new illustrated book from this nationally known school. Dept. PC

WEAVER SCHOOL OF REAL ESTATE, 15 E. Pershing Road, Kansas City 8, Mo.

FREE BOOK TELLS HOW

STAY HOME AND MAKE MONEY!

—Men! Women! Get into profitable, uncrowded profession you can operate from your home or small office after short home training course. No capital required. No goods to buy. No age limit. Others earn \$50.00 to \$100.00 per week making famous Stephenson corrective foot devices to order. Foot sufferers everywhere pay gladly for relief. Send today for FREE BOOKLET.

STEPHENSON METHOD, Established 1894, 12-62 South Market St., Boston, Mass.

Say You Saw
It In Popular Science

Thrilling Work COLORING PHOTOS

Fascinating vocation learned at home by those with aptitude. Thrilling pastime. National method brings out life-like colors. Free booklet.

NATIONAL PHOTO COLORING SCHOOL
1315 S. Michigan, Dept. 1369. Chicago 5

\$

AGENTS SIGN LETTERS

300% Profit

For Store Fronts and Office Windows. Anyone can put them on. Free Samples. Liberal Offer to general agents.

METALLIC LETTER CO., 441 N. Clark, Chicago 10

CLEANS WINDOWS WITHOUT WATER

NEW CHEMICAL MITT

Sensational! DRY Window Cleaner! Uses no water, no messy liquids. Chemically Treated. Simply glide over windows; leaves glass sparkling clear. No heating water, no heavy buckets to carry. No rags, powders, sponges, cham-ois. No mess or muss. No red chapped hands. Dust, dirt, grime, fog disappear like magic. Wonderful for auto windows, windshields!

SAMPLES FOR AGENTS Sample offer sent immediately to all who send name at once. A penny postal will do. SEND NO MONEY—just your name. **KRISTEE CO., 695 Bar Street, AKRON, OHIO**



HELLO BOYS!

Erector is the world's greatest toy... crammed with real engineering features.

A.C. Gilbert

Founder, Gilbert Hall of Science

Famous ERECTOR

THEY WHISTLE

Made of **STEEL** to Build like **REAL**

BUILT WITH NO. 8 1/2

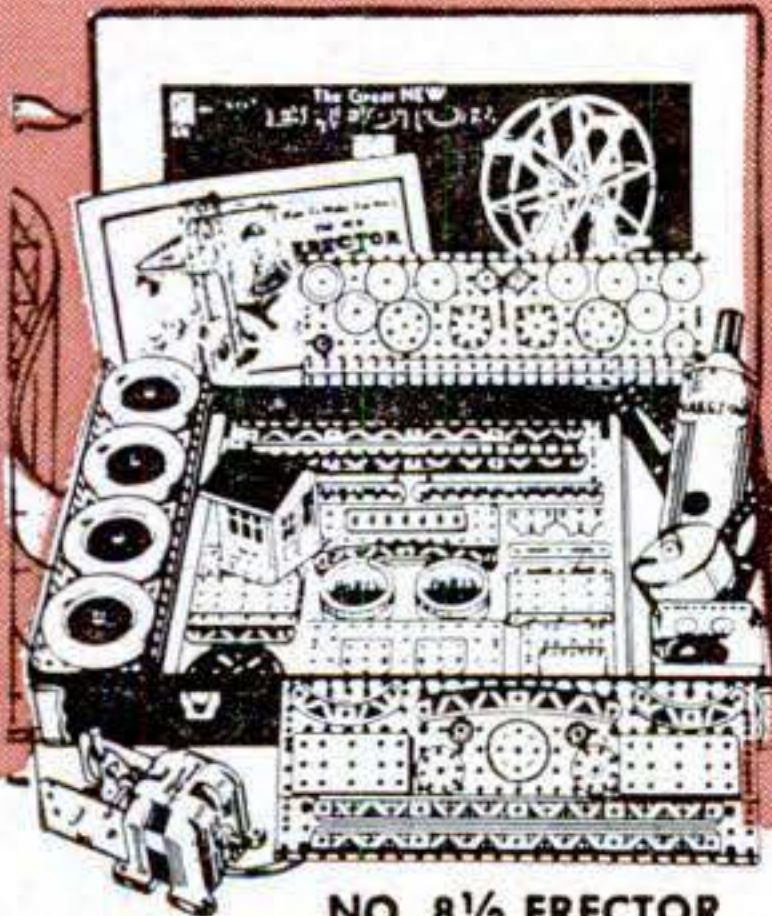

NO. 8 1/2 ERECTOR

THEY'RE ALL ELECTRIC

BUILT WITH NO. 9 1/2

IMPORTANT
The U. S. Patent Office has issued over 100 patents covering special Erector features.

THEY BUZZ WITH ACTION

BUILT WITH NO. 9 1/2 ERECTOR

LOOK at that towering Erector parachute jump. It's 5 feet high! With your own hands you fit the gleaming steel girders together—attach the rigging for the four 'chutes—and install the powerful Erector reversing engine.

Now for a sensational sight! Throw the engine into gear... and your parachutes are hoisted up and up until they strike the release mechanism. Then, like a flash, they plummet down—unfold—and lazily float to the ground.

Now get a load of that mighty Ferris wheel. It operates in either direction at high or low speed.

Think of the fun of building and running that giant power plant—with boilers, 12-inch flywheel and other parts all made of genuine steel.

You can build hundreds of spectacular mechanical marvels with *one* Erector set. No other construction set contains so many different parts. And how the Erector reversing engine makes them buzz with action!

FUN with Erector starts the moment you start to assemble girders, wheels, gears and other parts. No blueprints are needed. Erector parts have equi-distant holes, so that you only have to count the holes to put them together.

OTHER GILBERT SCIENTIFIC TOYS

- ★ AMERICAN FLYER TRAINS
Watch 'em puff smoke—hear 'em choo-choo
- ★ GILBERT CHEMISTRY LABORATORIES
The kind that bring boys fame and big awards
- ★ GILBERT POLARIZING MICROSCOPES
- ★ GILBERT ELECTRICAL SETS
- ★ GILBERT TOOL CHESTS

ONLY ERECTOR HAS ALL THESE FEATURES

- ★ Builds the square girder with interlocking edges
- ★ Erector girder is a structural girder—not just a perforated strip
- ★ Curved, straight and giant structural steel girders for realism
- ★ Equi-distant holes in base plates and girders for fast, precision building
- ★ Metal base plates with every set
- ★ Genuine bolts and nuts patterned after those used in real engineering construction
- ★ Tooth gears, crown gears, mitre gears, worm gears and pinion gears
- ★ Wheels, radiator, axles and other automotive parts
- ★ Engineer's shack
- ★ Steel boiler and giant flywheel parts for building realistic engines
- ★ Electric lights
- ★ Electro magnet
- ★ 110-volt reversing electric engine with gear shift
- ★ 135 different precision engineering parts



FREE

"Fun and Action with Gilbert Scientific Toys"

The A. C. Gilbert Company
315 Erector Square
New Haven, Conn.

Rush free illustrated broadside describing all Erector sets and other Gilbert Scientific toys.

Name.....
Street.....
City..... State.....

(Offer good only in U. S. A.)

When in New York visit the famous Gilbert Hall of Science, Fifth Avenue at 25th Street. Admission Free.

Startling
WAR SURPLUS Bargains!

Navy work
JACKETS

BRAND NEW Made of 8 oz green her ringbone twill 2 large patch pockets Ideal utility or overall jacket **\$1.69**

Genuine NYLON
PARACHUTE CORD

550 lb. tensile strength Ideal for clotheslines, venetian blind or drapery cords. Each hank contains over 50 feet of cord 3/16 inch thick. **59¢**

15,000 PR. Surplus O.D. wool serge PANTS



\$2.95

YES, LESS THAN THE COST OF THE CHEAPEST OVERALL 100% pure wool serge Absolutely perfect condition Cleaned and pressed by the Q M Corps. These trousers were designated for reissue. Sizes 28 to 36.

Send for our **FREE** **WAR SURPLUS CATALOG**

Surplus Navy
FIELD JACKETS



\$3.99

SIZES 36 to 42
BRAND NEW. Here's an ideal utility jacket. Made of olive drab water repellent poplin material. Two slash pockets, full zipper front. Unlined.

Military Style
WATCHES
17 JEWEL



\$24.95 PLUS 10% FED. TAX

THE GREATEST WATCH VALUE IN THE U. S. Save \$15.00. 17-jewel, stainless steel water resistant case, anti-magnetic, radium dial, sweep second hand. If it isn't the best value you have ever seen return it for a refund.

MAIL ORDERS

Please enclose remittance with order. Include approximate postage. If you desire we will ship C.O.D. (plus postage and C.O.D. fee). SEND FOR OUR WAR SURPLUS CATALOG. OVER 150 SURPLUS ITEMS.

aviators style
SUN GLASSES

The type the aviators wore. 24 karat gold plated metal rim. Ophthalmic ground lenses, 4 base curve. We sold thousands at \$6.00 each. Now only **\$2.99**

SIoux FALLS SURPLUS STORE
113 NO. PHILLIPS
SIoux FALLS S.D.

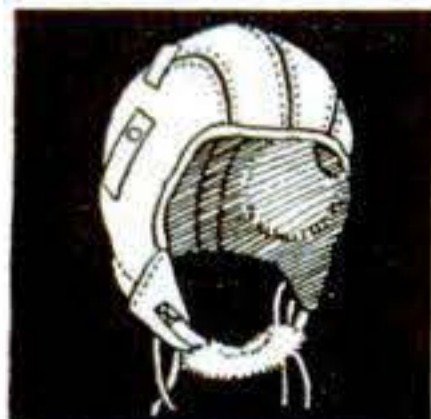

2 FOR ONLY \$1.00

AAF FLYING HELMETS

New—Fleece Lined Muffs and Chin Straps

FREE—AAF OXYGEN MASK—NEW

Mail only \$1.00—All above items shipped immediately postage collect.

FORTUNE & SHAW

2250 McKinley

Fresno, Calif.

\$9.95 TAKES ALL THREE BIG BARGAINS

1. AUDIO AMPLIFIER. Undreamed of value. Uses 6V6's. Has 4 microphone inputs brought to jacks at rear panel. Various output impedances available at rear panel connections. Steel case with chrome handles. 9" long x 9" high x 6" deep. Tubes included. New in original carton. Shipping weight 15 lb. SUPER SPECIAL—\$4.95 while supply lasts.

2. RADIO HEADSETS. Latest supersensitive type with rubber earpieces. Every pair guaranteed perfect. \$.59 per pair OR 3 PAIRS FOR \$1.00.

3. HOME WORKSHOP AT BARGAIN PRICE. Accurate and precise 2 speed guaranteed hobby lathe, the essential machine for the home workshop. Sturdy enough for light production work or factory standby service. Supplied with 56" of belting for connecting to any available electric motor or power take-off, such as on a jeep or tractor. Also included in this unbelievable offer are such accessories as a 1/2" drill chuck with specially hardened tool steel jaws, a 4" electric furnace high speed grinding wheel, a cotton buffing wheel with a large supply of buffing compound, and a 4" steel wire scratch brush. Your cost \$6.00. Sole export agent. Distributor inquiries invited.

ORDER NOW—DON'T DELAY—NO C.O.D.s

BUFFALO RADIO SUPPLY 219 Genesee St. Buffalo 3, N. Y.

The SPEED SAW FILER

Saves You Time, Money



Now FILE YOUR OWN SAWS

Now you can do expert saw filing at home. Lifetime tool makes precision filing easy for even the most inexperienced. Two simple adjustments make it fit any type hand saw. Keep your saws extra sharp and true-cutting with a Speed Saw Filer. Complete with file, ready to use. Money back guarantee. Cash with order, prepaid (C.O.D. postage extra.)

THE SPEED CORP.
2025-B N.E. Sandy, Portland 12, Ore.

ORDER NOW! **\$2.95**

PLASTIC SUPPLIES

Plexiglas, Lucite, Sheets, Rods, Tubes, Cement Dyes, Buffs, Equipment, Etc. Lowest prices. Send 3c stamp for catalog. **PLASTICS MFG. & SUPPLY CORP.,** Dept. PS-12, 4707 Euclid Ave., Cleveland 3, Ohio.

HOW TO BUILD YOUR OWN CABIN!

Here's an amazing new book that shows you complete detailed plans for building your own log cabin, bungalow, hunting lodge, etc.! 256 big pages, 180 diagrams give step-by-step directions for laying foundation and floors—building fireplaces, chimneys, porches, garages—shingling roofs—cutting doors, windows, shutters—yes, even for installing plumbing and electricity without expensive hired help! A big money-saving bargain at ONLY \$1.98!

YOURS FOR 7-DAY FREE TRIAL!



Order this astonishing 256-page book now for 7 days' FREE trial! On delivery pay postman only \$1.98 plus postage—then use it for a whole week FREE! If not delighted, return for full refund. Address:

OUTDOOR LIFE, Dept. 127A
353 Fourth Avenue, New York 10, N. Y.

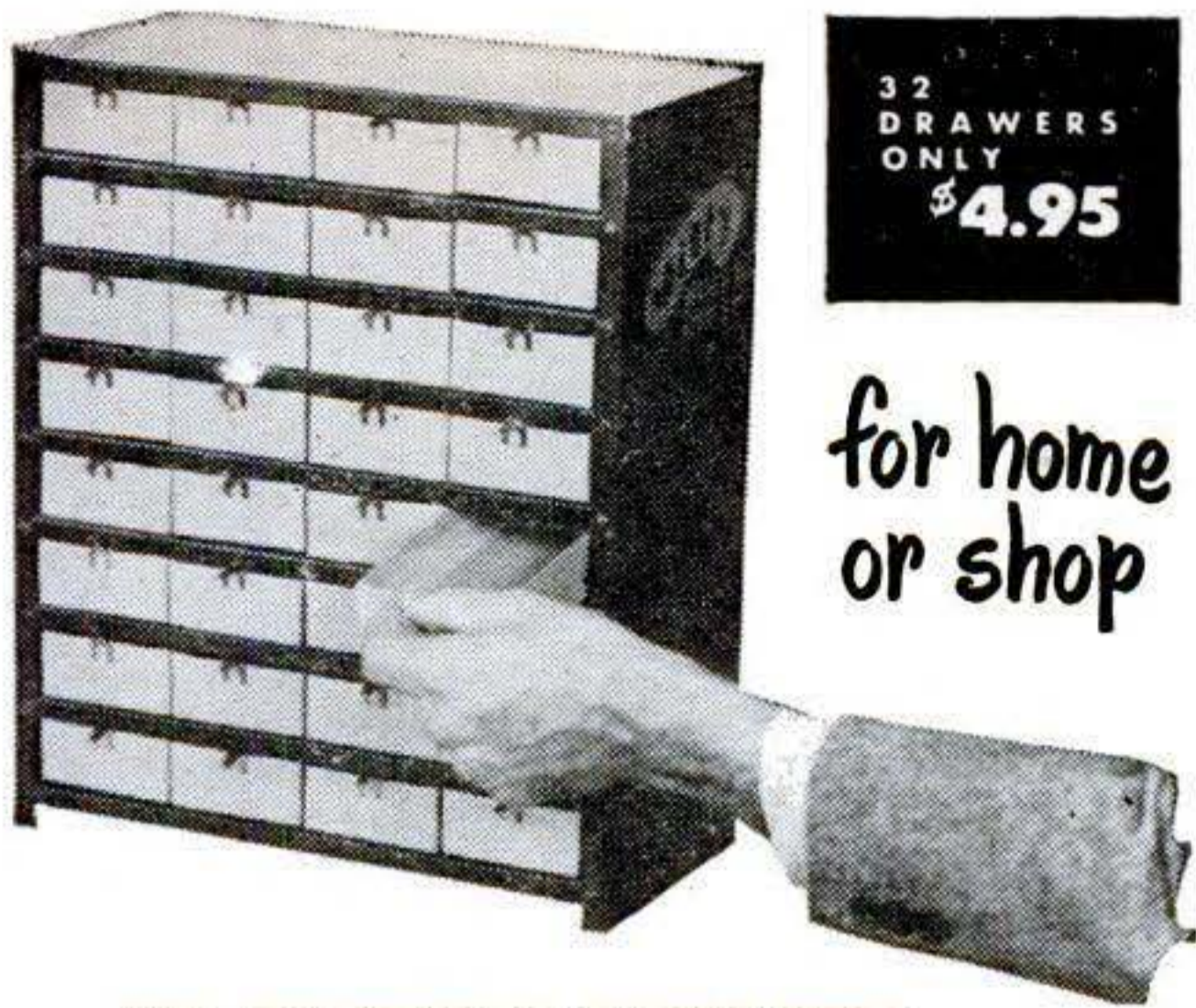

for home
or shop

THE JIFFY CABINET

THE HANDY WAY TO KEEP SMALL PARTS, WASHERS, NAILS, SCREWS, NUTS, BOLTS AT HAND

Sturdy
all metal
cabinet

DRAWERS
1 1/4" Deep
3" Wide
6" Long

Here's the smart way to keep small items in your shop or at your work bench—The Jiffy Cabinet: holds 32 or 64 spacious, sturdy drawers that put small parts at your finger-tips. Metal flange drawer guides. Solidly built all metal cabinet insures long time-saving service. Why fumble? With the Jiffy you know where it is—you can get it in a hurry. 32 drawer size—\$4.95; 64 drawer size—\$7.95 postpaid. Send check or money order—no C.O.D.'s please.

KAYTEE PRODUCTS

Box #588 • Canton, Ohio

Learn MASONRY CARPENTRY



In a few short weeks you can be making big money in the building trades. Learn now while opportunities are greatest. Prepare for the future. You receive your training in our completely equipped shops under expert instructors. Fully approved for G.I. Training.

MIDWEST SCHOOL OF BUILDING TRADES
Dept. A-212 411 N. Center Street Bloomington, Ill.

Wonders Through The

MICROSCOPE



A new book which tells you all about MICROSCOPY. Turn an inexpensive microscope on hundreds of specimens within a stone's throw of your front door and you step off into a new world of wonders. Complete Manual for amateurs. How to use equipment, secure specimens, take photomicrographs, etc. Numerous illustrations. Full cloth bound \$1.49 DeLuxe.

POPULAR SCIENCE MONTHLY, Dept. 127
353 Fourth Ave. New York 10, N.Y.

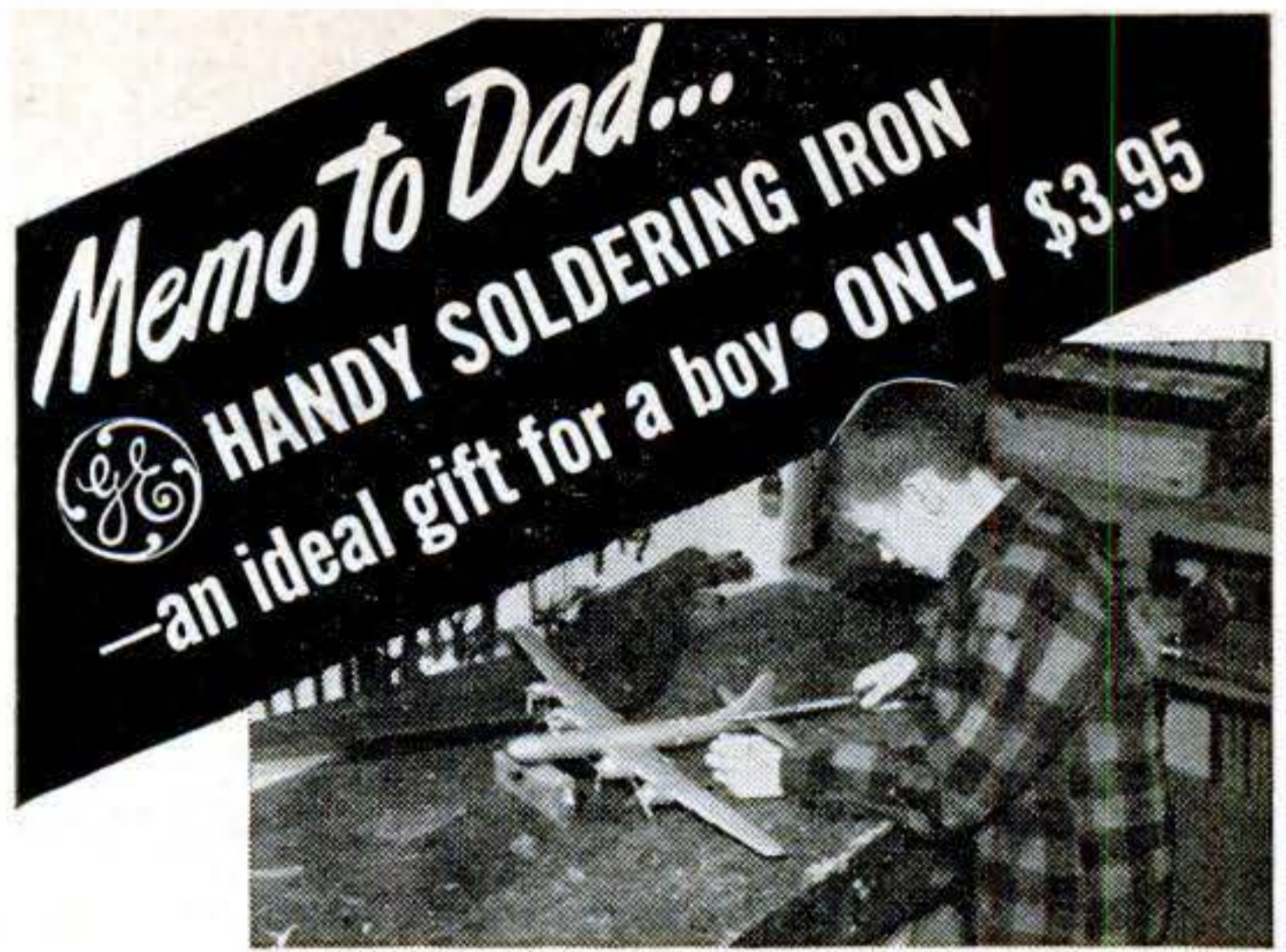

You can't find a better gift for that mechanically minded boy of yours. For the G-E Handy iron is lightweight, sturdy, easy to use—perfect for the boy who likes tools. He'll get countless hours of use and enjoyment from it.

And, to help your boy solder, a booklet on "How to Solder" is packed with every iron.

Get him a G-E Handy soldering iron at your dealer's. Or order direct, giving the name of your dealer. Apparatus Dept., General Electric Co., Schenectady 5, N.Y.

GENERAL ELECTRIC

667-5

EARN MORE

\$\$\$ \$ \$



SEND FOR THIS **FREE** BOOK NOW!

• Increase your earning power. Become thoroughly trained in a well-paid profession. Without obligation, find out about the opportunities in Electrical, Mechanical, Plastics, Civil, Mining and other engineering fields. Our free 118-page handbook, lists details of home study courses, compiled by world authorities. See for yourself how you can soon earn more dollars. Write today, to: Canadian Institute of Science and Technology, Ltd., 437 Century Building, 412, 5th Street, N.W., Washington, D.C.

Details of over 60 home study courses
based on standard textbooks
MAIL THIS COUPON NOW

Canadian Institute of Science & Technology, Ltd.,
437 Century Building, 412, 5th Street N.W.,
Washington, D.C.

Please forward free of cost or obligation of any kind your 118-page handbook "Engineering Opportunities".

Name..... Age.....

Address

CANADIAN ENQUIRIES: 219 Bay Street, Toronto 1.

WAR SURPLUS

STANLEY SUPER-VAC MADE FOR U. S. NAVY

America's finest Lifetime Vacuum Bottle. Sold everywhere before the war at \$7.95. Not yet generally available at stores. We have BRAND NEW NAVY SURPLUS 1 QT. SIZE. Unbreakable steel liner. Handsome black finish. Heavy chromium plated screw top. Perfect for sportsmen, workers, hunters, fishermen, etc. It's an outstanding value. Don't miss it!

QT. SIZE
\$5.95
Plus 25c for postage & handling



17 JEWEL WRIST WATCH SERVICE PRECISION WATCH DESIGNED for AIR CORPS SWISS MOVEMENT-INCABLOC

- WATERPROOF
- SHOCKPROOF
- SWEEP SECOND HAND
- RADIUM DIAL
- STAINLESS STEEL BACK
- LEATHER STRAP

BRAND NEW • FULLY GUARANTEED
\$19.95 A Regular \$50.00 Value

Add 10% Fed. Tax plus 25c postage and insurance

ALLIED SALES CO.

DEPT. 5D • 523 MISSION ST. • SAN FRANCISCO 5, CALIFORNIA
Send check or money order. Sorry no C.O.D.s.

IDEAL XMAS GIFT

FREE

Send for free catalogue. Has many marvelous WAR SURPLUS BARGAINS.

BUILD THIS AUTHENTIC SCALE MODEL MIDGET RACE CAR

THE NEW **SPORT-O-SPEED** JET POWERED

Only **\$2.50** COMPLETE Per Kit

Add 15c for postage

Redesigned for jet power, three view plans—details clearly illustrated. All parts rough cut from balsa. Overall dimensions, length 9 inches width 4 inches.

This fast moving midget racer features: rubber tired metal wheels—knerfing bars—bumpers—hand brake—steering arm—etc.



SPORT-O-SPEED, Dept. A, 520 Lotus Road, Ridgewood, N. J.

WOO-WEE AUTO HORN Wolf Whistle

Reproduces "Wolf Whistle" better than any siren. Screeches, barks, whistles, imitates siren, moves any "road hog" off the highway in "double quick plus." Attract more attention than by driving a yellow Cadillac. Operates from manifold. Installed on any car in 15 minutes. Sturdily constructed. Cleverest novelty since the use of the auto. Be the first user in your neighborhood. Dealers wanted. Absolute money back guarantee. 6 dollars each. Order today Ohio orders add 3% tax.
THE PROTECTUROD COMPANY—Dept. 102
4033 Windsor Road - Youngstown 7, Ohio



WAR SURPLUS POWER PLANT GENERATOR

110 VOLT • 60 CYCLE • 2500 WATT
WEIGHT 200 LBS LIST PRICE \$276.00

NEARLY NEW 110-volt single phase 60 cycle A-C generator. Exactly like commercial power. Self-excited. No other equipment required. Fine for ranchers, taverns, sportsmen. Generate your own electricity. Powerful portable plant. (Complete except engine.) Small engines easy to pick up or you can use water or wind power. Fine stand-by power for farms. Contractors use for on-job power saws, drills, etc. Full instr. installing, using. Guaranteed perfect. Order now or write for details.

LECO ENGINEERING CO., Box 908 PS-F, Lincoln, Nebr.

Statement of Ownership, Management, Circulation, etc., required by the Act of Congress of August 24, 1912, as amended by the Acts of March 3, 1933, and July 2, 1946, of Popular Science Monthly, published monthly at New York, N. Y., for October 1, 1947, State of New York, County of New York, ss. Before me, a notary public in and for the State and county aforesaid, personally appeared Godfrey Hammond, who, having been duly sworn according to law, deposes and says that he is the Publisher of Popular Science Monthly and that the following is, to the best of his knowledge and belief, a true statement of the ownership, management, etc., of the aforesaid publication for the date shown in the above caption, required by the Act of August 24, 1912, as amended by the Acts of March 3, 1933 and July 2, 1946 (Section 537, Postal Laws and Regulations), printed on the reverse of this form to wit:

1. That the names and addresses of the publisher, editor, managing editors and business manager are Publisher, Popular Science Publishing Co., Inc., 353 Fourth Avenue, New York 10, N. Y.; Editor, Perry Githens, Managing Editors, Fred O. Newman and Volta Torrey, Business Manager, Godfrey Hammond, 353 Fourth Avenue, New York 10, N. Y. 2. That the owners are: Popular Science Publishing Company, Inc., 353 Fourth Avenue, New York 10, N. Y.; Stockholders of Popular Science Publishing Company, Inc., Mansell and Company, 45 Wall St., New York 5, N. Y.; Oliver B. Capen, Capeswold, Bedford Village, N. Y.; Noreen S. Capen, Capeswold, Bedford Village, N. Y.; Robert Cade Wilson, 683 Springfield Avenue, Summit, N. J.; Ada B. Wilson, 683 Springfield Avenue, Summit, N. J.; Marguerite N. Cole, Round Hill Road, Greenwich, Conn.; Kay Brown, Box 624, Westport, Conn.; Irma V. Hammond, 163 Brewster Road, Scarsdale, N. Y.; Helen B. Glennon, 50 Howell Ave., Larchmont, N. Y. 3. That the known bondholders, mortgagees and other security holders, owning or holding 1 percent or more of the total amount of bonds, mortgages, or other securities are: none. 4. That the two paragraphs next above giving the names of the owners, stockholders and security holders, if any, contain not only the list of stockholders and security holders, as they appear on the books of the company but also, in cases where the stockholder or security holder appears upon the books of the company as trustee or in any other fiduciary relation, the name of the person or corporation for whom such trustee is acting, is given; also that the said two paragraphs contain statements embracing affiant's full knowledge and belief as to the circumstances and conditions under which stockholders and security holders who do not appear upon the books of the company as trustees hold stock and securities in a capacity other than that of a bona fide owner, and this affiant has no reason to believe that any other person, association, or corporation has any interest direct or indirect in the said stock, bonds, or other securities than as so stated by him.

(Signed) Godfrey Hammond, Business Manager.

Sworn to and subscribed before me this 1st day of October, 1947, Esther Eyl, Notary Public, Kings County, Kings Co. Clerk's No. 51, Registry No. 70-E-8, New York County Clerk's No. 126, Registry No. 62-E-8. (Seal) My Commission expires March 30, 1948.

Now for EVERY WORK SHOP!

NEW Invention Electroplates by BRUSH

Easy to Plate CHROMIUM GOLD, SILVER, NICKEL, COPPER ... For Pleasure and Profit!

If you have a workshop—at home or in business—you need this new Warner Electroplater. At the stroke of an electrified brush, you can electroplate models and projects—you can replat worn articles, faucets, tools, fixtures, silverware, etc. with a durable, sparkling coat of metal... Gold, Silver, Chromium, Nickel, Copper or Cadmium. Method is easy, simple, quick. Everything furnished—equipment complete, ready for use. By doing a bit of work for others, your machine can pay for itself within a week. So make your shop complete by getting a Warner Electroplater right away. Send today for FREE SAMPLE and illustrated literature. ACT AT ONCE! Mail Coupon.
WARNER ELECTRIC CO., DEPT. P-6
1512 Jarvis Avenue, Chicago 26, Ill.



FREE Details & Sample!

WARNER ELECTRIC CO., 1512 Jarvis Avenue, Chicago 26, Dept. P-6

Gentlemen: Send Free Sample and Details to:

Name _____

Address _____

City _____ State _____

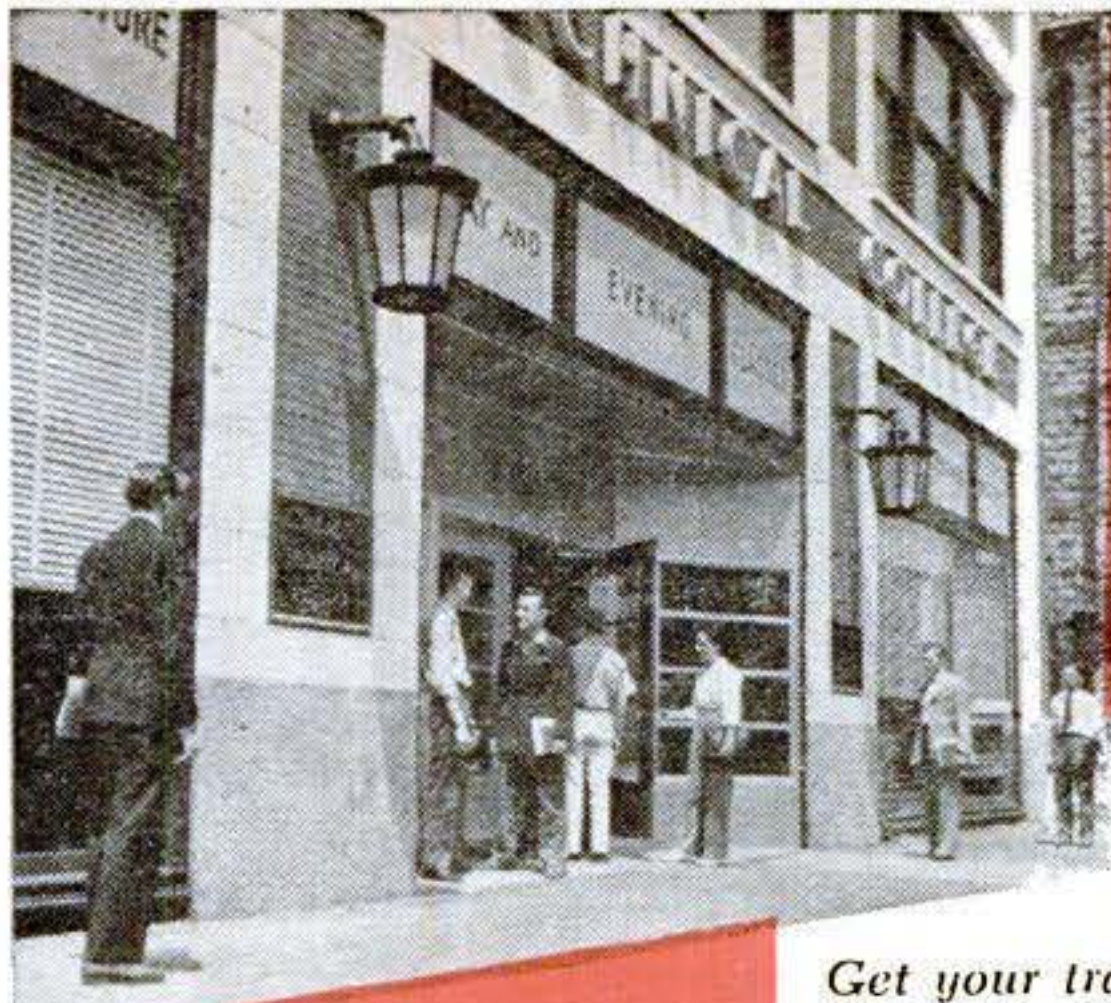

Learn ENGINEERING DRAFTING... BUILDING in Chicago, Industrial Hub

Approved For G. I. Training Time-Saving Courses Day & Evening Classes

Get your training at Chicago Tech in the Nation's industrial center. Chicago provides unequalled opportunities for part-time employment while training and for permanent positions upon graduation. Many other cultural and recreational advantages described in Catalog,—sent Free!

Chicago Tech, founded 43 years ago, has trained thousands of men now occupying important places in industry the world over. Training combines theory and practice in 1 year, 2 year, and 3 year (Degree) courses. Saving in time means earlier graduation,—and consequently earlier employment.

Terms start January, April, July and October. Get information now to arrange for early admission and accommodations.

**CHICAGO
TECHNICAL COLLEGE**
S-86 Tech Bldg.
2000 So. Michigan Ave.
Chicago, 16, Ill.

**1 YEAR • 2 YEAR
3 YEAR COURSES**

**BUILDING
DRAFTING
ENGINEERING
AIR CONDITIONING
REFRIGERATION
ELECTRICITY
RADIO**

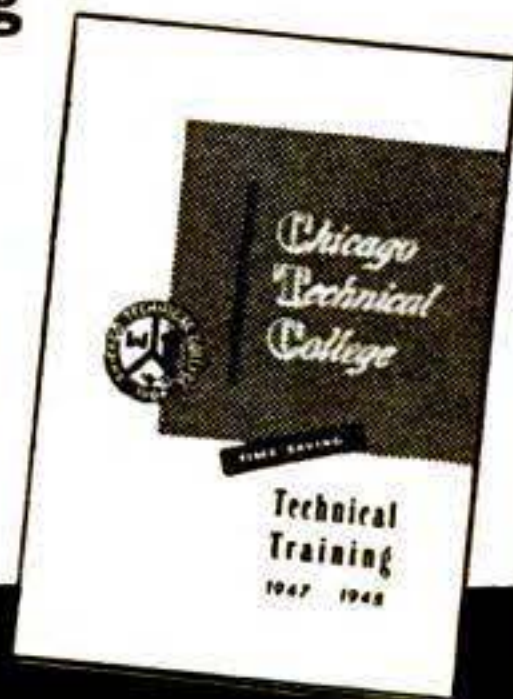

MAIL COUPON TODAY

Chicago Technical College
S-86 Tech Bldg., 2000 So. Michigan Ave.
Chicago 16, Ill.

Please send me without obligation free booklet on Time-Saving Technical Training.

Name..... Age.....

Address.....

City..... Zone... State.....



Learn modern watch and clock repairing

At home, spare time. Good field now... security and contentment in future. Start part-time business and EARN while you learn. Horology is precision instrument work... a great and growing field. sensational opportunities. Easy self-instruction course. Full price.

only \$4.95. SEND NO MONEY. Just pay postman, plus C.O.D. postage. Or send \$4.95 with order, we'll ship postpaid. Satisfaction guaranteed or refund.

NELSON - HALL CO.
1139 S. Wabash Ave. Dept. MO1 Chicago 5, Ill.

**Say You Saw
It In Popular Science**

TOOL STEEL DRILL ROD

\$3.50
POSTPAID
in Continental U.S.
C.O.D.'S ACCEPTED

9-18" Bars **SAMPLER KIT** 9 Sizes

Ground and Polished to a Perfect Finish

1001 uses for Craftsmen, Hobbyists, Mechanics, Etc.

For Making
Punches
Chisels
Engraving
Tools
Shafts, Etc.

Free machining, easily worked, yet can be made file hard or hardened to spring temper. Hardening instructions included!

FREE
With first order 6" steel comb. rule & depth gage with pocket clip and latest price list.

FLAT TOOL STEEL

The Precision ground flat tool steel with the satin-smooth finish. Simple to work, easy to harden, ready to use.

SHOP ASSORTMENT—\$4.80

(5 dif. Pieces—1/32" to 1/8" thick; 1/2" wide; 18" long)

BOTH KITS—\$7.95

(Include 25c postage on orders under \$5.00)

We can supply ALL your Tool Steel Needs.

BESSEMER STEEL COMPANY OF AMERICA, Dept. CD-12
Small Shops Division, 1958 W. 59th Street, Chicago 36, Illinois

INSTALL DUAL WHEELS IN LESS THAN 10 MINUTES

On your Trailer, Pick-up Truck, Farm Wagon or Jeep
with STANDARD WHEELS

In less than ten minutes, at an amazing low cost, you can now convert your vehicle to dual wheels. We've eliminated the expense of changing your wheels and hubs, or changing the entire axle. All you need is a rim wrench to install dual wheels yourself. DUAL WHEEL CONVERTERS are guaranteed to do the job or your money back. At your equipment dealer or write to Northwestern Auto Parts Co., 834 N. 7th St., Minneapolis 11, Minn.

ONLY **\$28.50**
COMPLETE SET

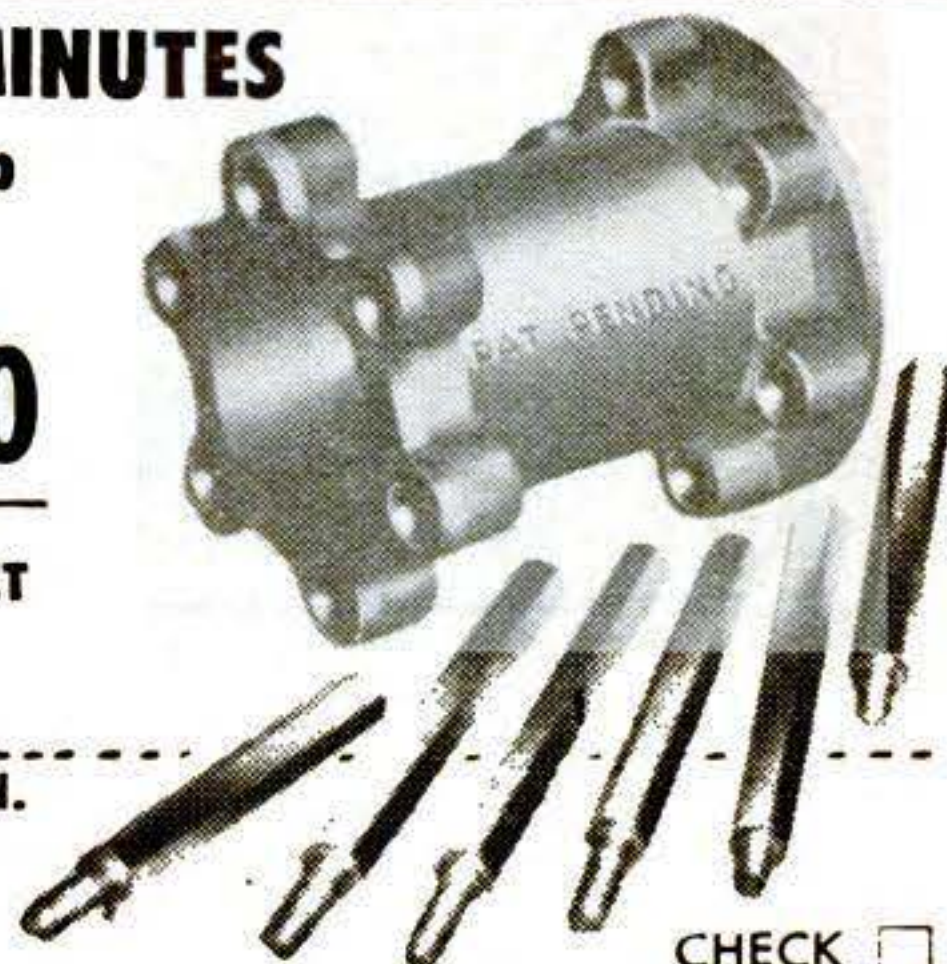

MAIL COUPON TODAY FOR YOUR DUAL WHEEL CONVERTERS

NORTHWESTERN AUTO PARTS CO., 834 NO. SEVENTH ST., MINNEAPOLIS 11, MINN.

Please send me _____ Dual Wheel Converters at \$28.50 each. 12

FORD CHEV DODGE-PLYM JEEP

NAME _____ ADDRESS _____

CHECK
MONEY ORDER

"Funster"

The New Amazing 20 way-play HOME GYM SET
FOR INDOORS OR OUTDOORS **BUILD IT YOURSELF** OF WOOD

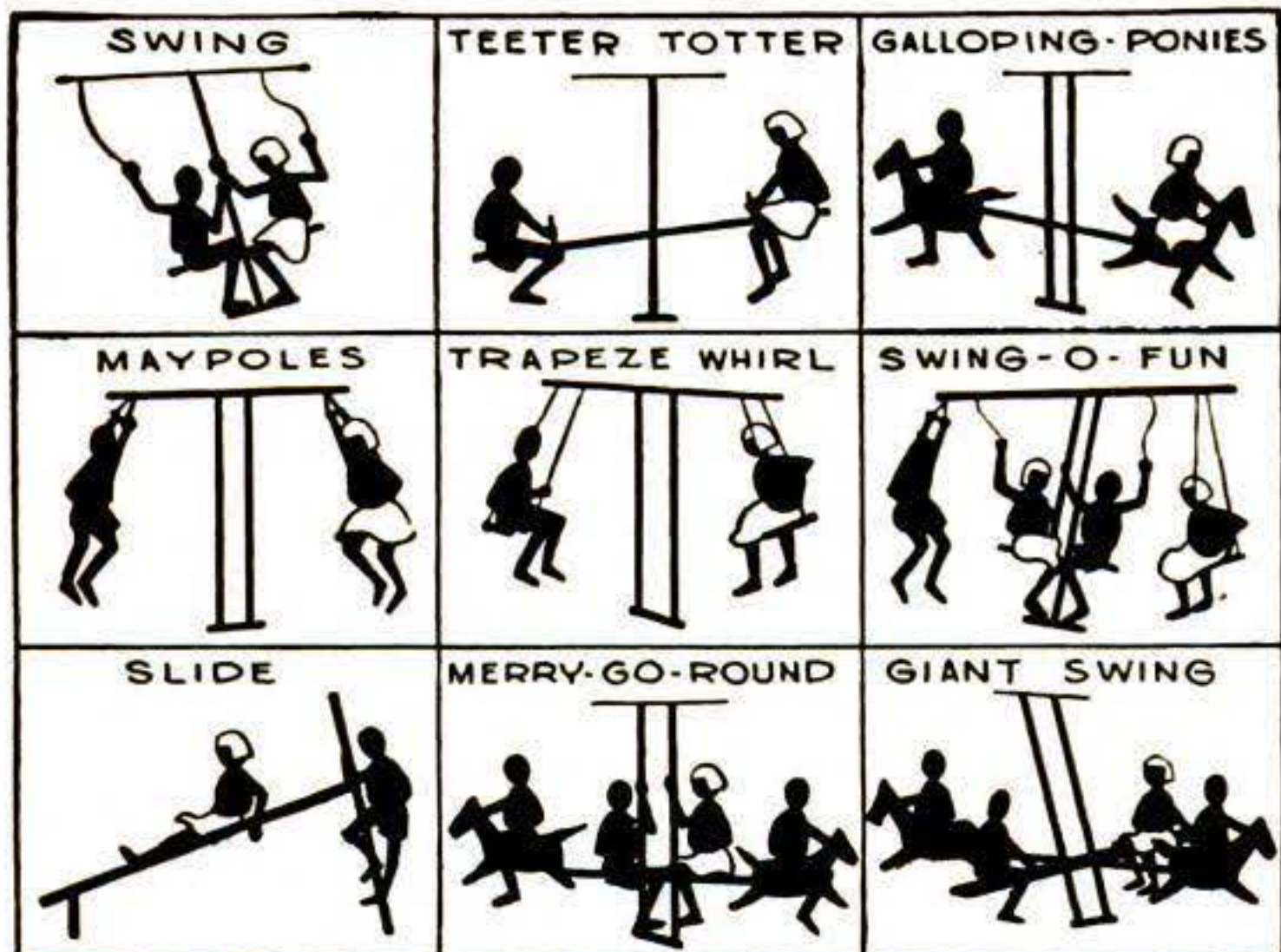

The unit includes, besides these illustrations, a chair-plane scoot-a-round, gym bar and various combinations of play thrills. ALL PARTS ARE INTERLOCKING AND REQUIRE ONLY FROM 10 TO 50 SECONDS TO CONVERT FROM ONE PLAYTHRILLER TO ANOTHER.

An Ideal Xmas Gift For All The Children

Twelve sheets of pictures with drawings and instructions for all twenty ways for ONLY **\$2.00** SEND FOR YOURS NOW

HIGHLAND MFG. CO.

Cor. Garfield & 4th Highland, Indiana

THE RIGHT GIFT for a PIPE SMOKER

- ★ Windproof
- ★ Lightweight
- ★ Large Flame

DOWN-DRAFT CHIMNEY ACTION

\$3.50 AT YOUR DEALERS

Nimrod Unconditionally Guaranteed

PIPELITER

If your dealer is unable to supply you send \$3.50 direct
WARD-NIMROD COMPANY
Dept. 36-H, 2968 Jessamine St., Cinti. 25, Ohio

**POLISHES!
SANDS! GRINDS!
CURVED & FLAT**

**SURFACES - FASTER -
EASIER!** Works with any
1/4" Electric
Power Drill,
Flexible Shaft.

You Can Use It To:
Fix Bodies, Fenders;
Wax, Polish Cars, Floors, Linoleum;
Refinish Furniture, Wood, Metal
Surfaces; Smooth, Reduce Welds; etc.

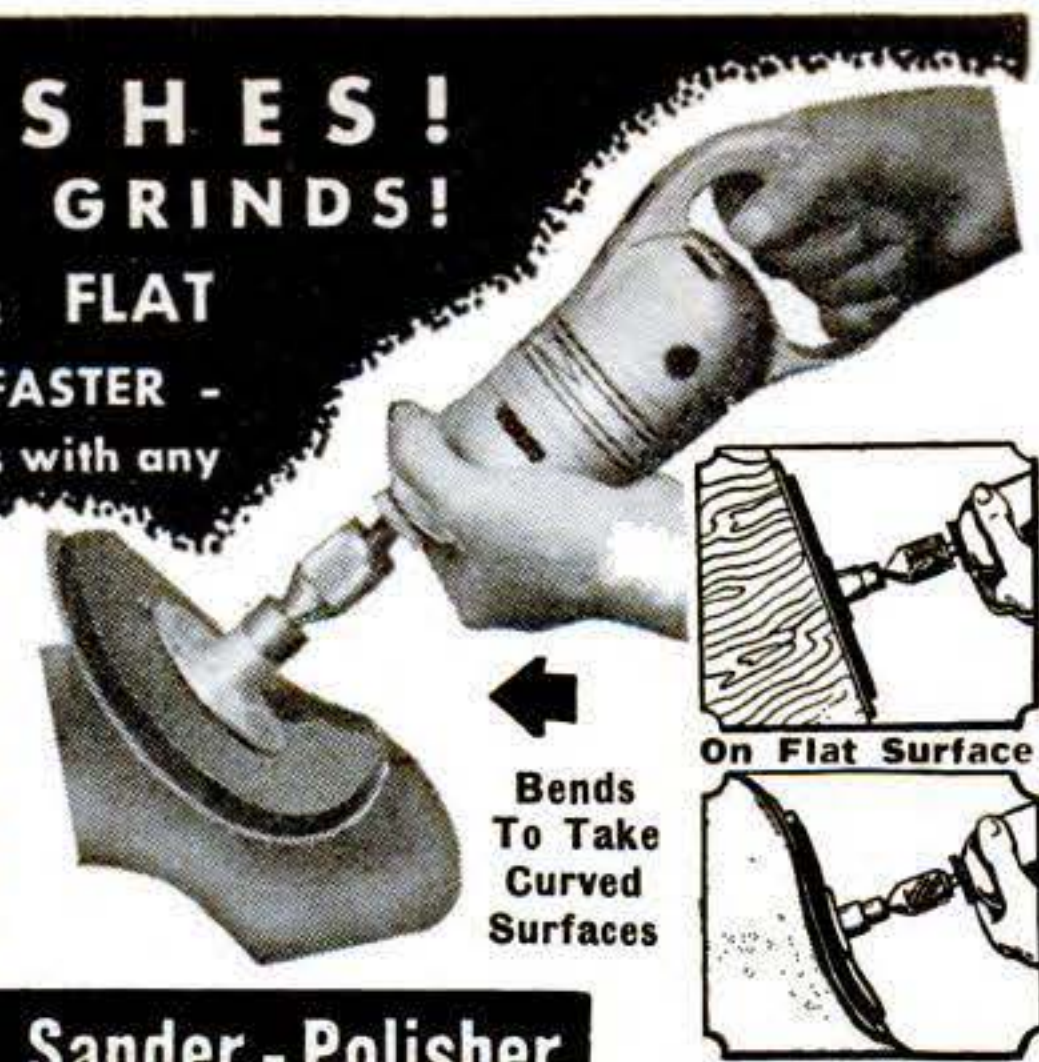

Bends To Take Curved Surfaces

On Flat Surface

On Curved Surface

NEW FLEX Sander - Polisher

Works with your electric drill, flexible shaft or chuck equipped motor. Speeds up all grinding, sanding and polishing jobs—fits any 1/4 inch chuck. Rubber face plate flexes into curves for fast, smooth, clean work. Outfit includes 6 1/2 inch rubber disc, with metal flange and shank, fibre backed sanding disc, and heavy sheep's wool polisher. Makes your drill the equal of any \$75.00 grinding or polishing outfit. Satisfaction guaranteed. **\$4.95**

Order today. F.O.B. Chicago. Only.....

DEALERS WRITE

PREHLER PROVED PRODUCTS

Division Norbert Prehler & Co. Dept. PS12, 1623-5 Milwaukee Ave. Chicago 47, Ill.

RADIO PARTS GRAB BAG!!

Over 200 different parts originally valued at \$50.00 including a wide assortment of transformers, coils, condensers, resistors, sockets, controls, etc. A perfect collection for the radio experimenter. Send check or M.O. today.

\$3.98

A \$50.00 VALUE!

MARKO SUPPLY

Dept. P2-R, 2924 Logan Blvd. Chicago 47, Ill.

HOTTER GAS TORCH

100% PRIMARY AIR KELLER GAS TORCH. **\$3.45**
Burns Regular House Gas (Natural Gas Only)—No Compressed Air, No Adjusting Needed—Develops 2100°F.
Guaranteed to silver solder, light brazes, solders, removes paint rapidly.
Precision-engineered. 1500 B.T.U. per hour.
Order today C.O.D. from
KELLER GAS APPLIANCES
P. O. Box 261 Monrovia, California

Jiffy Jr. BOILING HOT WATER IN A JIFFY!!

ELECTRIC HEATER

Place the Jiffy Electric Water Heater into the water and insert the plug in the nearest electric wall or light plug. You will have hot water in less than five minutes for baby's bath, your washing, shaving and a great many other uses in the home, camping, business, and on the farm. Mailed complete, including six feet of rubber covered wires and plug. One year guarantee. **JIFFY ELECTRIC COMPANY, Dept. S1, 21321 Stephenson Highway, Hazel Park, Mich.**

Only **\$2.95** HOT WATER IN A JIFFY
plus twenty five cents for postage

Say You Saw
It In Popular Science

ALUMINUM PANS, BOXES, CONTAINERS

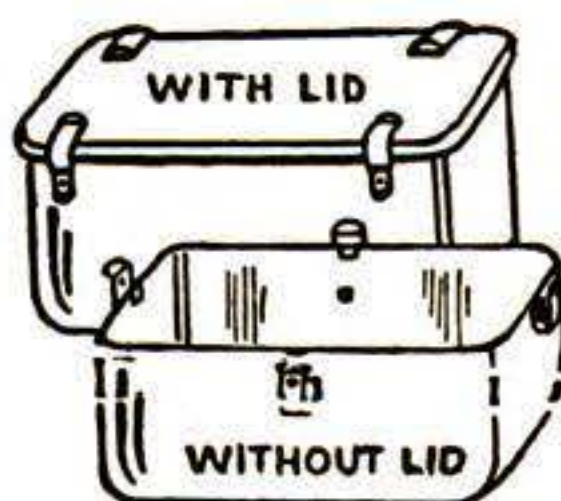

9 DIFFERENT SIZES

Non-Rusting, last a lifetime. Furnished with a snap on tight fitting lid. Suitable for fisherman, hunters, campers, homes, for storing small articles or cooking. For Deep Freeze units, any liquids. 1,000's of uses. Sizes from 7 1/2" x 5" x 1 1/2" to 18" x 10 1/4" x 3 1/2"

Price from 39c to \$1.39

Price FOB. K.C.—write for descriptive circular

MIDWEST BUY ANYTHING CO.

1520 Locust St. Kansas City, Mo.

WAR SURPLUS BARGAIN SPECIAL CENTRIFUGAL PUMP READY FOR USE ON ANY LIQUID PUMPING NEED

USE IT FOR
HOME
WATER
SYSTEMS

•
IRRIGATION

•
STOCK
WATERING

•
FIRE
PROTECTION

•
DRAIN
BASEMENTS,
PONDS,
TANKS, etc.

•
INDUSTRIAL
PUMPING

A super value for all types of intermittent service in pumping large volumes of liquid in home, farm and industrial service. Ideal for home water systems, draining basements, fire protection, etc. On the farm for watering stock, draining ponds, sprinkling, etc. In shops and factories for all types of pumping service.

MOVE LARGE VOLUME QUICKLY

When operated at 1750 RPM, will pump 42 gallons per minute on a 23 foot head; at 3600 RPM on 52 foot head will pump 88 gallons per minute. May be run with electric motor, gas engine or power take-off on tractor.

COMPLETE WITH PULLEY AND MOUNTING BRACKET — READY TO INSTALL

Pump has cast aluminum housing—accurately machined bronze impeller vanes. Complete with mounting bracket and 3 1/2 inch V belt pulley. Shaft rotates on sealed ball bearings with grease gun fitting. Has 1 1/2 inch threaded intake flange, two 1 inch outlets. Use one or both as necessary. Made for Packard Motor Car Co. for use in Rolls-Royce Merlin Aircraft engines. Comes complete with pulley and mounting bracket.

GREATEST PUMP VALUE IN YEARS

Original cost approx. \$147.00. Sold F.O.B. Chicago. Shipping weight 23 pounds. Complete engineering reports and operating instructions free with pump. You can't beat this pump value at anywhere near this price. Satisfaction guaranteed.

Original Cost Approx. \$147.00

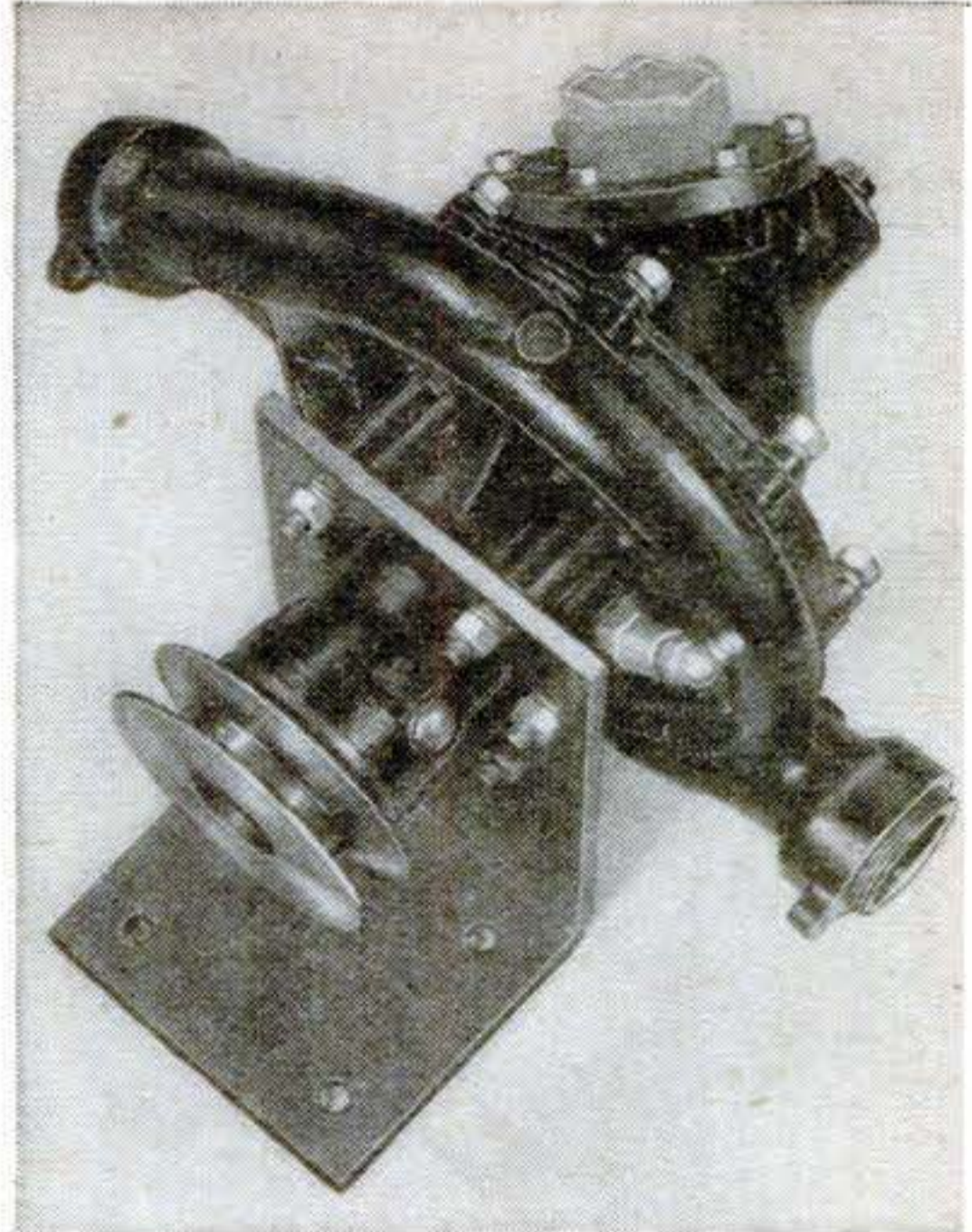

COMPLETE
WITH
PULLEY
AND
MOUNTING
BRACKET—
READY
FOR USE

\$29.75
F. O. B.
Chicago

GROBAN SUPPLY CO. Dept. PS12 1522 So. Michigan Ave., Chicago 5, Ill.

I N V E N T O R S

Highest ROYALTIES and CASH

FOR INVENTIONS
When We Market Them

INVENTION MARKETING SERVICE "UNPARALLELED" BY ANY OTHER AGENCY IN THE WORLD

Write for FREE booklet without obligation

UNIVERSAL MARKETING CO., 126 Lexington Ave. (Suite C-12), New York 16, N. Y.

DRAW for MONEY... Be an ARTIST!

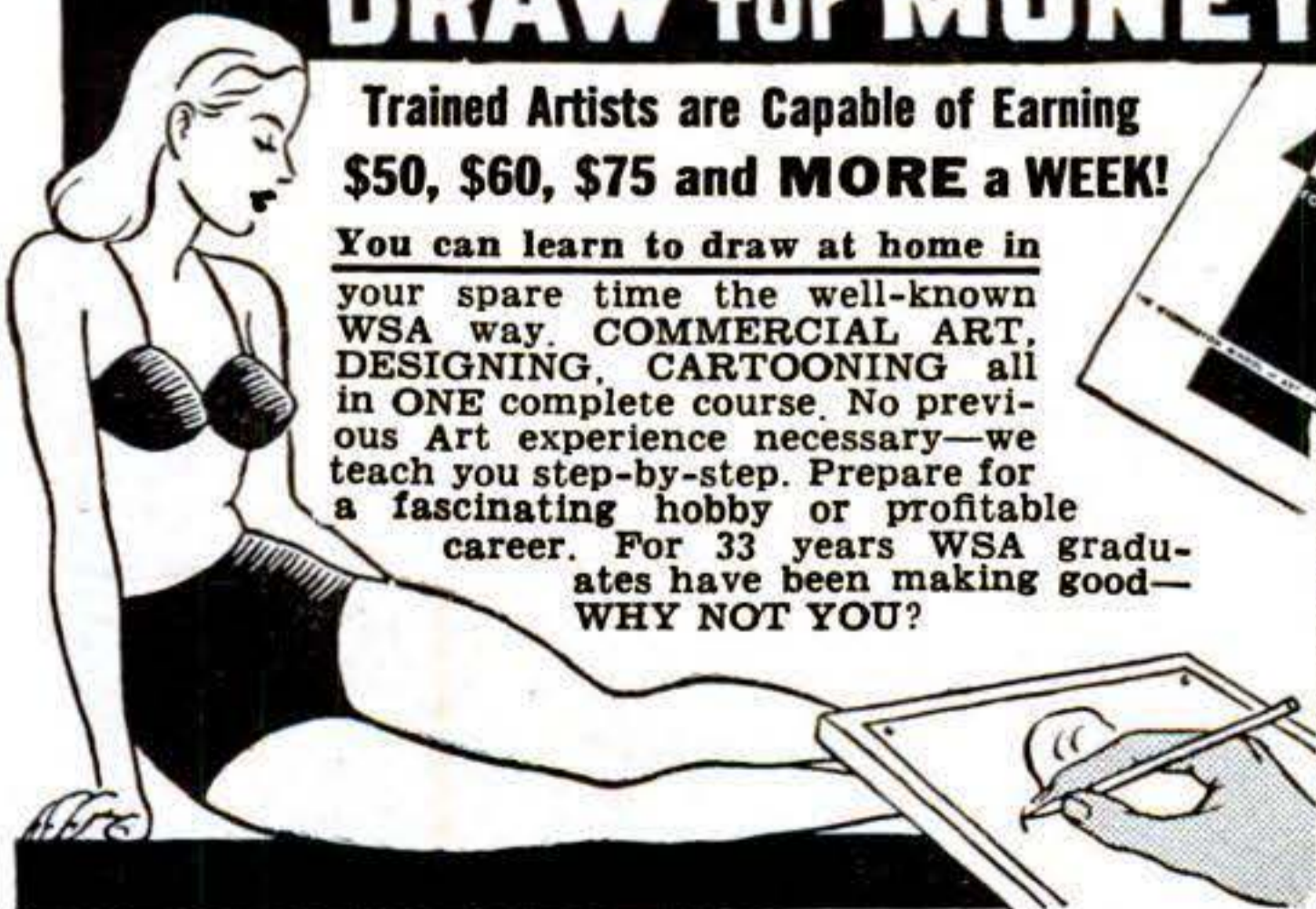

Trained Artists are Capable of Earning
\$50, \$60, \$75 and MORE a WEEK!

You can learn to draw at home in your spare time the well-known WSA way. COMMERCIAL ART, DESIGNING, CARTOONING all in ONE complete course. No previous Art experience necessary—we teach you step-by-step. Prepare for a fascinating hobby or profitable career. For 33 years WSA graduates have been making good—**WHY NOT YOU?**

VETERANS! WSA Approved for Training Under G. I. Bill. Write for FREE BOOK, "Art for Pleasure & Profit", fully describes course, our method of instruction and commercial opportunities for you. TWO ART OUTFITS included with training.

Washington School of Art, Studio 1312H
1115—15th St., N.W., Washington 5, D. C.

Please send me full information and your Free Book, "Art for Pleasure and Profit."

Name.....AGE.....

Street

City..... Zone..... State.....

I am entitled to training under "G. I." Bill.

NOW! EXTRAORDINARY New GOV'T RELEASE!

Shoots A High Pressure Stream Of 30 Feet!

ALL PURPOSE STIRRUP
PUMP
ONLY \$1.49
EACH

The Tool of 100 Uses!

- Just the thing for
- FIRE FIGHTING. A very handy tool to have in your workshop in case of fire.
- Spraying Garden
- Washing Cars
- Bailing Boats and Basements

Finest quality all purpose pump on the market! Never before offered at this ridiculously low price. There are dozens of uses for this versatile sprayer. Approximate height 27" overall. Complete with 10 feet of flexible hose, ready for assembly. SEND NO MONEY: Simply send name and address and number of pumps desired and we will promptly mail your order C.O.D. plus 25c for postage. If you prefer send \$1.49 plus 25c for postage with order.

S & B SURPLUS SALES CO., Dept. PS10
2905 W. Madison St. Chicago 12, Ill.



a small investment will
establish you in . . .

Your OWN Business

We are NOW enlarging our organization of U.S.A. and Canadian DURACLEAN dealers, in territories still open. Here is an opportunity to BE YOUR OWN BOSS . . . to become financially independent with a business of your own! You become a fabric specialist, providing the proper cleaning and moth protection for upholstery and floor coverings. You use the proven, successful methods of established dealers. Service is rendered right in the home, office or institution without removing furnishings.

DURACLEAN Service was established 17 years ago as an improved method for cleaning and revitalizing rugs and furniture. No harsh machine scrubbing, no soaking or shrinking. No inconvenience for the customer.

DURAPROOF makes fabrics and rugs repellent to moths, carpet beetles and mildew.

These services have a waiting market . . . a big repeat business. Write today! A letter and 16 page illustrated booklet will explain everything.

- No Overhead Expense
- You Learn Quickly, Easily
- No Shop Necessary
- Short Hours . . . Large Profits
- No Experience Needed
- Service Nationally Advertised

Don't delay! Territories are limited. Remember, just a moderate payment, easy terms, and the opportunity to become financially independent in YOUR OWN BUSINESS!
DURACLEAN CO., 18-D St., Deerfield, Illinois



Write For
FREE
Booklet



- Test ALL Home Outlets
- Find Open Circuits

STAR TEST-PLIERS

- Locate Blown Fuses
- Remove Fuses SAFELY

A must tool for electricians, maintenance men, home owners. Replaceable lamp inside Plier tests 110 to 250 Volts. Plier pulls fuses from 10 to 100 Amperes. Shockproof. Requires the use of only one hand. Can be obtained from General Electric or Westinghouse stores, or from local electric dealers.

A Useful Xmas Gift

Price \$2.75 without Leads, \$1.50 additional for Leads. Order TODAY.
STAR FUSE CO., 237 Canal St., New York 13, N. Y.

now you can easily make this

Gorgeous Garden Lamp



● Project Headquarters helps craftsmen get the right materials for the construction of home projects. Beautiful plant lamp shown here was first illustrated on page 136, Popular Science, October 1947 issue. Kit of materials for this lamp, now available at only \$4.95 postpaid. Kit includes .020 brass sheet for base, (cut to size), wiring sockets, brass tube, washers, nuts, ornaments, plans (everything but shade). Tools required are tin snips, soldering iron, hammer and file. A good craftsman can produce this lamp, \$45.00 value, in one evening. Send \$4.95, check or money order. (We can furnish materials for most projects in this issue.)

**PROJECT Headquarters
of AMERICA**

Materials and Plans

Only \$4.95 Post Paid

Dept. P-1, 1756 Henderson St. Chicago 13, Ill.



GIRLS, BOYS You'll Enjoy Painting With Colored Sand!

Complete only \$2.25 postpaid. If west of Rockies or Canada add 25c.

Miraculous Sand Pen does amazing works of art. Easy to do. Get this handsome Gift Box 19 x 11 containing complete set with 5 tubes and 12 boxes of colored sand, a bottle of special adhesive, brush and 12 outline pictures, ready for "Sand Painting." If your dealer can't supply, mail coupon. Write for Catalog of other items.

AMERICAN TOY & FURNITURE CO.

6130 N. Clark Dept. 2127 Chicago 26, Ill.

MAKE EXTRA MONEY

Draw cartoons at home! Learn how to draw cartoons in 10 EASY lessons . . . learn where and how to SELL them, rates of pay, how to approach big magazines and syndicates. Many other valuable tips. Send only \$1.00. Act NOW!

EASY CARTOONS, 4305 CROWN ST., INDIANAPOLIS 8, IND.



YORK FOOT SWITCH

- Frees both hands.
- Increases efficiency in the operation of machine tools.
- Completely encased in a skidproof rubber case 2 3/4" in diameter.
- 15 Amps., 125 Volts.
- Assembled complete with a 7 Ft. UL approved cord and tap.

Sold by leading machine tool and photography dealers throughout the U. S., or order direct from factory. Price \$3.95, sent prepaid anywhere in the United States.

FARNSWORTH PRODUCTS CO.

Dept. 400
1409 E. Madison St. Seattle, Wn.

Now

YOU CAN HAVE IMPROVED NO-DRIFT FM
in the Sensational New 1948
MIDWEST RADIOS

NEW SERIES
16*
SUPER DELUXE
AM-FM
CHASSIS

14 1/2"
PANASONIC
SPEAKER



5
WAVE
BANDS

Here is the finest radio Midwest has ever produced in its 28 years of manufacturing—a world-ranging, 5-band radio with improved Midwest No-Drift FM . . . plus Standard Broadcast and 3 short wave bands, Television Audio Switch-over, and Color-Ray Tone Selection. The Series 16* Super De Luxe Chassis is a powerful, magnificently-toned radio that challenges comparison for performance, sensitivity, selectivity, and advanced engineering features. Supplied with satin stripe copper finish panel—ready to mount in your present cabinet. Send today for the FREE 1948 Midwest Radio Catalog. Buy your radio direct from the manufacturer on Easy Terms and 30 Days Trial and SAVE!

*Series 16
 CHASSIS USES ALL THESE
 LATEST-TYPE TUBES,
 RECTIFIER AND TUNING INDICATOR

30
DAYS
TRIAL

LOW
FACTORY-
TO-YOU
PRICES

EASY
TERMS

A COMPLETE LINE OF FINE RADIOS AND RADIO-PHONOGRAPHS . . . Available in Separate Chassis Like the Powerful Series 16* AM-FM Model above, or in beautiful Radio-Phonograph Consoles like this:

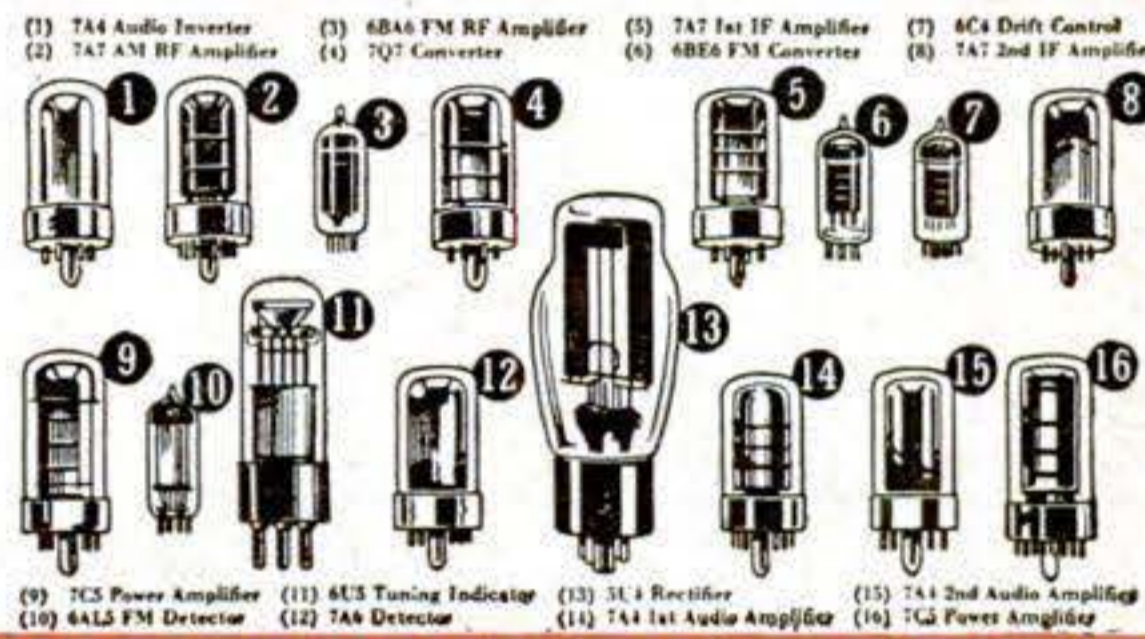

Scores of NEW Features such as the Exclusive MIDWEST TRI-MAGNADYNE COIL SYSTEM and COLOR-RAY TONE SELECTION



SYMPHONY GRAND AM-FM
RADIO-PHONOGRAPH CONSOLE
 with NEW Intermix **AUTOMATIC**
RECORD CHANGER

Our Finest! A superbly beautiful musical instrument . . . a masterpiece of furniture design and radio engineering that offers the sensational Midwest NO-DRIFT FM, Automatic Intermix Record-Changer, Exclusive Color-Ray Tone Selection, World-ranging 5-Band Reception, Television Audio Switch-Over, and many more new and exclusive features.

Rush for Free Catalog!
 FILL IN COUPON AND MAIL TODAY OR JUST
 SEND YOUR NAME AND ADDRESS ON 1c POSTCARD

MIDWEST RADIO CORP.
 Dept. 24-P, 909 Broadway
 Cincinnati 2, Ohio

Gentlemen: Please send me your new FREE catalog and details of your liberal 30 Days Trial.

Name.....
 Address.....
 City..... Zone..... State.....

MIDWEST RADIO CORP.
 Dept. 24-P • 909 BROADWAY • CINCINNATI 2, OHIO

A PROFITABLE TRADE! AN EXCITING HOBBY!



Learn... **PHOTO
NEGATIVE
RETOUCHING**

This new home-study course will teach you how to improve your pictures . . . how to impart that "professional finish." And don't forget that photo negative retouching is a fine profession for both men and women . . . a profitable business that you can conduct from your own home.

This complete copyrighted course of lessons on Retouching, Modelling, Etching, Collecting, and Spotting is priced at only

\$17.50

GIVEN AT NO EXTRA COST with each course is all the equipment you need, consisting of:

- RETOUCHING STAND
- RETOUCHING PENCILS
- RETOUCHING DOPE
- SPOTTING BRUSH
- ETCHING KNIFE
- CHINESE SPOTTING INK
- EMERY CLOTH

—and a different assortment of PRACTICE NEGATIVES FOR EACH LESSON . . . also included is a PROOFING DEVICE AND PROOF PAPER to check your results!

SEND IN THIS HANDY COUPON TODAY!

Remember, if you are not completely satisfied and return the set in good condition within 5 days, you will receive a full refund.

PROFESSIONAL RETOUCHING by MARSHALL, Inc. School Division, Dept. PS-12, 162 N. State St., Chicago 1, Ill.

- I enclose \$17.50. Send course prepaid.
- Send course C.O.D. I'll pay postage.
- Send information and easy payment plan.

NAME _____

ADDRESS _____

CITY _____ ZONE _____ STATE _____

(ALL TRANSACTIONS BY MAIL ONLY!)

**Say You Saw
It In Popular Science**

PORTRAIT STUDIOS SAY IT'S TOPS

**NATIONAL 4x5
Cold Light
ENLARGER**

For Perfect Color and
Black & White Enlargements

\$99.50

LESS LENS

National's revolutionary features assure you consistently fine results. Professional photographers cite its color advantages.

Colonial, Dept. 32
25 State St., Detroit 26, Mich.

Please send me the National 4 x 5 Cold Light Enlarger at \$99.50.

- Full payment enclosed.
- Down payment enclosed.
- Send C.O.D.

Name _____

Address _____

City _____

**\$10
DOWN
\$10
A
MONTH
No Extra
Cost**



**NEW
LOW PRICE**

Takes all standard negative sizes from 35mm to 4" x 5"

**Mail Order
Shipped
Anywhere
in U.S.**



Every Small Business
Needs this **ADDOMETER**

ADDING MACHINE

only
\$12.95

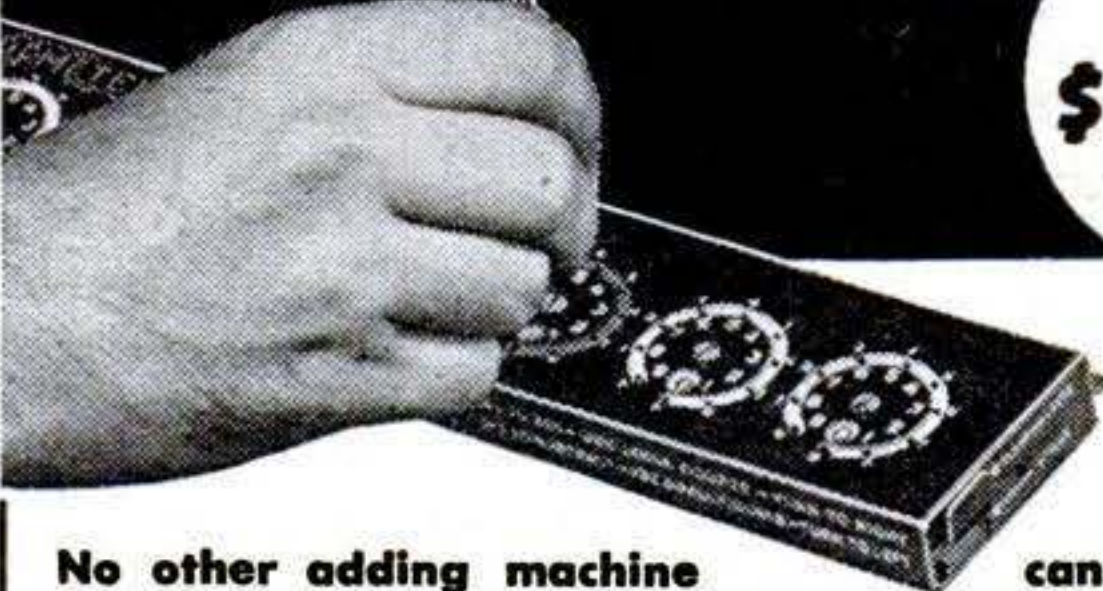

No other adding machine can match all its advantages! Adds, subtracts direct, multiplies—quickly, accurately. So easy to operate—no practice necessary. The perfect portable—11½x2½ in. size, weighs only 14 oz. Eight-column (\$999,999.99) capacity models also to handle fractions, feet and inches. Over 100,000 in use—praised everywhere. Only \$12.95 postage prepaid—10 day money-back guarantee if not fully satisfied. Complete descriptive folder on request—or, send check or money order NOW.

Reliable Typewriter & Adding Machine Co.
Dept. F-12, 303 W. Monroe St. Chicago 6, Ill.

25c
Postage Paid
in U.S.A.

**The Original MOORE'S
Educational TOY MOTOR**

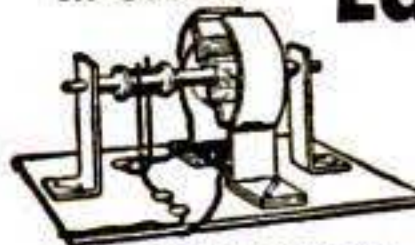

Patent 1857209

For twenty-five cents you get all parts necessary to build this electric motor, which will make over 6,000 revolutions per minute. It runs on a single No. 6 dry cell battery. Over 3,000,000 Moore Toy Motors have been sold. As an aid to teaching electrical science it is unsurpassed and has been purchased by many schools.

GEORGE W. MOORE INC., 88 Beaver St., Waltham, Mass.

HOW TO BUILD YOUR OWN CABIN!

Here's an amazing new book that shows you complete detailed plans for building your own log cabin, bungalow or hunting lodge! 256 information-packed pages and 180 diagrams tell you all about laying foundation, building walls, laying floors, shingling roofs. You'll even find step-by-step directions for building porches and garages; cutting doors, windows, shutters; building fireplaces and chimneys—yes, even installing plumbing and electricity without expensive hired help! An astonishing money-saving bargain at ONLY \$1.98!

YOURS FOR 7-DAY FREE TRIAL!

Order this big 256-page book now for 7 days' FREE trial! On delivery pay postman only \$1.98 plus postage—or \$2.48 for handsome Buckram-bound DeLuxe Edition. Use it a whole week FREE! If not delighted, return for full refund.



**ONLY
\$1.98**

MAIL FREE-TRIAL COUPON!

OUTDOOR LIFE, Dept. 127A
353 Fourth Avenue, New York 10, N. Y.

Send me **How to Build Cabins** in edition checked below:

- DeLuxe Edition Buckram, \$2.48
- Regular Edition Cloth, \$1.98

I'll pay postman price plus postage when book arrives. If not satisfied, I may return book within 7 days for full refund.

Name _____

Address _____

City _____ Zone _____ State _____

- Check here if you send payment with order, and we will pay shipping costs. Same refund privilege.

Home Owners - Hobbyists! Shops!

• An all metal-welded cabinet complete with 45 glass jars of four different sizes. Perfect for the homeowner who wants a neat shop in his cellar. Ideal for hobbyists and small shops for small parts. Immediate delivery. For the HOMEOWNER—MODEL 101—an open cabinet and 45 jars. 40 items of the most commonly used household items. \$19.50. Model 201—same as 101 except has doors—\$21.00. For hobbyists and shops—Model 100—open cabinet with 45 jars—no hardware—\$10.00. Model 200—same as 100 except has doors—\$11.50.

All Prices F.O.B.

GWILLIAM MACHINE & MFG. CO.

Dept. PSI

124 WASHINGTON STREET

BLOOMFIELD, N. J.

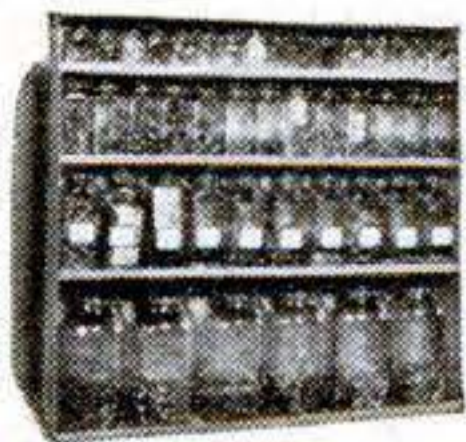

Our Finest Precision REBUILT MOTOR BLOCK ASSEMBLIES

Carries
the Same
**90 DAY
GUARANTEE**
As a New
Motor Assy.

Sold Outright or Exchange

Rebuilt by skilled mechanics. Assembly has Rebores Block with New Pistons, Pins, Rings, Reground Crankshaft, and all New Bearings. Guaranteed 90 Days.

Allowance on Old Motor

We ship at outright price. Send your motor prepaid, must be suitable for rebuilding. Send in notarized bill of sale showing title number if any. We refund difference when we receive your motor.



\$5.00
Crating
Charge

FORD BLOCK ASS'Y.			
Year	Type	Outright	Exch.
28-31	4 cyl.	\$ 98.00	\$73.00
32-47	6 & 8	139.00	89.00
Mercury			
39-47	V8	149.00	99.00
Chevrolet			
29-47	6 cyl.	117.50	87.50

DODGE—3 1/4" bore			
Year	Type	Outright	Exch.
35-47	6 cyl.	\$129.00	\$99.00

Plymouth			
Year	Type	Outright	Exch.
35-47	6 cyl.	129.00	99.00

Specify exact year, make and model when ordering. Send for catalog on motors not listed.

POWER TAKE-OFF for JEEP ENGINE

Bolts to clutch housing on the Jeep engine. Has a spline shaft to engage with clutch and extending from rear is a keyed shaft on



which pulley can be mounted. Hand lever controls clutch.
SF4N-23J—
Each.....

\$4250

NEW 5 Gal. CANS

FOR GAS, OIL OR WATER Vented for Safety. Self-locking Safety Cap Extra Heavy Construction Will Float When Full Size of can, 18" high, 6 1/4" thick, 13" wide. SA35U-60— Lots of 5, ea. 1.15 Lots of 50, ea. 1.05 Lots of 100, Each 98c



60 HP. JEEP Engines

Reconditioned, Tested and Guaranteed in perfect running order and ready to run. Every part is checked to be perfect and carries a 90 Day Guarantee same as a new engine. COMPLETE with . . . Generator, Starter, Distributor, Coil, Fan and Fan Belt, Water Pump, Fuel Pump, Intake and Exhaust Manifolds, Carburetor, Oil Filter, Spark Plugs, Flywheel, Clutch and Pressure Plate, and Wiring.



\$5.00
Crating
Charge

Outright, SG58R-003, Each \$13750

New Willys JEEP Enclosed Power Unit

60 HP. 4 cyl. engine 134.2 cu. in. displacement, 3 1/8" bore 4 3/8" stroke. Complete with radiator, gas tank, clutch power take-off with 1 1/2" keyed shaft, and all accessories. READY TO RUN, NEW, COMPLETE, SG60N-002—F.O.B. Chicago.

\$32500

SEND 25% CASH WITH ORDER, BALANCE C.O.D.

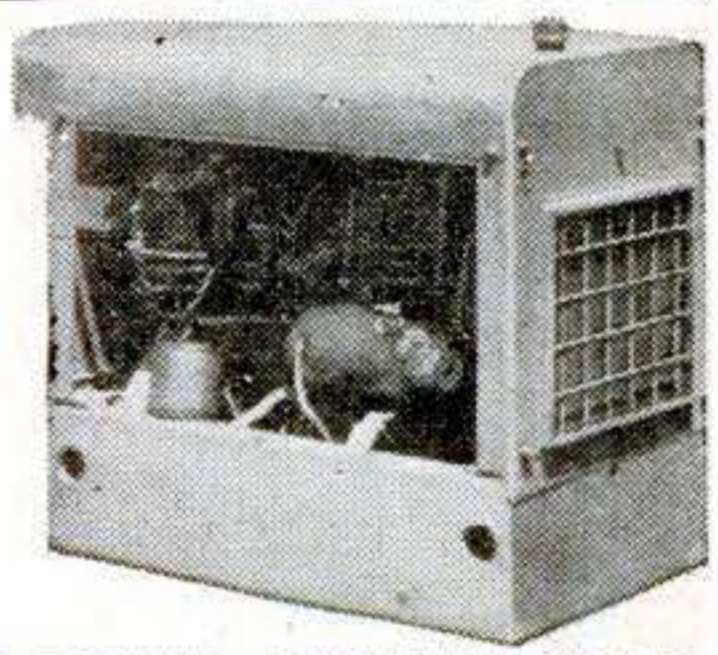

J.C. WHITNEY & Co.

1917 Archer Ave. Chicago 16, Ill.



FIELD JACKETS

A Super-value, fine poplin Army FIELD JACKET can be yours for only \$2.88. Quality features; full zipper-front, 100% blanket-lined, water repellent, adjustable hip straps. Ideal for Farmers, Lumbermen, Truck Drivers, Sportsmen. Although used, every jacket guaranteed perfect condition. Sizes 34 to 40. State size and send check or M.O. Supply limited. Hurry.

ONLY
\$2.88

Postpaid

MARKO SUPPLY, Dept. P2-J, 2924 Logan Blvd., Chicago 47, Ill.

TOY PISTOL—\$1.75 each postpaid

Beautiful Texan Repeater 10 1/4" Long. Nickel finish with Ivory handle & engraved Stock & Barrel. Shoots standard roll caps. PISTOL & 20 PACKS ROLL CAPS (Express F.O.B.) \$2.50. EXTRA CAPS (ONE PACK 250 SHOTS) EACH .05.

C. C. GROFF WHOLESALE—write for catalogue 116 Broad St. Lancaster, Pa.

PRINT YOUR OWN PICTURES IN BROAD DAYLIGHT

IT'S Easy with DEVOLITE

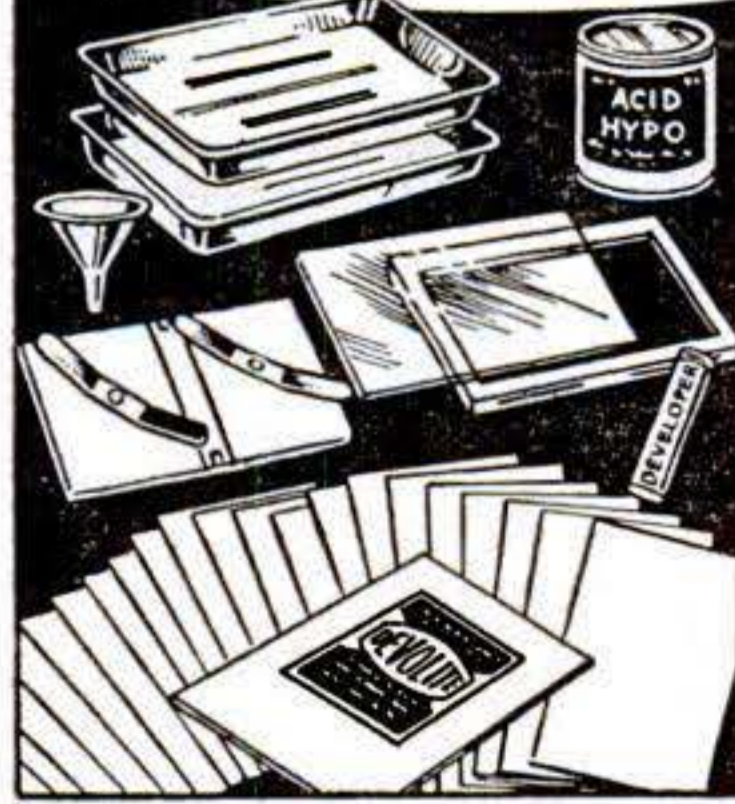

at less than 1¢ each

- No Dark Room
- No Costly Equipment
- No Technical Skill
- Clear, Sharp, Richly Toned Pictures

Make as many prints (pictures) as you want ANYWHERE—ANYTIME. Have extra prints to give to friends. Don't be "in the dark" about picture printing. Get the easy-to-use Devolite Kit, and print photos out in the open. Quick—simple—economical—thrilling! No fuss, no bother.

Makes a perfect Xmas Gift.

SEND NO MONEY—Test on Free Trial!

Prove to your satisfaction the beautiful prints you can make. Complete 7 Piece Kit includes 2 Aluminum Trays, Print Frame (3 parts), 1 Quart Acid Hypo, M.Q. Developer, Mixing Funnel, and 24 Sheets Devolite Paper. Easy-to-follow Instructions. Pay postman C.O.D. only \$2.98 and postage. Satisfaction guaranteed or money back!

UNIVERSAL PORTRAIT STUDIOS, 534 Stratford Pl., Dept. 150, Chicago 13, Ill.

Say You Saw
It In Popular Science



AUTO

BOOKS ON APPROVAL



SEND NO MONEY. Just mail the coupon for a complete set of 4 Big, Thick Auto Books. 20th Edition. Over 2700 Pages! Whether you are a mechanic or helper, expert or apprentice, auto owner or driver, take immediate advantage of this **FREE EXAMINATION OFFER.**

MAKE GOOD MONEY NOW HOLD A PERMANENT JOB

America wants its automobiles kept in good repair. Men with "know how" are in demand, at big pay. These books will help you get and hold an important job, or give you a chance to go into business for yourself now or later. Any man who half tries to improve himself can learn auto servicing and repairing by this quick reference method. Use the **JIFFY INDEX** to find easily understood answer to any auto problem. These wonder books prepared by eleven of America's great automobile engineers. Many hundreds of valuable illustrations. Send the coupon **TODAY.**

[A year's consulting privileges with our engineers now given with these books without extra charge.]
Vocational Publishers Since 1898

CAN YOU FIX IT?

These wonder books tell step by step **HOW** to make difficult repairs and adjustments, how to keep a car at maximum efficiency, including latest improvements in car design and operation. Engine troubles and how to correct them well covered.

4 BIG, THICK VOLUMES

Over 2700 pages, 2000 illustrations, wiring diagrams, etc., including Diesel engines. Beautiful modernistic, washable cloth binding.

AMERICAN TECHNICAL SOCIETY, Dept. A920
Drexel Ave. at 58th St., Chicago 37, Ill.

I would like to examine your 4 Volume Set of Auto Books. I will pay the delivery charges only, but if I choose I may return them express collect. If after 10 days' use I prefer to keep them, I will send you \$2 and pay the balance at the rate of only \$3 a month until \$24.80 has been paid. Include consulting service as offered above.

Name.....

Address.....

City..... State.....

Please attach letter stating age, occupation, employer's name and address, and name and address of at least one business man as reference. Men in service, also please give home address.

LOOK!



Navy ALL WOOL Flannel Lined TROUSERS



Made of Heavy Mountain Cloth
WAR SURPLUS BRAND NEW

Cost the Government
\$12.20 a Pair

NOW! Only

\$3.98

pair

- Farmers — Truckers
- Dock Hands — Cargo
- Handlers — Winter
- Fishermen — Duck
- Hunters — Sportsmen

Imagine a pair of ALL WOOL, flannel lined TROUSERS that were designed to keep our NAVY men warm in zero temperature at sea. These trousers not only keep men warm but also keep out DAMPNES and are water repellent. Each pair with adjustable suspenders and 4 patch pockets for convenience. Sizes: Small, medium and large. **HOW TO ORDER—SEND NO MONEY!** Just send name, address, size and quantity wanted and on delivery pay postman

\$3.98 plus C.O.D. charges or send \$3.98 plus 20c for postage with order. Illinois residents add 2% ret. occ. tax. Order today while 10,000 pair last!

S & B SURPLUS SALES CO.
2905 W. Madison St.

PS-10
Chicago 12, Ill.

MAKE UP TO \$5⁰⁰ AN HOUR In Your Own YEAR 'ROUND Business!

ONLY A FEW DOLLARS PUTS YOU IN BUSINESS!

Many Clearing as High as \$20 to \$30 a Day **NET** Renewing Rugs, Carpets, Upholstery. New Method Now Used for Auto Upholstery. Write for Facts About Quick, Easy Way to Get Started

Here is the chance you've been looking for to step into a pleasant, dignified, big-pay business of your own that offers you a steady, year 'round income. Start on "a shoestring," full or spare time, right from your own home. Equal opportunities for men and women, young or old, in small towns or big cities. No experience needed. Many making big money with new Americlean System just cleaning auto upholstery. Easy to learn. We send you complete instructions and quick-cleaning supplies so you can start making money the very first day! Quick method cleans upholstery, rugs and carpets like new without taking off floor! Tremendous demand in homes, apartments, hotels, stores, office and public buildings. Steady repeat business. Territories going fast. Write today for full **FREE** facts. No cost or obligation. Rush letter or postcard now to
AMERICLEAN CO., Inc.
Dept. H-12, 211 North 7 St., St. Louis 1, Mo.

WRITE FOR FREE DETAILS NOW!



\$2.95

TORNADO GAS TORCH

The Modern Way of Soldering

Ideal for hard and soft soldering. Will heat quickly; solder will flow freely and smoothly. No compressed air required. Self-adjusting. Safe. Economical. Can be used for annealing small parts and bending metal parts. Generates a heat of 1700° F. Simply connect to any illuminating gas jet with a rubber hose and operate. Tornado Torch No. 119 comes

with three tips, (1/8", 1/4", 3/8" blast).

Tornado Gas Torch No. 119—Complete with 2 tips, for Natural Gas or Bottled Gas; with 3 tips for Manufactured Gas. \$2.95 per set. See your dealer or order direct. Send check or money order—post paid.

Robco Corporation, 204 E. 44th Street, New York 17, N. Y.

DIVING EQUIPMENT

New & Used Surplus Equipment for Deep and Shallow Water Use. **BARGE PROPULSION UNITS**, 115 h.p. Diesel and 141 h.p. M-8 Gas.

M & E MARINE SUPPLY CO.,

P. O. Box #601-G, Camden, N. J.



INSTALL AND SERVICE OWN OIL BURNER!

SAVE UP TO \$150! Send for the famous DELTA PHOTO-INSTALLATION MANUAL. Simple, easy step-by-step photos of a complete oil burner installation. Complete with all necessary plans, drawings and easy-to-follow directions. Published under exclusive copyright at \$5.00. **SPECIAL OFFER—CLIP \$1 to this ad and mail today!**

"... am very much pleased with same. . . . I am sure it is the most complete manual ever put out by any company. . . ." B.R. Whitehall, N.Y.
DELTA HEATING CORPORATION
85-03 Northern Blvd., Jackson Heights, New York City

HOW TO BE YOUR OWN BOSS!

Send today for amazing book, "How To Start Your Own Business"! Explains in *complete detail*:—how much money you need to start . . . how to advertise, add new business . . . fees to charge, pitfalls to avoid. Covers 60 fields including: radio, advertising, publishing, credit agency, travel bureau, retailing, camera exchange! Send no money now! Pay postman \$1.98 when book arrives—or \$2.48 for handsome DeLuxe edition. If not delighted after 7 days' *free trial* return book for full refund. Write:

FOREMOST BOOKS, Dept. 127, 104 E. 26 St., New York 10, N. Y.

ON-THE-JOB METHODS

ON-THE-JOB EQUIPMENT...

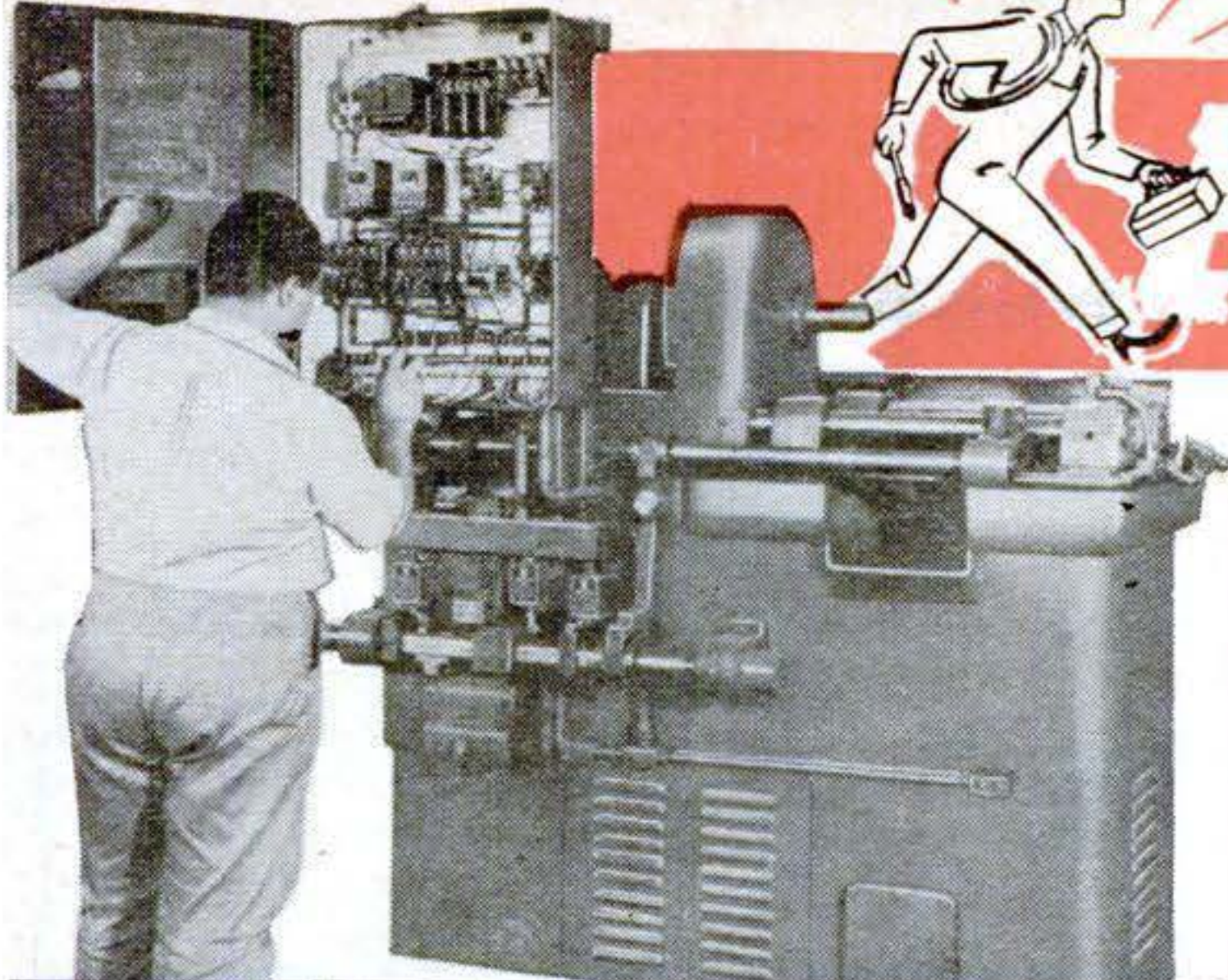

ABOVE: WIRING IN FACING MACHINE



ELECTRICITY

LEARN THE PRACTICAL WAY

on equipment like this in the large shops of the nation's largest exclusive electrical school!

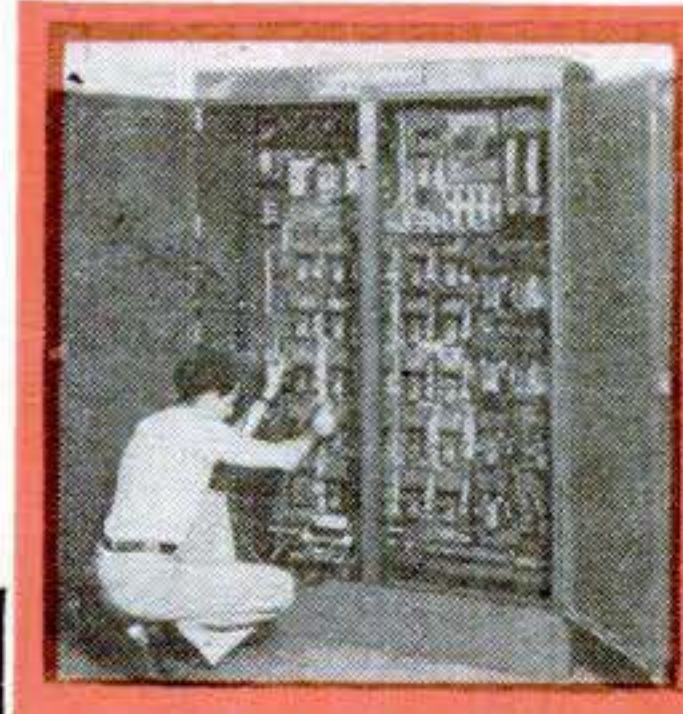

RIGHT: TROUBLE SHOOTING ON LARGE CONTROL PANEL



Electricians are always in demand—make big money... Get "A to Z" experience quickly in our large shops—not "home-study"... **YOU DO ACTUAL WORK** on real equipment. Learn housewiring, armature wiring, motor rebuilding, factory installation, etc. New classes start every few weeks. Living arrangements made.

NO COST TO VETERANS Train at Gov't expense Receive \$65 to \$90 month while learning Coupon brings details.

MICHIGAN TECHNICAL INSTITUTE
Department PS.12, 2281 West Fort Street, Detroit 16, Michigan

MICHIGAN TECHNICAL INSTITUTE, Dept. PS-12
2281 W. Fort St., Detroit 16, Michigan

- Send me catalog and complete information.
- I am a GI. Send special information.
- Married. Single.

NAME _____

ADDRESS _____

CITY _____ ZONE _____ STATE _____

STENCIL-SETS.

BRAND NEW

ALL LETTERS A to Z
NUMERALS 0 to 9
A bargain sensation! Complete stenciling outfit—with interchangeable letters, numerals and punctuation. Complete with stencil brush and stencil paste—all in a fine, natural finish wooden box—all brand new.

HAS HUNDREDS OF USES

In factories, stores, home work shops, farms—there are hundreds of uses for a stencil outfit. Put your name, address, identifying numbers, etc. on all your personal belongings—boats, ladders, shipping cases, etc. These sets are brand new. Only because they're surplus can you buy them at so low a price. Send your order today! Post paid in U.S.A.

GROBAN SUPPLY CO., Dept. PS12
1522 S. Michigan Ave. CHICAGO 5, ILL.

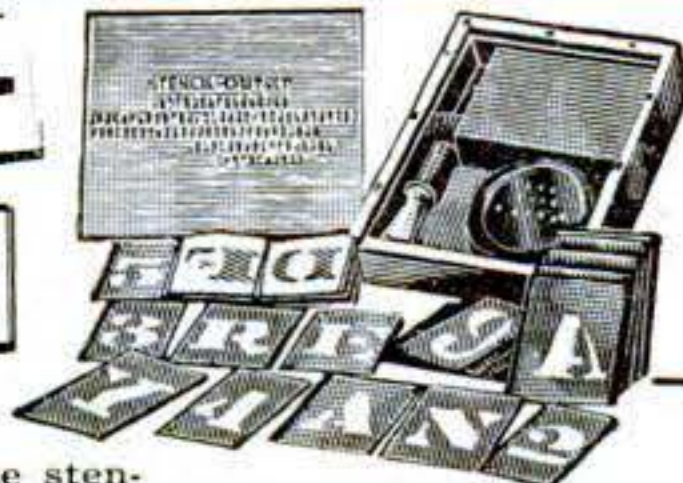

SET IN 1 IN. SIZE COMPLETE, ONLY

\$250

SET IN 2 IN. SIZE COMPLETE, ONLY

\$395

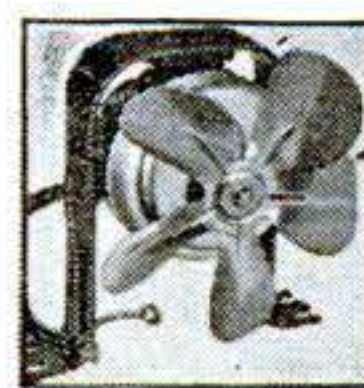

DELCO MOTORS

Fractional 1/75 H.P. Delco factory tested and guaranteed long life motor. Triple rubber mountings. Noiseless operation. 2-wire rubber cord. 110V. A.C., 60 Cy. Airflow 1000 C.F.M. For cooling and ventilating purposes in Offices, Shops, Homes, also for Refrigeration Units. Blade size 7 1/2". Stand 6 1/4" high, 4" wide. Complete as shown. Shipping weight 4 lbs.

No. 7014 Suction Type
No. 9272 Blower Type.....EACH, **\$525**

Lots of 10..EACH, \$4.90 Plus postage Lots of 50..EACH, \$4.75 Plus postage

FREE CATALOG—Send for new G. & E. APPLIANCE & PARTS CATALOG.

G. & E. Equipment Supply Co.
Dept. P.S. 9, Ogden Ave. at Fulton, Chicago 7, Illinois

CELESTIAL NAVIGATOR'S SEXTANTS (for boating, sailing, flying)



24. Type A10 (Fairchild), with bubble averaging, wood case, 2 power galian scope. Good used condition, only

\$1250



25. Type A10-A (Fairchild), with famous AUTOMATIC averaging device; original cost nearly double the A10; with wood case, 2 power galian scope. Used

\$1750



26. Type A12 (Link), fine fabric covered carrying case, extra bubble. Good used condition.....

\$1750

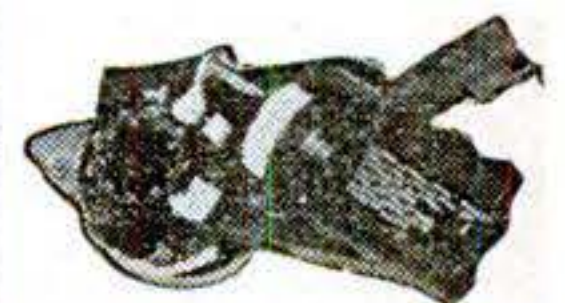

27. Type A8-A (Bausch & Lomb). One of the finest Sextants built (B&L). You get also the fine wood carrying case, battery holder, etc. Good used condition..

\$3250

(All sextants are AAF War Surplus and are furnished with flash light battery holder, attachment for night shots, and free complete easy instructions for use!)

28. SEXTANT ASSORTMENT (4), 1-A10, 1-A10-A, 1-A12, 1-A8-A; all four for only.....**\$59.50**

AERO PARTS SUPPLY

Municipal Airport, Dept. 10

Houston 17, Texas

WAR SURPLUS AND HUNDREDS OF OTHER BARGAINS



ARMY AIR CORP TYPE SUN GLASSES

Brand new! Use them for driving, sun glare, snow and all outdoor wear. Frames are 24 karat gold plated with Pyralin sweat bar—adjustable nose pads. Large aviation type lenses. Attractive leatherette case included. Buy one for yourself—one for a gift. Shp. wgt. 1 lb. Stock No. R 238, Per pair. **\$2.95**



Brand New
For Utmost
Warmth and
Comfort

TYPE B-15A FLYING JACKET

Built for warmth. Made of heavy duty zelan treated cloth with quilted fly under front zipper. Two large slash pockets. Heavy knitted waist band and cuffs. Mouton fur collar. Two roomy inside pockets. Use it for all outdoor activities—hunting, driving, working, etc. It's a real bargain at this low price. Shp. wgt. 5 lbs. Stock No. 373, Each. **\$14.95**

WATCH COMPASS

Brand new gov't surplus! Army-Navy made with single jewel mounted needle. Watch type case with snap lid. Made by Waltham and Longines-Wittnauer. Silver colored dial. Use for hiking, driving, etc. A guaranteed value! Shp. wgt. 1 lb. A splendid gift for your boy scout friends. Stock No. A 147, Each

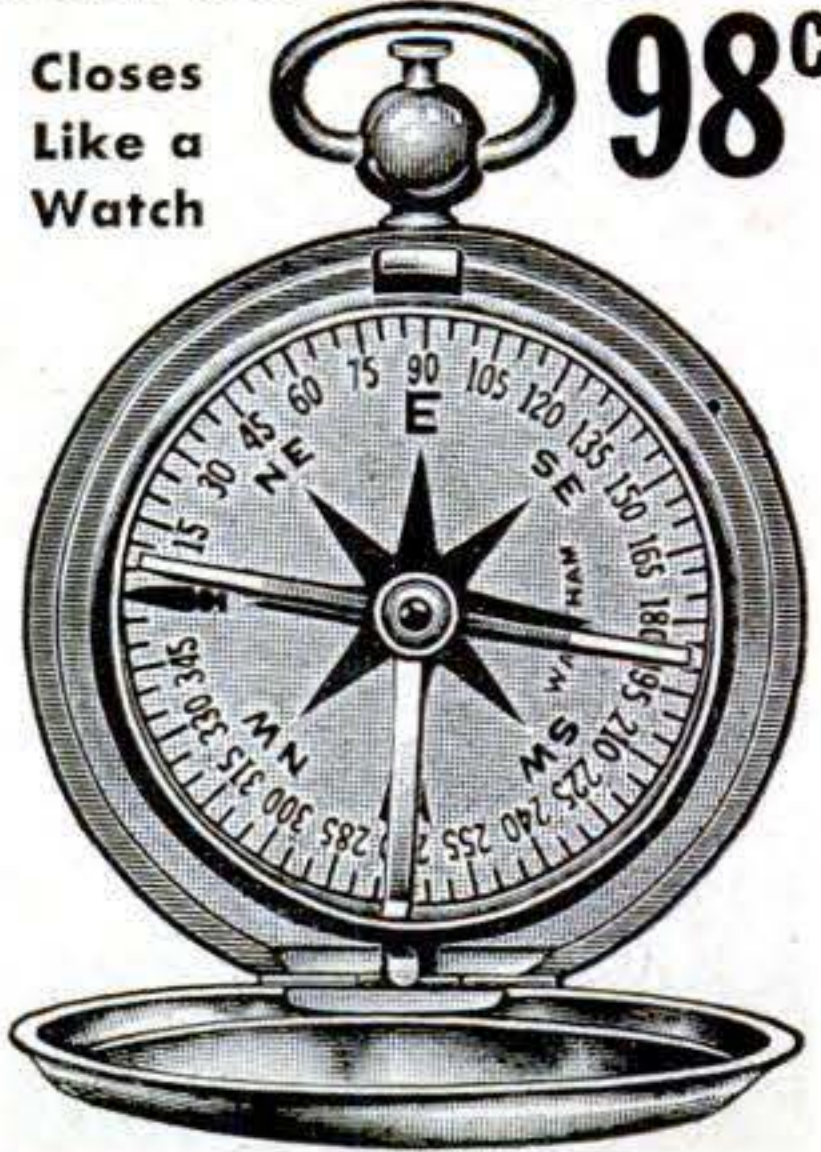

Closes
Like a
Watch

98^c



ARMY AIR FORCE TYPE A-2 HORSE HIDE JACKET

Brand new, Army Air Force type A-2 jacket of genuine horsehide. Full length zipper front. Two large size pockets with flaps. Heavy knitted waist and cuffs. Leather shoulder straps. Will keep you warm and toasty in the coldest weather. Will give you years of service. Shp. wgt. 5 lbs. Give chest size when ordering. Stock No. R 268, Ea... **\$22.50**

AMMUNITION BOX

Used for 50mm ammunition. Heavy, all metal design with latching top and folding handle. Provides safe, fireproof storage for valuables, etc. Measures 12x6x7 1/2 inches. Used but in new condition. Shp. Wgt. 8 lbs. No. 338—Each... **79c**

POPULAR RECORD ASSORTMENTS

Assortment of 50 popular dance, race, blues and hillbilly records—no two alike. Famous name bands and artists included. Used in juke boxes but guaranteed perfect. Shipped exp. collect only. No exchanges or refunds. Wgt. 28 lbs. Stock No. 303 — 50 records... **\$9.64**

No. A300—Special assortment of 25 dance records. No two alike. All popular numbers. Wgt. 14 lbs. Stock No. A300—25 records... \$4.88	No. A301—Special assortment of 25 records, mixed hillbilly, race and blues selections. No two alike. Wgt. 14 lbs. Stock No. A301—25 records... \$4.88	No. A302—Special assortment of 25 hillbilly records. No two alike. All popular numbers. Splendid value! Wgt. 14 lbs. Stock No. A302—25 records... \$4.88
---	--	---

RUBBER OVERBOARD SUIT

Here is a buy! All rubber suit with parka. Fits over your regular clothes and shoes. Can be cut apart for waist high waders, hip high or knee high boots, also armlength rubbergloves. Heavy gum rubber over fabric. Fine for those who work in the water, commercial fishermen, sewer diggers, etc. Use it as is or cut it up for waders. All brand new! Wgt. 14 lbs. No. 183, Ea... **\$4.95**

BERNARD WIRE PLIERS

Parallel acting jaws. Wire cutter at top. Brand new. Wgt. 2 lbs. No. 168, Ea... **\$1.29**

USE THIS HANDY ORDER COUPON

STARK'S, Dept. PS 12 Date.....
509 S. State St., Chicago 5, Ill.
Gentlemen: Enclosed find \$.....for items checked:

() No. R 238—SUN GLASSES	@ \$ 2.95
() No. A 147—WATCH COMPASS	@ .98
() No. 373—B-15A FLYING JACKET	@ 14.95
() No. R 268—Type A2 JACKET	@ 22.50
() No. 338—AMMUNITION BOX	@ .79
() No. 168—BERNARD PLIERS	@ 1.29
() No. A 303—50 RECORD ASS'T.	@ 9.64
() No. A 300—25 RECORD ASS'T.	@ 4.88
() No. A 301—25 RECORD ASS'T.	@ 4.88
() No. A 302—25 RECORD ASS'T.	@ 4.88
() No. 183—RUBBER SUIT	@ 4.95
() No. 664 R—BAYONET BLADE	@ .49

NAME.....
ADDRESS.....
CITY..... STATE.....

FORGED STEEL BAYONET BLADE

Of fine forged steel. Ground to shape but not polished. Ideal for making into a spear, a hunting knife or a throwing knife. Blade measures 6 3/4 x 7/8 inches, 11 3/4 inches long overall. Will take and hold a fine edge. Shp. wgt. 1 lb. Stock No. 664 R—Each... **49c**

Use coupon when ordering. Mail orders promptly filled. Satisfaction guaranteed. Send cash with order or 25% deposit, balance C.O.D. No C.O.D.'s under \$5.00, please. Include postage to cover. Ask for your copy of the big Stark catalog. It's FREE. A post card will bring it.

STARK'S

509 S. STATE ST.
CHICAGO 5, ILL.

POPULAR SCIENCE Classified Opportunities



Save time - Save Money

Classified Ads only 70c per word per insertion, payable in advance. Minimum ad 10 words. To be included in February issue copy should be in our office by December 29th. February issue on sale February 1st.

POPULAR SCIENCE MONTHLY—351 FOURTH AVE.—NEW YORK CITY 10

12 AUTOMOBILES

AUTOMOBILE Racing Book. Fifth Edition—Revised. Tells how to build dirt tracks bodies, frames, engines. Records, superchargers, rules, formulas, plans, stock conversions, roadster racing, fast Fords. \$1.00 postpaid; \$1.15 C.O.D. Ray Kuns, Department 274, Madisonville, Cincinnati, Ohio.

CLYMERTONE Twin Muffler Sets. beautiful sound, complete with necessary welded pipes, E-Z installation. Ford V-8. \$20.00. Chevrolet set with split manifolds. \$37.50. Specify car model. Clymer, Dept. B-114, 2125 W. Pico, Los Angeles 6, Calif.

AUTOMOBILE Racing Sixth Edition. 100 illustrations. Working drawings with building instructions for Ford-60 midget, California roadster, Offenhauser racer. Details on racer parts. Sample entrance blank. World's record 158.5 M.P.H. rear engine four-wheel drive car. Interesting information for fans, drivers, mechanics. \$2.00 postpaid; \$2.25 C.O.D. Ray Kuns, Department 62, Cincinnati 27, Ohio.

AUTO racing magazine subscriptions. Pacific Speedway News, \$6.00 yearly. National Speed Sport, \$4.00. Illustrated Speedway News, \$4.00. All give complete data midget, big car race results. Sample copy each 50c. Specify publication wanted. Clymer, Dept. B-112, 2125 W. Pico, Los Angeles 6, Calif.

HOLLYWOOD Hot-Rods. Photos. Instructions for fast Fords etc. \$1.50 p.p. Racing parts list, Cams, Manifold, Heads, etc. \$.25 p.p. Hollywood Hot-Rod, Los Feliz, Box 9626S, Hollywood 27, Calif.

AUTO Repair Manuals, by Victor Page. Complete non-technical data all mechanical features, operation, repair. Ford V-8 cars, trucks, 823 pages, 369 illustrations. \$3.50 postpaid. Chevrolet Six and truck, 896 pages, 363 illustrations. \$3.50 postpaid. Clymer, Dept. FC-2, 2125 W. Pico, Los Angeles 6, Calif.

IMAGINE 250 miles per gallon your car now. Literature 25c. Jet Engine Co., St. Augustine, Fla.

HIGH Compression Heads, V-8. More speed, acceleration, power. Offenhauser or Edlebrock \$75.00 complete set. Dual manifolds complete with throttle kit, fuel lines. Edlebrock \$49.00. Offenhauser \$55.00. Give make, model V-8. Catalog 10c. Clymer Motors, Dept. B-113, 2125 W. Pico, Los Angeles 6, Calif.

"VAPO-STEAMATIC" Water Injection. Easily assemble yourself (parts anywhere, only \$1.00). Latest "Controlled Humidity" system (developed by former Airforce Engineer!) "Cuts" fuel consumption! Greatly increases Horsepower. Speed! Eliminates detonation, carbon, oil pumping. Cooler, sm-o-o-ther motor! Copyrighted "Water Injection Handbook", fully illustrated—including "Installation Instructions" \$1.00. Newhouse Industries, 5941-PS Hereford, Los Angeles 22, Calif.

BRITISH Sports Cars. New Book. 96 makes described. Fine illustrations, specifications. \$3.00 postpaid. Clymer, Dept. B-117, 2125 W. Pico, Los Angeles 6, Calif.

RACING Car Equipment for all cars. Engines, Racing Heads, Manifolds, Carburetors, Mufflers, etc. Speed instructions and literature \$1.00—refunded first order. Lee Motorcraft Co., 1412-B Great Northern Bldg., Chicago 4, Ill.

PHOTOGRAPHS. World's Finest Automobiles. List 10c. Box 1028, Minneapolis, Minnesota.

KAISER-FRAZER. Floyd Clymer's new book (no connection with Kaiser) gives uncensored, impartial report 3000-mile test including Pikes Peak, Kansas City-Denver record runs, economy test. Part by part equipment analysis. Good, bad comments, no punches pulled. \$1.50 postpaid. Clymer, Dept. B-111, 2125 W. Pico, Los Angeles 6, Calif.

CUSTOMIZE Your automobile! Revised, enlarged book, latest restyling, complete, sharp, 50 photographs! \$1 pp. Post Publications, Box 723-SC, Arcadia, California.

USED-CAR Buyer's Handbook. Save dollars, grief. Photographs, dealers' tricks, complete tests. \$1 pp. Post Publications, Box 723-TC, Arcadia, California.

CUSTOM-Car Photograph Album. Fascinating automobile style classics! Coachcraft, Summers, independents, photo-packed! \$1 pp. Post Publications, Box 723-AC, Arcadia, California.

SEE our ad under Motorcycles for midget car bargains. Midget Motors Directory, Athens, Ohio.

CLYMER-LITE Aluminum pistons for Chevrolet. More speed, power, acceleration. Less vibration, heat. Complete with pin rings. \$5.00 each. Semi or finished. State size. Clymer, Dept. B-116, 2125 W. Pico, Los Angeles 6, Calif.

1947 INDIANAPOLIS Race History. Enlarged, 56 pages, 125 photographs, charts, complete details cars, drivers, specifications. \$1.00 postpaid. 320-page Indianapolis history book 1909 to now \$3.50. De Luxe Edition \$5.00 postpaid. Clymer, Dept. B-110, 2125 W. Pico, Los Angeles 6, Calif.

DUALTONE Chrystalline packed, California mufflers, single or twin for all automobiles. Carburetor Velocity Stacks. Compression cylinder heads. Dual manifolds. Large double or single chromed tailpipe extensions. Chromed Station Wagon Stacks. Fender Skirts. Request Catalogue. Dualtone Mufflers, 2636B India Street, San Diego 1, Calif.

WATER Injection for your car. More power, greater fuel economy. \$14.65 Complete. Free booklet sent on request. Spee-Dee Products, 2409 South Tenth St., Tacoma 6, Wash.

HOTROD and fast car equipment. Heads, camshafts, dual manifolds, mufflers, etc. List 25c. Build up your V8 or Chevrolet for racing, hotrod, or hot stock-car. Specify which make. Instructions \$1.00. Alden Motors, Oakland City, Ind.

NO. 4 CLYMER Historical Scrapbook. Entirely new, different. 224 pages, advertisements. Photographs 250 early automobiles, motorcycles. \$1.50. DeLuxe Edition \$2.50 postpaid. Clymer, Dept. B-118, 2125 W. Pico, Los Angeles 6, Calif.

"1948 CUSTOM Styling" Manual. Easily make car look Hollywoodized. Custom-built, Ultra-Beautiful! New simplified customizing, restyling, streamlining methods. Instructions, photographs. Plans for accessories, refinishing, mufflers, model changes—for old and new cars \$2. Almquist Engineering, Box 660-J, Brooklyn 1.

FORD Dual Muffler Kit \$20.00. Southern California Muffler Service, 11142 Washington Place, Culver City, Calif.

BUILD automatic clutch, scooters, midget autos, tractors, shop machines. Catalog Free. Nichols Equipment Co., Dept. 512, Purvis, Miss.

"BUILD speedy Midget Track Racer from castoff parts! Plans, specifications, construction information. \$1.00. Motor Supply, Box CS-1682, Toledo, Ohio."

SPEED & Mileage Manual— Obtain greater speed, mileage, racing performance from any automobile! Includes simplified methods, speed tuning, gas saving secrets. Instructions on building economizers, speed equipment, duals, mufflers, superchargers, racing fuels, fast conversions. "Hot-Rods", Part Lists. \$1.98. Almquist Engineering, Box 660-J, Brooklyn 1.

SPEED Age. The Auto Racing Magazine. Ideal Christmas Gift. \$3.00 Year. Box 237-S, Hyattsville, Maryland. Also on newsstands.

MAKE your Ford fast! Complete details, photographs. How to construct 120 mph Hotrod. \$1 postpaid. California Bill, Box L-2, Eaglerock, Los Angeles 41, Calif.

INSTALL V-8 engine in your Model A for extreme acceleration, more top speed, smoother performance. Complete details, photographs. \$1 Postpaid. A-V-8, Box L-2, Eaglerock, Los Angeles 41, Calif.

MAKE Your Model "A" do 100 mph. Lightning acceleration, breath-taking top speed. Complete details. Photographs. \$1 Postpaid. Four Barrel, Box L-2, Eaglerock, Los Angeles 41, Calif.

REX Mays Racer \$3.00. Kun's Auto Racing Book 6th Edition just out \$2.00 postpaid. Clymer, Dept. B-119, 2125 W. Pico, Los Angeles 6, Calif.

13 AUTO SUPPLIES & EQUIPMENT

WELDING bodies, repairing fenders, pays good profits using Hobart's AC Arc Welder. Catalog Free. Write Hobart Welders, Box P-1272, Troy, Ohio.

PLATING Outfits For Autoparts. Connect to a battery. No tanks used. Outfits furnished. Free particulars. Gunmetal Co., Ave. K, Decatur, Ill.

AUTO parts for all autos and trucks. Trans, motors, differentials, fenders, carburetors. Also Body Parts. Security Auto and Truck Parts, 1923-BP Grace, Chicago 13.

WELDERS for all requirements. Free Catalog. Write Hobartweld, Box P-1173, Troy, Ohio.

CHROME Air Horns—for all makes of Automobiles. Send for free literature. Protecturod Company, 4033A Windsor #2, Youngstown 7, Ohio.

ATOMIC Condenser for all Cars. Quick starting. More power: Smoother motor: Better mileage: Order yours now: \$3.00 prepaid: State make and year of car. Advanced Automotive Products, 563-0 Lake Road, Webster, N. Y.

GUARANTEED Winter Starting Ignition On Two Volts. Eliminate burned points. Unit \$16. Plans for making your own \$2. Give car make, model. Ignition Engineering Co., 3344-B Beard Ave., Robbinsdale, Minn.

AUTO Parts. We have them. New or rebuilt. Prompt shipment. Write requirements. Save money, buy direct. Factory Warehouse, Mechanics Auto Parts, 3807-PS N. Ashland Ave., Chicago 13.

NEW 1947 Crosley Engines—\$199.00 Exchange Largest stock of Crosley parts in the U. S. Witkin-Borshell Co., Inc., 217 S. La Brea Ave., Los Angeles 36, Calif.

NEED Auto Accessories, parts, hardware, ammunition, home supplies? Cutrate catalog available. Main Supply, Fairfield, Ill.

EXTRA winter starting ignition for less than \$2.00. Send \$1.00 for plans to C. Young, Box 93, Villa Park, Ill.

AUTO parts—new or rebuilt—for all cars. Starters, generators, carburetors, clutch assemblies, transmission and differential gears. Everything you need. We have large stock—can ship fast. Write us—Grove Auto Supply, Dept. PS, 4854 Cottage Grove, Chicago, Ill.

"GRIPON" Tire Chain Loader. Puts both chains on at the same time without a jack. Inside hooks fastened in five seconds with the patented fasteners without getting under. Send for circular. Agents Wanted, \$1.50 per set. C. Stark, Bartonville, Vermont.

CALIFORNIA Mufflers—Speed equipment—doll-up accessories. Save freight cost from California. Von Esser's, 2840 North Kedzie Ave., Chicago 18, Ill.

UNIQUE—6 inch auto bells. Two loud tones, no wiring. Jim Strong, 16 Concord St., West Hartford 7, Conn.

AUTOMOBILE Glass! Rubber Floor Mats! Shock Absorbers! Direct factory prices! Immediate Shipment or Quotation. Cooper's 3137 Lawrence Chicago 25.

ALL aluminum gas tanks. 2 qt. capacity, \$.65 each, 5 qt. capacity, \$1.10 each, to fit Clinton Engines. Ten Twenty Tool & Mfg. Co., 1060 Barker Road, Whitmore Lake, Mich.

OIL Pumping Motors—Details. Mullner Co., Box 3102, St. Paul 1, Minn.

14 AUTO TRAILERS

BUILD your own Trailer! Save Money! Have every feature you want! Plans for House, Sport, Camp and Utility trailers. Catalog describing 9 models 10c. (15c in Canada and overseas). Jim Dandy, Box 125-B, Wausau, Wisconsin.

TRAILERCOACHES—learn about all types—sports, living or travel. Approximately 100 pages monthly—magazine tells all. Special rate \$1 the year in U.S., \$1.50 to Canada, \$2 Foreign. Trail-R-News, Box 431-C, Glendale, California.

91 MOTORCYCLES, BICYCLES, SUPPLIES

WHEELS! Build wagons, scooters, mowers, trailers, wheelbarrows, grocery carts, baby carts, play pens, baby carriages. 4" to 16". Free list. Trulsen Mfg. Co., 811 E. 31, Kansas City, Mo.

LARGE stock Indian parts. Expert motor rebuilding. New and rebuilt Chief Motorcycle, motors only. Indian Motorcycle Sales, Kansas City 1, Mo.

WHEELS, Tires, Tubes for Motor Scooters, Midget Cars, Wheelbarrows, and Industrial equipment. All sizes. Bicycle Parts, accessories. Largest stock in United States. Send dime for list. Cycle Transport Company, 1241 S. Michigan Ave., Dept. C, Chicago 5, Illinois.

FREE! Illustrated folder custom motorcycle accessories. New seat covers, bright colors, molded cushions, \$6.75. Leather jackets, \$36.95. Chrome muffler-loudspeaker, \$15. Pacific Cycles, Dept. B1, 1208 Pine, Seattle, Wash.

"BUILD America's lowest priced motor-scooter speedster! Complete plans, specifications, \$1.00. Big list bargain priced used motors, etc., included free! Motor Supply, Box 1682-CS, Toledo, Ohio."

MIDGET racer less motor \$25; Midget car complete \$58; Factory built motor-scooters \$50 up complete; others \$25 up; German Sachs motorcycle \$50; 74 Harley \$25; Henderson motor \$5; others as low as \$3; plenty of brand new two horsepower gasoline engines in original crates; plenty new midget highway racers; plenty brand new motor-scooters; over 5,400 small tires \$1 up. (Mail Order Only). Send 25c for Big War-Bargain Catalogue Number 22, just out, listing the above and hundreds of other bargains in motor-scooters, midget cars, motorcycles, engines, parts, plans, etc. (35c by first class mail). Midget Motors Directory, Athens, Ohio.

MOTOR SCOOTERS, bicycle engines. 120 miles gallon. Dime for catalog. Clymer, Dept. B-115, 2125 W. Pico, Los Angeles 6, Calif.

T. T. RACING. New, exciting, accurate book of world famous English road racing history. Just printed, \$3.00 postpaid. See our advertisements under autos. Clymer, Dept. TT-2, 2125 W. Pico, Los Angeles 6, Calif.

"PROFESSIONAL Midget Racer, Motor-scooter, Midget Roadster, and Midget Motorcycle. Plans, specifications for all four contained in illustrated handbook, 25c. Big list bargain priced used motors, motor-scooters, Servicycles, etc., included free! Midwest, 3839 Drummond, Toledo, Ohio."

"CUSHMAN motor-scooter \$15. Shaw bicycle motor \$15. Harley-Davidson Motorcycle \$35! Send 25c for bargain catalog #8, packed with money saving buys in motor-scooters, motorbikes, midget cars, motors, wheels, tires and parts. Gail and Company, 538 Erie, Toledo, Ohio."

WHEELS. Steel Disc rubber-tired for toys, wagons, scooters, etc. Sizes 5", 6", 7", 8", 10" available. United Wheels Mfg. Co., 11727 La Fayette Ave., Chicago 28, Ill.

"CUSHMAN Motor-scooter \$20 (includes motor and extra tires), Midget Racer \$15! Send 25c for big Summer catalog #938, just printed, listing these and scores of other sensational bargains in motors, wheels, motor-scooters, motorbikes, Servicycles, tires, etc. Associated, Box CS-1764, Toledo, Ohio."

15 AVIATION

GIANT Glider Kites. Double, 14x10 ft. Lifts 100 lbs., tows car, etc. Cost Government \$108. Yours for \$20. Satisfaction guaranteed. Great Northern Mart, North Adams, Mass.

PLASTIC Bird Kite, 6 ft. Red or Blue. Fly any weather. \$2.00. Multiple Socket Fixture Co., 374 East 152, Cleveland 10, Ohio.

PROPELLERS—2 & 3 Blade, for ice-snow sleds, boats. Literature. Standard Aircraft, Box 387, Ft. Worth, Texas.

VETERANS: Flight training under the G.I. Bill. Private, Commercial and Flight Instructor Ratings. Write for information, Gottschalk School of Aeronautics, Adrian, Michigan.

PROPELLERS for Ice-snow sleds, air boats, catalog 10c. Banks Propellers, R.F.D. 12, Ft. Worth, Texas.

49 ELECTRICAL SUPPLIES & EQUIPMENT

ELECTRIC Pencil: Writes, Engraves all Metals. \$1.00 postpaid. Beyer Mfg., 229-C Dixson Blvd., Uniontown, Penna.

FREE Catalog of welders, welding supplies, generators, fencers, electric lawn mowers, freezers, and other electrical items. LeJay Company, Minneapolis, Minn.

CHRISTMAS tree light sets and bulbs. Jeannette Electric, 159 West 23rd St., New York 11, N. Y.

LAMPS—All parts to build or repair. Catalog 10c. Gyro Lamps, 5416B Clark, Chicago 40.

SELSYN Motors, 3 1/2"x5 1/2", high accuracy, 115 volt, 60 cycles, \$11.75 per pair, \$2.00 Deposit, Balance C.O.D. Weber, 150 Maple, Hershey, Penna.

RECTIFIER—0-20 amp. 0-120 V.-D.C. \$3.00. Postpaid. BP Products, 1428 Wolcott, Flint, Michigan.

ELECTRIC Motors—New, 110 Volt A.C. 1/4 H.P. Immediate shipment, \$18.75. Fair Motor Sales, 223 South Main Street, Lima, Ohio.

140 WELDING, SOLDERING

NEW Portable Champion Special transformer welder; 110/220 volts, AC. 8 heat Stages. Welds, brazes, solders, cuts all metals. Complete with electrode holder, mask, rods, carbons, fluxes, cables. Also special Flame Weld Torch, Easy to Use. Full Directions. Splendid for shop, farm and home repairs. Only \$27.50. Money back guarantee. Also resistor model, now \$14.95. Magic Welder Mfg. Co., 239 PS Canal St., New York, N. Y.

WELDERS for all requirements. Free Catalog. Write Hobartweld, Box P-1275, Troy, Ohio.

PORTABLE Arc Welder, "Build Your Own." Your engine plus Hobart Welding Generator saves \$350. Starts paying business. Free Instruction book. Write Hobart Welders, Box P-1274, Troy, Ohio.

A.C. WELDERS, 110v welds 1/2" steel \$29. Paul Morris, 1850B State St., Schenectady 4, New York.

6 AIR CONDITIONING & HEATING

HEATING and airconditioning equipment. Write Moore Equipment Company, Lincoln 6, Nebraska.

FURNACES, conversions, gas oil, L.P. Easily sold. Write for literature. Thuman Equipment, 1225 Fifth Avenue, St. Joseph, Mo.

80 MACHINERY, TOOLS, SUPPLIES

DRILL GRINDER—Grinds drills to factory accuracy. Calipers with direct reading scales. Circle cutters. New Tool grinder. Lowest prices. Free literature. Factory, 811-A East 31st, Kansas City 3, Mo.

WE offer 60 tons of new war surplus bolts, nuts, washers, screws, etc. All popular sizes. A good mixture for hobby shops, garages, machine shops & farms. A big 40 lb. box for only \$6.85. War Surplus Co., Morris & John Sts., New Brunswick, N. J.

ARC welders, AC or DC, 150-600 Ampere. Portable, stationary. Prompt Delivery. Reasonable terms. Also Electrodes and Accessories. Free Catalogs. Write Hobart Welders, Box P-1276, Troy, Ohio.

CASTINGS. Blueprints. Materials for woodworking and metalworking machine tools. Suitable for commercial or home shop production. 23 items. Catalog 10c. Lewis Machine Tool Co., 3217 Union Pacific Avenue, Dept. S, Los Angeles 23, Calif.

GEARS For inventors, experimenters, model makers, schools, work shops, laboratories, etc. Government surplus made of brass, bronze, dural steel and stainless steel. 12 matched pairs; 24 gears, bevel, spur and ratchet. List price \$12.00 our price \$2.50. 25 matched pairs; 50 gears, includes larger gears, also sets of worm gears. List price \$30.00, our price \$5.00. Limited Quantity. Order now. Write for our bulletins on ball bearing, rectifiers, Relays, Selsyns, Horns and government surplus materials, Met Exchange, 323 Canal Street, New York.

CONCRETE Block machines \$39.50 up. Catalog free. Concrete Mold Company, 5466 Gravois, St. Louis, Missouri.

METALS: Aluminum, brass and steel in all shapes. Write for free catalog, F & H, 87 Warren St., New York 7, N. Y.

ASSORTMENT—Aircraft small parts. Clamps, Fasteners, Terminals, Rivets, Nuts and Bolts. All New, 3 lbs. Postpaid anywhere in U.S. Only \$1.00, cash with order. Satisfaction Guaranteed. Limited Supply. Conner Sales Co., 917 South Main, Fort Worth, Texas.

MACHINE Tools for metal and wood. We specialize in small equipment. Tell us your needs and we will quote you. Kandler, Kalamazoo 12, Michigan, Dept. P.S.

V BLOCKS at low prices, 10 sizes for all purposes. Free Literature. Miles Products, 2532 Wabash, Chicago 16.

12" BAND saw, tilting table, Oilite bearings, \$35.00. 6" jointer, ball bearing, 43" long, \$59.50. Spindle shaper, ball bearing, 15x20 table, interchangeable spindles, \$49.50. 8" bench saw, large tilting table, ball bearing, complete, \$29.50. Immediate delivery. Dealers wanted. Write for catalog. Backus Machine Co., Boyd, Wisc.

TOOLS, supplies for machine shops, home craftsmen, hobbyists. Low prices. Catalogue 10c. Refund on order. Precision Tool Service, 55 E. Washington, Chicago 2, Ill.

REVERSIBLE Induction Motor or Selsyn, 1/20 hp, 110 volt A.C. size 3 1/2x5 weight 5 lbs, 5/16 shaft, ball-bearing, precision made for rugged service. Simple conversion, motor or selsyn. Instructions included. Value \$22.50, price \$5.50. Radioco, 1110-M Marshall Bldg., Cleveland, Ohio.

V-BLOCKS, adjustable, 4"x4"x15"; 1 1/2"x 1 1/2"x4"; both \$2.95; Threefold, \$6.75, Tenfold \$16.75. Am-Standard, 1208 North 13th, Philadelphia 22.

EQUIP your Drill Press with a Utility Tray for holding tools and parts, \$4.95. Circular Free. Lorenzen Industries, Niles, Michigan.

NEW War Surplus, 1/2 h.p. Motor, 27 V D C. . . . \$4.95 G.E. Selsyn Transformer . . . \$1.25 Dynamotor, G.E., Input 27 V, Output V 115 D.C. . . . \$4.95 Pressure Tanks, 500 Cu. in. . . \$2.50 G.E. Oxygen Pressure Gauges, Dial calibrated 0 to 500 lbs. . \$1.50 Toggle Switches . . . 25c FOB K.C. . . . Send check or money-order . . . No COD's General Salvage, Dept. PS-12, 2920 E. 27th St., Kansas City, Mo.

COMPRESSORS, 100-1500 lbs./sq. in. \$32.50 New Portable. Details Free. Hilker Products, 614 Jefferson Ave, Brooklyn 21.

CODE Machines. Catalog 5c. Omnigraph, 810 E. 39. Brooklyn 10, N. Y.

DRILL GRINDER for twist drills \$2.95. See ad on page 274.

MACHINE shop tools released for private industry; Gridley Auto Screw Machine \$300. 17" x 7' Engine lathe \$160. 16" x 6' Quick Change engine lathe \$580. #3 Brown & Sharpe Miller \$730. #2 Kemsmitz \$540. Snyder 25" Drill \$140. Barnes 24"; tapping attachment \$225. 5 H. P. single phase motor \$100. 36" band saw \$225. Van Norman "Rilio" grinder \$140. Buda 4 cyl. motor \$90. Money back guarantee. Conversion Parts Co., 277 Adams St., Boston 22, Mass.

LONG'S Index Head for the Lathe. Milling Machine, Drill Press, etc. Write for folders. Satisfaction guaranteed. Box 537, Torrington, Wyoming.

17 BATTERIES, GENERATORS, ETC.

EDISON Alkaline Storage Batteries for home lighting, motors, radios, etc. Complete, interesting literature free. J. Hawley Smith Co., Croton Falls, N. Y.

19 BOATS, OUTBOARD MOTORS, ETC.

FULL size, cut to shape boat patterns, blueprints, 7½-38 feet. Illustrated "Build a Boat" catalog, 10c (coin). "How to Build Boats" book, \$1.00. Cleveland Boat Blueprint Co., Dept. A-77, Cleveland, Ohio.

MARINE Power—Easily convert any Ford and Jeep motor (domestic and foreign) with Osco parts and kits. Complete catalogue 25c (coin). Osco Motors Corp., 2020C E. Orleans St., Phila. 34, Pa.

"PLYWOOD Rowboat and Motor Boat K.D. Kits. Assemble and save up to \$57.50. Three popular models. Resin bonded, water-proof plywood construction. Easy to assemble in spare time. Write for free literature and complete specifications. C. R. Dillaugh Boat Co., 7928 N. E. Mallory, Portland 11, Oregon."

NEW, used, rebuilt marine motors. Marine conversions, fittings. Free Catalog. Stokes Marine Supply, Dept. 23, Coldwater, Mich.

"\$35 SEA Shell pre-fabricated 8' plywood rowboat. Free illustrated catalog. Hagerty, Cohasset, Massachusetts."

P-38 BELLY Tanks, New steel 10 ft. 2 in. 165 gallon \$9.95. Mr. Buckman, 89-V, Merced, Calif.

COMPLETE Kayak Kit. Nothing additional needed. Excellent present for son, brother, dad. Literature, Play-Acks, Dedham, Mass.

MOLDED and sheet plywood boat kits, ready to assemble, 8 to 14 ft. \$40.00 up. Genuine Weldwood marine type plywood in various thicknesses and lengths. Send 25c for literature. Marine Mart, Buffalo 7, N. Y.

MARINE Catalogue—15,000 deliverable items pictured that should be pictured at price. Send \$1.00. Marine Mart, Buffalo 7, N. Y.

"MARINE conversions for Ford and Jeep engines. Catalog 10c. Lehman Manufacturing Company, Department A, Newark 2, New Jersey."

"OUTBOARD motors—good values, used motors. Also used parts for most makes and models. Crandall-Hicks Co., 912 Commonwealth, Boston, Mass."

51 ENGINES, MOTORS, ETC.

WELDERS for all requirements. Free Catalog. Write Hobartweld, Box P-1278 Troy, Ohio.

ELECTRIC Motors ⅛ Horsepower 110 Volt AC—DC High speed (Reconditioned) Limited quantity \$6.50 B. Price 1394 Fulton Ave. Bronx 56 N.Y.

WINDING Data, listing 225 motors, single and three phase, \$1.00. Motor Data, Box 7631, Kansas City 3, Mo.

"BUILD Your Own" Portable Arc Welder. Your engine plus Hobart Welding Generator saves \$350. Starts Paying business. Free instruction book. Write Hobart Welders, Box P-1277, Troy, Ohio.

DIESEL & Gasoline Engines, New, Used Parts and Batteries. Helwege Marine Service, 108 Floral Blvd., Floral Park, N. Y.

MOTOR Winding Tester, for A.C. motors. Repair men send for bulletin. Motor Industries, Quincy, Illinois.

WELDING Generator, 150 ampere, \$47.50. Other bargains. Butler, 1885 Milwaukee, Chicago.

7 AMERICAN POLICE JIU JITSU

DEADLY Judo—Fiercest fighting technique, Trick knockouts. (200 photographs—plus illustrations.) Expert instructions—Three volumes. Complete \$2.25. Variety House, Box 46-AY, Wall Station, N.Y.C. 5.

20 BODY-BUILDING COURSES

MUSCLES (Free Pictured List). Barbells, Cables, Equipment. Nat Berent, 1090 W. 43rd, Norfolk 8, Va.

HANDBALANCING—Acrobatics, easily learned. Write, Power, 923 W. Vine, Kalamazoo, Michigan.

BARBELLS! Free Course and Catalog! 95 pound set \$9.80; extra plates 9c pound. Bur Barbell Co., Lyndhurst, N. J.

BAR-BELLS, Dumbbells, Exercise equipment, Courses, Free booklet. Good Barbell Co., Reading, Penna.

124 SPORTING GOODS, GUNS, FISHING TACKLE, ARCHERY

"AMMUNITION"—"New and Used"—"Shotguns"—"Rifles"—"Revolvers"—"Pistols"—"Fishing Tackle"—List 10c. Rudolph's, Atchison, Kansas.

SKI-TOWS. Portable. Auto-powered. 500 ft. long. Pulls you both ways. Up, level or downhill. Set up in 20 minutes. Only \$125. Send card for particulars. Great-Northern Mart, North Adams, Mass.

1½ H P Neptune Outboard—Brand New \$52.00—10% deposit required. Outboard Sales, 3419 Nashville Avenue, New Orleans, Louisiana.

5000 BARGAINS, firearms, binoculars, war relics, catalog 40c. Smith Museum, Runnemede, N. J.

SEND 10c for list 100 new and used guns. Frayseths, Wilmar, Minnesota.

SHOTGUNS, Rifles, Revolvers. Over 500 Modern Obsolete. Also Cartridges. List .10 coin. Ed Howe, 26 Main Street, Coopers Mills, Maine.

GOLFER'S Gift—ideal for Christmas. Golfer will enjoy personalized golf balls with his or her name stamped permanently on balls. All balls are top-quality and newly-manufactured by nationally known manufacturers—no seconds! Prices as follows: Wilson K-28 Black (for low handicap players) or K-28 Red (durable distance ball) 95c each. Wilson Flag-Hi 70c each. John Robert 95 (95c value) 69c each. John Robert 70 (70c value) 49c each. Print clearly name to be stamped on balls (maximum 13 letters). We pay postage; gift card enclosed on request. Minimum order three balls. No C.O.D.'s please. Send check or money order to John Robert Sales Co., Box 1, Dept. K-1, Clayton 5, Missouri. Order with confidence direct from ad or write for detailed circular.

55 FIELD GLASSES, TELESCOPES, ETC.

TELESCOPES, Binoculars, Microscopes. —big bargain catalog free. Brownscope Company, 24 West 45th Street, New York.

SAVE Money, build your own reflecting telescope from complete kit of finished optical parts: 3" diameter, 39" focal length, mirror and diagonal both hard aluminized, plus 3 lenses for high power eyepieces. All \$6.00. Ross, B68 West Broadway, New York 7, N. Y.

PORRO prisms for 6x30 Binocular. Perfect. 50c each postpaid. Ross, B-68 West Broadway, New York, N. Y.

NEED Christmas money? Binoculars bought any condition. Rochelle Optical Co. New Rochelle N.Y. Binoculars repaired.

REFLECTING Telescope, complete 3½" diameter, equatorially mounted. View planets, stars, \$19.75. Write Skyscope Co., 475-5th Ave., New York.

TELESCOPES, Microscopes, Cameras, Binoculars, Barometers, Books; Buy, sell, repair. Lists 10c. Rasmussen-Reece, Amsterdam, N. Y.

POWERFUL Astronomical telescope easily made. Perfect lenses and instructions. 100 power \$2.50. 100 and 200 power \$3.50. 100, 200 and 400 power \$5.50. Clear vision and full power guaranteed. Instructions alone 10c. Suffolk Science Service, Manorville, N. Y.

7x50mm PRISM Binoculars, Zeiss design. New, save to 75%. Sacrificed \$49.50 plus tax. DuMaurier Co., 21 State, Elmira, N. Y.

43 DOGS, BIRDS, PETS, RABBITS

\$250 MONTHLY. Raising Angora Rabbits. Particulars free. White's Rabbitry, Newark, Ohio.

FOR Sale—Coon Hounds. Combination Tree Hounds and High Class Fox Hounds. Rabbit Hounds a specialty. Dures Thomas, Route 3, Albertville, Ala.

ST. BERNARD Pups: Champion sired beauties. Franklin Young, R. 3, Riverhead, Long Island, New York.

CHRISTMAS give Birds, Canaries, Finch, 100 kinds monkeys. Russell's Aviaries, West, Texas.

RAISE Guinea Pigs. Make money at home. Big demand. Booklet free. Taylor, Box 426B, Hapeville, Georgia.

RAISE guaranteed Chinchilla rabbits. Greatest profits from gorgeous furs, delicious meat, valuable breeders. Experience unnecessary. Fascinating hobby. Year-round money-making business. Write world's largest breeder today. Willow Farm, R45, Sellersville, Penna.

YOU Can make real money raising Golden Hamsters, the new amazing tiny animal. Food costs less than 10c month per animal. Breeds in 16 days! Easily raised in basement, attic, garage, barn or shed. Write for convincing details. Hudson Hamstery, Box 78-S, Palisades Park, N. J.

RAISE Diamond Seal Rabbits. We pay \$30 to \$60 each. Continuous market prices guaranteed. Booklet on raising rabbits 25c, with hutch plans \$1. Hansen's Rabbit Institute, 1347 Miller Avenue, Salt Lake City 6, Utah.

GREAT Danes: Apollo of Dogdom for Protection and companionship. \$100.00 upward. Shipped on approval, time payments. Kalmardanes, Stone Mountain, Ga.

SEE "Golden Hamsters" ad on page 44. Shows hamster picture.

GOLDEN Hamsters excellent Christmas pets. Easily shipped. \$5.00 pair including two metal cages. Information free. Hatha-way, 609 Deerfield, Silver Spring, Maryland.

COCKER Spaniel puppies, shipped express. Bruce Kennels, Lyons, New York.

83 MILK GOATS

RAISE Dairy Goats. "All about goats and goat milk in big, illustrated monthly magazine. Sample copy 25c. Special Introductory year subscription only \$1 (regular \$2 a year). Booklet, "Primer for Goatkeepers", Free on request. Dairy Goat Journal, Dept. 868, Columbia, Mo."

52 FARMS OTHER REAL ESTATE

OZARK Lands for All purposes. Actual river frontages. 5 acres \$90.00 and upwards. Free list and literature. Hubbard, 424H, Minnesota Ave., Kansas City 4, Kans.

GOOD Farms—Ranches, Washington, Minnesota, Montana, Idaho, Oregon, North Dakota. Dependable crops, favorable climate. Write for literature, lists describing typical postwar farm opportunities. Specify which state. J. W. Haw, 120 Northern Pacific Ry., St. Paul 1, Minn.

FARMS, Ranches. All kinds, sizes. Choice of location, climate, production. Information on irrigation projects Columbia and Missouri River Basins. Resorts, summer homes. Milwaukee Railroad territory: Washington, Idaho, Montana, Dakotas, Wisconsin, Upper Michigan, Central Corn Belt. Free folders, price lists. L. H. Robbins, 613 Union Station, Chicago 6, Illinois.

STROUT'S Big Farm Catalog—Mailed Free. Describes over 2800 outstanding Bargains. Coast to Coast. Time-Money Saver. Write Today. Strout Realty, 255-ZB 4th Avenue, New York 10, N. Y., 20 W. 9th St., Kansas City 6, Mo., 453 S. Spring, Los Angeles 13, Calif.

WARREN County, Virginia Cattle, Shenandoah River, 218 Acre Farm. Modern Residence, Bank barn, fenced. \$27,500.00. Claude L. Rust, Box 284, Front Royal, Va.

CANADA—for literature and information re general farming, ranching and fruit lands, write H. R. Williams, Department of Immigration & Colonization, Canadian Pacific Railway, Vancouver, B. C.

HOMESITES \$450—convenient payments. California's finest garden section. On Morro Bay's scenic shores. Wonderful fishing, hunting, boating, bathing. Fertile soil, softest water, temperate climate, congenial community. Free literature. Richard Otto, 6560-Z, Hollywood Blvd., Hollywood 28, California.

FLORIDA—Hunting, Fishing, Fruit Growing, 5 acres, \$245.00, \$10.00 down, \$10.00 a month. G. B. Potterfield, Route 1, Brooksville, Florida.

108 POULTRY AND SUPPLIES

RAISE turkeys the new way, write for free information explaining how to make up to \$3000.00 in your own backyard. address National Turkey Institute, Dept. 57, Columbus, Kansas.

PRACTICAL Money-Making poultry raising helps from Experimental Farm only \$1.00 for 24 Months! Sixty Months, \$2.00. Subscribe today! Poultry Tribune, Dept. T, Mount Morris, Ill.

RAISE Fryers new easy way; one-man home plant earns \$500 monthly. Booklet Free. Poultry Guild, 1046-B S. Olive, Los Angeles 15, Calif.

111 PROFITABLE OCCUPATIONS

DETECTIVES Earn Big Money. Excellent opportunity. Detective Particulars free. Write, Wagoner, P-125 West 86th, N. Y.

ANNOUNCING home study course in commercial baking. Practical basic training. Good field for those with aptitude. Nearly depression proof. Send for Free booklet, "Opportunities in the Baking Industry." National Baking School, 1315 Michigan Ave., Dept. 1729, Chicago 5, Ill.

\$40.00 WEEKLY. Made growing mushrooms. Fresh. Dried. Dominion Patent 331.583. free spawn. North American, 169Y Yonge, Toronto, Canada.

SHELLCRAFT—Beginners kit \$1.00. Catalog free. Burton, Box 27, Station A, St. Petersburg, Florida.

\$5000. from half acre growing Ginseng. seed supplied. Crop bought. Particulars 10c. Associated Growers, 1109 Corydon Ave., Winnipeg, Canada.

UNPAINTED Plaster Ornaments made from new, wonderful Loxite. Beautiful designs easily decorated with water colors or oil paints. For Profit or hobby. Illustrated List Free. Midwest Novelty Mfg. Co., 108-B Cedar St., Anaconda, Montana.

PANNING Gold—Learn how. Illustrated booklet-catalogue of mining books and supplies. Free. Old Prospector, B-69, Dutch Flat, Calif.

HOME Manufacturing business. Manufacture novelty Ladies' lapel pins. materials penny dozen. Sensational profits. no experience. no expensive equipment needed. Few dollars starts you. Plastex Products, 1025 Prague St., San Francisco 12, Calif.

WANT to work your way around the world? And make Fifty Dollars weekly? Postcard brings particulars. Modern Mariner, Box 313x, Palestine, Texas.

MAKE beautiful costume jewelry at home for large profits, hobby or therapy. Free illustrated wholesale catalogue of sea shell, metal and plastic parts contains detailed instructions. Florida Supply House, Bradenton, Florida.

\$150 PROFIT in 4 days made by Floyd Brown, Iowa. You, too, make Big Money in your own profitable business with amazing Liquid Imitation Marble, Fibre-Tite Flooring and Flexible Molds. Full or spare time. Experience unnecessary. Work from your own home. Write for Free Catalog, full information today! Composition Products Co., Dept. 123, 5853 Delmar, St. Louis, Mo.

MUSHROOMS Grown. Boxes, Barrels; Illustrated Instructions, 50c. Spawn \$1.00. Gordons, 553 William, Winnipeg, Manitoba.

MAKE beautiful mirrors from ordinary window glass. No expensive equipment required. Details free. Tes-co, Box 189-SE, Wilkes Barre, Penna.

INCREASE your earnings—Learn Neon Glass Blowing—Free Information. Public Educational Service, 493 Irving, Bridgeton, N. J.

BRONZE Molds for metal novelty casting. Fritz foundry, 622 N. Fulton, Allentown, Pa.

22 BOOKS, PERIODICALS, ETC.

WHAT Every Mason wants. We have Masonic books for Blue Lodge, Chapter, Commandery Scottish Rite and Shrine. Our rituals are used the world over. Send for our free catalog of books and rituals for Masons, Odd Fellows, Knights of Columbus, etc. Ezra A. Cook, Publisher, Inc., P.O. Box 796-RMY, Chicago 90, Ill.

MAGAZINES (back dated)—foreign, domestic, arts, books, booklets, subscriptions, pin-ups, etc. Catalog 10c. (refunded). Cicerone's, 863 First Ave., New York 17, New York.

EDUCATIONAL Books sold cheaply or rented for small fee. Books bought. Money-back guarantee. 4,000 Bargains. Catalog Free. (Courses Bought.) Lee Mountain, Pisgah, Alabama.

750 POCKET books. Retail, wholesale. Catalog Free. Gordon's, 2613-B Crenshaw, Los Angeles 16.

BOOKFINDERS! Out-of-print, unusual books quickly supplied. Send wants. (Books bought). Clifton, Box 1377ps, Beverly Hills, Calif.

FREE bargain catalogue for adult book buyers. Kassin, Box 134, Madison Sq. Sta., New York City.

BRILLIANTLY—Colored Outdoor Pictures also adult books. Sell out list free. Lefferts, Box 48, Brooklyn 25, N. Y.

ARTISTS Pin-ups. 15 photos \$1. List—Sample 10c. Baker Service, Box 1840, Cleveland 6, Ohio.

"FIX It Yourself"—home repair book. How to fix appliances, furniture, plumbing, etc. 256 pages, 163 pictures, \$1.49. Popular Science, Dept. 127-C, 353 4th Avenue, New York 10, N. Y.

"RADIO For The Millions"—practical book. Complete instructions for building 78 radios, phonographs, other sets. 192 pages, 648 pictures. Regular Edition \$1.49. Popular Science, Dept. 127-C, 353 4th Avenue, New York 10, N. Y.

FACTS About Nudism. 50c. Sensational. Roys, Box 531, Waterbury, Conn.

BACK issues magazines, reasonable. Reedmor, 240 East 9th, N. Y., N. Y.

MAGAZINES—Trade and Class. Current copies. All fields. Free pricelist. Commercial Engraving Publishing Co., 34S North Ritter, Indianapolis 19, Ind.

MEN Only. Fresh stuff in little Books. 10 for \$1.00. DuLaw Novelties, Box #297, East Chicago, Indiana.

COLLECTORS Photographs — Curios — Books—Lists dime. Jack's Shop, 591 12th Street, Oakland 7, Calif.

HORSE Racing Books, systems. Free Illustrated Catalogue, Charles Hall, Sepulveda, Calif.

BORROW "Best Sellers" and All Late Books. No need to Buy Them. We loan them to you by mail—postage prepaid. A New Reading Plan for book lovers at amazingly small cost. Write for details. Postal Book Exchange, Suite 900-901-902 Lakeview Building, 116-P South Michigan Ave., Chicago 3, Ill.

1948 CATALOG. Wholesale Directory 10c. Latshaw Sales, Sunnyside-C, Indianapolis, Indiana.

NEW books. Reductions. Free valuable catalogue. Continental Publications, Elmhurst, N. Y.

BOOKS. Art. Architecture. Home Building. Decorating. Catalog 10 cents. Artcraft, 6827, Baltimore 4.

ADULT Books. Revealing Sex Truths—Illustrated, 50c. Kogan, 1032-SB, New York 8.

BACK-Date Magazines, Books, Specific issues—years. Arkell's, Tarzana, Calif.

81 MAGIC TRICKS, PUZZLES, ETC.

MAGICIANS', Gamblers' secrets exposed. Cards, Dice, Punchboards, Slot Machine. Catalog 10c. Book Co., Box 671, St. Louis 1, Mo.

"MAGIC Vanishing Card". Throw it into air, it completely disappears, reproduce it later from spectators pocket. Easy to do. Complete 25c with magic catalog. The Magician, 2463-D, Kensington Ave., Philadelphia, 25, Pa.

WORLD'S largest professional magic shop, keeps you in touch with latest tricks. To receive mailings, send 35c for new catalog. Holden's, 220-P West 42nd St., N. Y.

200 ELECTRIC Stunts, 110 volts, \$1. Cutting Sons, Campbell 3, Calif.

500 TRICKS. Send only 10c for Douglas' famous 112-page Catalog 500 Tricks. New magic for amateur, professional. America's fastest service for 25 years. Douglas Magicland, Dept. 2, Dallas, Texas.

BIG Magic Magazine, trick and price list—25c. Lloyd S. Jones, 4064—39th Avenue, Oakland 2, Calif.

PERFORM over 100 baffling sleight-of-hand tricks with ordinary thimble. Easy! 42 action photos, complete instructions \$1.00. Garnet Specialties, Box 502-B, Valparaiso, Ind.

500 PAGE catalog. 6,000 novelties, gadgets, timesavers, hobbies, fun-makers, etc. 10c. Johnson Smith, A-74, Detroit 7.

FREE! Large Catalog of magical apparatus if you remit 25c for "Magic Is Fun" magazine. Robbins Co., 152-F West 42nd Street, New York.

FAMOUS Slip Block Puzzle—Postpaid \$1.00. Ketko, Box 2 P, Cincinnati 24.

THE True Secret of Ventriloquism. Free booklet. Quackenbush, Big Flats, N. Y.

"MYSTIFY your friends. New Illustrated. Narrated, Card Tricks, copyrighted. \$1.00. Box 691B, Atlantic City, N. J."

"MAGIC For Fun or Profit", 10c. Inexpensive pocket tricks. Magic Cellar, 230 Bankers' Investment Building, San Francisco 2, Calif.

WOW 'Em with DeLand's spectacular "Card Locator"! Locate any card in ordinary deck! Deal straight royal flush! 25c catalog of magic, rare courses and books, included. Ar-Ges Company, 790 Broad St., M103, Newark 2, N. J.

SQUIRTING Ring—Bloody Soap Powder—Hot Gum. Terrifically Funny! All \$1.00. Funalogue 10c. Thor Sales, 853 46th St., Brooklyn 20, N. Y.

BE a Magician. Large professional magic catalog of latest tricks, 25c. Ireland, F-109 North Dearborn, Chicago.

MAGICIANS' Headquarters — 400-Page Professional Catalogue, pocket, parlor, stage tricks. World's finest magic. Send \$1.00 for Catalogue (refunded first \$5.00 order). Kanter's, S-1311 Walnut, Philadelphia 7, Penna.

GUARANTEED magic tricks! Amateur, Professional. Big 8½ x 11 illustrated catalogue. 10c. Newton's, 202-B1, Bonham, Tex.

HYPNOTISM! 25 Lesson Course, \$1.00. Monarch, 38-S Jefferson, Auburn, New York.

VANISHING Quarter trick and catalog 25c. Sterling Magic Co., Royal Oak, Mich.

MODERN Speed Hypnosis: Hypnotize subject within minute. Easily mastered. Course \$1.00. Hypnotism, One Vreeland Avenue, Passaic, N. J.

63 GAMES, ENTERTAINMENT

UPSET "Law of Averages". Flip any coin heads or tails at will! Copyrighted manual 35c. Arro, Box 961-S, Bridgeport 1, Conn.

HOME Model Slot Machines and Coin Operated Games. Write for catalog. Webb Distributing Co., Dept. P4, 6 South Kedzie Ave., Chicago 12, Ill.

SKYFIGHTER Electric-eye anti-aircraft and target gun. You build it low cost. We furnish electronic units. Excellent marksmanship trainer. Details 10c. Hilker Products, 614 Jefferson Ave., Brooklyn 21.

36 COIN COLLECTING

3,000 BARGAINS:—Antique Firearms, Indian Relics, Coins, Flintlocks, Rifles, Minerals, Swords, Pistols, Cartridges, Fossils. Illustrated Catalog 25c. Heike, Wenona 30, Ill.

GET Profit and Pleasure in collecting old coins. Send 10c for 56-page illustrated coin catalog. You'll be delighted with it. Send for it now. B. Max Mehl, 374 Mehl Building, Fort Worth, Texas. Largest rare coin establishment in U. S. Established 47 years.

OLD Money Wanted. Will pay \$100.00 for 1894 Dime, S. Mint., \$50.00 for 1913 Liberty Head Nickel (not Buffalo). Big Premiums paid for all rare coins. Send 4c for Large Coin Folder. May mean much profit for you. Numismatic Co., Dept. 30, Fort Worth, Texas.

WORLD Coins 30 different \$1.00. Harry Elsholz, Box 9014, Pittsburgh 24, Penna.

COMMEMORATIVE \$½ — Columbus, Washington, Cleveland, Stone Mountain, \$1.50 en. Illustrated Catalogue 25c. Norman Schultz, Salt Lake 9, Utah.

40 MIXED Indian Pennies \$1.00. 50 different foreign coins \$2.00. Internat'l, 656 West 171, N. Y. 32.

GENUINE Roman coins 2000 years old. Two for \$1.00—10 different \$4.00. Delmonte, 725 West 172, N. Y. 32.

\$2.00 TO \$200 each paid for hundreds of Old or Odd Coins. Indian-Lincoln-Foreign Wanted. Keep all until posted. Send 20 Cents for illustrated Coin Value Book, 4 x 6. Guaranteed Prices. 40 years in business. Coin Exchange (1), Le Roy, N. Y.

COINS For Collectors, reasonable prices. Free lists. Hutchinson, 3463 "I" Street, Philadelphia 34, Penna.

INTRODUCTORY offer—U.S. Rare Coin Value Guide 30c—send postal note to Hobby Helpers, Dept. B2, Box 665, Washington 4, D. C.

50,000 COINS, medals, papermoney. Illustrated lists free. Nagy's, 8 South 18th, Philadelphia 3, Pa.

NEW Dime Picture of American Destroyer on it \$1.00 or two facsimiles 25c. fool your friends Dep't PS. 7252 So. Green Chicago Illinois

96 OLD STAMPS WANTED

I WILL pay \$100.00 each for 1924 1c green Franklin stamps, rotary perforated eleven (up to \$1,000.00 each unused). Send 6c for large illustrated folders showing Amazing prices paid for old stamps, coins, and collections. Vernon Baker, P.S.-712, Elyria, Ohio.

WHAT have you to offer? Collection? "Shoebbox" accumulations? Anything in Stamps? We urgently need them. Spot cash paid. Cosmopolitan Stamp Co., 1457 B'way, N. Y. C.

127 STAMP COLLECTING

WORLD'S Largest Diamond And Triangle Stamps, Free Stamp Magazine. Stamps from Fighting Free French. 20 stamps from 20 different Countries. Pictorials, Airmails, Big Bargain 5c with approvals. Capital Stamps, Dept. 10, Little Rock, Ark.

DEALER'S Wholesale Catalog. Postage 3c. Franksco, 5031 Queensbury, Baltimore, Maryland.

300 DIFFERENT given free with approvals. Postage 3c. Windsor Stamps, 1435 E. 67th Place, Chicago 37.

ZOWIE-E-E! A Barrel of Fun for only a Dime! 500 United States Stamps—Absolutely unpicked and unsorted, just as received from church missions. Many varieties, including large commemoratives, airmails, high denominations up to \$5.00! Stampdom's biggest package of fun, and you might find something really valuable!! Price only 10c to serious approval service applicants. Money back if not delighted. Illustrated bargain lists with each order. Mystic Stamp Co., Dept. 55, Camden, New York.

START your own stamp business. Write for free circular. Donald Shepard, Box 5139, Chicago 2.

UNITED STATES approvals complete coverage fine quality, attractive prices. Seminole Stamps, Box 1138-S, Coral Gables, Florida.

FREE—United States Columbian Set—8 Values. Retailing \$3—Absolutely Free to Customers for our Unusual Approvals. Send 3c Postage for Selection Plus full particulars. S. D. Engel, 38 Park Row, New York.

25c SENT with your request entitles you to \$1 worth of stamps, your choice, from our gigantic first approval selection. Cosmopolitan Stamp Co., 1457 B'way, N. Y.

FREE! Negro Triangle; Turks Islands "Cactus"; Dakar; Guinea; Palestine; "Fairy Tale", Pirate Chart, Map, Ship, Sea Lion and Snake stamps; French, British, Portuguese Colonies, etc., Free for 3c postage. Approvals. Potomac Stampco, Washington 10, D. C.

"200 DIFFERENT stamps—cataloging up to 50c each—only 3c to approval applicants! Littleton Stamps, Littleton 47, N. H."

55 DIFFERENT United States—5c. Approvals. Utechts, 1143-D North Keeler, Chicago 51.

FREE. Fascinating Airmail Collection, including obsolete Liberian issue with approvals. 3c postage please. Raymax, 123-X William St., N.Y.C. 7.

"WOW!! \$10.00 Worth Of Fun—Only 10c! What a treasure hunt! Big package 500 Foreign Stamps from foreign missions, other sources. Includes Stamps from Africa, South America, Free French, Cape Juby, Palestine, etc. Includes airmails, commemoratives and stamps worth up to 50c. This offer sent for 10c to Approval Applicants only. Jamestown Stamp Co., Dept. 5, Jamestown, N. Y.

FINE Approvals. Fast, personal service. What countries do you prefer? I'll send their stamps. Milton Skinner, 438 Locust, Long Beach 12, Calif.

NAME your favorite countries. Stamps sent for 5c with approvals. C. H. Brooke, 427 W. Sedgwick, Philadelphia 19, Penna.

GIBRALTAR Packet Free—Nice collection Gibraltar—New Zealand Centennial—British Uganda—French Colonials—Early British Colonial—West Indies—South American—War stamps plus Philatopic Monthly Magazine. All for 5c postage. Empire Stamp Co., Dept. P R, Toronto 5, Can.

FREE—Canadian Sets Royal Visit, George VI, George V, Coronation, Jubilee, others, to approval applicants. Ensign, Box 118-P, So. Orange, N. J.

FREE! Crystal-Mount Sample. Harrisco, 204 Transit Bldg., Boston, Mass.

POSITIVELY Greatest free offer—Latest Scott's International \$6.00 stamp album—covering entire world, contains 36,000 illustrated descriptive spaces; Scott's 1948 Standard \$6.00 catalogues "Philately's Encyclopedia"—absolutely free to applicants for foreign approvals becoming customers. Bargain Stamp Service, Santa Ana, California.

128-PAGE United States Catalog, 1000 illustrations, 10c. Harris & Co., 202 Transit Bldg., Boston.

FREE—25 different to sincere applicants for specialized U.S. Foreign approvals. J. F. Nicosia, 3650 Bronx Blvd., Bronx 67, N. Y.

"\$1.00, \$2.00, \$5.00 U.S., Roosevelt, Hitler, Airmails, free with approvals. Tamiami Stamps, Box 2188, Miami 13, Fla."

DUPLICATE Stamps traded for Full Value. Free details: Stamp Ranch, 2804 Rio-grande, Austin, Texas.

NORWAY Victory Stamp Free! Foreign approvals. Miami Stamp Company, Box 2437-D, Miami 14, Fla.

FREE—The Stamp Finder. Big new edition—32 pages profusely illustrated! Tells at a glance the country to which any stamp belongs and so where to place it in your album! Also: 25 different stamps from Vatican City, Palestine, Cyprus, San Marino, etc. All sent to Approval Applicants enclosing 3c postage. Garcelon Stamp Co., Box 918, Calais, Maine.

FREE! Triangle Roosevelt, Vatican, Ethiopia, Hitler Heads, with Approvals. Florida Stamp Company, Box 807, Miami, Florida.

BRITISH, Spanish, French Colonies, Vatican, Hitler heads, and airmail packet, free with approvals. Pan-American Stampco, Box 145, New York 33, N. Y.

"UNITED STATES Invasion of Germany" complete set, also twelve different Confederate States, also scarce United States \$5.00 stamp with inverted overprint, also complete set of United States stamps surcharged for use in Canal-Zone. Entire Collection 10c. Approval applicants only. "Stamps", Box Eighty-Seven, Albany 1, N. Y.

UNITED STATES Price list. Send Postage, State Stamp Corp., 1225 Park Bldg., Pittsburgh 22, Penna.

20,000 DIFFERENT 1c-5c each! Gordon Davison, Box 1019A, Manchester, N. H.

FREE U. S. Price list postage 3c. M. Hanna, 335 5th Ave., Pittsburgh 22, Pa.

HISTORICAL Collection! Cavalry Charge! (Bulgaria)—Flaming Sword! (Ireland)—Big She-Wolf! (Italy)—Fort! (Dominican Republic)—Field Marshal! (New Zealand)—Pitcairn Mutiny Island!—Commemoratives! Pictorials! Only 3c. Approvals. Star Stamp Company, Dept. 1, Lakewood, N. Y.

WORLDWIDE Different: 200-25c; 500-60c; 1000-\$1.50; 2000-\$4.25. Beacon Sales, Maynard 3, Mass.

OLD scarce U. S. Seconds, on approval. Slightly defective, bargain prices. Hearnfeld, 551 Clinton, Newark 8, N. J.

FREE!! Mint British Colonies from Solomon Islands, Caymans, Grenada, Dominica, Turks Caicos. Absolutely free to new approval applicants. Viking, 130-P Clinton St., Brooklyn, N. Y.

MINT Nicaragua Will Rogers Set 10c to applicants requesting approvals. Michalicka, 101 Third Ave., Newark, N. J.

30 **SCANDINAVIA** 10c. to approval applicants only. Bjorn Nielsen, Monmouth 1, Maine.

10 **DIFFERENT U. S. Over 40 Years Old,** 5c Foreign, U. S. approvals. Scott, 22 Middle St., Lexington 73, Mass.

FREE 50 Danish with Approvals. Lush, 12863a Caldwell, Detroit 12, Mich.

200 **DIFFERENT** stamps of the world including stamps up to 80 years old. Free to collectors requesting approval service of US and foreign stamps. Roberts, P.O. Box 796, N. Y. 8, N. Y.

400 **FOREIGN** 47c, 200 27c Pacific, P.O. Box 5704, Los Angeles, Calif.

LARGEST United States single stamp 10c, with approvals. Marshall's, Box 5152, Denver, Colo.

UNUSUAL item of interest for your collection. Italian Bombed Monuments. Complete set of 15 elegant mint stamps, 10c Approvals. Stampex, Stanley, N. Y.

ZANZIBAR, Caymans, Siam, Roosevelt, Hitler 5c Approvals. Postzegel, Windham 1, N. Y.

DEALERS; Wholesale catalog 3c. Frank Oakes, 344 Normal Parkway, Chicago 21.

GERMANY 500 different \$3.00. Masser, 322 E. 9 St., Brooklyn, N. Y.

DIFFERENT United States 10c Price list free. Seidenberg, Cassopolis, Mich.

WHOOPIE! Wow! 25c worth of U. S. stamps free! No obligations! Write: M & N Co., 742 Sheffield Ave., Brooklyn 7, N. Y.

50—**SOUTH.** Central America—10c. Box 6618, Northeast, Kansas City, Mo.

YOUR Money's Worth! Seychelles, Djibouti, Angola, Chinese Hunger Stamps and over 100 different other stamps. Everything 10c to approval applicants. Atlas Stamps, 4220 West 16th, Dept. M, Little Rock, Ark.

PENNY Approvals that satisfy. Neil Gronberg, Box 5441S, Philadelphia 43, Pa.

ROGUES Gallery Packet, Hitler-Mussolini, 30 others. 3c. Premium, Hartland 6, Me.

"SEND for our better U.S. approvals today. Box 488-A, Minneapolis."

"**NUDE** Duchess" set (2 values) 5c with approvals. Royal Stamp Co., Tamaqua 2, Penna.

NORFOLK ISLAND first day cover 20c with requests for approvals. G. Stickeler, 20 Belvidere St., Brooklyn 6, N. Y.

TWO mint Costa Rica sets, 10c, with approvals. Vargo Stamps, 6044 South Fairfield, Chicago 29, Ill.

U.S. approvals, Swell arrangements, low prices. Panther, Box 76, Dorch, 24, Mass.

INTRODUCTORY combination: 15 U. S. and foreign covers stamped with worthwhile commemoratives, pictorials, airmails, etc., \$1.00. Sea Horse, 1311 Lincoln Place, Brooklyn 13, N. Y.

WHOLESALE list. Dealers only. Borkman, 3414 10 St., Tampa, Fla.

50 **DIFFERENT** Belgium stamps and our price list, one silver dime. Stamp sales, Box 1649F, Oakland 4, Calif.

55 **DIFFERENT** Airmails including large bicolored Pictorials 25c only to adult approval applicants. Collectors' Stamp, 130 West 42, New York 18, N. Y.

SEND 10c and we will mail you 100 valuable foreign stamps, and each month we will send you many stamps on approval. Inter-Ocean, 168A West 46th, New York 19, N. Y.

GIFT. Approvals, Imperial Stamp Company, Dept. C, 519 Crystal Ave., Findlay, Ohio.

25 **DIFFERENT** Stamps 10c. Tunis And Carpenter, Wakeman Ave., Newark 4, N. J.

PICTORIAL Packet! Philippines, Patiala, Palestine, Paraguay, Portugal, Porto Rico, Poland, Peru, Persia. Free to Approval Applicants. Eliot Stamps, 86-31 Eliot Avenue, Rego Park, N. Y.

DOLLAR Each; 2000 British; 1200 U. S.; 400 Ireland; Seiden, 1331-S Intervale, N. Y. 59.

FREE! 25 different Switzerland, with approvals. Eric Kardell, 1175-P Clay, San Francisco 8, Calif.

75 **DIFFERENT** U.S. Centenary Poster Stamps: Dramatic Designs, Pony Express to Aeroplane. \$2.50. Nicklin Co., 110 W. 42nd St., N. Y. 18, N. Y.

BEAUTIFUL France Boy Scout Jamboree Stamp free to collectors requesting approvals. Larry Hendry, York, Penna.

NEW Philippine Roosevelt free with approvals. Granada, 4891A Southwest 5th Street, Miami 34, Fla.

BRAZIL Truman, Monaco Roosevelts 4 Pictorials 10c to approval applicants. G. Hegenbarth, 1545 Ardmore Ave., Chicago 26.

5 **SETS—Five** countries—Triangle, Orchid, Maps, Animals. With approvals 5c. Arthur Wirth, Norwichtown 2, Conn.

FREE: Twenty different foreign commemorative stamps to new approval applicants. Modern Stamp Service, 644A East 233rd St., N. Y.

PHILA-PRINTS. 22 subjects \$1.00. Sample 10c. Eaton's, 618-A Eaton Rd., Rochester 12, N. Y.

ALL different, 25 Canada, 25 Denmark, 25 Finland, 25 U.S. Free with approvals. Alatalo, Maynard 1, Mass.

AIRMAILS. 25 Different 10c. Approvals. MacDonals, 30-P Seaman Ave., New York 34.

United States Stamps on approval. Bargain prices. Metropolitan, 140-A Nassau, New York City 7.

FLAG Stamp Free With U.S. Approvals. E. Wenigman, 929 Oakdale Chicago.

FREE-Fleetwood cover guide crammed full of valuable information about the grand hobby of cover collecting. Send for your free copy to-day. Fleetwood Cover Service, Pleasantville, N.Y.

SEND me 100 or more commemoratives or airmails. I will send you same quantity European commemoratives, airm. Dory de Cates, San Sursum, Davos Switzerland Europe

LOW priced United States approvals. N.E. Whitlow 302-E South Barnett, Dallas 11, Texas

50 DIFFERENT British Colonies 5c. Attractive Approvals, Elcerrito, 5611-S Meade, San Diego 5, Calif.

\$27.00 CHINA Airmail, Philippine Victory, Mexico Census Complete, All Different Packet 10c with Approvals, Mutual Stamp Service, 364 19th Ave., San Francisco, Calif.

NEW Germany Leipzig set free foreign United States Approvals accompany order, Yokum's, Box 1327, San Antonio 6, Texas.

IRAQ, ten different 5 cent. approvals. Kress, Box 144, Hanover, Pa.

70 HOBBIES, COLLECTIONS

INVENTING can be an interesting and profitable hobby. Write for complete particulars. Institute of American Inventors, Dept. 30-E, 2926-Eye St., N. W., Washington 6, D. C.

500 PAGE catalog, 6,000 novelties, gadgets, timesavers, hobbies, fun-makers, etc. 5c. Johnson Smith, A-75, Detroit 7.

KLONDIKE! For Hobby Jewelry Makers! Novelty Jewelry Findings swept from tables of large manufacturers—parts for Bracelets—Pins—Earrings, etc.—unfinished, Chains—Rings—Pins—Stones—Clips—Beads—many other items—1 Lb. Bags—\$2.00 Per Bag in 5 Bag Lots, \$3.00 Sample Bag, Prepaid Only, Mdse. Distributing Co., 19 E. 16th St., New York 3, Dept. P.S.

24 DIFFERENT pictorial comic buttons \$1.00. Theron Fox, 1024-A Carolyn Avenue, San Jose 10, Calif.

"GENUINE" deep red Arizona Rubies (Garnets). Send quarter for packet. Mineral Specimens Company, Box 2651, Phoenix, Arizona.

CAMPAIGN Ribbons—Beginner's Package—Introductory Price—50c, contains 15 Assorted Ribbons, L.H.G. Company, 19 E. 16th St., N. Y. 3.

TWENTY-FIVE Interesting Historical Postcards, \$1.00. Hill, 1208 Church, Flint, Mich.

CIRCUS Photographs! List and Sample 10c. Box 1028, Minneapolis, Minnesota.

UNUSED Match Book Covers, 100 all different \$1.00. Free catalog Charles Edelman, 1311 P East 84, Cleveland 3, Ohio.

NEW Scientific Hobby Catalogue (Biological) 10c. Quivira Specialties, Topeka 2, Kansas.

"SWAPPERS Hobby Bulletin" Whatcha Got? What'd'ye want? Trial two dimes. Royal Oak 128, Mich.

LIQUOR, Wine or Beer labels. What can you mail me? Liberal prices for genuine unusual brands, Hal Graham, "Connoisseur of Liquor Labels," Box 1311, Monterey, Calif.

8 ANTIQUES, RELICS, INDIAN GOODS

ANTIQUATE-modern pistols, revolvers, swords, daggers, armor, 174-page illustrated catalog 50c. Robert Abels, 860½ Lexington Avenue, New York 21.

85 MINERALS & PRECIOUS STONES

MINERAL specimens, rough gems. Sapphire 10c. List free. Mission Mineral Mart, 818 Fort Stockton Drive, San Diego 3, Calif.

GEMS, precious and semi-precious, all genuine from world wide sources. Deal direct, no overhead, save money. Catalog 10c. Hill Co., Route 7-K, Salem, Oregon.

"LUCKY" Lodestones, highly magnetic natural magnets. Perform many extremely interesting experiments. Two large specimens only 50c postpaid. National Scientific Company, 2204 W. North Ave., Chicago 47, Ill.

26 CAMERAS, PHOTO SUPPLIES

CASH! Spot cash for cameras, lenses, binoculars, movie and still equipment. Send full description for prompt cash offer. Over 36 years of dependability. Bass Camera Co., Dept SP, 179 W. Madison St., Chicago 2.

DEVELOPING and Printing Kit—Complete \$4.95. Kit #1: Three 4x6 Trays, One set of Printing Masks, One Safe-Light, Four Universal M-Q Developer, One Qt. Acid Fixing powder, One pkg. (24 sheets) Print Paper, One Graduate, One 4x6 All-Metal Print Frame, One Thermometer, Two Film Clips, One Instruction Booklet. Kit #2—Same as above but includes a Candid type Camera that takes 16 pictures on each roll of film—Complete \$7.95. We can supply all items needed for replacement listed in above Kits. Send money order or check today and include 75c to cover handling and postage Sorry, no C.O.D. orders. Simon Bros., 144 Elmora Avenue, Elizabeth, N. J.

BASS Says: Trade Cameras? For 36 years Finest equipment available. Always Satisfaction Guaranteed Or Your Money Back! Bass buy 'em, trades 'em. Bass Camera Co., Dept. SP, 179 W. Madison St., Chicago 2.

OIL coloring photographs can be a fascinating hobby or profitable sideline for those with artistic talent. Learn at home. Easy simplified method. Send for free booklet. National Photo Coloring School, 1315 Michigan, Dept. 1746, Chicago 5, Ill.

ARTISTS Pin-ups, 20 photos \$1. List—Sample 10c. Baker Service, Box 1840, Cleveland 6, Ohio.

CAMERAS! Amazing Discounts. State needs. "Foto", Box 185, Washington, D. C.

ENLARGER? Build your own cheap. We show you how. Complete plans \$1.00. Somerset Specialties, 10514 Somerset, Detroit 24, Mich.

CAMERA'S-Enlarger's—Movie Film—Big Free Catalog. Cavalier Camera, 1822 Center, Pittsburgh 19, Penna.

35mm FILM, 100' rolls, DuPont Superior #2, from surplus, outdated but guaranteed. Load your own cartridges for less than 10c each! \$1.25 each—3 for \$3.50. Delta Photo Supply, 690-S Third Avenue, New York 17, N. Y.

KODABROMIDE Enlarging Paper, 4¼ x 825 feet rolls, enough for almost 2,000 4 x 5 enlargements. Single weight. Actual tests prove its worth. Fully guaranteed. Reduces printing costs to a fraction of a cent apiece. Value over \$30.00—Our Price \$2.25 postpaid in USA. Delta Photo Supply, 690-S Third Avenue, New York 17, N. Y.

ARTIST'S Models: 15 for \$1. List—Sample 10c. Sparton Sales, Cleveland 8, Ohio.

102 PHOTO FINISHING

OIL coloring photographs can be a fascinating hobby or profitable sideline for those with artistic talent. Learn at home. Easy simplified method. Send for free booklet. National Photo Coloring School, 1315 Michigan, Dept. 1722, Chicago 5, Ill.

18 CHRISTMAS Cards and envelopes \$1.00. 60—\$3.00. send negative. Three prints each 8 exposure rolls 40c. Two each 35c. One each 25c. Reprints 3c. Fred A. Eastman, Bode, Iowa.

LOW Cost—Mammoth Blowups, Photo Display, 827½ Cherry Street, Chattanooga 2, Tennessee.

ROLL developed and 8 prints 30c. Overnight Service. Free Mailers. Tri-Plex Photo Service, Box 375, San Francisco, Calif.

50 VELOX reprints, \$1. Suburban Studio, 1410-S Bond, Rockford, Ill.

KODACOLOR negatives enlarged 5x7 \$2.50. Send Remittance. Gilbert Color Laboratories, 418 New York Street, Huntington 3, W. Va.

THREE 8x10" enlargements, \$1.00. Send negatives. Phototron, Desk S, Andover, Mass.

90 MOTION PICTURES, SOUND EQUIPMENT

LEARN movie projection, management. Free Catalog. Theatre School, Elmira, N.Y.

RARE 8-16mm, Silent-sound films. International, 2120 Strauss, Brooklyn, N. Y.

BEAUTIFUL Kodachrome Slide and Lists 25c. Slide Supply Service, 3111 West Tuscarawas, Canton, Ohio.

MOVIE Cameras! New Lektro Junior 16mm electric, magazine-loading, F3.5 anastigmat lens, viewfinder, battery, cord, tripod socket. Complete. Ready-To-Operate Only \$59.50. Money Back Guarantee! Free booklet. Magazine film, panchromatic for this camera—\$2.50. Free processing. Fotoshop Inc., Room 72, 18 E. 42 St., New York City.

8-16MM, Silent-sound films. Complete rental library. All latest subjects. Free catalogue, (sample film 10c). Garden Film, 317 West 50th, New York 19.

MOVIE Film At Tremendous Savings! Kodak Super X, Gov't stock, Tested—Guaranteed! 16mm 100 ft. \$2.95; 50 ft. Magazine \$2.50; Double 8mm 25 ft. \$1.65. Super XX, 50c add'l. each roll. Free processing. Fast service. Photo-Surplus Sales, Box K-6, 12 Duane St., New York City.

RENT 16mm, sound films 50c reel. Large selection; free catalog. U. C. Film Service, 128 Chestnut Street, Roselle Park, N. J.

NEW Caesarian Delivery—Latest Hospital Technique now available 400 ft. Kodachrome—B & W 8mm and 16mm. Sherwood Pictures, Dept. K, 1569 Broadway, Bklyn 7, N. Y.

HOLLYWOOD Films. Color sample, \$1.00. Catalog 10c. Stone, Lunenburg 10, Mass.

CHILD Is Born By Caesarean Delivery. Project outstanding movie production free. Send postal card. Movie Films, Hamilton 1, Ohio.

EXTRAORDINARY 1948 Film-Equipment Bargain Catalog. 5c. Towers, 935 North 40th, Philadelphia 4.

EXCLUSIVE Home Movies Select Films. Write for Free List. Home Pix, 1674 Broadway, New York 19, N. Y.

35 mm SILENT, Sound Films, Supplies. Bedner, 5300 So. Talman, Chicago.

HUNDREDS of Reels for less than 25c a reel, 8mm and 16mm. Send stamp for details. Bonnie's Film Club, 422 Haven Avenue, Hamilton, Ohio.

ART model films 16mm rentals exclusively, adults list. Enclose stamp. Revere Films, Box 1051, Detroit 31, Mich.

WE Buy, Sell, Rent, Exchange Home Movies. Details for dime. Midland, Box 429, Oak Park 3, Ill.

IMMEDIATE delivery of 16mm Sound projectors. Large stock of Castle, Official, Nu-Art and Pictorial films. Soundies Comedies, 16mm Ansco color film. Used 8mm, 16mm Sound, List Titlers, Splicers, Editors, Rewinders. (Home Movies, 41 South Fourth Street, Allentown, Penna.)

NEW Aesop's Fables Cartoons for home movie fans, 16mm and 8mm, 13 different subjects never before released. Write for free circular. Supreme Cinema Co., Dept. PS, 175 Fifth Ave., N. Y. 11, N. Y.

PROCESS your own movie film. Literature. Duro Products, 1519 N. Eggert, Eggertsville 21, N. Y.

UNUSUAL movie, "Temptation" featuring beautiful models, 100 ft. 16mm \$5, 50 ft. 8mm \$3. COD's accepted. Fine Arts, Box 2084, San Antonio 5, Texas.

JOIN World's largest cinematographic society. Details free. International Cine Society, Suite 218, 6770½ Hollywood Blvd., Hollywood 28, Calif.

MAKE big money selling our new sensational films. Send for sample movie and free wholesale price list: \$10.00 16mm sound; \$7.50 16mm silent; \$2.50 8mm. Standard Pictures Corp. Universal City, Calif. Dept. B.

FILM—Free processing 100 ft. 16mm. Weston 12 \$3.25. Weston 24 \$4.90. Weston 64 \$4.95. 25 ft. double 8mm. Weston 12 \$1.50. Weston 24 \$1.89. Weston 64 \$1.99. Free Circulars. Fromader Genera, Davenport 5, Iowa.

GUARANTEED Fresh anti-halo outdoor movie film! Weston 16! Daylight loading! Processing free! Three spools double 8mm \$4.50! 100 ft. 16mm spool \$4.50! Postpaid! Catalog. Eso-S, 828-A West 39th, Kansas City 2, Mo.

ART Films: 50' 8mm, \$2.75; 100' 16mm, \$6.00; 100' 16mm sound, \$7.50. Catalog Free. 16mm Viewer with 150 Art Figure Poses. \$2.00 postpaid. Bruno 2¼x3¼ Art Negatives, 6 for \$3.00 postpaid. Beautiful 35mm Color Art Slides, 10 for \$3.50 postpaid. Seconds, 25 for \$3.95 postpaid. Fresh Ansco 20 exposure 35mm Color Film, 3 rolls for \$4.50, plus 15c postage. Garmann's, 3808-C Eastern Avenue, Baltimore 24, Md.

BRAND new regular \$39.95 16mm 400 ft. streamlined motor driven projectors only \$29.95 postpaid. Sterling's, 679 Northampton, Easton, Penna.

PROJECTOR Owners—Large selection 8mm 16mm movie subjects. Send complete Edition plus \$1.00 exchange to "Camera Shop", St. Johns, Mich.

SPECIAL! Free Subscription Offer! Amateur Screen Photography, 3021B Narragansett, Chicago, 34.

NEW 750 W 16MM sound projectors \$275 sound wire recorders. Film exchange write Holmes, 3030 Germantown Ave., Phila. 33, Pa.

500 WATT 8MM Projector \$49.50 - 110V - Selco Products Danvers, Massachusetts.

MOVIE films 100'-16MM \$2.25, three rolls \$6.00, 25' double 8MM \$1.25, developing included, Ambassador, 479-A-Quincy St., Brooklyn 21, N. Y.

FREE movie catalog write Superior Films, Box 713, Dept. 2, Troy, N. Y.

FREE 2x2 Color Slide and Fine Grain Negative! Send self addressed stamped envelope for samples and catalog, Slidecraft, 5855-B Hollywood Blvd., Hollywood 28, Calif.

92 MUSIC, MUSICAL INSTRUMENTS

WESTERN, Popular Records—late numbers 29c, Catalog 3c, F-L Shop, Box 19S, New York 35, N. Y.

SAVE 30% to 60% when buying Drums, Trumpets, Clarinets, etc. Rayburn, 267 Huntington, Boston.

PHONOGRAPH Records Cheap, Catalogue, Paramount, SJ-313 East Market, Wilkes-Barre, Penna.

MARINE Band, Chromatics, Hohner Harmonicas, all kinds, Piano Accordions, Everything Musical, Hawes Music Store, Portland, Maine.

BOOGIE-WOOGIE Magic Piano Keyboard Slide. Anyone can boogie any song in any key. Points out the exact Basses to play, \$1.00. Nelson Enterprises, 102-1651 E. 93, Cleveland 6, Ohio.

SWISS Musical Units, \$3.25, Musical Albums, Music Boxes, 131 West 42nd, N. Y. 18.

POWERFUL tone for violins, Fraser Shoulder Rest does wonders. Ask Fraser, 2025 Stark, Saginaw, Michigan.

BRING our store to your door. Quality instruments, pianos, accordions, guitars and accessories. Send for catalog. Harden's Musical Merchandisers, Marion 1, Ohio.

122 SONG WRITERS

POEMS Wanted to be set to music. Free examination. Send poems, McNeil, Master of Music, 510-PS, S. Alexandria, Los Angeles, California.

SONGWRITERS, Songs Published Monthly, Advance Royalty. Send your songs or poems today for our exciting offer. Hollywood Tunsmiths, Dept. 10F-C, 1537 N. Vine, Hollywood 28, Calif.

POEMS Wanted For Musical Setting. Send poem for free examination. Five Star Music Masters, 646 Beacon Bldg., Boston.

"SONGWRITERS: Send Poems for Free Examination and Outstanding offer. United Music, 116, Salem, Indiana."

SONGWRITERS Investigate Outstanding Service. Song Poems, Melodies. Publishers List Free. Song Productions, Dept. L-12, 113 W. 48 St., New York 19.

SONGWRITERS. Send us your Songs and Song Poems. Hollywood Composers write melody Without Charge. Lead Sheets and Records furnished. Send song material Today for Free Examination. Write for details. Cinema Song Company, Dept. B-52, Beverly Hills, California.

SONGWRITERS—Protect your songs. Get the facts first. Free booklet, attractive offer. Song Service, 331-J West 46th, N. Y.

POEMS wanted for musical setting. Send Poem for immediate consideration. Hamann Service, 626 Manhattan Bldg., Milwaukee, Wisc.

SONGWRITERS! Honest Outstanding Music Writing Offer. Dick Reynolds, Leonard, Texas.

112 RADIOS, SUPPLIES & EQUIPMENT

MAKE Simple, Tubeless, Batteryless, Distance-Getting Crystal Radios, Crystal and illustrated instructions 25c postpaid. Allen, 427-S, Clinton, Mo.

U.S. Signal Corps Featherweight Ear-phones \$1.00. Radio Service men and experimenters send stamp for our giant radio catalogue. Save dollars. United Radio Co., (100-V) Newark 1, N. J.

RADIO & Television Catalog—Free! Money saving prices on Radios, Hard-to-get Parts, Record Changers, Wire and Disc Records, Amplifier Systems, Tubes, Books, Amateur and Test Equipment. Write today! Radionic Equipment Co., Dept. 1511, 170 Nassau Street, New York 7, N. Y.

MY all wave crystal set gets Switzerland, England, France, aircraft, amateurs. Plans \$1.00. Love, 62 Gaston, W. Orange, N. J.

YOU can align superheterodyne receivers accurately, without signal generator or other expensive instruments or your money back! Complete, simple, instructions only \$1. Chas. Gates, 302 Ross, Pecos, Texas.

BUILD "Loudest" Crystal Radio. Instructions. Loud Crystal, 25c. Amorose's, Route 4, Richmond, Virginia.

RADIOMEN, Servicemen, Beginners—Make More Money, Easily, \$250 Weekly possible. We show you. Information Free. Merit 216-32H 132nd Avenue, Springfield Gardens 13, N. Y., N. Y.

RADIO book:—"Everybody's Radio Manual." Tells how to service all radios at home. 256 pages, 216 pictures, DeLuxe edition, \$1.49. Popular Science, Dept. 127-C, 353 4th Avenue, New York 10, N. Y.

HALLICRAFTERS, National, other radios wholesale. Terms. Write. Henry Radio, Butler, Missouri.

24 PAGE plans "18 Crystal Sets" (SW record 5800 miles), including "Radio-builder." Catalog—25c. Laboratories, Eye-t, San Carlos, California.

NEW and used records Wholesale. Jude Specialties, P.O. Box 1084, Altoona, Penna.

26 YEARS Experience radio repairing at your fingertips. I've repaired 45000 radios. Have perfected simple system you can follow step by step. No calculations or formulas. Total price \$2.00 postpaid or COD. Moneyback guarantee. Ross Radio, 1461-B Grandriver, Detroit 27, Michigan.

200 SERVICE Hints and Short Cuts in Radio Repairing \$1.00 prepaid. Chapman Radio, 805 So. 20th Street, Birmingham, Alabama.

RADIO Controlled Garage Door Opener—Works from button in car. Complete plans \$1.00. Chapman Radio, 805 So. 20th Street, Birmingham, Alabama.

FM Television antennas, ham parts, Bargain List. Wholesale Supply, 347 Lunenburg St., Fitchburg, Mass.

SPEAKER Pillow—Dynamic—Connects to any radio. Simple instructions included. \$12.50 list, \$6.00 Prepaid. Chapman Radio, 805 So. 20th Street, Birmingham, Alabama.

AMERICA'S Best Buys. Radio Tubes 29c up. Free Bargain lists. Potter, 1314 McGee, Kansas City 6, Mo.

24 BUSINESS OPPORTUNITIES

\$25 WEEKLY working two hours daily. No canvassing. No Manufacturing. Lycke, Box 2471, Cleveland 12, Ohio.

OPERATE profitable home business selling merchandise by mail. Fast sellers. Large profits. Powell Service, 5713 Euclid, Cleveland 3, Ohio.

RECAST old batteries into new. Latest achievements. Battery Laboratories, Minneapolis.

BOOKKEEPERS—Operate your own simplified "Dollar-A-Week" Bookkeeping & Tax Service. Full or spare time. Details free. Ellis, Box 203, Cedar Grove, N. Car.

SPECIALTY Manufacturing, the big money business that can be operated anywhere, start on a very small capital; we supply dependable formulas and complete instructions; get interesting Free booklet, "Money-making Opportunities in Specialty Manufacturing." Howard Robinson, Ph. G., 1300-B S. Ohio St., Sedalia, Mo.

137 PLANS to make money local, mail order. Particulars free. Elite Co., 220-A Grand St., N. Y.

GOOD Paying Business Silvering mirrors, plating autoparts, reflectors, bicycles, bathroom fixtures, etc., by late methods. No tanks or shop required, outfit furnished. Free Booklet. Gunmetal Co., Ave. E, Decatur, Illinois.

"SELL By Mail! Books And Novelties! 35 different items! Large Profits! Catalog free. Elfco, 432 N. Wells, Chicago 10.

GO in magazine renewal and subscription business. Pays big—Repeat orders come automatically. Supplies furnished. Get free catalog and commission list. Write today. McGregor Magazine Agency, PS-11, Mount Morris, Ill.

START home business making statuettes, plaques, artificial marble flooring, liquid marble, flexible molds, metallizing baby shoes. Amazing profits. Folder Free. Creative, 236-M, Winnetka, Illinois.

START Your own electroplating business, highly paid, uncrowded field. Learn at home in spare time. Send postcard for free electroplating booklet and proof. Plater-Hyde, Room 521, 432 "F" Street, San Diego 1, California.

COIN Machines earn big money! Machines are now available at \$11.75 that can earn as high as \$7 weekly profit. Place machines in stores, hotels, filling stations, etc., and your income starts immediately. Routes can be operated in spare or full time with no experience needed. We'll tell you how and send you a catalogue describing our nut, candy, gum and postage vendors, also scales, amusement games, etc. Write immediately to Parkway Machine Corp., (Z) 623 W. North Ave., Baltimore 17, Maryland.

MANUFACTURE Yourself: Cleaners, Polishes, Cosmetics. Formula Catalog free. Kemico, 10, Parkridge, Ill.

CONVERT hand mowers to power mowers—sell the handy-dandy lawn mower conversion kits. Easily installed on any make mower in 3 hours. Used with any small gasoline or electric motor (Maytag, Power Products engines) in stock. Quick delivery. Kits can be purchased with or without engines. Fits 16 to 20 inch mower. Dealers Wanted. Write for Details, Le Claire Manufacturing Co., Le Claire 2, Iowa.

CLASSIE Novelty, large profits dime. Martin, PS, 57 Hart, New Britain, Conn.

YOUR own plastic business at home. Produce costume jewelry, novelties, statuettes. Liquid Plastic, liquid marble. Flexible molds. Write for free book. American Trades, Box 89-B-1, Cincinnati 29, Ohio.

TRAVEL anywhere anytime. Earn \$85.00 week up. Be your own boss. No experience necessary. Less than \$5.00 investment required. Literature free. Traveler, La Grange 2, Indiana.

METALLIZE Baby-Shoes. New Ideas. Particulars Free. Krall, Box 8087, Pittsburgh 16, Penna.

RE-NEW Leather and Leatherette—Make cloth into imitation leather with plastic discovery called Leather-New. Opportunity to make real profits taking care of sales resulting from national advertising. Write for Free sample of Leather-New covered material and complete deal. 704 Land Bank, AX, Kansas City, Missouri.

COLORGLAZED Concrete Pottery made without molds. Patented method. Cemetery products, novelties, tiles. Basement leak-sealing. Money-making projects. Booklet, details free. Men only. National Potteries, Grand Rapids, Minn.

UNPAINTED Plaques, Figurines, Emerson, 142 Bay 14 St., Brooklyn 14, N. Y.

MAKE Big Money. Start Own Real Estate Brokerage Business. Our big authoritative manual tells how. Price \$2.00. Money back guarantee. Literature free. Realtor, Box 2983, Houston 1, Texas.

IF you'd like your own, high income but easily learned office business, write for free details today. Cole Associates, Syracuse 2, N. Y.

TYPEWRITER Repairing instructions, standard typewriters. Webbers', Box 1008, Canton, Ohio.

UP to \$1500 yearly selling by mail in spare time interest you? New ideas and plans every month. Details free. Idea of Month Club, Box 118-B, Baltimore 18, Md.

MAKE profits in mail order business. Astounding plans describing method sent free. D. Jimton Service, Lock Box 1373, Mobile 8, Ala.

BUYERS Wanted for plaster novelties and Religious statuary. Painted—unpainted. Retail—wholesale. Write today for free information. Bing Products, 88-X7B Broad, Boston 10, Mass.

LIQUID Marble—make in any color. Soundproof Plastic Flooring. Flexible molds. Cast novelties, plaques, statuary. Big Money—your own business. Catalog Free. Write—Bing Products, 88-B4A Broad St., Boston 10, Mass.

RUBBER Moulds for casting novelties. Latex for making Molds. Use thoroughly tested and approved products. Eastern Latex Laboratories, Box 153, Mattapan 26, Mass.

LIQUID Rubber for making flexible molds. Cast novelties. Sample bottle 25c, free literature. Chaney, 1130 E. 16th St., Jacksonville 6, Fla.

\$40 WEEKLY spare time, own Home business. Many plans. Literature Free. Carroll Service Co., 521-F North Pine, Little Rock, Ark.

HOW and Where to obtain capital. Particulars free. Star Service, Wapakoneta, O.

HOW To Set Up and Run A Mirror Shop! Resilver Mirrors. For Price Write—John Sprinkle, V90, Marion, Indiana.

WHITE Liquid Rubber for making flexible molds! Quick drying! Safe! For home, classroom, or industry! Quart \$2.00. Gallon \$5.95. Full instructions! Beginners booklet on molding and plaster casting 25c. Free with order! Plastercraft Supply Company, 1406 East 43rd Street, Cleveland 3, Ohio.

RAISE Earthworms. Instructions \$1.00. W. Huffman, 391 Pleasant Lake, Rives Junction, Mich.

MANUFACTURE costume jewelry at home for profit, hobby, therapy. Free wholesale supply catalogue. Instructions. Florida Supply House, Bradenton, Florida.

HANDYMEN—Earn money home operating Community "Fix-it" Shop. Write Stafford, 708 Rawlings, Carbondale, Ill.

OPERATE Profitable Mail Order Business. Splendid opportunity. For details write J. Kavas, 54 Seigel Street, Brooklyn 6, New York.

METALLIZING Baby Shoes makes you money! Learn this simple, profitable business from nationally recognized authority. Little investment—large returns! Get professional "Know-How"! Free details. Joseph B. Kushner, Metal Finishing Engineer, Straudsbury 33, Penna.

GENUINE Natural Latex for rubber molds. Only two coats necessary for thick molds. Make money reproducing statuary, plaques, novelties. Low cost. Write Major Chemical Co., 131B Inman Street, Cambridge 39, Mass.

SUCCESSFUL Mail Order Business at home! Free "How" Information. C. Scott, 282 West 117th Street, New York 26.

AMAZING new invention! Screw Holding Screw Drivers! Remove, hold, insert screws hard-to-get places! Exclusive distributor appoint salesmen selling to stores, factories. Millen Mfg., 684 Miller Bldg., Boston, Mass.

WOULD you pay 3%—first \$350 made? Color-illustrated book "505 Odd, Successful Enterprises" free! Some offer occasional "day off." Work home. Expect something odd! Pacific-7, Oceanside, Calif.

RED Seal Rubber Company Develops New Compound! Genuine Natural Latex Base! Fully Guaranteed! Introductory Offer for \$3.00—Complete Mold Making Course plus Quart of Red Seal Latex! Free Literature upon request, 116 Nassau St., New York 7, N. Y.

OPERATE profitable mail order business. Write, Walter Service, 4159-B East 112th, Cleveland 5, Ohio.

EXCLUSIVE Distributor. Plasticized beauty-protection for auto finishes. Used like polish. Must fin. own stock. Plasticize, 2254 NW 62nd St., Miami, Fla.

GET it for them wholesale. Be community buyer nationally-known merchandise: radios, refrigerators, washers, sweepers, typewriters, etc. Savings up to 50%. This pleasant easy work can earn up to \$5000 year. Get details today. Kraft, Aurora 9, Mo.

MAIL Order Businesses, Franchises, Distributorships, bought and sold. Write for Free Bulletin of Exclusive Opportunities. Turnipseed, Inc., Box 681, St. Louis, Mo.

BIG Money In Vending Machines—Smallest capital start brings immediate profits that build permanent profitable business. Starting instructions free. Becker Vendors, 105-P Dewey, Brillion, Wisc.

MAKE Rubber stamps, plaster novelties, metallize baby shoes, silver mirrors. Catalogue of "20 Ideas" free. Universal, Box 1076-B, Peoria, Ill.

NATURAL Rubber Latex, Extra Thick. Sample Jar 25c. Literature Free. W. Wooley, 111-B Donald, Peoria, Ill.

\$126.50 GUARANTEED weekly. Send \$1.00 deposit. Stannette, 277 Madison Street, New York 2.

FELLOW Workers—Down with Bosses—Start own business—Be Independent—Booklet describing 137 Tested Plans, free. P. Padney, 307 York St., Jersey City, N. J.

TYPEWRITER Repairmen urgently needed. Earn \$40 to \$50 weekly spare time. Our easy to learn home study course teaches how to repair typewriters. Write for free information. Houston Typewriter Repair Service, P.O. Box 5357, Houston 12, Texas.

DO it with Sea Shells. Attractive Jewelry. Novelties. Big Profits. Instructions. Supplies. Werts, 1429-56th Avenue, Oakland 3, Calif.

MAILING postcards selling repeat merchandise is profitable. Everything supplied. Details free. Gordon Publishers, Box 23, Pawtucket, R. I.

QUICK Money! "Repairing Car Batteries." At home! Easy too! Write, Batteryman, Grand Junction 1, Colorado.

START a clock shop while clock repairing is booming. Our easy to learn home study course with pictures and illustrations teaches you how to repair all kinds of clocks. Information free. Houston Clock Shop, P.O. Box 5086B, Houston 12, Texas.

GET 400 Money making ideas, plans, formulas, Schemes. Folio Free. Formico Prod., Box 572, Dayton, Ohio.

OPERATE America's most popular low priced precision penny vending machine. Big profits. Be independent. Write for bulletin and prices. Stock shipments. Fielding Mfg. Co., Desk PS12, Jackson, Michigan.

CONCRETE Block Business. Get into a profitable building line now. Millions of homes needed. Block business increasing each month. Be the first in your community. Madison Equipment Co., Madison, Tenn.

GET Hundreds Money Making Deals, business ideas, plans and manufacturing. Amazing folio free. Austin Mail Service, 5538 Lexington, Chicago, Ill.

ELECTRICALLY Inclined men. Amazing illustrated literature free, proving \$100-\$250 weekly possible installing, maintaining fluorescent lighting. Rebuild fixtures for excellent profits. Make beautiful lights for 50c each and less. Free sample materials. Write Willis Fluorescent Service, 101 York Street, Brooklyn 1, N. Y. Dept. C.

NOW you can operate a successful mail order business without big capital. Our National All In One Mail Order Selling Plan tells you how. Details Free. Yaniv Distributors & Publishers, Box 2453, Youngstown, Ohio.

MEN and Women! Repaint Venetian blinds. Build machine. Little cost. Make money. No experience needed. Complete plans \$3.00. G. E. Service, Box 749, Long Beach 3, Calif.

BABY Shoes preserved. Formulas, instructions. \$1.00. Novelty Bronzing, Box 56, Hyde Park 36, Mass.

LEARN Piano Tuning, Repairing, at home. Tremendous field! Piano parts, tools furnished. Established 1935. Empire School of Piano Tuning, 606-A East University Ave., Champaign, Ill.

RUBACREAM! Natural Rubber Latex! Makes molds quicker! Thicker! Free Sample convinces! Castcraft Studios, 509-S Fifth Avenue, New York 17.

\$46 FROM Square Foot Plywood; Jigsaw necessary. Write; Woodart, Bridgewater, Mass.

HOME Workers wanted to hand-spin Angora Wool. Either Sex. House of Angora, S9, Springfield, Ill.

BEST Tested Money-makers. 68 page book, 40,000 words 25c. Tannehill, 745 N. Central Ave., Chicago 44, Ill.

BOOKKEEPERS: Operate own book-keeping service. Part or Full time. Free course of instructions. A. J. Hawthorne, Public Accountant, Decatur, Ala.

BASKETS wholesale to the trade only. Hardware stores, General Stores and etc. Write for price list. Durham's Basket Market, North Branch, N. J.

NOW you can raise your capital. Resourceful information sheets of wholesale sources, printing, valuable formulas, etc. 10c postpaid. Satisfaction guaranteed. Wayne Burger, Baltic, Ohio.

PROFITABLE Letter Shop operation. Information Free. Ronald Wollard, Newark, Ohio.

RUG and Upholstery Cleaning. 10 Pounds of Dytex Upholstery Shampoo @ 50c per pound starts you in this lucrative business. Instructions are included. No special equipment required. Dytex Chemical Co., 145 Cray St., Providence 3, Rhode Island.

RESILVER mirrors at home. Solution for two square feet postpaid for \$1.00. H & F Products, Box 144, Linden, N. J.

INCORPORATE in Delaware. Many advantages. Free details. Corporation Fiscal Company, Inc., Delaware Trust Building, Wilmington, Delaware.

FLEXIBLE Molds to order, also originals. Professional course manufacturing molds and cast novelties. Latex, lacquers, flocks, flocking equipment, supplies. Plastics, Box 1574, Boston 4, Mass.

SWEET Money: Make perfume for personal use or resale. Details Free. Write Recce, Dept. "P" 900 E. Central Ave., Orlando, Florida

COLORADO'S Fabulous Oil Boom attracts thousands. You too want shot at \$1,000—\$5,000—\$20,000 on investment of \$140? Want your profits in lump sum? Learn how Vincent put in \$1500 and found himself \$76,000 richer in 8 weeks. I'll attend to everything. Write today. Dyer-PS, 1835 Champa, Denver, Colo.

BIG profits and your own business casting new 1948 Metal Toys and Novelties. Latest scale model Autos, Original Ashtrays, Savings Banks, Water Pistols, etc. Enormous wholesale and chain store demand keeps manufacturers busy. No experience or special place necessary. Write for details and illustrations of patterns needed. Metal Cast Products Co., Dept. E, 1696 Boston Road, New York 60, N.Y.

MODERN Popcorn Machines. Big Profits Box 712 Corsicana, Texas.

HAVE you a product, plan or idea that could sell by mail? We will Distribute, Finance, Manufacture, Ship - on liberal profit-sharing basis. Write fully today! House of Frederick, 4 South St., Stamford, Connecticut.

MAKE big spare or full time earnings in Mail Order, Easy Pleasant work. Small Capital. Interesting details Free. Holdens, Dept. 127, 4903 Rhodes Avenue, North Hollywood, California.

AUSTRALIA Wants Veterans including merchant marine eligible Aust G.I. benefits; passage part paid unlimited jobs full particulars one dollar. Lee, Box 245, San Anselmo, Calif.

"MAIL Order Magic"—Free monograph sent anyone interested in mail selling! Crompton, Box 2567-S, Hollywood 28, Calif.

RUBBER—Genuine "India" Makes molds (One Day) Pint \$1.50, Gallon \$7.00. Rubber Products, Southport, Chicago.

NATIONALLY Advertised perfume deals details. L'Oripahs, 764 So. Normandie, Los Angeles 5, Calif.

88 MONEY MAKING OPPORTUNITIES

ELITE Collection describes 137 money-making plans; local, mail order. Particulars free. Elite Co., 220-A Grand St., N. Y.

DETECTIVES Earn Big Money. Experience unnecessary. Particulars free. Waggoner, P-125, West 86th, N. Y., N. Y.

SEWING Machine Repairmen make big money lifetime. Start neighborhood shop. Complete repair manual, covering all makes. \$1.98 postpaid. Money Back Guarantee. Sewmachine Serviceman, Hamilton 10-H, Ohio.

METALLIZE baby shoes. Further information free. Metal Crafts, Box 356-R5, Tampa 4, Fla.

START Your own business! Big money manufacturing novelties, plaques, statuary. Free catalog. Write Bing Products, 88-B4B Broad Street, Boston 10, Mass.

EARN Money At Home!—Steady Income!—Colliers Course tells How!—Sample Lesson 25c (coin). Write Successful Income Builders, 508-B, Hollywood, Calif.

NOVELTY Manufacturing—if you have garage or basement write for interesting, money making story, our system has given many financial independence. Plastex Products, 711 Laguna St., San Francisco.

MAKE Perfume, Make Money. Free book tells how. Lawson, 21 Joiner, Saint Augustine, Florida.

PRIZE Contest Fans Reap Rich Rewards. Enclose 3c stamp. National Contest Bulletin, Box 2685-S, Miami 31, Fla.

21 POPCORN, Candy Apple, etc. Formulas. All money-makers. \$1.00. We can supply equipment. Concessions Supply Co., Dept. "B", Box 133 Sta. "B", Toledo, Ohio.

MANUFACTURE costume jewelry at home for profit, hobby, therapy. Free wholesale supply catalogue, Instructions. Florida Supply House, Bradenton, Florida.

BIG money manufacturing floor tiles. Details free. U-Build-It Service, 206-A West Wilder, Tampa, Florida.

WANT \$30 To \$50 A Week in spare-time money? Book called "How to Start Your Own Business" shows opportunities in 101 fields including radio, autos, agencies, rental services, handicrafts, etc. Shows how to start making money right away, how to build up to life independence. Full facts and figures. Send \$1.98 to Foremost Books, 353 Fourth Avenue, New York 10, N. Y. Satisfaction or money back.

"100 ITEMS to make and sell at home." Holmes, Oaklandon, Indiana.

START Flocking—Spray beautiful Plush Finish on Everything. Easy. Profitable. Inexpensive. Supplies, Equipment, Instructions. Coast Industries, 1511 W. Manchester, Los Angeles 44.

WOULD You pay 3%—first \$350 made? Color-illustrated book "505 Odd, Successful Enterprises" free. Expect something odd! Pacific-8, Oceanside, California.

AGENT or exclusive distributor for cigarette lighter manufacturer. MacGregor, Tahoe Valley 15, Calif.

EARN Money Evenings, copying and duplicating comic cartoons for advertisers. Adservice, Argyle (2), Wisconsin.

EARN Up To \$2,000 year, inventing simple items. Special cash markets. Hendrickson, Argyle (8), Wisconsin.

"THERE'S Big Money In Junk," and repairing Car Batteries! Batteryman, Grand Junction, Colorado.

ELECTRIC Clocks are everywhere you go, buildings, homes, parking-lots, factories. Repairs increasing. Our easy to learn course with pictures and drawings teach you how to repair these clocks. Electronic Supply Co., Box 2350-B, Houston 1, Texas.

CASH In Now with this tested Mail Order Profit Producer. "Advertising Tips On Selling By Mail" gives you a complete outline of mail order operation. Send your \$1.00 now. Special Small Capital Mail Order Plan Free. The Brown Company, Box 1412, Wichita, Kansas.

900% PROFIT. Stamping key checks, dog tags, Social Security Plates. Arrington's, LaGrange 5, Georgia.

START Home Business making beautiful, authentic wood carvings from inexpensive models. Sell gift shops, department stores, novelty stores, etc. No experience necessary with new, amazing "Carvit" duplicating machine. Cash in on your spare time. Dumore Co., Dept. M-S9, Racine, Wisc.

"I AM a Preacher, nevertheless made over \$3000 in 30 days honestly, legitimately. I believe many others can, also. Will you risk a dollar bill for the secret? This is not a gag. F. J. Winder, 4638 N. E. 34, Portland 11, Oreg."

WIN contest money. General Contest Magazine gives hundreds of tips. Lists current contests and rules. Sample 25c. General Contests, 1609-A East 5th, Duluth, Minn.

400 MONEY Making Plans, Ideas, Formulas, Success schemes. Folio Free. Formico Crafts, Box 572, Dayton, Ohio.

1947 GIGANTIC Directory of Opportunities, Advertisers Supplies, Sources, Trade Information. Mail Order Ideas, Products, Wholesalers. Valuable tips—just published! Descriptive literature Free. Wilkin & Co., Hillsboro 2, Ohio.

START toy factory making fascinating Top-O-Copter. The top that flies. Wood or plastic. 25c coin for plans. W. Darst, Leonard, Texas.

WIN Contest Prizes send 25c for guaranteed results. Winacontest, 22 Westlake Ave., Auburn, N. Y.

DISTRIBUTORS, Salesmen, Hottest Fluorescent Sign Deal in country. Callas Company, 2832 Hamilton, Detroit 1, Mich.

"GET into big paying field, free information. Milton Berman, Box 241, Monticello, N. Y."

A \$100-A-MONTH hobby at home! No soliciting, no mail order, no meeting people. Easy, enjoyable pastime. Details, 25c (refundable) Laura Dickson, 808-PS Elizabeth St., Anderson, S. C.

MAKE money by use of new, safe, sure and secure method installing gutters on homes and buildings. No wire, nails or rivets used to fasten gutters know how \$5.00 L. Brune 2319 Rousseau St., New Orleans, Louisiana

3 MONEYMAKING formulas 25c Bland 1382 W. 36 St. Los Angeles Cal.

SHELLCRAFT! Make beautiful seashell jewelry. Income - or - Hobby! Large illustrated catalog! Supplies, instructions, 10c Postage (Buy Direct From Manufacturer) Pace's Box 279-S Bradenton, Florida.

59 FORMULAS, PLANS, ETC.

137 MONEY-making plans, also formulas for salable products. Descriptive booklet free. Elite Co., 220-A Grand St., N. Y.

FIVE Greaseless Soap Formulas, Ten Herb Formulas, Five Money Making Tips. Everything 25c. Sunrae, Ogema 7, Wisc.

RESEARCH: Any formula \$1. Guaranteed. "Research", Box 161, Knoxville, Tenn.

10,000 FORMULAS and Trade secrets. Free Literature. Stillmans, 555 Kingston Ave., Brooklyn 3, N. Y.

GUARANTEED 1000% profit, 200 tested cosmetic, perfume, polish, plastic etc. formulas plus chemicals to start you off in business. Unlimited possibilities. Don't pass this opportunity by. Send dollar bill. Devons Labs, Box 82, Times Square Station, New York 18, N. Y.

"NEED Chemists? Products duplicated? Formulas? Analyses? Consulting Scientific Company, Swarthmore, Pennsylvania."

100 SINGLE ingredient formulas, 25c. Tes-co, Box 189-SG, Wilkes Barre, Penna.

"PHOTOGRAPHS anywhere, three formulas \$1.00. "Photo", 2437 Hollywood Ave., Toledo, Ohio."

106 PLASTICS

POLISH Plastics with Flame. Complete kit and instructions. Nothing additional needed. \$2.00 postpaid. Barnett Specialty Co., 5104 Hollywood Blvd., Hollywood 27, Calif.

MAKE money assembling our pre-fabricated plastic kits. Sample Kit 50c. Catalog free. Fabros, Box 156, Station F-2, Buffalo 12, N. Y.

MAKING Money With Plastics, \$1.00. G. B. Going, Box 1544, Muskogee, Okla.

NEW Liquid plastic. Clear, colors. Cast without heat. Embed flowers, insects, coins. Saw, drill, carve. Manual tells how. Send \$3.50 (West Coast, Canada, Mexico \$3.75) for complete 20 project kit including one pound liquid Castolite. Castolite, Dept. P-24, Box 211, Kenilworth, Ill.

INTERNAL Carvings, Drills, Dyes, Jewelry Findings, Tools, Plexiglas, Masked Sheets 12"x12" 1/16"—\$1.00, 1/8"—\$1.25, 3/16"—\$1.55, 1/4"—\$1.85. Include 10% postage. Rods, Tubes, Dyes, Cements, Buffing Compounds. Free Listings, Craft Plastics, Somerville, New Jersey.

INTERNAL carved Swans, Bluebirds, Goldfish, Butterflies, etc. Pins, \$1.50, Roses Costume Jewelry sets, \$1.50 less findings. Roses 2" cubes, \$2.00. Crystal Floral Novelty Co., Somerville, N. J.

"PLASTICS—Sheets, rods, tubes, all colors; dyes, supplies; findings. Illustrated fabricating manual, prices, 10c. Lucite sample, 35c. Gem-O'-Lite, Box 686G, North Hollywood, Calif."

PLEXIGLAS Sheets 1/8" x 9" 10" 62c; 9" x 11" 75c; 10" x 12" 84c; 13" x 16" \$1.60; 1/4" x 8 1/2" x 12" 90c; 6" dia. x 12" x 1/4" wall clear cylinders \$1.60. Send postage. Julian Rhodes Muench Co., 1527 W. Alabama, Houston 6, Texas.

PLEXIGLAS bargain, 2 1/2 lbs. masked pieces, postpaid \$2.00. Satisfaction guaranteed. Transplastics, 295 Huntington, Boston 15, Mass.

INTERNAL carving outfit, \$4.75. Rapid injector press, \$22.50. Technicraft, 1156 Commonwealth, Boston 34.

LEARN Internal Carving of Plastics for pleasure and profit. It's easy, exciting to carve flowers, animals, landscapes of colorful, thrilling beauty in solid Plexiglas plaques and cubes. Send 10c for complete instruction folder, jewelry findings catalog, and big plastics price list. Plastic Parts, Dept. H-6127, 1157 S. Kingshighway, St. Louis 10, Mo.

33 CHEMICALS AND APPARATUS

CHEMICALS-Lab, Supplies New Catalog 10c. Mel-Glo Chemical Co., 258 Fourth Avenue, Brooklyn 15, N. Y.

SPECTROSCOPE For quick chemical analysis \$3.00. Cutting Co., Box 457, Campbell 2, California.

LUMINOUS Paints will glow in dark. Six colors. Fairmount Chemical Co., 136 Liberty St., New York City 6.

LEARN Chemistry at home, from the House of Winn. Home of Supplies for student Chemists. New idea chemical and apparatus outfits for Home Experimenting. Semi-Professional Microscopes and accessories. Send 10c for retail catalogue. Established 1931, John H. Winn, Dept. 611, 124 West 23rd Street, New York 11, N. Y.

NEW laboratory Supply Catalog of Chemicals and apparatus. Contains over 5000 items with illustrations, 212 pages. Send 50c. Standard Science Supply Co., 1232 No. Paulina St., Chicago 22, Ill.

FORMULAS!! French, German, English Scientific prescriptions. Hygro-Meters, chemical gardens, Modern Plastics, etc. Handbook, 25c. "Formco", Box 876, State College, Penna.

FREE Catalog: Chemistry, Mineralogy, Biology. Tracey Laboratories, Box 615, Evanston, Ill.

CHEMICALS and apparatus for industrial, analytical, and private laboratories. Complete supply service for correspondence school students. Send 3c for catalog. Dept. M-26, Biological Supply Co., 1176 Mt. Hope Ave., Rochester 7, N. Y.

CHEMICALS, ounce quantities, apparatus, catalog 10c. Fleischer's Laboratories, Everett 49, Mass.

HANDBOOK for Chemical Experimenters, Hundreds of Experiments; Illustrated, 50c. Experiment Booklet, 15c. Supply Catalog, 5c. Reading Scientific Co., Reading, Penna.

COMPLETE Supply Catalog, 10c. Pilgrim Chemical, 348-AA Edith, Salt Lake City 4, Utah.

CHEMICAL Magic Entertaining. Mystifying, educational. Complete set 50c. Wholesale price \$3.00 per dozen, 10 dozen \$25.00. 100% profit selling friends. Dytex Chemical Co., Cray St., Providence, R. I.

INTERESTING Catalogue Rare Elements. Chemicals small quantities, processes. Dime refunded first order. Vicar Laboratories, Established 1916, Guerneville, Calif.

LABORATORY Supplies, Chemicals, Glassware, etc. low prices. Large catalog 15c. Microscopic Stain Catalogue 20c. Both for 25c. National Scientific Company, Established 1908, 2204 W. North Ave., Chicago 47, Illinois.

1000% PROFIT guaranteed. 200 tested plastic, polish, cosmetic, perfume etc. formulas. Plus chemicals to start you off in business. Don't pass this opportunity by. Send \$1.00 bill. Devons Labs, Box 82, Times Square Station, New York 18, N. Y.

FORMULAS, Sold, Tested, Chemical, Metallurgical Analyses, Consulting Service, Heat Treating, Freehold Testing Laboratory, Box 352, Freehold, N. J.

SPECIAL Christmas offer, 24 different chemicals, \$3.50. Neatly bottled. Met & Co., 160 Hillside Avenue, Nutley 7, N. J.

68 HELP WANTED

INTERESTED In Latin America & Foreign Employment??? \$1 brings copyrighted Foreign Service Directory listing firms with interests in Construction, Oil, Mining, Aviation, Transportation by Personnel expert and Hot List of Companies hiring. Global Reports, P. O. Box 883, Dept. PS, Hollywood 28, Calif.

EARN Up To \$480 Month part or full time keeping books for small firms. Simplified System. Write Tax-Saver System, Dept. S, Ft. Worth, Texas.

BOYS Wanted, Over \$50 week! Sell name plates for front doors. Write National, 214 Summer, S., Boston, Mass.

5 AGENTS WANTED

SELL Personalized soap. Name on every cake. Ideal for gifts. Get sample offer. Dunbar Soap, New Brunswick, N. J.

GOOD Paying Business Silvering mirrors, plating autoparts, reflectors, bicycles, bathroom fixtures, etc., by late method. No tanks or shop required, outfit furnished. Free Booklet. Gunmetal Co., Ave. G, Decatur, Illinois.

"BIG bargains for big profits. Over 100 sensational values. Men's used suits \$2.00, pants 35c, topcoats \$1.25, Overcoats \$2.00, shoes 20c. Experience unnecessary. Free wholesale catalog. Superior, 1250-A Jefferson, Chicago 7."

LICK After-war layoffs; Start own business; home, office. Booklet describing "Collection of 127 Tested Plans" free. Elite Co., 220 Grand St., New York.

AGENTS. Sell finest Food Products direct to homes. Successfully sold for 25 years. Big profits. Powerful combination sale plans make sales easy. Permanent repeat business. Samples furnished. Live territories open to Distributors. Mother Hubbard Products Co., 4139 Grand, Dept. PS, Chicago.

START Your Own Business on Our Capital. Always your own boss. Hundreds average \$6,000 to \$25,000 annual Sales. We supply stocks, equipment on credit. 200 home necessities. Selling experience unnecessary to start. Wonderful opportunity to own pleasant, profitable business backed by world-wide industry. Write Rawleigh's, Dept. L-U-PSC, Freeport, Ill.

MAGIC Cleaner and laundry soap deal. Hotter than a firecracker. Big Profits. Sample free. Uko, 5007 Irving Park, Chicago.

JUST Out! History of World War II. Huge Volume. Popular price. Authentic text. Official photographs. Big profits. Riverside Book Company, Iowa Falls, Iowa.

EXCELLENT Sideline for printing and advertising salesmen. Decalomania name plates in small quantities. Great demand. Also, make money with our line of Automobile Initials and Sign Letters. Free Samples. "Ralco", XL-Roxbury, Boston 19, Mass.

BE renewal headquarters for all magazines. Christmas gift sales starting now. Big profits. No experience. No capital needed. Free catalog tells how. Write: McGregor Magazine Agency, Dept. PS-5 Mount Morris, Ill.

AGENTS—Big Line Including Food Products. Fast selling premium and bargain deals. Low prices. Send card for big outfit offer with gift Ho-Ro-Co., 2726 Dodier, St. Louis 7, Mo.

SCHOOL Seniors—Earn 40% commission selling classmates America's most beautiful Graduation Name Cards. Largest selection. Outsells all others. Send for free sample kit. Printcraft, 1425 E. Elm St., Scranton 5, Penna.

AMAZING New Glow in the Dark House Numbers, Switch Plates, Decals, Pictures, Religious Articles, etc. Factory Representative wanted. Wonderful Opportunity. Free samples. Madison Mills, 303 Fourth Avenue, New York, N. Y.

SCHOOL Seniors: Sell classmates superb Craftcards for super profits. Write Craftcards, Box 235 (AH), Pittsburgh 30, Pa.

BIG Profits selling used clothing. Operate from home, auto or store. Men's Suits \$4.00. Overcoats \$4.00. Field Jackets \$2.00. Ladies' Coats \$1.50. Army Shirts \$1.50. Other Big Bargains. Catalog Free. Kadetsky & Son, 702 Barber Street, Dept. 10, Chicago 7, Ill.

BRAND New!! "Circline" Fluorescent sweeping country! Fabulous profits selling stores, offices, homes. Also exclusive Fluorescent table lamp. Complete line modern fixtures. Rush name for free sales kit, sample offer. Rose Co., 529JB South Franklin, Chicago.

"EASY Money, for Individuals representing Manufacturer of well-known, quality cigarette lighter. Unusually good proposition. For details send name and address to Box 57, Buffalo 21, N. Y."

SELL new-used clothing from home, auto, store. Men's suits \$1.17. Leather Jackets 85c. Overcoats 62c. Dresses 17c. Ladies Coats 38c. Other Bargains. Catalog Free. S&N, 565A Roosevelt, Chicago.

MAKE More Money selling personal initialed individualized belts, buckles, cap badges, tie holders, 2000 emblems to choose. Big profits, whole or part time. Write today special outfit offer. Hookfast Specialties, Box 1425, Dept. 7, Providence, R. I.

SELL Delicious Candies, Nuts, Gum. Immediate delivery. Write Casterline, 2031-SC Sunnyside, Chicago 25, Ill.

STRANGE "Dry" Window Cleaner. Sells like wild. Replaces messy rags. Liquids. Simply glide over glass. Samples sent on trial. Kristee 116, Akron, Ohio.

AGENTS—300% profit selling genuine gold window letters; stores and offices. Free samples. Metallic Letter Co., 437 N. Clark, Chicago.

\$1. STARTS you in business. Sell DeLuxe ties, 100% wool interlining. Costs you only \$7.00 per dozen, you make \$5.00 Dozen. Send \$1.00 for special introductory offer two DeLuxe ties. Catalog complete line Free. Philip's Neckwear, 20 West 22nd St., Dept. P-17, New York 10.

ELECTRICAL Appliances and "Pressure Cookers". Now available. Selling like wildfire. Amazing Profits. Write quickly. Morris Mandell, Inc., 131-W W. 14th St., New York 11.

SELL oil burners for kitchen ranges. Great demand—terrific profits. Oil Burner Supply, Box 327, Cambridge, Mass.

GOLD lacquered Window Sign Letters. Large Sizes Penny Each. New Foils. Absolutely Beautiful. Free Samples. Atlas, 544 W. 79th, Chicago 20.

JOBS Open In Selling! Send name, address for Free copy Opportunity Magazine, listing hundreds of companies who need men now, full or spare time. Experience not essential. Opportunity, 28 E. Jackson, Dept. 18, Chicago 4, Ill.

DISTRIBUTORS Wanted For Unusual Products. Levine's, 15-S Boulevard Station, New York 59, N. Y.

NO Investment, throw rugs, big profits, good repeaters. Investigate this opportunity. Warren Rug Mills, Box 243-L, Phillipsburg, New Jersey.

SCHOOL Seniors!!! Your postal will bring our wonder, Kwick-Sell Catalog of popular Graduation Name Cards. Biggest profits \$! Only firm giving free souvenir chest and Card Case. Don't miss out! Hurry that postal!! Craftcards, Box 235 (M), Pittsburgh 30, Pennsylvania.

AGENTS show new, hot \$1 item to stores, sells-on-sight, free sample proves deal. 100% profit. Write or Wire: Presto Company, Dept. A-3, Glendale, Calif.

ABSOLUTELY Free! Big package actual sample fabrics and style presentation of dresses, lingerie, hosiery, etc. Take orders. Commissions big. Send no money. Melville Co., Dept. 4570, Cincinnati 3, Ohio.

LOOKING for Something To Sell? Then you need our New Product Bulletin. Red hot items for local or mail order selling. Gives source of 100 newest items. Issued monthly. Sample \$1.00. Details Free. Tichenor's Products, 526 So. Western Ave., Dayton 7, Ohio.

ADVERTISING Book Matches—Cash In On Political Campaigns—sell Union Labels matches. Cuts for all businesses and political parties—Free powerhouse selling kit—low prices—protection guaranteed on repeat orders—Cash Commissions. Superior Match Co., Dept. P127, 7530 Greenwood, Chicago.

START Mailorder Bookshop—Everything furnished. 25c brings booklet, samples, exciting ideas. General Publications, Ossining 1, N. Y.

SILVER Plating Liquid. Apply with cloth. Cleans, silverplates, polishes, one rubbing. Genuine silver. Renews silverplated ware. Also silverplates brass, copper and some other metals. Female and male selling representatives wanted. Part time or full. Splendid profits. Exclusive territory. Sells by showing and demonstrating. Retail and wholesale. NuProcess Products, Aurora, Ill.

AGENTS—Make big money with low- priced Plastic Table Covers. Saves on laundry bills. Over 100% profit. Samples Free. Earwell, 330 So. Wells, Chicago.

CHOOSE Your Own Future, with import- ing-exporting. Sell-buy abroad make 1,000% profit. Master world trade principles quickly, easily. Send \$1 for two Bulletins supplying addresses of hundreds overseas firms seeking connections. Money refunded if unsatisfied. Benko, 246-S Fifth Ave., N. Y. 1.

SELL Ultra blue stock signs to stores, 1000 slogans, comedy, general, religious. 7 x 11, cost 6c, sells 35c. Make money. Sample free. Lowy, 8 West Broadway, Dept. 328, New York City (7).

AGENTS Wanted for our Slot Machines and coin operated amusement games in every town and community. Sell to clubs and homes, or start a route. Webb Distributing Co., Dept. P40, 6 So. Kedzie Ave., Chicago 12, Ill.

FAST Selling Carded Auto Accessory and Other Items, write Steele Plastics Co., Ashland, Ky.

\$28-\$140. DAILY possible. Agents-Distributors, Domestic-Foreign. Flo-Glo Plastic Linoleum-Wood finishes. Acme, Box 404-ps, Mount Vernon, N. Y.

EARN Big Money Year 'round. Be a one-person-department-store. Take orders for shirts, ties, hosiery, lingerie, Household linens, etc. For information—Cooperative Merchandisers, Dept. PS1, 110 West 34 Street, N. Y. 1, N. Y.

SELL The New \$3.45 Electric Device everyone needs. To Stores or Individuals. Cash Daily. We deliver. Sample Kit \$2.00. Sibert Company, Newark 3, N. J.

WOULD you pay 3%—first \$350 made? Color-illustrated book "505 Odd Successful Enterprises" free! Proven! Work at home, office. Expect something odd! Pacific-6, Oceanside, California.

FREE Selling Kit, "Print O Press" Stencil Letter Duplicators. World's lowest priced \$9.95 up. Pays continuous profits with Supplies. Rush name, address. No investment. Professional Products, 42 Madisonville, Cincinnati.

"WORLD'S Latest" Sinco line of calen- dars and advertising specialties open for a few swift hard-hitting, experienced men who can qualify. Write today. N.W. Singleton Co., Dept. P.S., Salt Lake City.

\$221.90 IN One week—Unusual? Not at all! Just look at one week's earnings of these representatives. SWB \$247.84, JRS \$252.80, HMT \$242.75, HC \$252.93, HET \$319.38, OP \$442.40. Direct mail campaign brings hot leads right into your home. Remarkable product does part of 10 men's work—a "natural" during these labor problem days. Has perfect sales story—sells year 'round. As modern as radar! Free equipment offer! We extend credit, deliver and collect. No capital required—no experience necessary. You make big profit on first sale and full credit on repeat business. Every business, store, home, factory, etc., are prospects. Write John Porter, 2433 Indiana, Dept. 326, Chicago 16, Ill.

NO Money or experience needed. Spare or full time. Steady income writing orders guaranteed men's hose. Variety 20 styles. We deliver and collect. Liberal advance profit. 33% cash bonus. Write today for complete free sales outfit. Kentcraft, Dept. WS, 44 Court St., Brooklyn 2, N. Y.

FREE nylons given your customers if Kendex hosiery runs or snags within guarantee period! Sensational written guarantee amazes everybody. Three magic words, "Guaranteed Against Everything" enough to make sales. Earn wonderful income writing orders. We deliver and collect. Spare or full time. No money or experience needed. Liberal advance cash profit plus big cash bonus. Your name and address brings you complete free money-making sales outfit prepaid. Write today—start earnings next week. Kendex Co., Dept. 112, Babylon, N. Y.

EARN 40% Clear Cash Profit with fast- selling quality neckwear at \$1, \$1.50 and \$2. Finest, exclusive fabrics, latest patterns, expert workmanship assure many orders. Excellent side-line! Write Lomax Neckwear Co., Dept. A-14, 221 W. Lomax Place, Chicago, Ill.

HOT! Sell flying model helicopters wholesale or retail. Big profits. Details Free or send \$1.69 for sample. Robert Sales, Room 507, 727 Hennepin, Minneapolis, Minn.

FREE wholesale catalogue profitable quality home products. Beebe Company, 40 Whittier Road, Wellesley Hills 82-S, Mass.

BIG Profits. Sell Photo Enlargements. Photo Rich, 215 West 98th, New York.

A NATURAL! Big Money, selling new line one piece, Lace Plastic Tablecloths! Sizes to 54x108. Also Women's Aprons; Novel, Embroidered Cotton Pillow Cases. Free, "Interesting" details. Royalty, Box 748-L, Passaic, N. J.

MAKE Money At Home Like I Do! Write immediately. Duffy, Covington 5, Ky.

OPPORTUNITY—We have arranged to receive large quantities of beautiful South American hardwoods ready cut for Parquet flooring. Agents are needed for distribution. This is the first offer. Exclusive agencies only will be given in each area. Easily handled on part time basis. Bic-Keen, Inc., 1456 Penobscot Bldg., Detroit 26, Mich.

GORGEOUS Men's or Ladies' gift sets \$5.00 value \$2.00 postpaid Hilbor Products Chicago 9, Illinois.

BIG profits selling wallpaper treatment—no capital or experience necessary. For folder write Transglo, Little Neck, N. Y.

SELL printing. Lowest prices in America Adams-SP, 30 West Washington, Chicago 2.

SELL!! Balloons, Combs, Specialty Mer- chandise. Carleton House, Distributors, Texas City, Texas.

COSMETICS, Exclusive Territories Pro- tected, exceptional Commission, quality products, highly salable, amazing profits. Stephanie, 1280 Ontario, Cleveland, Ohio.

BOYS 14 to 17 Earn Christmas money now. Introduce and take orders for this fast selling novelty toy. Retail for \$1.00—Costs you 59c. Order your sample now. O. Marceau, 916 E. Third, Royal Oak, Mich.

69 HIGHGRADE SALESMEN

FREE—New 42 page Book Entitled "How To Become A Successful Direct Salesman", written by salesmen for those who want to become salesmen and earn up to \$100 and more weekly. Send penny postcard. Specialty Salesman Magazine, Dept. PS-10, 307 N. Michigan, Chicago 1, Ill.

POCKET Pal; the All Purpose Cutting Tool, Wagon Jobbers—Salesmen. Sell to retailers and jobbers, 50c seller. Steady repeat item. Exceptional profit. Sample 25c. Nelson Manufacturing Company, 222 W. Kellogg, St. Paul 2, Minnesota.

ADVERTISING Book Matches—World's largest direct selling Mfr. of advertising Book Matches offers opportunity for profitable year 'round selling; Every business a prospect; No Exp. needed to start; Full or part time; Factory service; Low prices for high quality; Repeats; Sales Kit Furnished. Match Corp. of America, 3433-43 W. 48th Place, Dept. N-13, Chicago 32, Ill.

NEW Auto Accessory. \$8.50 seller. Big profits. Write Aero, 4836-S Joy, Detroit 4.

47 **EDUCATIONAL AND INSTRUCTION**

HAVE your own office! Many earn up to \$5,000-\$15,000 Annually. Learn credit-collection agency business by home study course. Experience unnecessary. Write for Free bulletin. No obligation. Franklin Credit School, Dept. 203-N, Roanoke 7, Va.

STANDARDS, Suggestions and Glossary for Engineers, Draftsmen and Students. 50 8 1/2 x 11 pages For Only \$1.50 prepaid. Monson Engineering Service, 4525 Bryan Place, Downers Grove, Ill.

LEARN trigonometry better — sooner. Master method instructions one week free. \$1 after. Other books, J. Ziemba, 6123 Orchard, Dearborn, Mich.

ACCURATE Mechanism—design, assembly. use. Johnson, 48 Roberts, Watertown, Conn.

BECOME a Doctor of Psychology or Metaphysics. Teach secret of contentment, happiness. Win degree of PsD. or MsD. Solve mental worries. Free book. College of Universal Truth, 5153-K N. Clark, Chicago.

EARN \$2.25 an hour in spare time. Easy-to-learn, low cost tuition, many jobs available. Write vanderBie School, 1258 A. So. Gramercy Place, Los Angeles 6, Calif.

WANT A Government Job? \$1,756—\$3,021 year. Men-women. Veterans get preference. Prepare Now for next examinations. Booklet—Sample lessons free. Write today. Franklin Institute, Dept. R-23, Rochester, N. Y.

BOOKKEEPERS! Increase your earnings. Operate your own simplified "Dollar A Week" Bookkeeping and Tax Service. Full or spare time. Details Free. No obligation. Ellis, Box 207-G, Cedar Grove, N. C.

BUILD Electric Motor—Kit. Illustrated instructions \$4. World, Box 81, Clifton, N. J.

CLINICAL Laboratory Technicians in great demand. We train you in your spare time, in your own home. You can practice while studying. Write for free catalogue. Imperial Technical Institute, Box 973-B, Austin, Texas.

VALUABLE information on your memory, famous feats of memory, free. Write today. Thor Books, CS-12, Box 1210, Chicago.

MEN: Add dollars to your paychecks! Technical training will boost your income. One of the country's only drafting school specializing in structural detailing, tool and die design, machine design, architectural drafting. Only men of ambition who want a good future need apply. G.I. approved. Cleveland Engineering Institute, 2324 Chester, Cleveland 14, Ohio.

WANT a good job? Or better one at higher pay? I'll tell you how to get amazing results quickly. Nothing else like it. Sampson, Box 388, Oklahoma City, Okla.

YOU can master mathematics. Universal School of Mathematics, 623 Story Bldg., Los Angeles, Calif.

EXPERT Bookkeeping. Easily Learned—15 Lesson course \$5—Introductory Lesson 35c—Bernard Buchalter, 1280 Ocean Ave., Bklyn, 30, N. Y.

39 **CONTESTS**

\$25,000, \$20,000 FREE!—Contests. You can win. Need help? Write. Research, 13 Earl St., Red Bank, N. J.

77 **LANGUAGE OUTFITS**

29 LANGUAGES by Linguaphone, Russian, Spanish, Portuguese—Direct Conversational Method for Mastering any language quickly, easily, correctly at home. Available under GI Bill of Rights. Send for free Book. Linguaphone Institute, 54 RCA Bldg., New York, CI 7-0830.

10 **AUTHORS SERVICE**

I WANT New Writers to cash hundreds of checks for \$1 to \$100, offered each month. The easiest way to write for pay. No previous experience necessary. Send for Free details. No obligation. Saunders M. Cummings, 467-S Independence Bldg., Colorado Springs, Colo.

25 **BUSINESS SERVICE**

MAIL Forwarded. 25c each letter. \$2.00 Month. Banas, Box 285-D, Syracuse 1, N. Y.

BUY for less. Enjoy buying advantages of huge corporations. Any item. Details free. Kelly & Co., 9544-R Whitcomb, Detroit 27, Mich.

"EXCLUSIVE Sales desired of suitable New Products. E. J. Ness, Northwest Distributor, Fergus Falls, Minn."

TO Whom It May Concern: We will represent you in all principal cities of the world. Representatives wanted. Will send you assignments immediately. James W. Farley, Citizens Building, Cleveland 14, O.

30 **CARTOONING, SIGN PAINTING, DRAWING AIDS**

"HOW To Make Money With Simple Cartoons"—A book everyone who likes to draw should have. It is Free; no obligation. Simply address Cartoonists' Exchange, Dept. 1911, Pleasant Hill, Ohio.

TALENT Test Free. American School Commercial Art, Box 8066, Dallas 5, Texas.

NEW Simplified Method Teaches Cartooning at home in your spare time! Fully illustrated. Same technique as used by world famous cartoonists. Money back guarantee. Only \$2. Roland Glenn, 1300 Thorndale, Chicago.

9 ALPHABET 3 Numeral Pattern Sets and Catalog \$1.00. Sign Letter Distributors, P. O. Box 101, Mineola, N. Y.

SIGN painting taught at home by an old master. Ben Kerns, Box 812, Greenville, S. C.

31 **CHALK TALK STUNTS**

CHALK Talks, Laugh Producing Program, \$1.00. Illustrated Catalog 10c. Cartoonist Balda, Oshkosh, Wisconsin.

136 **TYPEWRITERS**

RECONDITIONED Typewriters, Printing Devices, Office Appliances Supplies Dixie-graph, King, N.C.

93A **OFFICE SUPPLIES & EQUIPMENT**

CASTERS: Special offering of 2" Plastic Wheel Casters for Tubular Secretarial Chairs, etc. Net prices—100 sets or more, 90c per set; Less than 100 sets, \$1.10 per set. Shipped Prepaid. Dependable Manufacturing Company, 1908 California Street, Omaha 2, Nebr.

NEW Watches \$10.00; \$8.50 Ball Point pens \$4.25; Reynolds Bombshell \$1.25; Typewriters \$27.50; Duplicators \$9.95; Adders \$12.95. Business Service, 118 Spruce, Wichita, Kansas.

118 **RUBBER STAMPS**

3 LINES 40c. Pads 35c. Signatures \$2.40. Print-Right, Wauwatosa, Wisc.

RUBBER Stamps, all kinds. Catalogue 10c. Print & Stamp Co., Box 172, Boston 1.

110 **PRINTING OUTFITS, SUPPLIES**

"PRINTOMATIC" Selffeeding Post Card Stencil Printing Duplicators \$9.50 Up. Office Size Duplicators, Speedoprints, Hilcos, Excellographs \$33.41 Up. Literature Free. Pittsburgh Typewriter Supply, 336 WE Fourth Ave., Pittsburgh 22, Pa.

PRINTING presses, type, supplies. Send dime for complete illustrated printer's supply book, details and press samples. Kelsey, Inc., A-8, Meriden, Connecticut.

PRINTING Presses. Type, Supplies, Lists 3c. Turnbaugh Service, Loysville, Penna.

INEXPENSIVE home-made printing press. Details free. Novelty Shop, Downs-ville, Louisiana.

MAKE Your Own Plastoplate printing cuts. Simple, easy process. Plastoservice, Argyle 2, Wisc.

PRINTERS Are Made! Details Free. Printers, 7526 Metropolitan, Middle Village, N. Y.

HOME made printing press. Joseka, Box 140, Jersey City 3, New Jersey.

109 **PRINTING, MULTIGRAPHING, ETC.**

1000 BUSINESS cards printed prepaid \$2.50. Reliable Print Shop, 901 E. Jefferson, Louisville, Ky.

"PRINTING—Quality, reasonable prices. Business, personal stationery. State your requirements. Free estimates, samples. Westerkamp Printing Co., 1135 Spring St., Cincinnati, Ohio."

DISTINCTIVE Printing — Stationery, Checks, Cards. Reasonable. Samples, Prices Free. Stumpprint, South Whitley 2, Indiana.

500 6 3/4 envelopes \$2.35. Mango Printing Co., 555-B South 20th, Newark 3, N. J.

SEND 10c Now, for our 48 page price-list—Refunded first order. McCall Press (PSM), 1326 South 27th, Omaha 5, Nebr.

QUALITY Printing: Business, personal stationery. State requirements. Samples. Mero Products, 99 Morrison, Punxsutawney, Penna.

BUSINESS Cards 1000 \$2.95. Embossed. Ortiz, 1050 Fox Street, New York 59.

POSTCARD brings our samples, prices. Valley Print Shop, St. Elmo 7, Tenn.

BUY your printing wholesale! Lowest prices in America. Adams-SP 30 West Washington, Chicago 2.

98 **PATENT ATTORNEYS**

INVENTORS: Without obligation, write us for information as to what steps an inventor should take to secure a Patent. Randolph & Beavers, Registered Patent Attorneys, 340-A Columbian Bldg., Washington 1, D. C.

INVENTORS: Write for free brochure "Evidence of Invention." Labiner, World Building, New York 7.

INVENTOR'S Guide free on request. Frank Ledermann, Registered Patent Attorney, 154 Nassau St., New York 7, N. Y.

PATENT and Trade-Mark Practice before U. S. Patent Office. Validity and Infringement Investigations and Opinions. Booklet and form "Evidence of Conception" forwarded upon request. Lancaster, Allwine & Rommel, Registered Patent Attorneys, Suite 413, 815-15th Street N.W., Washington 5, D. C.

INVENTORS: Learn how to protect your invention. The United States Patent Office advises the inventor to engage a competent registered patent attorney or agent to represent him. We maintain a staff of registered patent attorneys ready to serve you in the handling of your patent matters. Special booklet "Patent Guide for the Inventor" form containing detailed information concerning patent procedure with "Record of Invention" form will be forwarded upon request—without obligation. Clarence A. O'Brien & Harvey Jacobson, Registered Patent Attorneys, 72B-G District National Building, Washington, D. C.

C. A. Snow & Co.—S-427, Snow Building, Washington 1, D. C. Registered Patent Attorneys. Write for information.

PATENTS—Trade marks. Irving L. McCathran, 316 McLachlen Bldg., Washington 1, D. C. Registered Patent Attorney.

PATENTS, trade-marks; copyrights. Sanders, 6430 Evans Ave., Chicago 37, Ill.

INVENTORS. For "Record of Invention" form, contact Carl Miller, Registered Patent Attorney, Woolworth Building, New York.

INVENTORS—Patent Laws encourage the development of inventions. The Rules of Practice of the U. S. Patent Office advises—unless an inventor is familiar with such matters—that he employ a competent registered attorney or registered agent, as the value of patents depends largely upon the skillful preparation of the specifications and claims. Write for further particulars as a patent protection and procedure and "Invention Record" form at once. No obligation. McMorrow, Berman & Davidson, Registered Patent Attorneys, 143-P Victor Bldg., Washington 1, D. C.

INVENTORS—Send today for "Detailed Patent Information" outlining preliminary steps to be taken toward Patent Protection, also convenient "Evidence of Invention" form. Victor J. Evans & Co., 241-P Merlin Building, Washington 6, D. C.

58 **FOR INVENTORS**

THE Inventor who believes he has a new and useful invention, and needs advice, should consult a competent registered patent attorney. Without obligation, write for full information on how to secure Patents and Trademarks. Randolph & Beavers, Registered Patent Attorneys, 340-E Columbian Bldg., Washington 1, D. C.

"INVENTOR'S Guide" free on request. Frank Ledermann, Registered Patent Attorney, 154 Nassau St., New York 7, N. Y.

HIGHEST Royalties and cash for inventions when we market them. Free booklet without obligation. Universal Marketing Co., 126 Lexington Ave., New York 16, N. Y.

INVENTORS: Avoid unnecessary expense. Write for free booklet explaining how our Consulting and Advisory Service can assist you in deriving greatest profit from inventing. Institute of American Inventors, Dept. 30-A, 1926 Eye St., N.W., Washington 6, D. C.

INVENTORS: Learn how to protect your invention. The United States Patent Office advises the inventor, unless familiar with such matters, to engage a competent registered patent attorney or agent to represent him. We maintain a staff of registered patent attorneys ready to serve you in the handling of your patent matters. Special booklet "Patent Guide for the Inventor" containing detailed information concerning patent procedure with "Record of Invention" form will be forwarded upon request—without obligation. Clarence A. O'Brien and Harvey Jacobson, Registered Patent Attorneys, 72A-K District National Building, Washington, D. C.

PATENTED. Unpatented inventions promoted. M. Joyce Humphries, 1424 Landtitle, Phila. 10, Penna.

INVENTORS— Patent Laws encourage the development of inventions. The Rules of Practice of the U.S. Patent Office advises—unless an inventor is familiar with such matters—that he employ a competent registered attorney or registered agent, as the value of patents depends largely upon the skillful preparation of the specifications and claims. Write for further particulars as to patent protection and procedure and "Invention Record" form at once. No obligation. McMorrow, Berman & Davidson, Registered Patent Attorneys, 143-M Victor Building, Washington 1, D. C.

INVENTORS! Have you good, patentable Ideas? Patent Agent Metzler, 11 West 42nd, New York.

I'D like to show you how I've sold my inventions—write for free literature—George Pearce, 47-R, Bartholomew Street, Peabody, Mass.

HOW to sell unpatented inventions. Charles Dimmick, 477B Adair St., Long Beach 5, California.

FILE Patents yourself, information free. Birsh, 712 Manhattan Ave., Brooklyn.

BRASS, Aluminum and Bronze castings made to your specifications. Send pencil sketch of parts wanted. Write today for prices. Sedlock, 2584 W. 25th Street, Cleveland, Ohio.

INVENTIONS Sold. Prior Patents May Kill Value Of Yours. Have Patent Office Search Made Cost \$6.00. Patent Applications Prepared. Protection Forms Free. Charles Morton, 11 West 42nd Street, N.Y.

INVENTIONS Wanted. Patented or Pending. Inventors Exchange (D), Hartford 1, Conn.

75 INVENTIONS WANTED

INVENTORS: Hundreds of manufacturers have requested our assistance in locating marketable new products. Complete information, free. Institute of American Inventors, Dept. 30C, 1926 Eye St., N.W., Washington 6, D. C.

INVENTIONS Promoted. Patented or Unpatented. Write Adam Fisher Company, 183-A Enright, St. Louis, Mo.

"INVENTORS— Booklet "Self-Testing Your Patent Or Invention" free on request. Avoid costly mistakes, wrong markets. Direct Contracts, 11106-B2 Longwood, Chicago 45."

MANUFACTURING & Promotional organization seeking new inventions for household or novelty trade. Penn Products Co., 35-54 73rd Street, Jackson Heights, N. Y.

SMALL Inventions wanted by manufacturers. I'll help you sell your invention. Write for circular. S. Hull, 7829 Euclid, Cleveland, Ohio.

"CASH or Royalty Paid for acceptable inventions by manufacturers. Write—John D. & Son, Box 3213—PS11, 285 Howard, Bridgeport 5, Conn."

PATENTED, unpatented inventions wanted. We have tremendous lists of manufacturers who may pay cash, royalties. Descriptive booklet free. National Invention Service, 1404-B Mitchell Street, Oakland 1, Calif.

99 PATENTS

INVENTORS: Test the commercial value of your patented or unpatented inventions, quickly and inexpensively. Write for free information. Institute of American Inventors, Dept. 30-B, 1926 Eye St., N. W., Washington 6, D. C.

100 PATENTS FOR SALE

PATENTED Cigarette Snuffer, also Butts. Can be made metal, Plastic, glass for household, automobile, airplane trays. E. C. Moulton, P. O. Box 324, Newburgh, N. Y.

WILL Sell or lease on royalty basis Pat. application pending new type of dice, write for free sample. O. J. Brandon, Broderick, Calif., Box 129.

82 MANUFACTURING

SMALL lot production. Aluminum castings; Stampings; Screw Machine. J and M Company, Burlington 2, Kentucky.

MODELS small lot manufacturing, metals, plastics, etc., Millburn, Burlington, Ky.

MANUFACTURER Wanted. New article cleans teeth easier, better and sooner than old method. Uses no paste, no powder, no liquid. Responsible parties desiring to market a very good new product, while patents are pending, contact Pavak Patent Products, Tuller Hotel, Room 244, Detroit (26), Mich.

87 MODELS, MODEL SUPPLIES

MOST complete Illustrated Catalog—"O-HO OO" Model Railroad Parts ever published. Send 5c for mailing. Selly, 1377 Gates Ave., Dept. 836, Brooklyn, N. Y.

MODEL Ship Builders! Are you looking for authentic, precision ship models? Send for richly illustrated fully descriptive catalogue in full color of famous ships of all kinds. Only 10c. Halesite Yacht Service Inc., Dept. C-36, Halesite, Long Island, N. Y.

SHIP and Yacht model fittings; blueprints. Send 25c for illustrated catalog No. 20—Listing hundreds of items. A. J. Fisher, 1002-2 Etowah Ave., Royal Oak, Mich.

SHIP Model Kits and Fittings . . . most complete stock in New England. Boucher, Fisher, Marine Model and Model Shipways fittings, blueprints and model yacht equipment at standard prices. Send 25c for new illustrated 1947 Catalog and price list. Dept. S., James Bliss & Co., Inc., 220 State St., Boston, Mass.

BUILD Model Ships, Railroads, Catalog 10c. Ideal, 21 West 18th Street, New York 11, N. Y.

SHIP Model and yacht supplies, complete large 64 page catalogue, 30c. Wm. Wild, 510 E. 11th St., New York City.

MINIJET Engine Kit now \$9.95 PP. USA Assemble real pulse-jet at home. Send MO today. No CODs. Minijet Motors Sales Company, Box 406, Pasadena, Calif.

FREE! Big Train Folder, packed with new Lionel cars, sets and accessories. Madison Hardware Co., 105-B East 23rd, New York 10.

STEAM boiler for model engines. Uses "Sterno". Withstands 300 lb. pressure. Cast bronze, silver soldered. Complete with gauge and fittings. \$22.50. Ross, B68 West Broadway, N. Y., N. Y.

MINIATURE steam engine. Working model. Brass and iron. Bore 9/16; stroke 11/16; weight 2 pounds. Assembled \$17.50. Ross, B68 West Broadway, N. Y., N. Y.

SHIP model catalog 25c coin. Roy Hancock, 323 Douglas Ave., Portsmouth, Va.

MODEL engines—steam and gasoline. World's most fascinating hobby. Build them yourself in your own shop, using your own tools. Send ten cents for illustrated catalog listing world's largest selection of miniature engine castings and drawings. McAded Models, 1313 So. Talman Ave., Chicago 8, Ill.

RAILWAY models, complete line. Combined HO and O gauge, catalogue, 35c. Walthers, 269 Erie, Milwaukee 2, Wisc.

POWER Models—steam and gasoline engines, steam traction engine, metals, tools. Catalog 35c. Charles Cole, Ventura, Calif.

"SHIP Models of lasting Beauty", Copper Sails, Construction Sets, assembled Models. Folder Free. Trade Wind Models, P. O. Box 171-A, Lakewood, N. J.

BRASS Gears and model supplies for the inventors. Send 10c for catalog. Pierce Model Works, Tinley Park, Ill.

STEAM engines—boilers—castings, Catalog 25c. Anton Bohaboy, 2297 Price, Rahway, New Jersey.

AUTOMATIC Switch Apparatus. Control each, few, all.—Signals, Toytrains, Photographs—\$2.95. Motors AC \$3.95. Am-Standard, 1208 N. 13th, Philadelphia 22.

87 A MOLDS AND MOLDING MATERIALS

BUSINESS at home casting plaster novelties. Generous trial kit \$2.00. Major Chemical Co., 131B Inman Street, Cambridge 39, Mass.

71 HOME CRAFTSMEN

BAND and jig saw owners, let your machine and hobby bring you profits, fun. Free Details. Nu-Art Designers, 34 Rosemont Rd., No. Weymouth, Mass.

GENUINE Leather scraps for leathercraft items, assorted colors, 6 pounds, \$2.00. Send 10c for sample. International Cushion Co., 515-BA No. Halsted, Chicago 22, Ill.

HUNDREDS Patterns: Plywood Novelty Furniture—Lawn Ornaments—Silhouettes—Weathervanes—Letters—Numerals—200 Craftsmen's Books & Booklets—Hundreds Decal Transfer Decorations. Other lines. Large Illustrated Catalog. Write Wo-Met Shop, Ashburn, Georgia.

DO-It-With-Leather. Profitable hobby. Send card for free booklet. Artcraft Leather of California, Dept. PS-12, 271 Twelfth Street, Oakland 7, California.

AMERICA'S most complete line of quality handicraft kits. Leathercraft, jewelry, shellcraft, wood inlay, plastics carving, cedar chests, metal tapping and many others. Send dime for most interesting catalog you ever read. Beaver Crafts Incorporated, 11558-L Wentworth, Chicago 28.

SPECIAL Offer: 80 full size toy, novelty and lawn ornament patterns only \$1.00. Lynds, Medway, Mass.

FREE Information Concerning Hobbycraft instructional helps. McKnight & McKnight, Bloomington, Ill.

GAS range from surplus materials. Build it yourself for \$30. Write for free literature. Ensco, 2055A Allen Avenue, Altadena, Calif.

SHELL Jewelry Supplies—Wholesale only. McFarland Plastic Co., Sarasota, Fla.

CELLULOID—New postwar, beautiful assortment. Mottles, opaques, onyx, pearls. Used by ring makers everywhere. One pound assortment—pieces approximately 30 sq. in. each. Price \$1.00. Please add 10c for postage. Craft Service, 337 University Avenue, Rochester 7, N. Y.

LEARN to make seashell jewelry; pins, earrings, hair ornaments, novelties. Book of instructions and designs free with \$2.00 or \$5.00 kits. Postpaid. Herbert Diamond Co., Box 4619, Miami 31, Fla.

WOODCRAFTERS—40 pictures of new woodworking projects. Folder 10c. Joanes, P.O. Box 141, Omaha 7, Nebr.

MAHOGANY—turning squares and blocks. Write for prices. M. W. Staylor, 307 S. Main St., Suffolk, Va.

"METALCRAFTERS! Send for catalog listing copper, brass, aluminum tools and supplies. Kit Kraft, 3203 W. Washington Blvd., Los Angeles 16, Calif."

SHELLCRAFT Jewelry Supplies. S. Werts, 1429-56th Avenue, Oakland 3, Calif.

EXPERIMENTERS! Interested in Electrical, Mechanical devices from war surplus? List Free. F. Siefke, Box 18, Station E, Buffalo, N. Y.

COPPER, Brass, Aluminum for tooling. Also tools and supplies. Catalog free. Kit Kraft, 3203 W. Washington Blvd., Los Angeles 16, Calif.

PLASTIC Wallet—complete material, equipment and instructions for making men's or ladies' plastic wallet. Nothing else to buy. Prepaid, U.S.A. only, \$2.00 (C.O.D. \$2.21) Details Free. Lakeshore Supply Co., Dept. PS, 534 Surf St., Chicago 14, Ill.

LEATHERCRAFTERS! Our design transfers eliminate tracing. Introductory offer; \$1.00. Sample 10c. Lampkin Artcrafts, Box 641-S, Culver City, Calif.

PLASTIC chair cane webbing Flats, Ovals, samples Dime. Fogarty Caner, Troy, N. Y.

SPECIAL 77 Full Sized Patterns, Lawn Ornaments, Toys and Novelties, \$1.00. Modern Woodcraft, Saginaw, Mich.

PLANS for toys, home and lawn furniture—jigsaw patterns. Illustrated folders 25c. Refundable. Summercraft Studio, 42 Vernon, Newton 58, Mass.

18 BLUEPRINTS AND PLANS

"BLUEPRINT Reading Made Easy"—ready reference book for reading any type blueprint. 596 pages, 463 pictures. Formerly \$8.95, now only \$1.98. Popular Science, Dept. 127-C, 353 4th Ave., New York 10, N.Y.

BUILD Powerful Motors From Scrap. Photos, Instructions \$1.00. Blakely's Electric Service, 375 Circuit Drive, Roseville, Calif.

23 BUILD IT YOURSELF

HOT Water Free—from Sunlight. System efficient any locality year 'round. Standard materials—easily built—low cost. Facts Free. Solar Water Co., Box 175, Dept. X, Coral Gables, Fla.

BUILD Concrete Block Machine. Easy. Inexpensive. New principle. 125 blocks hourly. Also build mixer. Details free. Clyde Lee, Mountain View 1, Okla.

"BUILD Cabins"—book offers complete instructions and plans for building your own cabin, lodge, tourist home, or wayside stand. 251 Pages, 200 plans and pictures. Only \$1.98. Popular Science, Dept. 127-C, 353 4th Ave., New York 10, N. Y.

SPECIAL. Full size patterns make over 100 toys. \$1.00. Complete plans for over 20 modern kitchen cabinets. \$1.00. Free list. Masterprint, White Building, Buffalo 2, N. Y.

BUILD concrete block machines, portable sawmills. Shop, farm, home machines. 70 plans. Catalog-Handbook Free. Nichols Equipment Co., Dept. 604, Purvis, Miss.

"CONCRETE Block Homes". 32 page booklet: drawings, instructions on how to build. \$1.00. H. C. Lightfoot, Civil Engineer, Richboro, Penna.

PORTABLE bar for home entertaining made from oak barrel mahogany finish with wheels. Complete plans \$1.00. Aluminum Marine Hardware Co., Auburn, N. Y.

CAR-BED Make it yourself. Inexpensive. will fit any 2 or 4 door sedan. Send \$2.00 for detailed plans. Simple and easy to follow. Martin's, Box 297, Upper Darby, Pa.

BUILD concrete block machine. 2 blocks per minute. Build concrete mixer. Easy, inexpensive. [See illustrated ad. page 38.](#) U-Build-It Service.

HOME Bars. 25 designs. Built-in, portable, cellarettes. \$1.00. Homecraft Plans, 7241 Madison, Dept. S-105, Kansas City 5, Mo.

"GIVE some boy or girl a real Christmas, with toys they'll love. Complete plans for making a mechanical horse, rides like a bicycle, and a beautiful rocking type cradle \$1.00 each. L. J. Davie, 1321 Pearl St., Sandusky, Ohio."

139 WATCH REPAIRING

WATCH and clock repairing increasing, complete home study course with drawings and pictures. Information free. Houston Chronometer and Watch Co., P.O. Box 1140B Houston 12, Texas.

95 OLD GOLD, WATCHES, ETC.

CASH for Old, Broken Jewelry. Highest prices paid immediately. Mail gold teeth, watches, rings, silverware, diamonds, spectacles. Satisfaction guaranteed. Information free. Rose Smelting Co., 29-Y East Madison, Chicago.

GOLD \$35.00 Ounce—Mail old gold teeth, diamonds, jewelry, watches—receive cash by return mail. Satisfaction guaranteed. Free information. Dr. Weisberg's Gold Refining Company, 1500-B Hennepin, Minneapolis, Minn.

NEW Guaranteed watches only \$8.95. Detailed literature free. Schaffer Company, Springfield, N. J.

WHOLESALE; Bulova, Elgin, Waltham, Gruen, Hamilton, Illinois, 7 jewel \$12.65 and up. Minimum 2 watches. Samples \$1.00 Extra. Free Catalogue, Dixie Mail Sales, Box 688, Athens, Georgia.

WATCHES. Xmas Specialties. enclose stamp. Pioneer, Box 14, Furlong, Penna.

76 JEWELRY

CERAMIC Jewelry Supplies. Bar Pins, ear screws, for ceramic and woodworkers, also, glass and sea shell assemblers. Free catalog. Philadelphia Badge Co., 1007 Filbert St., Philadelphia, Pa. Dept. E-1.

JEWELRY Findings. Lowest Prices. George Sassen, 154 Nassau Street, New York 7.

GENUINE Diamonds at out-of-pawn low prices from unredeemed loans and cash buys. We offer beautiful gems at far less than original cost. Shipped free for inspection. Appraisal. Write for Free list showing fine diamonds at amazing low prices. Lloyd J. Butler, President, Prudential Loan Association, 133 North Clark, Dept. K-127, Chicago 2.

STUN your Friends with Genuine, Sparkling, Brilliant-White Zircons. Cut, polished, mounted just like diamonds. Amazing diamond-like appearance. Top-quality. Hard for even experts to tell the difference. Beautiful settings 14K gold. Over 100 gorgeous latest-style rings to choose from. Attractive low prices. Send for Big Free Catalog. U. S. Zircon Syndicate, 139 N. Clark, Dept. ZH-127, Chicago 2.

OUT Of Pawn Genuine Diamonds direct to you at far below retail value. $\frac{1}{4}$ Ct. Diamond \$135.00 Value, only \$59.00. Write for Free Circular of other unredeemed diamond pledges \$5.00 to \$5000. Berman's Collateral Loan Bank, 636-38 W. Balto. St., Dept. PS-2, Balto., Md.

MANUFACTURE costume jewelry at home for profit, hobby, therapy. Free wholesale supply catalogue. Instructions. Florida Supply House, Bradenton, Florida.

PRECIOUS, semiprecious stones, plastic-metal findings, list 10c refundable with first order. Pickwick Findings, Box 780-E, Stamford, Conn.

MAKE shell costume jewelry at home. Complete supplies Kits. Catalog. See Display. Tropical Shell-Art, 2 North Third Avenue, Mt. Vernon, N. Y.

132 TOBACCO & PIPES

PIPE Carving Kits \$1.00. Seconds \$5.00 pipes 65c. Literature Free. Carvapipe, 2829-A Dixie, Hamilton, Ohio.

86 MISCELLANEOUS

FIREWORKS: Don't be disappointed. Get Famous Banner Fireworks with all the newest and startling effects. Giant Cannon Salutes that rock you like a crash of thunder. Whistling Devils with weird unearthly noises. Skyrockets that burst in majestic colorful display. Gasp in amazement as you watch the "Battle In The Clouds". Genuine Chinese Firecrackers. Over 200 pieces including Sparklers for the little tots. Retail value over \$11.25 for Only \$4.95. Rush order today. Any quantity. Send money order, bank draft or currency, no C.O.D.'s. Banner Fireworks Mfg. Co. Inc., Dept. 113, 446 Capistrano, Toledo 12, Ohio.

INCOME Tax bookkeeping for average farm simplified. Originated from actual farm problems. \$2.50. The Farm Bank Co., Colby, Kansas.

WHAT Shall We Believe? For free copy of 78 page digest of "The True Christian Religion" by Emanuel Swedenborg, send name and address to Swedenborg Foundation, Room 1648, 51 East 42nd St., New York 17, N. Y.

MEN! Large Size Shoes, Large Size Sox! We specialize in large sizes 11 $\frac{1}{2}$ to 16, widths AA-EEE, Oxfords, Hitops, Work shoes. Guaranteed extra quality. Free Catalog. Kingsize, 425, Brockton, Mass.

HULL Automotive Compass, for accurate road direction, brand new, \$2.50. Prisms for 6 x 30 Binoculars, brand new, \$1.50 each. Offset prisms to be attached to 7 x 50 B. & L. Binoculars, gives double the field of the ordinary 7 x 50 Binocular. Cost \$98.00, special \$25.00. Green sunshades for Binoculars, size 6 x 30 and 7 x 50, snap on type, value \$7.50, special \$1.25 per pair. Forward money order. No C.O.D. shipments. Send coin \$1.25 for Third Annual Edition of Gun Digest together with our complete catalog of new and used guns, ammunition, rifles, binoculars and powder flasks. Our separate catalog 25c. Public Sport Shops, 13 S. 16th Street, Philadelphia, Penna.

SENSATIONAL new movie release! "Miss America, 1947" 8mm., 50 ft., \$2.00; Kodachrome, \$7.50. 16mm., 100 ft., \$4.00; Kodachrome, \$14.75. Big catalog, (81 subjects), 25c. World In Color, Box 392, Elmira, N. Y.

GET Lots Of Mail: Name Listed Three Directories 25c. Harvey Teeple, Decatur, Ind.

QUESTIONS About Our Locality Answered 25c each. Trading Post, Stoney River, Alaska.

"FOR Farm and Home use, a compact kit of industrial adhesives is offered for \$1.98 prepaid." Plastic Rubber Products Co., 127 Hudson Street, Hackensack 7, N. J."

ART Photos in colors. Unretouched Stamp for list. Griffin's Studio, Laurens, S. C.

TOPS! Lifetime Ballpoint Fountain Pen \$1.00—Free Literature. Novelty Enterprises, Dept. 24, Box 2341 Terminal Annex, Los Angeles 54, Calif.

GOLD—\$70 an ounce possible soon. Free booklet on panning gold, instruction book-supplies. Old Prospector, B-70, Dutch Flat, Calif.

LOCATE any article manufactured \$1.00. Business Service, 1101a Kingshighway, Shreveport, La.

FREE literature how to locate buried treasure and minerals. Fisher Laboratory, Inc., Palo Alto, Calif.

"STOP looking further, New Combination Two-Way Mail Order business. Free information. United Mail Order Bureau, 1310 N. Wells, Chicago, Ill."

PEN, Pocket, Hunting Knives—Large Selection—Lowest prices—Free price list—Knifemaster, 1441 Prospect Place, Brooklyn, N. Y.

CHRISTMAS Gift Genuine Calf Leather Zipper Key Cases, \$1.50. Favorite Locksmith, 824 East 149th St., N. Y. C.

ART Photos! Sample 50c, 3 for \$1.00. Post Office Box 2011, Phoenix, Arizona.

LOVELY Pin-Up Girls, Real, Actual Photographs, 10 for \$1.00, Sixty different \$5.00. M. Wilkins, 417 Hill, London, Canada.

FOOT Sufferers—Get quick relief with Kindschi Foot Balancers. Thousands of satisfied customers. Free Literature tells How. Kindschi Foot Appliances, GI, 321 W. Jefferson, Dallas.

YOUR Good Hat all droopy in the rain? Protect it with our waterproof plastic cover. Satisfaction guaranteed. Only \$1.00. Send hat size. Bestyet Distributors, 545-HD Fifth Ave., N. Y. 17, N. Y.

NEW, automatic fire alarm. No wiring, no batteries. Satisfaction guaranteed. \$6.75 postpaid. Robiorg Sales, Mansfield, Mo.

STEAM Engineer's Examination Questions, Answers, \$1.00. John Savinkoff, 1179 Cedar Ave., Trail, B. C., Canada.

BEEWAX, one pound pure beeswax completely postpaid \$1.00. Norman Sharp, Fishers, N. Y.

RECEIVE Giant mails, samples magazines two-year listing, \$1.00, 9-month, 50c, 3-month, 25c. Stanford, 6220-N 16th, Philadelphia 41.

FIREWORKS, send \$4.95 for assortment of over 200 pieces, get price list. Frank Patterson, Hawesville, Ky.

ART Studies Of The Prettiest Models From The Heart Of Hollywood. Send \$1.00 For Sample Poses 5x7. State Age. Wilson Of Hollywood, P. O. Box 348, North Hollywood, Calif.

SIX (different) leading mailorder magazines, 20c. American Directory, Robstown 4, Texas.

HYPNOTIZE Anyone! Get the most perfect, easily learned, modern scientific course of "Genuine Hypnotism" in the world! Fully illustrated. Only \$1.00. Money back guarantee. Fowler, Box 1284, Boston 4, Mass.

GIANT flowers, fruits, vegetables, grow in water quickly, easily for profit or pleasure. No hot house. All year round. Full instructions and chemicals. Send \$1.00 bill. Devons Laboratories, Box 82, Times Square Station, New York City 18.

EXPERT 14x9" Charcoal Drawing of you in thick paper. Just send any sizes Clear photo of you and \$3.00. Beautiful resemblance or money back guaranteed. Mok's Studio, 617 H St. N.W., Wash. 1, D. C.

FREE Girlie Photos. We're so sure that we have the best photos and the loveliest girls that we want to send you a free sample set. Just send 25 cents to cover cost of mailing and handling, etc. Print your name and address clearly and we'll ship this terrific sample set. But hurry. Merit Photo Studios, Box 137, Washington Bridge Station, Dept. 712, New York 33, N. Y.

SAVE money, save clothes. Direct from inventor and manufacturer to you, generous size bottle of liquid Rustess. Use on cotton, silk, rayon materials. Removes ugly iron rust stains. Price \$1.00 cash, money order, or personal check, to H. Landis, 3941 Thomas St., Sun Village, Chester, Pa.

BE a good conversationalist! Practical, easy course teaches you how, \$1.00 complete. Nankers Institute, Box 1222, Colorado Springs, Colorado.

ACTUAL photos South Pacific action, native girls. 18—\$1.00, 80—\$4.00. Novelty Sales, Wolfpit Avenue, Norwalk, Conn.

59A FOR SALE—MISCELLANEOUS

SALE—First Quality spar varnish. Original cost \$6.50. Now postpaid \$4.10 per gallon. \$1.13 per quart. H & F Products, Box 144, Linden, N. J.

GIVE her a beautiful personalized pin for Christmas, silver plated \$1.00 24 K. Gold plated \$1.50. First name engraved. L. J. Davie, 1321 Pearl St., Sandusky, Ohio.

TURBO-SUPERCHARGERS built for Thunderbolts and other war planes—now at a fraction of the original cost. Fascinating fun for mechanics who like to experiment. Practical too—adaptable to pressure blower jobs. 2 sizes—\$25, \$35. Write Silver Steel Co., Racine, Wisconsin.

138 WANTED MISCELLANEOUS

MERCURY—Highest prices. Free Containers. Write Mercury Terminal, Norwood, Mass.

ANYTHING bought—sold—traded. Free list. Buyers Bulletin, P. O. Box 415, Evansville, Ind.

57 FOR THE HOME

"AIRGUIDE" Indoor-Outdoor Thermometer. Handsome scientific instrument shows outside temperature indoors. Ideal gift. Circular free. \$6.00 postpaid. Trade Winds, 727 30th Street, Rock Island, Ill.

COLD Floors? Real foot comfort with the floor spot heater 1102 size \$7.95. Iver Electric, Coopersville, Mich.

VELVETEEN Xmas Stockings with sequined name \$8. Box 712, Corsicana, Texas.

"REPLACEMENTS" Stoves, Furnaces, Firepots, Grates, Linings, Fireclay Magic, Royal Oak 128, Mich.

101 PERSONAL

PSORIASIS Sufferers: Has everything failed to bring even temporary relief from scales, lesions and itching? Then write today for Free important information. You needn't invest one cent! Pixacol Company, Dept. S, Box 3583, Cleveland, Ohio.

CIGARETTES—Popular Brands \$1.39 a carton, delivered. Minimum order five cartons. Send check or money order; Pem Co., 5041 Pembridge Avenue, Baltimore 15, Md.

RUPTURED? Positive comfort, no understraps, no steel, no elastic. Write Smith Manufacturing Co., Preston, Ontario.

HOW You Can Find Out! Information discreetly developed, any matter, person, problem anywhere. Personal-business assignments, representations, undertaken. Nationwide. Officially Licensed and Bonded Service established 1922. Reasonable. All inquiries confidential. William Herman, 170 Broadway, N. Y.

FALSE Teeth hurt? \$1.00 "dynamic reflex" exercise strengthens, ends tender gums or money back. Dentex Co., Dept. 7, 624-2A SW., Great Falls, Montana.

GETTING Bald? Losing hair? Have dandruff? New scientific method using sulfanilamide is helping men all stages of baldness. Write today for free, confidential guidance on how to restore scalp health. Eugene Burt, State and Hohl, Kansas City, Kans.

HAIR Falling? Dandruff? Write Trichologist, 139 Lewis Street, Phillipsburg, N. J.

ALCOHOLISM is a Disease amenable to our treatment. If this evil threatens your home, job or business, Do Something Now! Write for Free Folder. Established 50 Years. The Murray Institute, 620 S. Tenth St., Minneapolis.

MATRIMONIAL—Sweetheart Magazine, 50c, 6 mos. \$1.00, Yr. \$2.00. Barwood, 2037-E 42nd, Astoria, N. Y.

BEAUTIFUL Glamour Girl Photographs. 10. \$1.00. List included. Wineholt, Woodbine 23, Penna.

UNUSUAL, Amusing Novelties, samples 10c. Modern Products, Box 2, New York 2.

INFORMATION for single people by Human Relations Consultant, University Graduate, Dr. B. Long, Box 375, Los Angeles 53, Calif.

"AVOID Baldness"—write for Booklet How to Save Hair, Correct Dandruff, Falling and Graying Hair. M. D. Bayer, P. O. Box 424, Hollywood 28, Calif. Dept. PS.

TOP Secret of Healthy, Wealthy, Wise, Immanuel Science, Columbia City, Ind.

TRUTH About Mind Power! 20 Years research. Startling, concise, authentic. Amazing results! Complete \$1.00. Saunders, 435 North Peninsula, Daytona Beach, Fla.

UNSUCCESSFUL? Dissatisfied? Earnings Low? Get the Bestyet Success Course! Includes tested principles. Sample lesson \$1. Satisfaction guaranteed. Details free. Bestyet Distributors, Room 907, 545 Fifth Avenue, N. Y. 17, N. Y.

NIFTY Shirt Holder helps hold shirt down pants up. Simply wonderful. Send dime. Nifty Sales, Box 812, Oakland, Calif.

"EVOLUTION And Blood Tests." 25c. Christian Evidence League, Malverne, N. Y.

AMAZINGLY effective Swiss Wonder Salve for Cuts, Boils, Carbuncles, Infections. Draws out poisons as it heals. Price 25c. five for \$1.00. Wolff Laboratories, Box 2865, Cleveland 16, Ohio.

CHRIST'S Birth; Genealogy 25c bulletin, Box 87, Cathedral Station, New York 25.

CONFIDENTIAL New York Mail-Address, Receiving, forwarding. Write: Arlington, 131-R West 42nd, New York 18.

MEXICAN Law, General Practice Attorney, 1203 Arizona Street, El Paso, Texas.

BUY Vitamins Direct, Amazing Savings, Money Back Guarantee, Our 9th year! Postcard, Matoska Products, White Bear Lake, Minn.

LETTER instructions, treatments, any problem. Metaphysical practitioner and teacher \$10.00. Iona Wachel, PsD., D.D., Delaware, Iowa.

HAPPINESS Ahead In 1948. Lonely, single people write for descriptive, illustrated booklet. Enclose 10c (coin). Hollywood "400", Box 2349-P.S., Hollywood 28, Calif.

1 ADVICE

EVERY Family can have Optimum Health. Name each Ailment. Send \$2.00 total cost. Health Club of America, 2219 N. 54th, Seattle 3, Wash.

INTERESTING Mental Analysis, Membership including Literature \$50.00. P. O. Box 801, Ottawa, Canada

2 ADVERTISING

ADVERTISE: 24 words, 40 Newspapers \$3.50. Lists Free. Advertising Bureau, 229-P Dixon Blvd., Uniontown, Penna.

24 WORDS in 64 Weeklies \$4.96, J. Darnell, 730 Hays, Jackson, Tenn.

ADVERTISING sensation! Reach 2,200,000 families—\$28.00 inch. Helpful ratebook (Newspapers, Magazines, Mailing Lists), advertising assistance—free. Chicago Advertising Agency, 20-PS West Jackson, Chicago 4.

WILL increase your volume of business through superior Mail Order Ads for National Advertising. New ideas. Free estimate! Gary Ruben Advertising Agency, Peoples Bank Building, Indianapolis, Ind.

66 HANDWRITING ANALYSIS

ATTENTION! Handwriting analyzed. State age. Enclose \$1.00. Otty Kling, 2240 Selma Ave., Youngstown 4, Ohio.

130 TAXIDERMY

FINEST Glass Eyes; Taxidermy Supplies. Catalog Free. Elwood Company, Dept. 235, Omaha 2, Nebraska.

45 DRAFTING INSTRUMENTS

SAVE on drafting materials. Free catalog. Draftsmen's Supply Co., 32 North Wells, Chicago 6.

129 TATTOOING SUPPLIES

TATTOOING Outfits, Supplies, Illustrated List Free. Zeis, 728 Lesley, Rockford, Ill.

120 SCIENTIFIC SUPPLIES

LABORATORY Supplies, Chemicals, Glassware, Etc. Low prices. Large Catalogue 15c. Microscopic Stain Catalogue 20c. Both for 25c. National Scientific Company, Established 1908, 2204 W. North Ave., Chicago 47, Ill.

27 A CANDY MAKING

MEN—Women—Start Candy kitchen in your own home. Big profit. Folder Free. Thompson Co., Dept. PS, Baldwin, Mich.

MEN—Women—"Most Everybody Likes Candy." Learn to manufacture Professionally at home. (Our 38th year.) Ragsdale Candies, East Orange, N. J.

142 WOODS

TEXAS Ebony, America's Most Beautiful Lathe Turning Wood. Large piece, \$1 Prepaid. Sample, Dime. Information on Southern Woods, Stamp, Starcraft 2, Edinburg, Texas.

81 A MAGNETS

ALNICO Magnet—Lifts Ten Pounds! \$1.00. Catalog 3c. Ronald Eyrich, Box 849, Milwaukee 1.

TWELVE Alnicov Magnets, 100 experiments, \$3.00. Experiments, 25c. Disc Magnet, \$1.00. Eljay, Box 891, Newark 1, N. J.

134 TREASURE FINDERS

METAL Detectors, The Very Latest Circuit, Free Literature, Hedden Metal Detectors, 538 North Homewood Avenue, Pittsburgh 8, Penna.

M-SCOPE Metal Locator fully guaranteed and unsurpassed in efficiency. New featherweight models. Time payment plan. Free literature, Fisher Research Laboratory, Inc., Palo Alto, Calif.

SEEK Buried Treasure. Methods, mysteries, devices explained. Circulars free. Century Press, Box 151-D, Glen Ellyn, Ill.

SURPLUS Army mine detectors. Complete with batteries; \$26.40. Highbridge, 343 Canal St., New York 13, N. Y.

TREASURE Hunters! Radically new Goldak locators. New featherweight Model 101 weighs only 11 pounds! Revolutionizes location of Gold, Silver and Minerals. Money-back guaranteed superior any other. Write The Goldak Co., 1544 W. Glenoaks, Glendale 1, Calif.

42 DETECTIVES

DETECTIVE Training, Phillips Secret Service, 1917C, N. Kenneth, Chicago 39, Ill.

DETECTIVES—Work home—Travel, Experience unnecessary. Write Wagoner P-125 West 86th, N. Y., N. Y.

BE A Detective—Send for price list of self-instructional courses at reduced prices. Perkins Publications, 300-C Brandies Theatre Building, Omaha, Nebr.

89 MONUMENTS

BUY a monument or sell them for us. Agents wanted everywhere. Big catalog Free. Marble-Granite Factory, Oneco 50, Florida.

74 INFORMATION

20 PRACTICAL Art Tips 15c. W. Clair, 44 Linden Avenue, Lansdowne, Penna.

93 NAME LISTS

LATE Mailing Lists! Guaranteed accurate. All classifications. Write Business Service, 1101a Kingshighway, Shreveport, La.

84 MILITARY INSIGNIA

FREE—3 Military Emblems, with Catalog 10c. Hobbyguild, X35 West 32, N. Y.

SAVE 85% UP TO

in WAR SURPLUS... SENSATIONAL VALUE!
at "GADGETEER'S HEAVEN"
IN MANY ITEMS WE HAVE THE WORLD'S LARGEST SUPPLY

BC 306-A NEW SIGNAL CORPS TUNING UNIT
In heavy alum. case with black crackle finish-16"x10"x8". Velvet vernier dial knob, calibration 0-100, with locking assembly. Switch - 5 position with knob. 4 1/2" diam. coil with three others inside, and movable induction tuning coil. **WORTH MANY TIMES MORE \$1.89 ea.**

NEW TRANSMITTER TUNING UNIT
Heavy crackle finish alum. case - 17"x8"x8". Master unit & power amplifier parts: Velvet vernier dial knob, calibrated 0-100 (plus lock), master oscillator tuning TU-5B dials, worm gear driven (plus lock), a 1 to 4 and a 1 to 6 switch. Also variable and mica condensers, R. F. Chokes, tapped coils, etc. **\$1.89 ea.**



MESS TRAY 6 COMPARTMENTS
Rustless, Stainless Steel. Can be used for cooking as well! Ideal for restaurants. The perfect companion for that vacation trip, barbecues, picnics! Saves dishwashing. **79c ea.**



CANTEEN
Gl. 1 qt. aluminum. Porcelain lined & covered. Plastic screw top chained to body. For campers, hikers, fishermen, etc.
Slightly used but perfect **45c**
Cup (fits around canteen and snaps onto belt) - **19c**
CANTEEN COVERS
Heavy felt lined, shoulder type with adjustable strap - **29c** Belt snap-on type **19c**



COMPASSES

- #151 Marching, lensite, with luminous dial **\$1.69**
- #152 Matchbox, both jewel & liquid floating dial **39c**
- #153 Jeweled Pocket Watch Compass #153 **\$1.19**
- #154 Wrist strap Compass **69c**



AIRCRAFT CABLE
Alloyed steel, rust resistant. 3/16" diam., 21 ft. long, with turnbuckle ends **99c each**
On Reels
1/8", in any length..... **4c per ft.**
3/16", in any length..... **5c per ft.**

#420 GOGGLES NEW ALL PURPOSE
Type Shatterproof.
Poloroid Lenses, Sponge Rubber Frames, 2 Sets of Flexible Lenses, Adjustable Head
Band with Case
Swell for Skiing, Motor Cyclist, etc. **59c**



RADIO HEAD SETS
EXCELLENT CONDITION. LOW IMPEDENCE.
AN-BH-1. WITH LEATHER SPONGE RUBBER PADS..... \$1.00 ea.
Throat mikes **\$1.00 ea.**
Voice Filters, FL-8-B. Noise eliminator. **\$1.50 ea.**



PLEXIGLASS DOMES
15"x19 1/2"x6" deep. 1/4" thick.
Can be used for home hot-house, fish bowl, wash-bowl, ornamental light. Can be flattened in oven and will make flat sheets, 15" x 19 1/2" x 1/4". Weight 3 1/4 lbs.
Also 200,000 lbs. of other plexiglass sizes and shapes.
#700 **\$1.69**

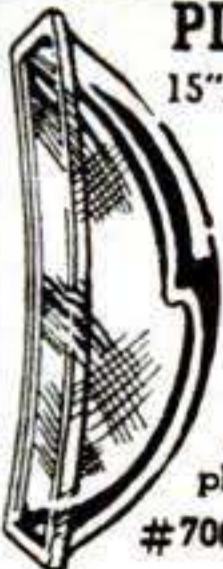

TEAR SHAPED PLEXI DOME
Overall length 21," width at widest point 11," at base 4," 6" deep. **\$1.39 ea.** #70-1-A



#148 Used, but in Good Condition #149
3,000 P. S. I. Capacity. Up to 400 P. S. I.
\$12.45 \$10.95



#148 AIRCO and VICTOR OXYGEN WELDING GAUGE AND REGULATOR
Regulation up to 400 P. S. I.
#148 VICTOR ACETYLENE WELDING GAUGE AND REGULATOR
Regulation up to 50 P. S. I.
#155 VICTOR CUTTING TORCH **\$15.75**
Type #400SS. Used, but in good Condition



MICARTA TUBE
M-1
Ideal for Insulation or Bushing Stock. 36" x 1/4" wall x 1" O. D. Original use was for trailing antenna - F 10. Use for towel rack, souvenir displays, shafting spacers, bearings, etc.
In original carton. **59c ea.**



PILLOWS
CURLED CHICKEN FEATHERS
28" x 17" **99c ea.**
Blue & white ticking. New, but still Renovated and Sterilized, in accordance with Laws of California. #424



NEW SKIING GOGGLES
Colored lens. Your protection against wind & glare of dazzling snow. Motorcycling, etc. **24c ea.**
A Terrific Value at



NEW HUNTING KNIFE #307
6" chrome vanadium blade
4" handle, leather grip.
In leather sheath.
\$5.98 Value For Only \$1.69



#313 BOAT FENDER-21 in. long
5 in. diam. Protection against docks for small boats.
\$6.50 VALUE A STEAL AT \$1.95
9/16" JUTE ROPE
3 Thread Strand.
Right Lay. 50 Ft. **79c**
7/8 SISAL ROPE
50 Ft. **\$3.59**
5 lb. Ball 3/16" Hemp
Twine Treated **\$1.48**



ANOTHER "SCOOP" NEW, K-21 AIRCRAFT CAMERA
(5" by 7")
Eastman Kodak Lens, F 2:5, 7 in., 178 mm., 5x5. E. M. 1215.
With filters for haze, and night operation. 24V motor and all drives for operating this amazing camera. Graflex Mfg.
A \$500 Value for \$75.00 Ea.



16 MM MOVIE CAMERA
Magazine Loaded - Battery Driven. Completely converted to Civilian use. Handy
No Winding - Includes 24 volt Battery, View Finder, Switch and Cord.
A \$200.00 BUY FOR ONLY \$53.95
This Camera Mfg. to rigid Gov't. specifications by leading camera mfgs. Magazine of 50 ft. super XX kodak film.
(does not include processing). **\$1.25**



FLYING HELMET
#407 - Fleece-lined winter - **\$1.59**
#407 A - Summer weight **69c**
Ideal for cycle drivers, racers, sportsmen. Used, but in excellent condition.



OXYGEN MASK
A-14 Demand type. Slightly used, but perfect. **\$1.95 ea.**
A terrific deal with "mike." **\$2.50 ea.**



#910 NEW AIRCRAFT ALUMINUM BUCKET SEAT
Use for boats, jeeps, tractor seats, etc. 17" x 18" seat, 18" x 24" back. Rib enforced. Adjustable height tube mounting. Wide. high back gives excellent support. Easily installed. Shipped in original carton.
You'll appreciate the buy at **\$4.95 ea.**



CUSHIONS
New leather cushions of finest pig-skin color, yellow. Filled with kapok. Will float! For tractors, jeeps, boats, cars, as well as home use.
Size - 22 1/2" x 17" x 1 1/2" thick.
At fraction of Gov't. cost... **\$2.95 ea.**



FOR THE FREEZE THAT'S COMING!
AIR CORPS FLEECE LINED LEATHER JACKET
1/3 to 1/5 Gov't Cost! (approx.)

- Made to last.
- Full sheepskin pelt.
- Fleece-lined collar.
- Leather taped seams.
- Full length zipper.
- 2 zippered, deep, slash pockets.
- Adjustable strap & buckle at throat.
- Type D-1, styled for easy, bind-free action.
- Soft, pliant, "aviation tan" leather.

Thousands of Satisfied Customers

Made to U. S. Gov't. specifications - "nuf sed!"
Sizes: #401, small; #402, medium; #403 large.
You've never seen them at these prices. Reconditioned, cleaned and brushed.
\$8.95 While They Last!



SLEEPING BAG
NEW! 100% wool. Mummy type. Heavy duty 30" zipper. Gov't. cost \$22.00 for used water repellent cover. **\$4.95 #303**



NEW TARPS - HEAVY CANVAS
Mildew & Flame Resistant. Cheap Outside Storage. They are Really Moving at These Prices.
5' x 7' **\$3.95** 9' x 14' **\$9.95**
8 1/2' x 10' **\$7.95** 14' x 21' **\$24.50**



NEW 100% ALL WOOL BLANKET
7 x 7 ft. Extra heavy. Also Double warmth. Fits Wood's Robe sleeping bag. **\$4.65** #414



Twas Made for the Air Forces! THE BEST Loose Leaf BINDER
You ever saw - 3 metal post. Cylindrical locking heavy duty 3/16" fabricated hinged cover. End identification window. Ideal for photo albums, students, publications, Reference books, artist sketch books, etc. Will hold 500 sheets, 8 1/2" x 11".
A \$5.00 Value for Only **59c ea.**
100 Page Binder Bond Fillers for 25c Extra.



HORSEHIDE WORK GLOVES
ALL LEATHER GAUNTLET TYPE REINFORCED PALMS & FINGER STITCHING.
LENGTH 13 3/4" #381 **\$1.95 pr.**
ALL LEATHER WRIST Length 10 1/4" #382 **\$1.55 pr.**
Barbed wire, welding, all purpose work gloves.
A Steal . . . Gov't. cost many, many times more.



#370 **SAFETY BELT**
New, in original box. Type B-14 Lap Safety Belt. Adjustable - full length 48", width 3". Forged steel, fool proof safety catch. Ideal for planes, jeeps, fun rides, farm equipment, etc. Try to beat this at **99c**



PALLEY SUPPLY CO. THE LARGEST FIRM OF ITS TYPE IN THE WORLD
DEPT. P. S. 127 - 6321 SAN FERNANDO RD. GLENDALE 1, CALIFORNIA



WHEN IT'S AN **Exide**... YOU START



No matter how soon you may expect to trade in your present car, if you need a new battery, buy one that will assure you dependable starting power. Remember—just one starting failure can cost you more than the little extra you pay for a trustworthy Exide Battery.

Buy starting assurance. Buy an Exide Battery. When it's an Exide—you START.

THE ELECTRIC STORAGE BATTERY COMPANY
Philadelphia 32

Exide Batteries of Canada, Limited, Toronto

DEPEND ON YOUR EXIDE DEALER FOR GOOD PRODUCTS, GOOD SERVICE

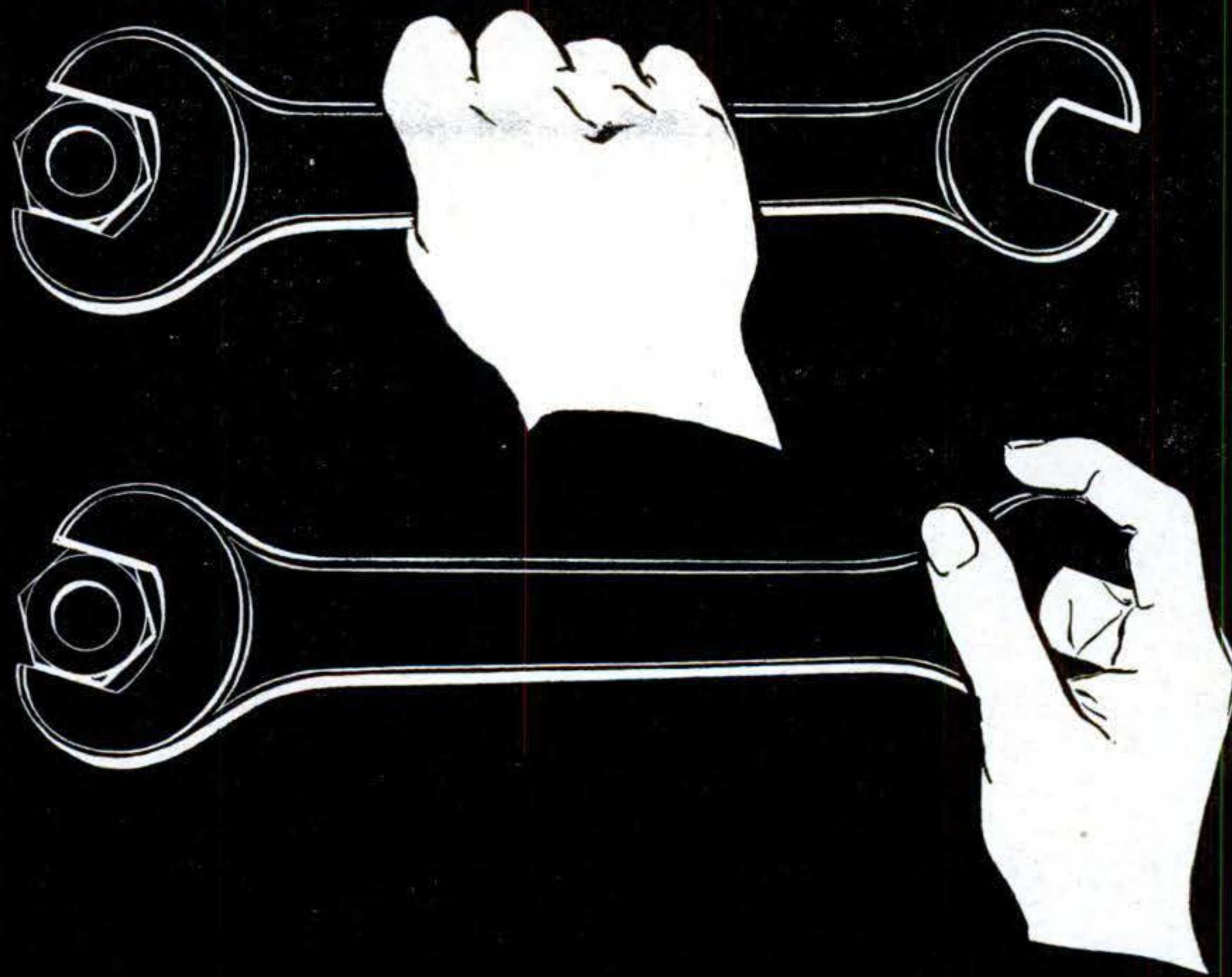

Science in Your Hand

SOME people, I notice, are afraid of the word "science." They seem to think it's too hard to understand; or it reminds them of the schooling they didn't like or didn't have.

This is as silly as not using a knife and fork because you don't know metallurgy. It's shut-eyed thinking because we live in the very midst of science. Every time you pick up a tool, you hold science in your hand.

Take the ordinary, open-end wrench pictured above. Used one many a time, haven't you? Probably the very first time you pulled down on a tough nut you found that the further out you hooked your hand, the less beef it took. Maybe you even figured out by trial that doubling the distance halved the effort. But did you have to get down a book and study up on, "lever, principles of," before reaching for the wrench? Certainly not!

There's really no need to fear science, or the mere names and fancy words which

package ideas in science. I can assure you there are plenty of scientists who wouldn't understand words many a mechanic uses without thinking. Words like *collet*, or *rabbit*, or *hob*, or *mandrel*.

In fact, you don't even have to understand science to be scientific. The most brilliant scientists work with many things they don't understand, especially in the almost unknown new world inside the atom. But they are scientific in their ignorance. They stand on what they know to reach for what they don't know.

So don't be afraid to touch the unfamiliar. The best tool in any good workman's kit is a brave mind that can look its own ignorance in the eye. And say, "So what?"

Perry Witheas



R. J. Reynolds Tobacco Co., Winston-Salem, N. C.

You're sure to please with
PRINCE ALBERT
 SMOKING TOBACCO

Look at this colorful, Christmas-wrapped pound tin of crimp cut Prince Albert Smoking Tobacco. It's all ready to say "Merry Christmas" to Dad, to Brother—to any man who enjoys choice tobacco—in his pipe—or in roll-your-own cigarettes. P. A. is rich tasting, mild, and easy on the tongue. Yes, you're *sure* to please with P.A.!

MORE PIPES SMOKE PRINCE ALBERT THAN ANY OTHER TOBACCO



THE NATIONAL JOY SMOKE

DECEMBER 1947

Popular Science
Monthly



Tomorrow's Power Plant?... This model of an atomic power plant is a blueprint of how we may put atomic energy to work. At left is the atomic pile where matter is changed into energy by splitting uranium or other fissionable material. Dr. Kenneth H. Kingdon, head of GE's atomic-power laboratory, is holding a rod of the "fuel" material. Striped rods below represent control rods, which act as throttles to regulate chain reaction. Fluid pumped through the pile would carry its heat to the heat exchanger at the right, where water—without being made dangerously radioactive—would be turned to steam, driving turbines and converting atomic heat into mechanical or electrical power.

DECEMBER 1947 81

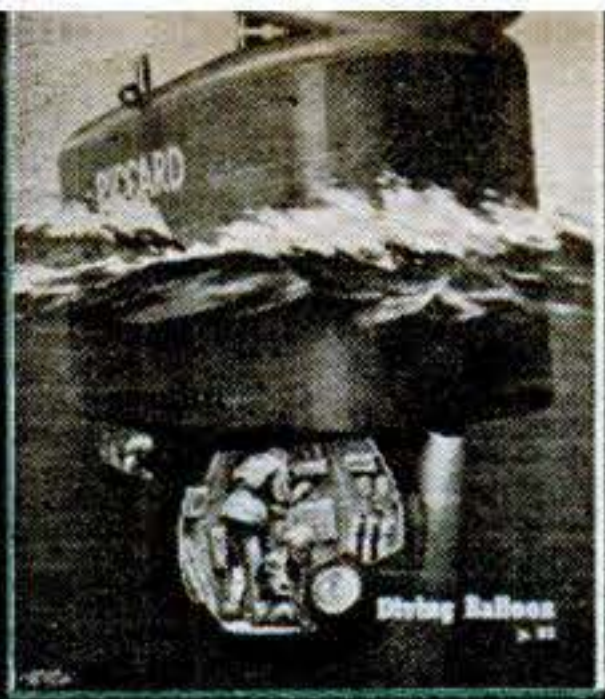

Piccard's Submarine Balloon

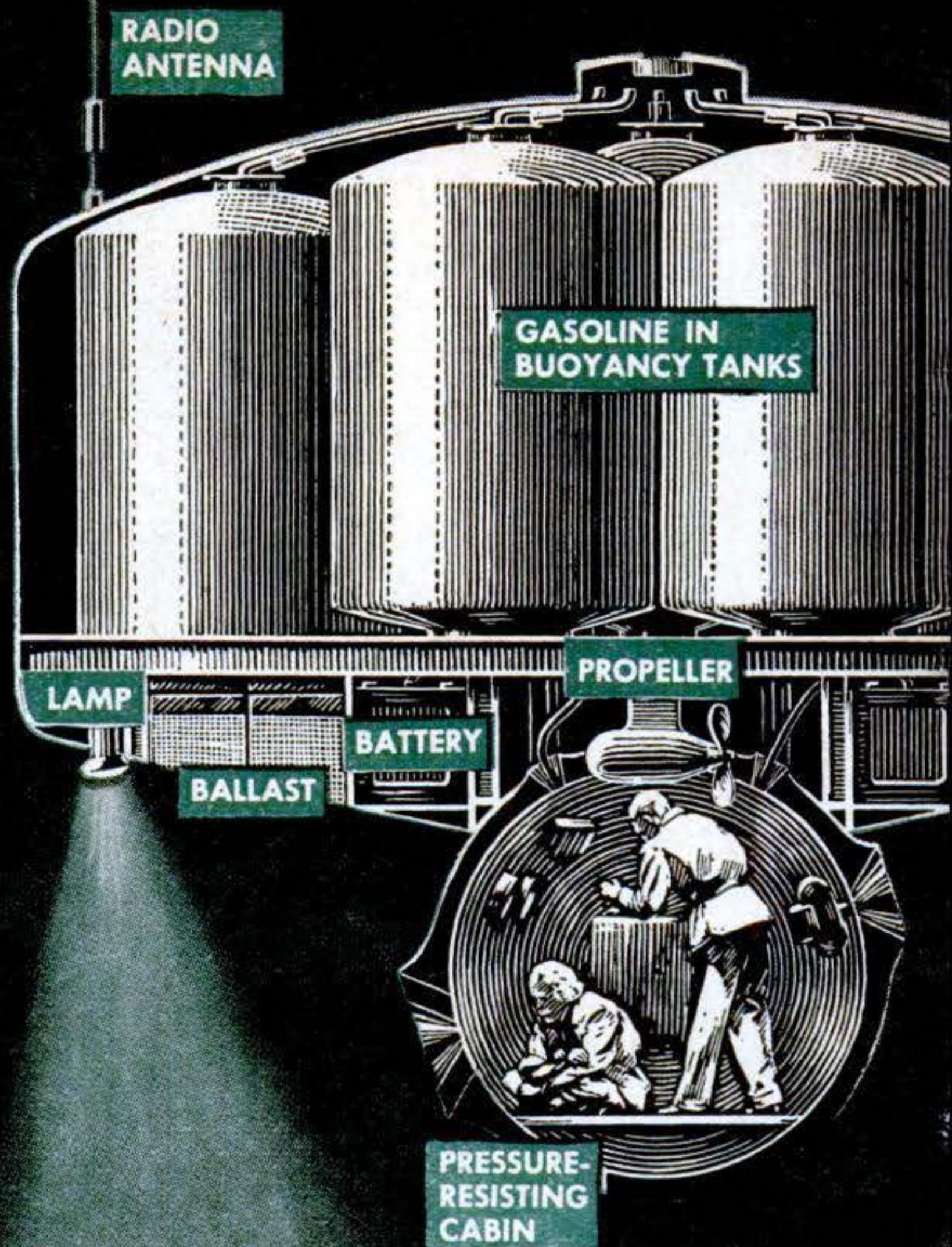

Professor Piccard's self-propelled "ship of the deep," with pressureproof cabin for pilot

A famous explorer of the stratosphere designs a remarkable undersea craft for a journey to ocean depths never before reached by man.

By Charles Wright,
Aneta News Agency Correspondent

BRUSSELS, Belgium—(Special to *Popular Science Monthly*). By applying the lifting principle of a balloon to a diving chamber, Prof. Auguste Piccard, pioneer explorer of the stratosphere, has found a way to descend to greater depths of the ocean than man has ever reached before. He has embodied his idea in a submarine craft of extraordinary design, able to navigate more than two miles beneath the waves. As this is written, he and his Belgian assistant, Prof.

Max Cosyns, of Brussels University, are preparing to entrust their lives to the invention in the Gulf of Guinea, off the Ivory Coast of Africa.

The existing deep-sea record was set in 1934 by Dr. William Beebe, of the New York Zoological Society, off Nonesuch Island, Bermuda. His spherical steel diving chamber, or bathysphere, was lowered to a depth of 3,028 feet by a steel cable.

Professor Piccard's subsea craft, in contrast, will not be suspended from its mother craft. Instead, it will navigate under its own power, driven by two propellers with elec-

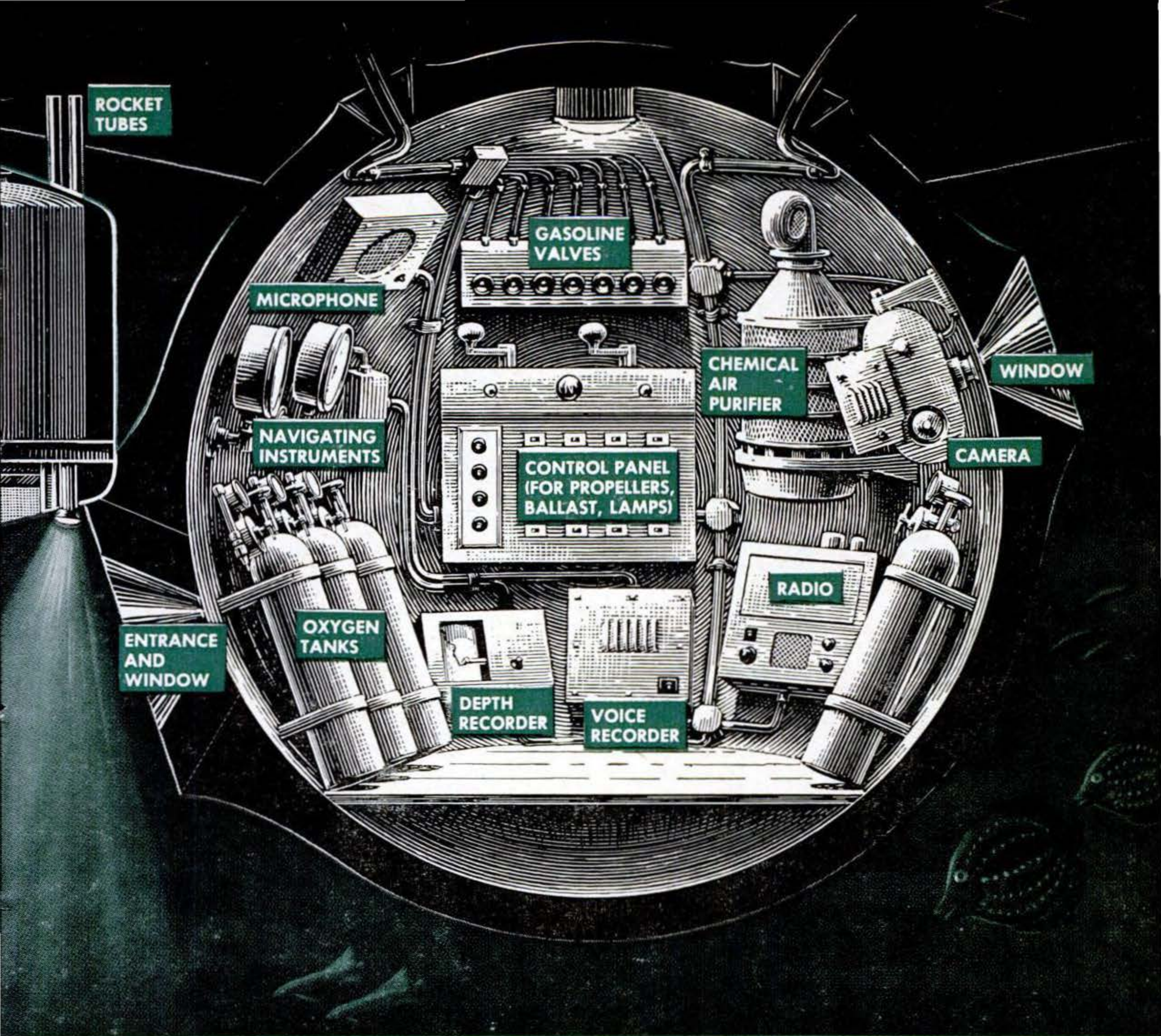

and observer, is shown at left attached to "balloon." At right is view of cabin's interior.

tric motors. The bushy-haired, 63-year-old, Swiss-born professor intends to take it down to a depth of two and a half miles, which is more than four times as far as Dr. Beebe went, to make scientific observations in an unexplored region of eternal night.

Armor Withstands Pressure

Combining the Greek words for depth and ship, Professor Piccard calls his craft a "bathyscaphe," or ship of the deep. Pilot and observer will ride in a hermetically sealed, alloy-steel sphere 6½ feet in outside diameter. Its massive walls, 3½ inches thick, will safely withstand the tremendous pressure of more than 5,700 pounds to the square inch—about a ton for every mile of

descent—resulting from the crushing weight of water overhead. Two windows of transparent plastic, measuring 16 inches in outside diameter, four inches in inside diameter, and six inches thick, give the crew a view into the lower depths. At the points where these ports are inserted, the walls of the sphere itself are correspondingly thickened for strength. The greater the water pressure upon the windows, the more tightly they are forced against their conical seats, preventing any leak. Electrical cables enter through smaller cones of plastic, similarly providing a watertight seal.

So that the men inside the globe can control its ascent and descent at will, Professor Piccard suspends it from a "balloon"—a



Professor Piccard (holding section from bathyscaphe model) and Dr. Cosyns examine results of test to tell how much pressure the cabin of their undersea craft can safely withstand.

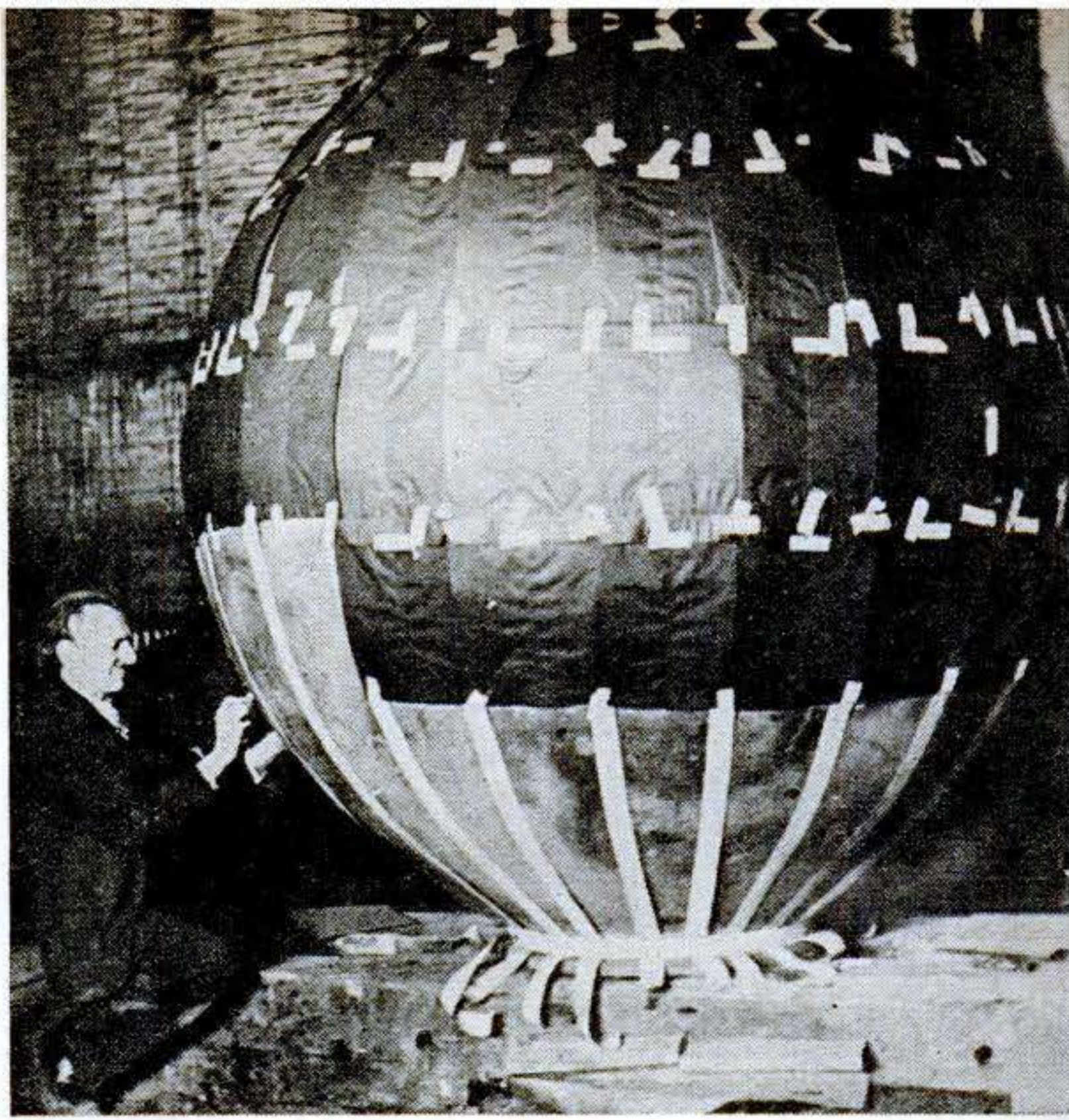

By placing radium within the cabin and attaching photographic films in envelopes to the outside as shown, radiographs were obtained to be sure that the steel contained no flaws.

buoyancy float consisting of seven aluminum cylinders within an encircling shell of thin metal. Just as the gas bag of a balloon contains a gas lighter than air, so these aluminum

air beyond all usefulness for displacing water. Even the gasoline, relatively incompressible, will be squeezed to a slightly smaller volume. Hence, openings at the bottoms of the cylinders will admit sea water freely, equalizing pressure inside and out and obviating any need for heavy armored walls such as the cabin requires.

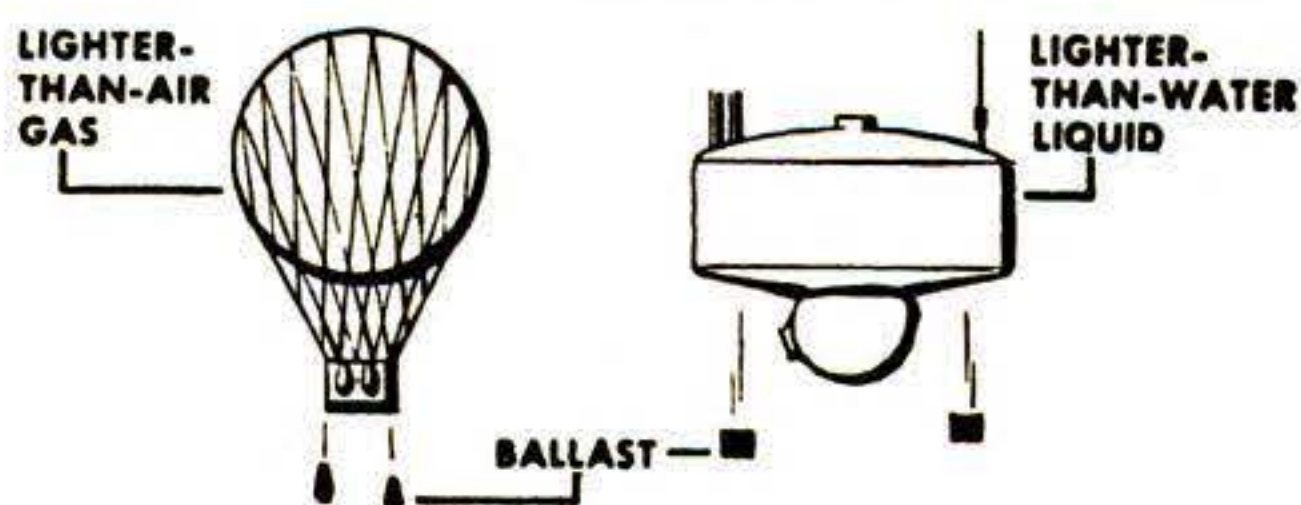

PRINCIPLE of balloon is used by bathyscaphe. It valves off fluid lighter than surrounding medium to descend, drops ballast to rise.

cylinders will hold a fluid lighter than water. For this purpose Professor Piccard has chosen aviation gasoline, which weighs 43¾ pounds to the cubic foot—just 20 pounds less than a cubic foot of sea water. Thus the total capacity of the cylinders, 1,000 cubic feet of gasoline, gives a lifting force of 20,000 pounds, or 10 tons. This will be considerably more than sufficient to counterbalance the weight of the steel sphere—its 10-ton weight out of water becomes 5½ tons when submerged—and its equipment.

The buoyancy tanks are filled with gasoline in preference to air because the extreme pressure to be encountered would compress

Upside-Down Ballooning

In order to descend, the undersea explorers will “valve off” gasoline, exactly as balloonists descend by valving off gas. To complete its parallel to a balloon in principle, the bathyscaphe will drop ballast in order to rise again. This ballast consists of heavy concrete blocks fitted with iron faces, so that they may be suspended from the float by electromagnets. As long as current flows through these magnets from a 2,600-pound storage battery built into the float, the blocks remain in place. By pressing buttons within the spherical cabin, the occupants may drop any or all of the blocks. For more delicate adjustments of buoyancy, iron shot may be dropped by other electromagnets. A total of 2½ tons of ballast may be released and, in an emergency, the storage battery itself may be jettisoned.

Equipment of the submarine gondola will provide every scientific facility for the adventurers’ purpose of observing marine life at extreme ocean depths and exploring the

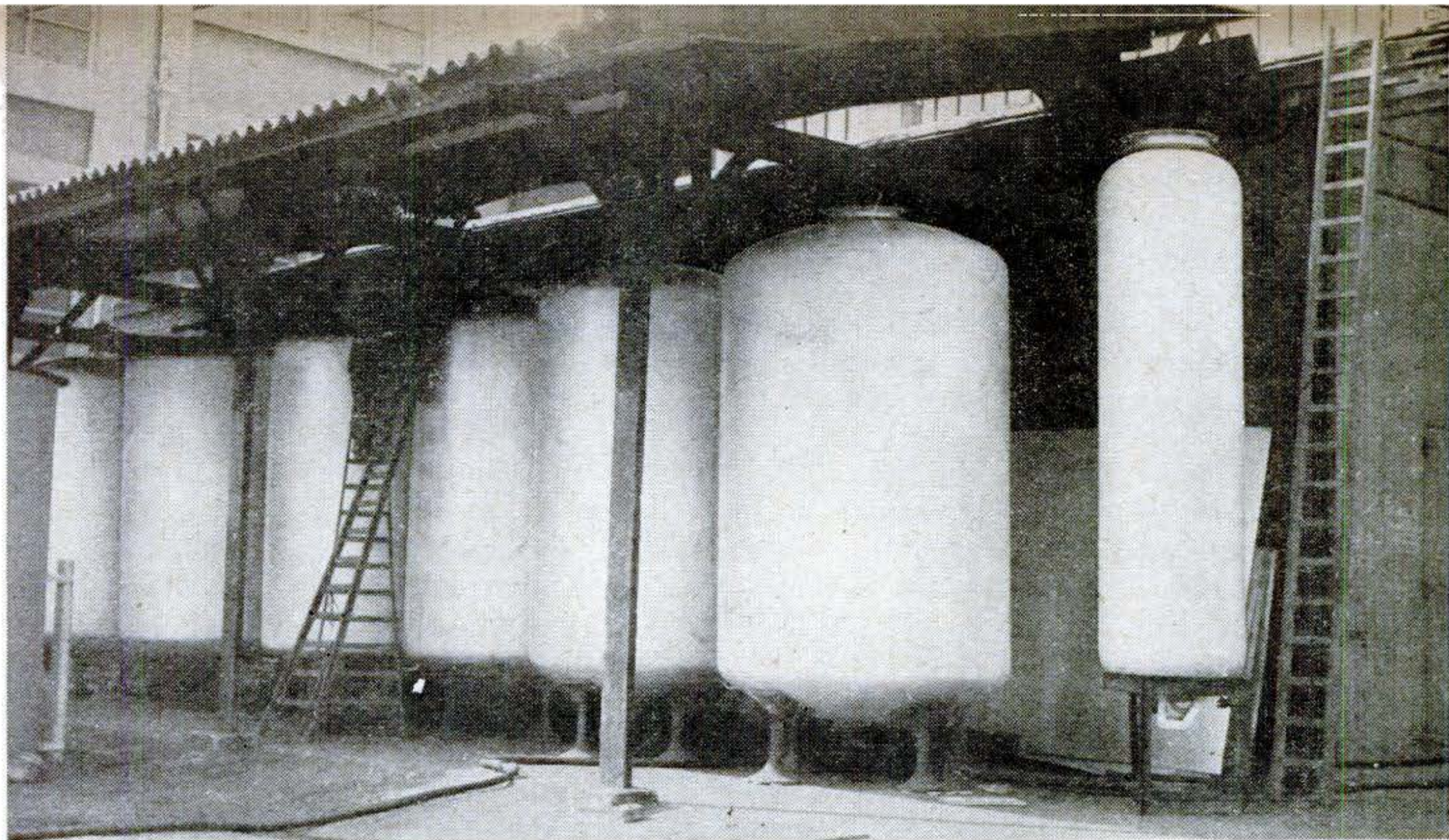

Buoyancy tanks, shown being readied for installation, will hold 1,000 cubic feet of aviation gasoline and give a total lifting force of 10 tons to counterbalance weight of bathyscaphe. Bot-

toms of tanks will be open to sea, equalizing pressure inside and out. This plan permits them to be made of lightweight aluminum, without need of special armored construction.

bed of the sea. Trained through a window, a motion-picture camera will photograph strange denizens of the deep illuminated by 3,000-candlepower undersea lamps. The films are expected to record a myriad of fish and other creatures new to science, which have eluded nets lowered from the surface in earlier attempts to bring them up for study. Because the explorers will be far too busy to jot down notes on their scientific observations, their rapid-fire comments on what they see will be picked up by the microphone of an automatic voice recorder,

A 4,000-ton ocean-going tug, the *Scaldis*, has been fitted out to serve as their floating base of operations. While the bathyscaphe rests on the deck, the two men will squeeze into the cabin through a circular entrance port, containing one of the windows, which will then be sealed into place. A crane will lower the apparatus into the water, the gasoline will be pumped into the buoyancy tanks, and the bathyscaphe will start its plunge.

Color of Sea Changes

Through the observers' portholes, as they descend, the color of the sea will change from bright green to blue-green, darker blue, and then to deepening gray as daylight fades out. As they approach the 2,000-foot level they will enter a wonderland that only the occupants of Beebe's bathysphere have penetrated before—a realm of absolute blackness such as surface dwellers can scarcely imagine, darker than the darkest night and punctuated only by the flashing blue and yellow lights of the weird, luminous creatures that inhabit this nether world. The walls of their steel sphere will become icy cold to their touch. At the depth they will reach, the sea's temperature hovers only a few degrees above the freezing point, summer and winter alike. As pressure gauges show the craft is approaching the sea bed, its distance above bottom will be

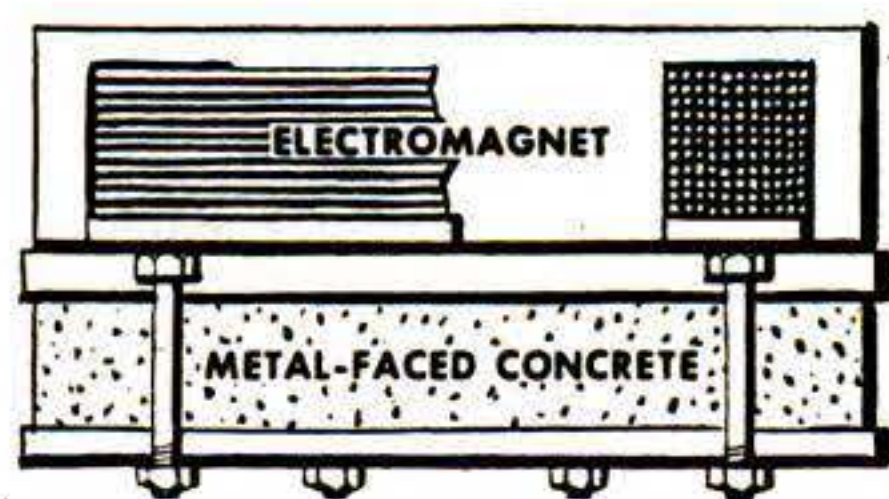

ELECTROMAGNETS enable ballast to be released by remote control from the cabin by pressing buttons cutting current to their coils.

to be played back and transcribed after they return to the surface. By remote control, they will operate equipment on the outside of the bathyscaphe that will trap specimens of deep-sea life, bring up bottlefuls of water, and collect samples of the ocean bed.

gauged by lowering a weighted cable from a motor-driven drum. By careful control of ballast and buoyancy, Professor Piccard expects to be able to keep the bathyscaphe within a few feet of the ocean floor as it drifts along, or turns on its battery-powered propellers for faster progress. For a better look at objects of interest illuminated by the powerful lamps, varying the relative speed of the propellers will rotate the cabin to face in any direction. Underwater navigation will be aided by a compass mounted on the outside of the cabin, with a connection to an indicator on the inside that will duplicate its reading.

Program for Record Dive

Plans call for an undersea journey lasting from eight to 10 hours, for which oxygen tanks in the cabin provide an ample supply, and an adequate reserve for good measure. Air-conditioning apparatus will keep the air in the sealed cabin purified by means of chemicals, removing exhaled carbon dioxide with soda lime and absorbing excess humidity with silica gel.

Just as a barograph serves to confirm an airplane or balloon altitude record, so a recording water-pressure gauge, whose pen similarly traces a record upon a revolving drum bearing a paper chart, will testify to the greatest depth reached by the bathyscaphe.

As the subsea craft ascends once more and approaches the surface, possibly several miles from its starting point, it will reveal its whereabouts to the surface ship by means of an undersea signaling transmitter loaned

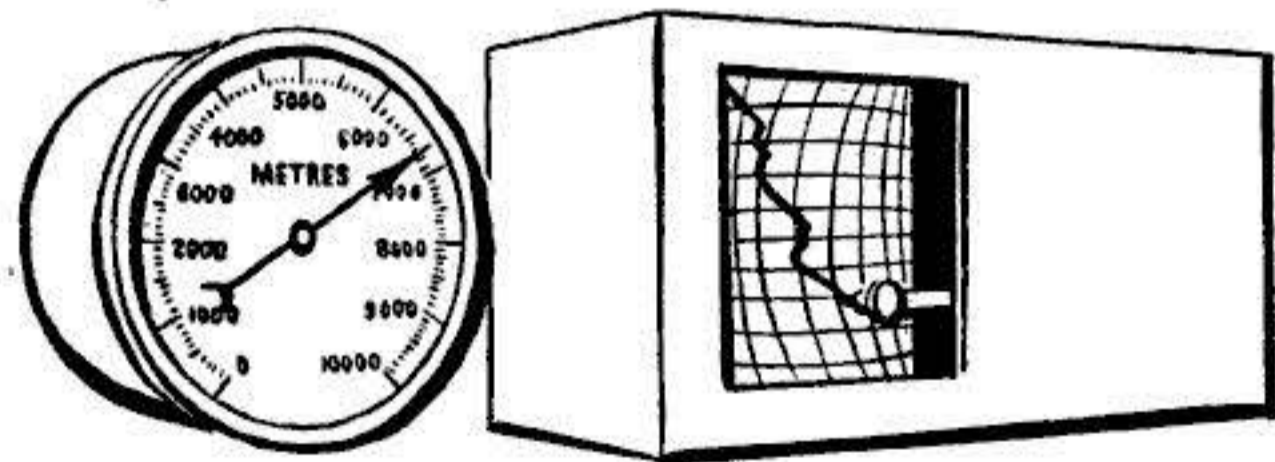

DEPTH gauges for plunge include dial type for pilot, and recording model that will verify level reached if new record is set.

for the purpose by the British Admiralty, a device of a type used during the last war for signaling between submarines with sound waves. Thus the *Scaldis* will be able to reach the bathyscaphe promptly after it surfaces, haul it aboard, and release the men sealed within it. In case of any slip-up, the bathyscaphe is also equipped to signal its surface

location by radio and by flares and rockets, and is brightly painted so that, if necessary, search planes should find it easily.

So far as human foresight can provide, every imaginable contingency has been anticipated. Models of the cabin, built to one-tenth scale and tested to destruction in a high-pressure hydraulic chamber, indicate the gondola will withstand two to three times the pressure it will encounter—a generous margin of safety. To insure against defects in its steel shell, a capsule of radium was placed within the ball and its entire

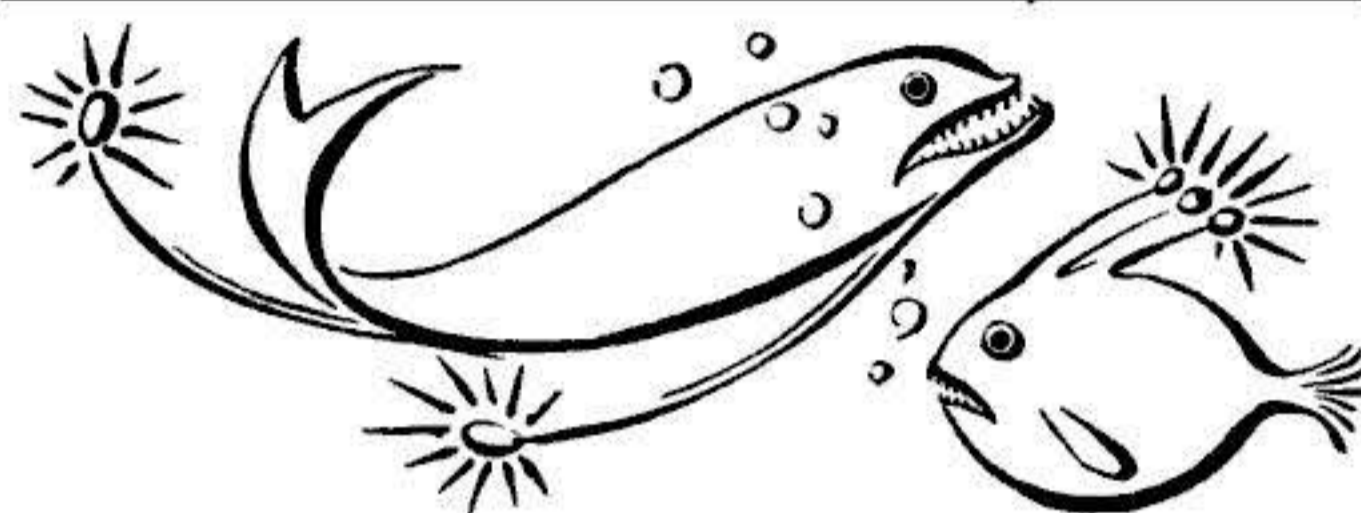

DEEP-SEA exploration by Beebe indicates that Piccard will find a world of darkness inhabited by strange luminous creatures.

exterior was covered with envelopes containing sheets of photographic film. The resulting radiographs revealed the metal to be flawless, save for one inconsequential "bubble" that was drilled out and filled with solid metal, just to be on the safe side. As a final precaution, the first descent with men aboard will be preceded by a full-dress test dive with the craft empty. Sent down to a depth of $3\frac{3}{4}$ miles, half again as deep as it is intended to carry passengers, it will be preset to release ballast automatically at this level and bob up again. If it survives the titanic crushing force at this depth, a total of more than 72,000 tons upon its spherical shell, it should serve its purpose successfully. Despite every possible precaution, however, the adventurers are well aware that their first descent will be a gamble with death. They are prepared to accept all of the hazards. END

Army Tries an Expendable Spoon

FOR use with combat rations, the Army has developed a plastic spoon that can be thrown away after one meal. Made of polystyrene, it is the Quartermaster Corps' answer to World War II complaints about metal spoons, which were hard to clean, sometimes rusty, and gave away military positions by rattling or reflecting sunlight.

DESCENT INTO THE UNKNOWN

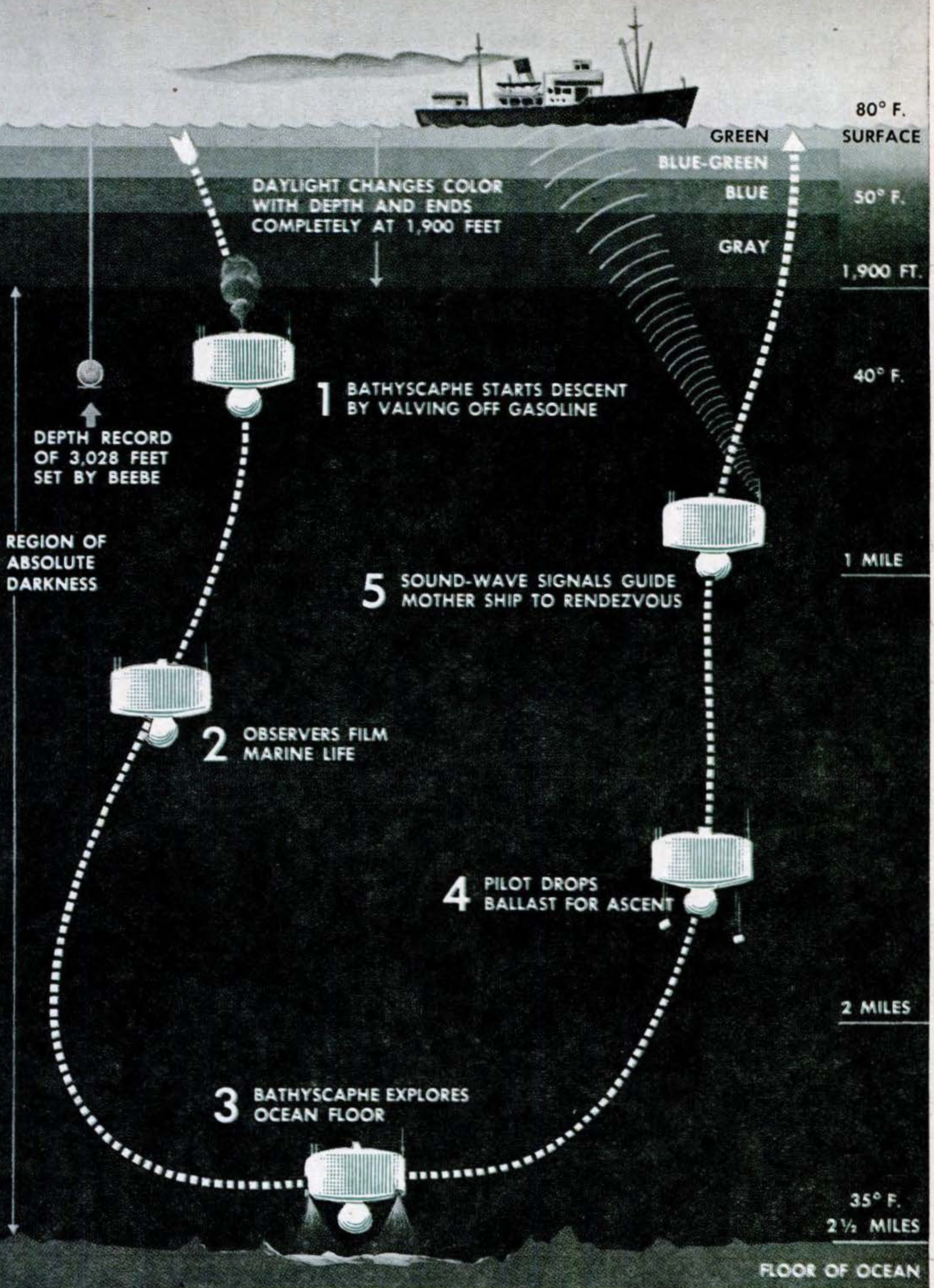

Plans for descent call for a perilous journey of eight to 10 hours to a depth where weight of sea overhead will exert titanic crushing force on the spherical two-man cabin. Drawing shows

how explorers will navigate the bathyscaphe and what they will encounter, as revealed by Beebe's pioneer dives in his captive bathysphere and by deep-sea soundings.

Silent Kick Starts 1948 Motorcycle

ENGINEERING refinements are featured in the 1948 motorcycles announced by Indian and Harley-Davidson. Starter noise, for instance, has been cut down in the Indian by means of a silent kick starter, in which the usual ratchet is replaced by a free-wheeling ball-lock device. Normally resting in holes in one plate, five metal balls engage in sockets on the gear face when the starter is used. A click—and your motor's running.

The Harley has new tricks, too—aluminum heads, a feature that reduces engine weight eight pounds, and hydraulic valve lifters of the push-rod type for 61-cu.-in. and 74-cu.-in. overhead valve engines. Previously used only in airplanes and high-priced cars, these lifters are self-compensating for expansion, contraction, and wear of the valve train. The rocker arms operate in an oil mist that helps cool the aluminum heads. Top frame members are higher to allow for the rocker covers.

Other new Indian features are a lock to keep the kick-stand leg from folding up if the cycle is pushed, and a five-gear oil pump that replaces the plunger type. The speedometer is operated from the front wheel.

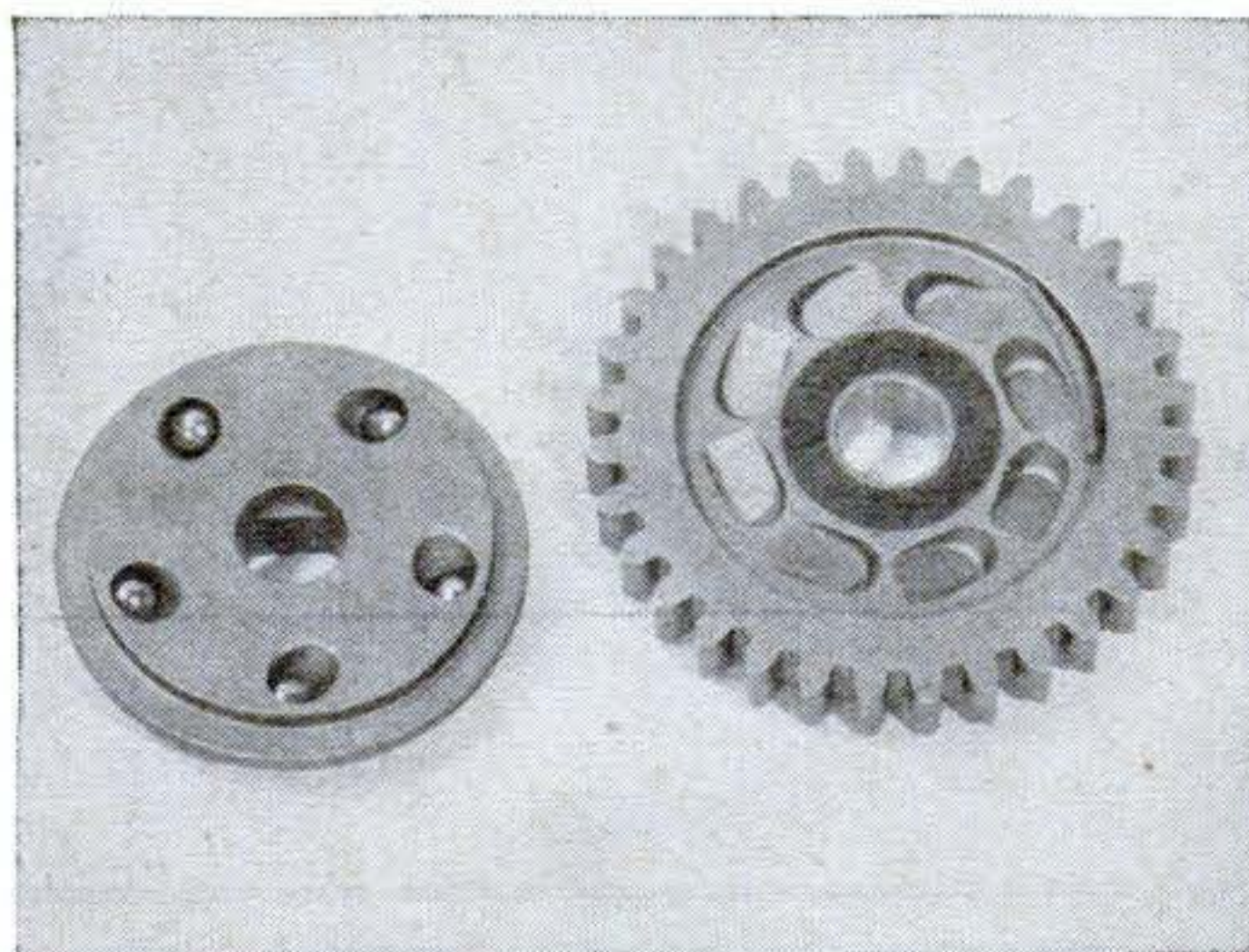
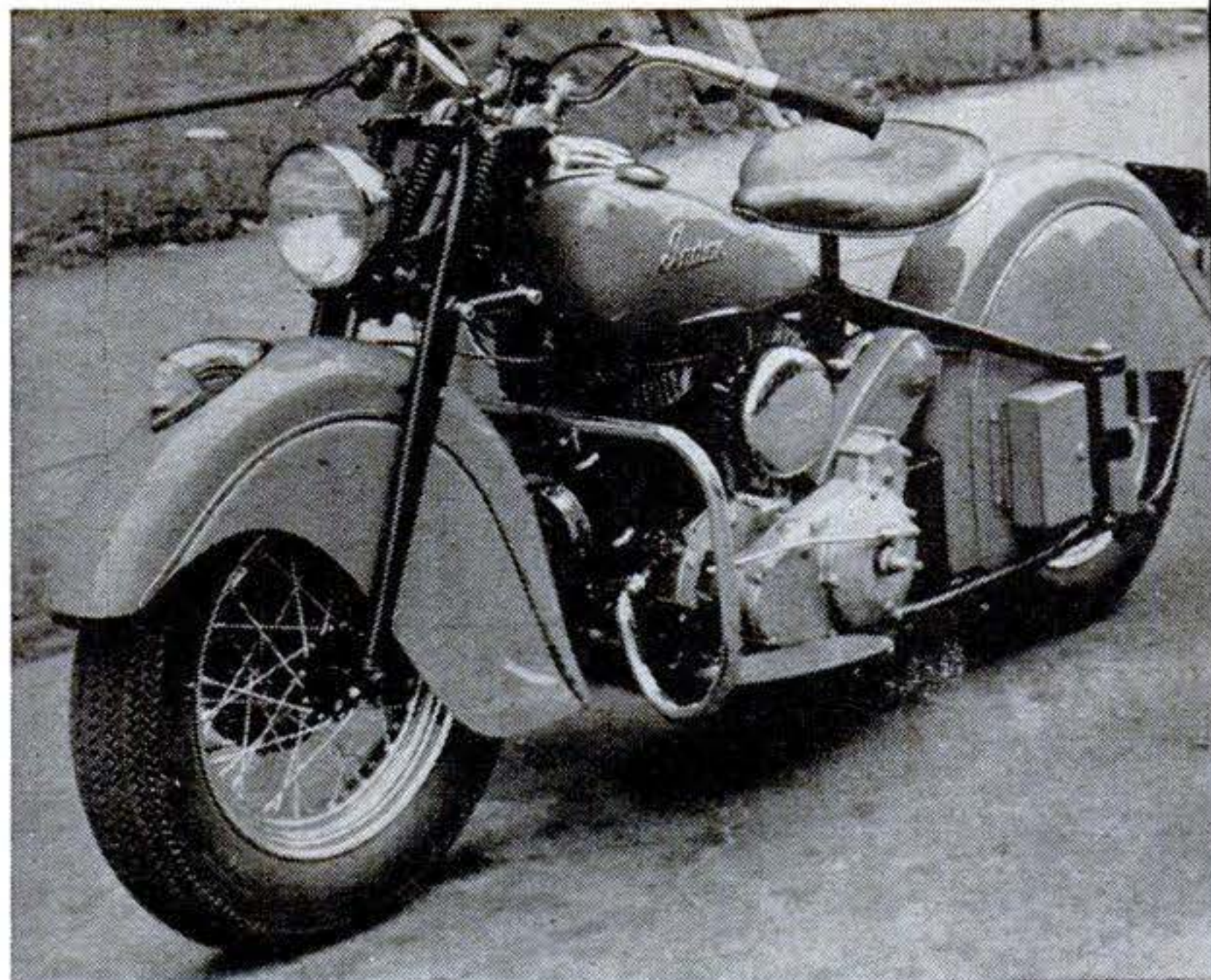

Starters in the 1948 Indians are operated by this two-part ball-lock device. In use, the five metal balls engage in the recesses seen on the gear face. At top is the 1948 Clubman.

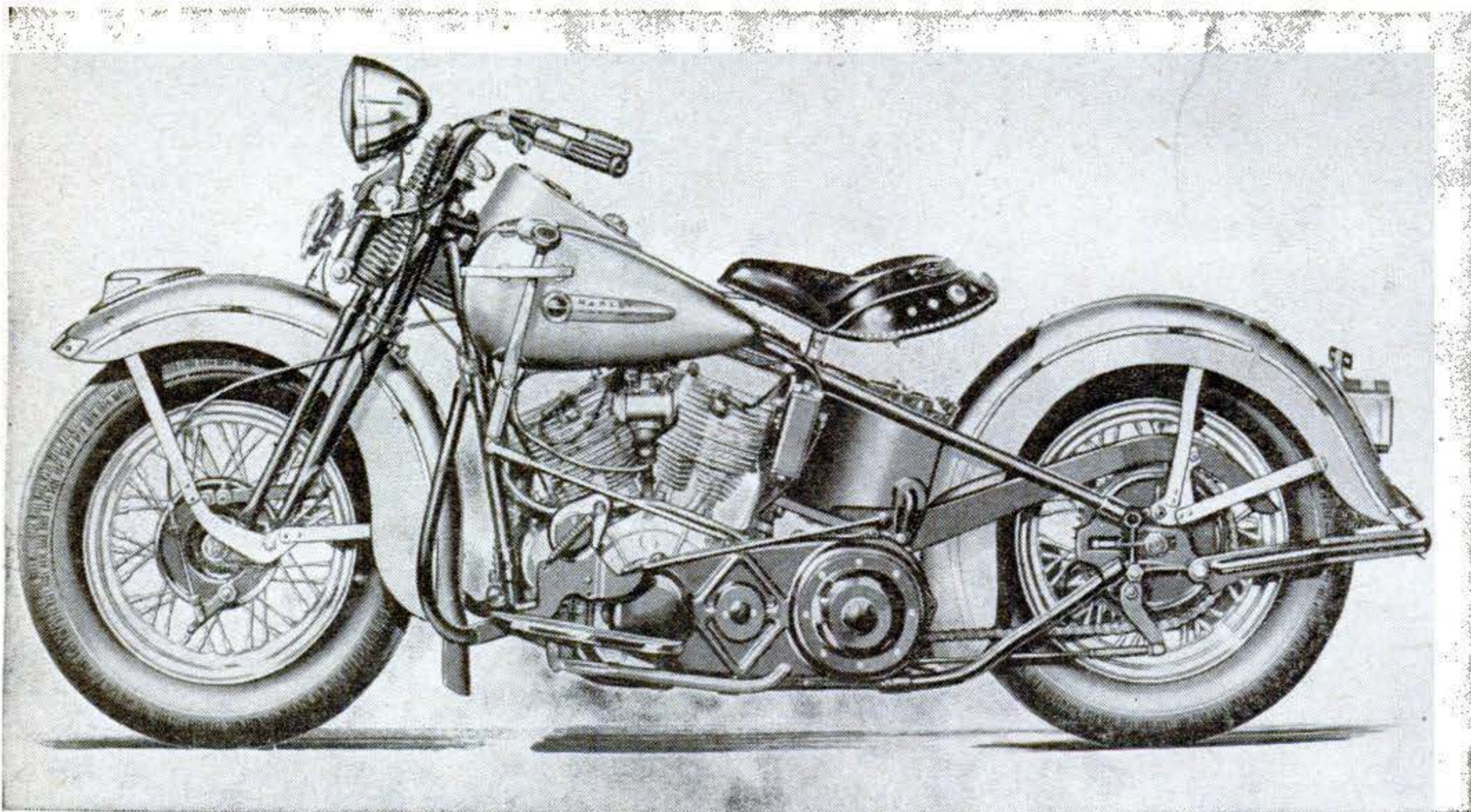

Felt-lined covers reduce rocker-arm noise on Harley OHV models. This is the 74 OHV twin.



Flying Wing Weds Jets

THE flying wing and the jet engine have been married to produce the mightiest bomber of them all—the Northrop YB-49—shown here taking off with a roar of smoke on its first test flight.

Its eight, giant J-35 turbojets develop

32,000 hp., almost three times the power of its propeller-driven counterpart, the B-35 Flying Wing. Bomb bays, cargo space, crew quarters for 13 men—including bunks for six off-duty members—are all in the seven-foot-thick wings. Designed for the Air Force as a very heavy bomber, the tailless plane can be adapted to cargo or transport use.

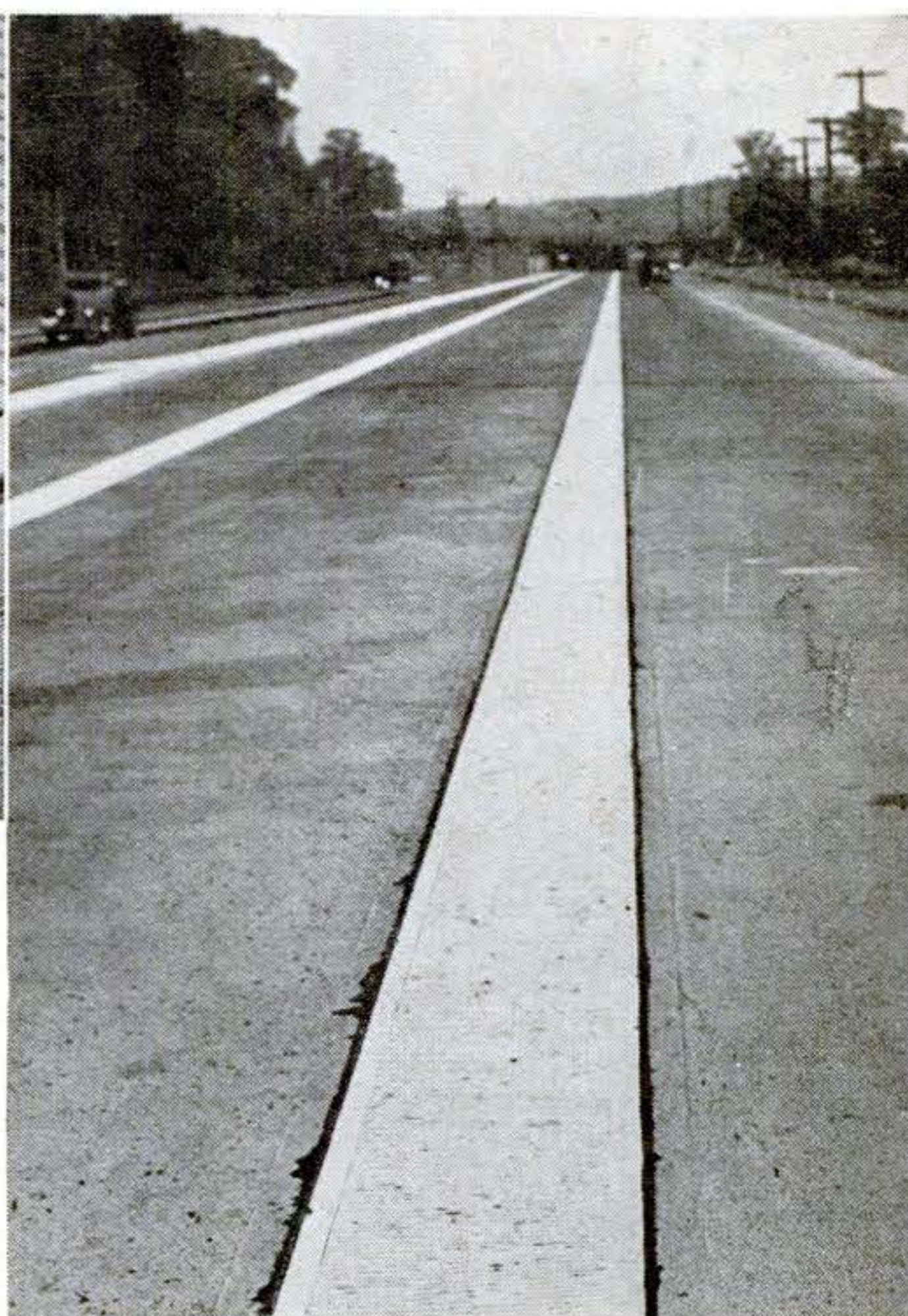

This Road Talks Back

IF YOU cut over that sacred white line on a New Jersey highway, don't be surprised if the road tells you off. The "voice" is a corrugated strip of white cement, 24 inches wide, that hums loudly when tires roll over its hills and valleys (at left, above). Two of these strips, placed on either side of the center lane in a three-lane highway (at right), warn the motorist that he is entering a danger zone. The device is installed on a section of Route 6 near Paterson, N. J.

The talking strips not only warn the careless, but are especially helpful at night or in fog when the line is obscured. De-

signed by Harold W. Giffin, an engineer for the N. J. Highway Commission, the strips originally were planned to reflect headlights. Now engineers are wondering if they can't work out a design so that the road shouts "Get over! GET OVER! GET OVER!"



Locomotive Laundry Scrubs Four an Hour

Getting a shower-plus-scrub at two miles an hour, this dirty engine will soon be shining.

SCRUBBING the grime of travel off a giant electric locomotive by hand takes three hours. But a monster mechanical washing machine in the Pennsylvania Railroad's yards at Long Island City, N. Y.,

now gives engines a top-to-toe bath and puts them back on the road in 15 minutes. Three hundred feet long, the laundry is semiautomatic, needs a crew of only four men. Here, in pictures, is how it works.



1. The "pig," a winch-drawn pusher, hides under tracks until engine passes, then emerges behind it to shove it through laundry. Engine's 11,000-volt power has to be cut off during bath.

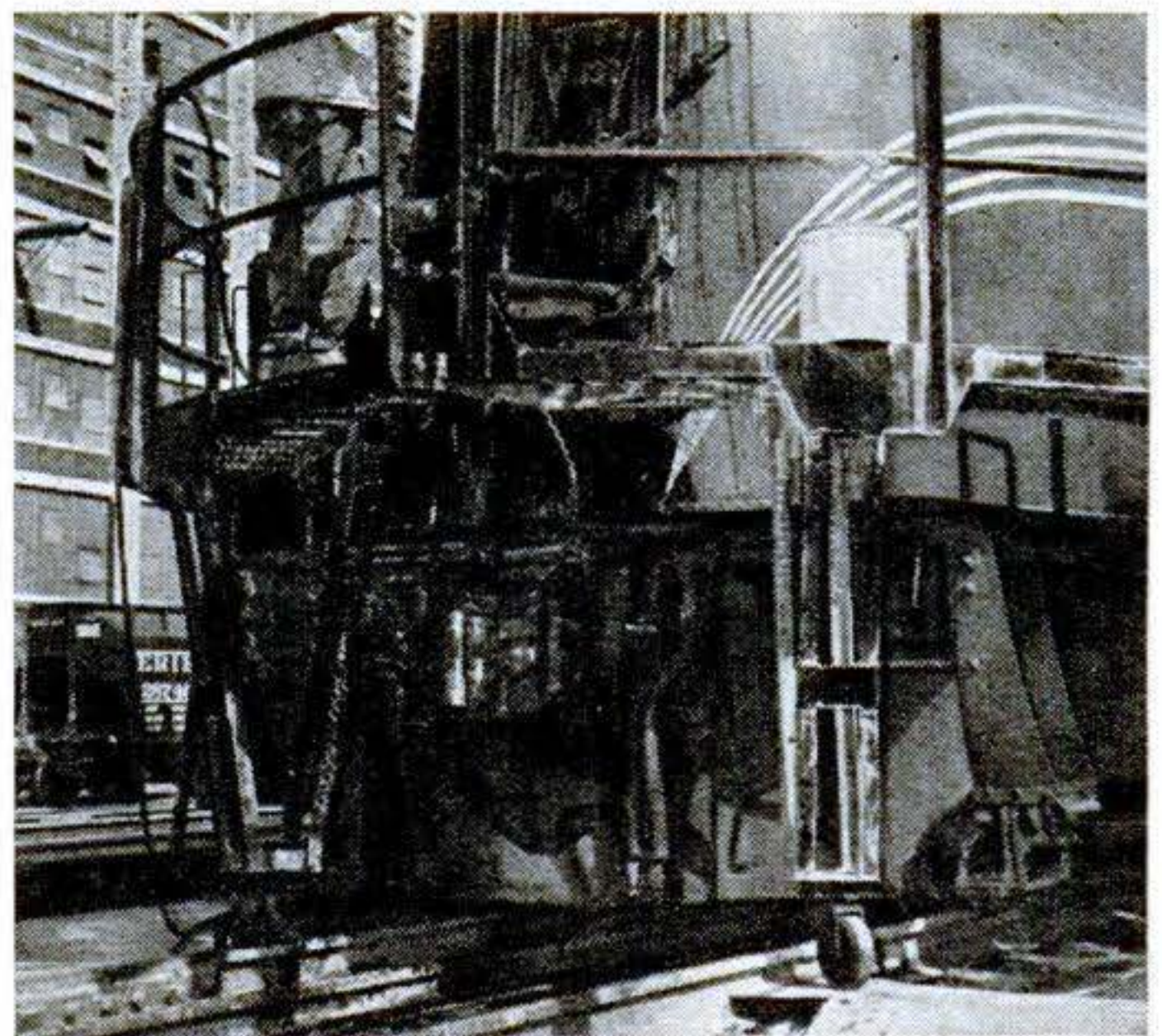

2. Curved platforms swing across track behind and ahead of engine so that two men can climb up to scrub its ends—the only manual part of the process. Here rear end is being groomed.

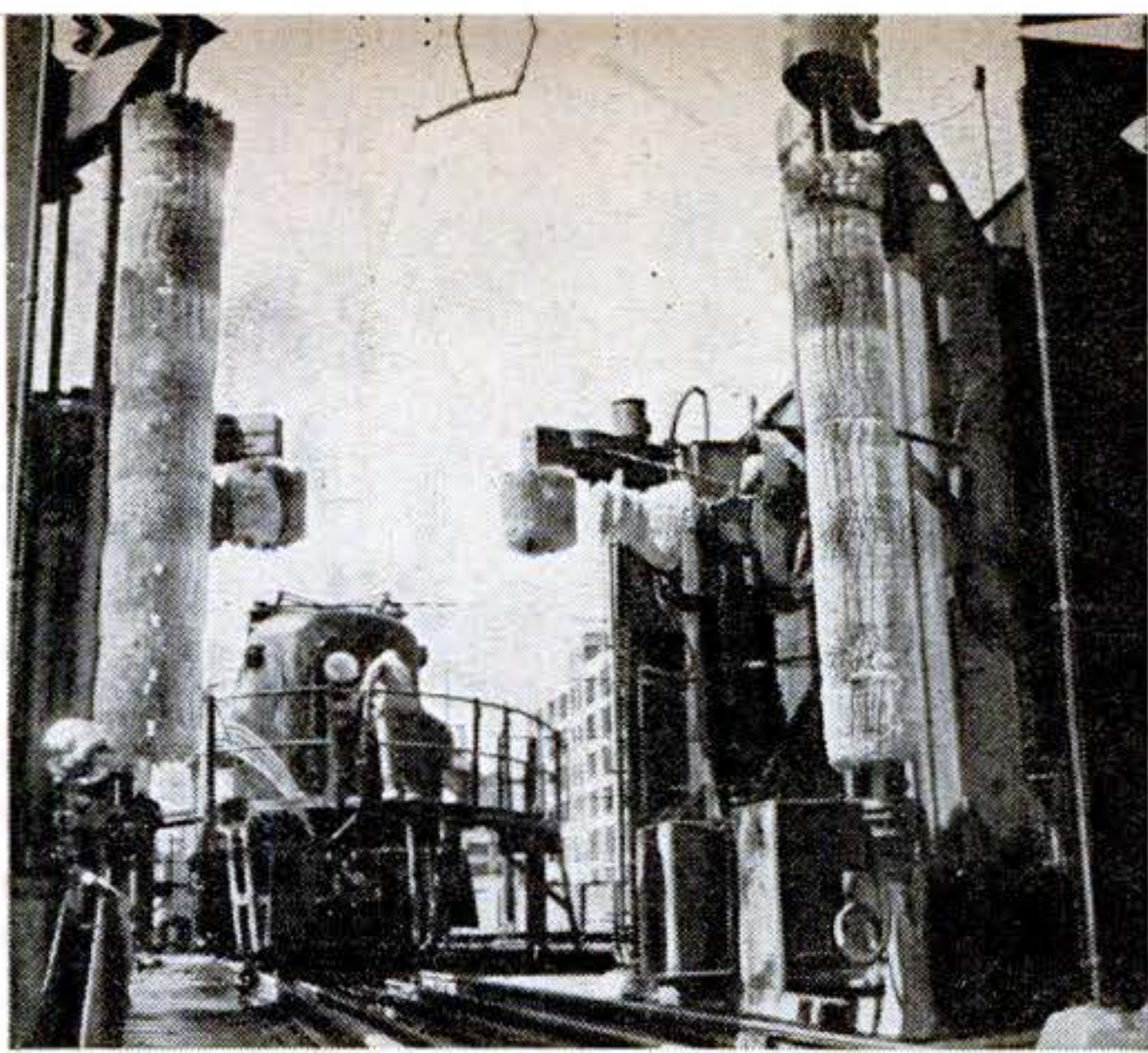

3. Front end gets the same treatment while the first set of rotary brushes, three on a side, wait in foreground to begin the real scrubbing. Engine reaches this point under its own power.

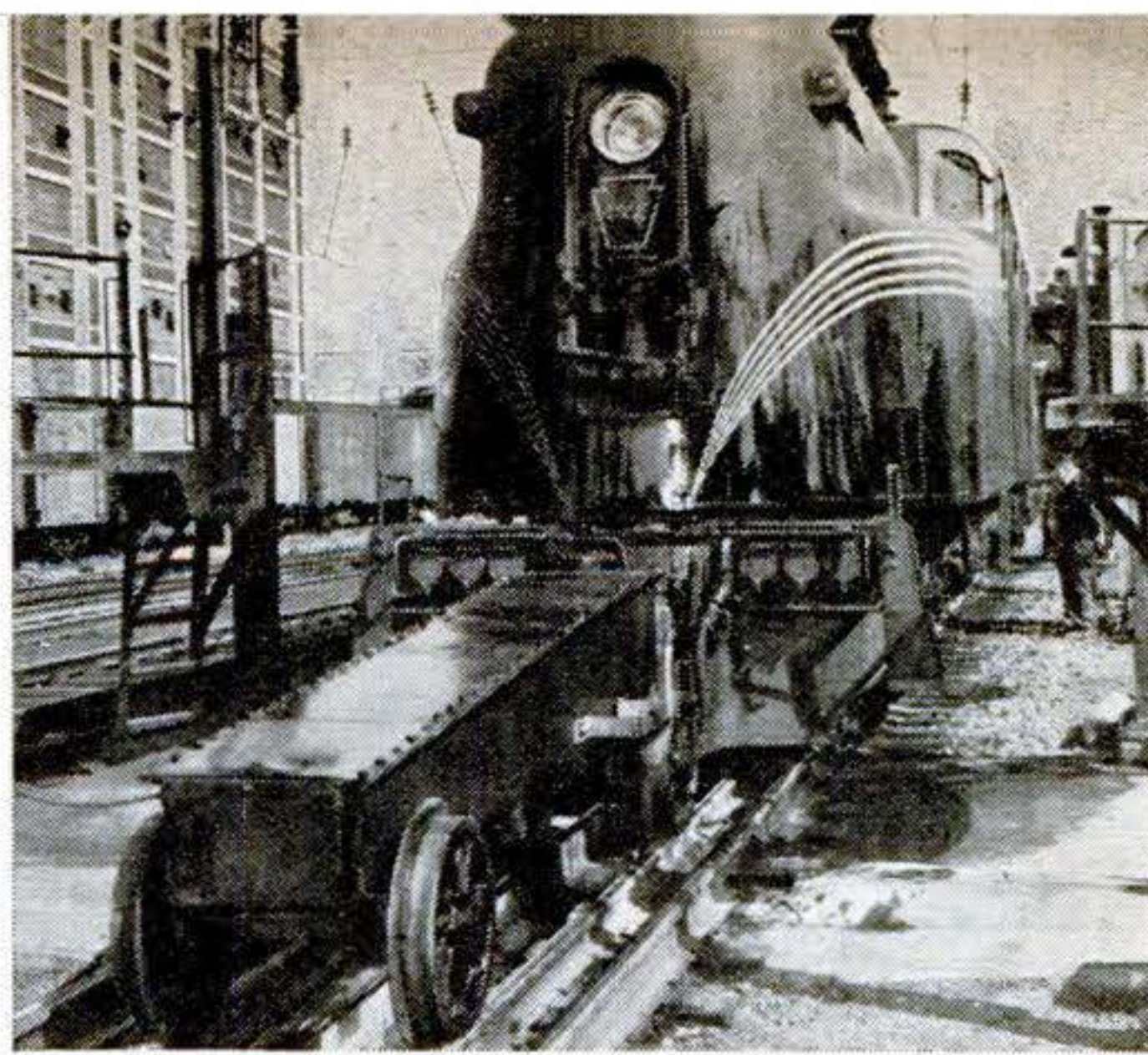

4. After end platforms are swung clear, the pig starts pushing along its narrow-gauge tracks between the rails. As locomotive reaches brushes it is showered with oxalic-acid solution.

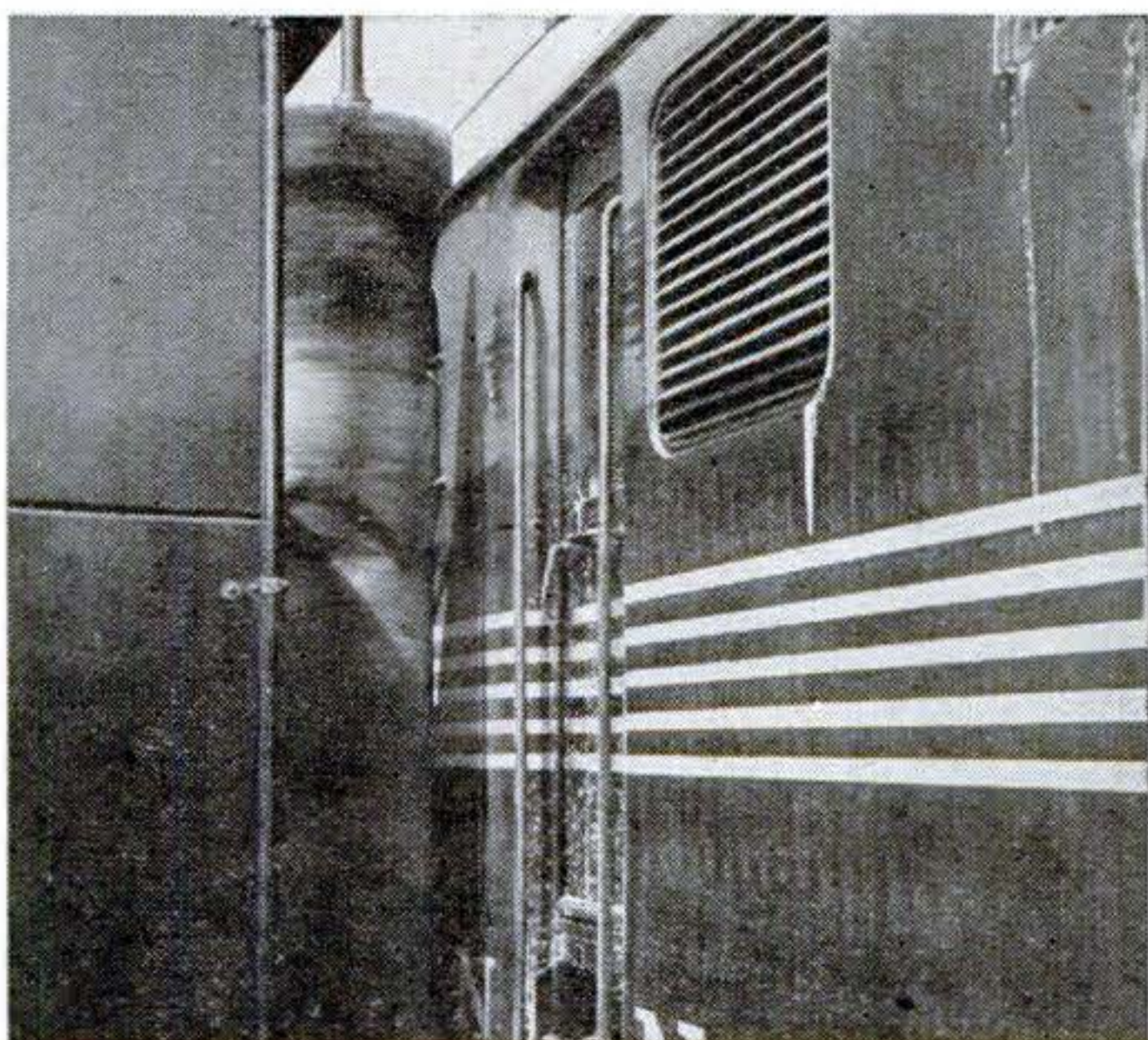

5. Whirling brushes, pneumatically controlled, snuggle their long straw bristles against the engine to follow its contours. Here engine's door moves past a tall side brush.



6. On top, two brushes to a side share vertical and horizontal surfaces. There are two complete brush installations; first set cleans, second set polishes while engine is rinsed.

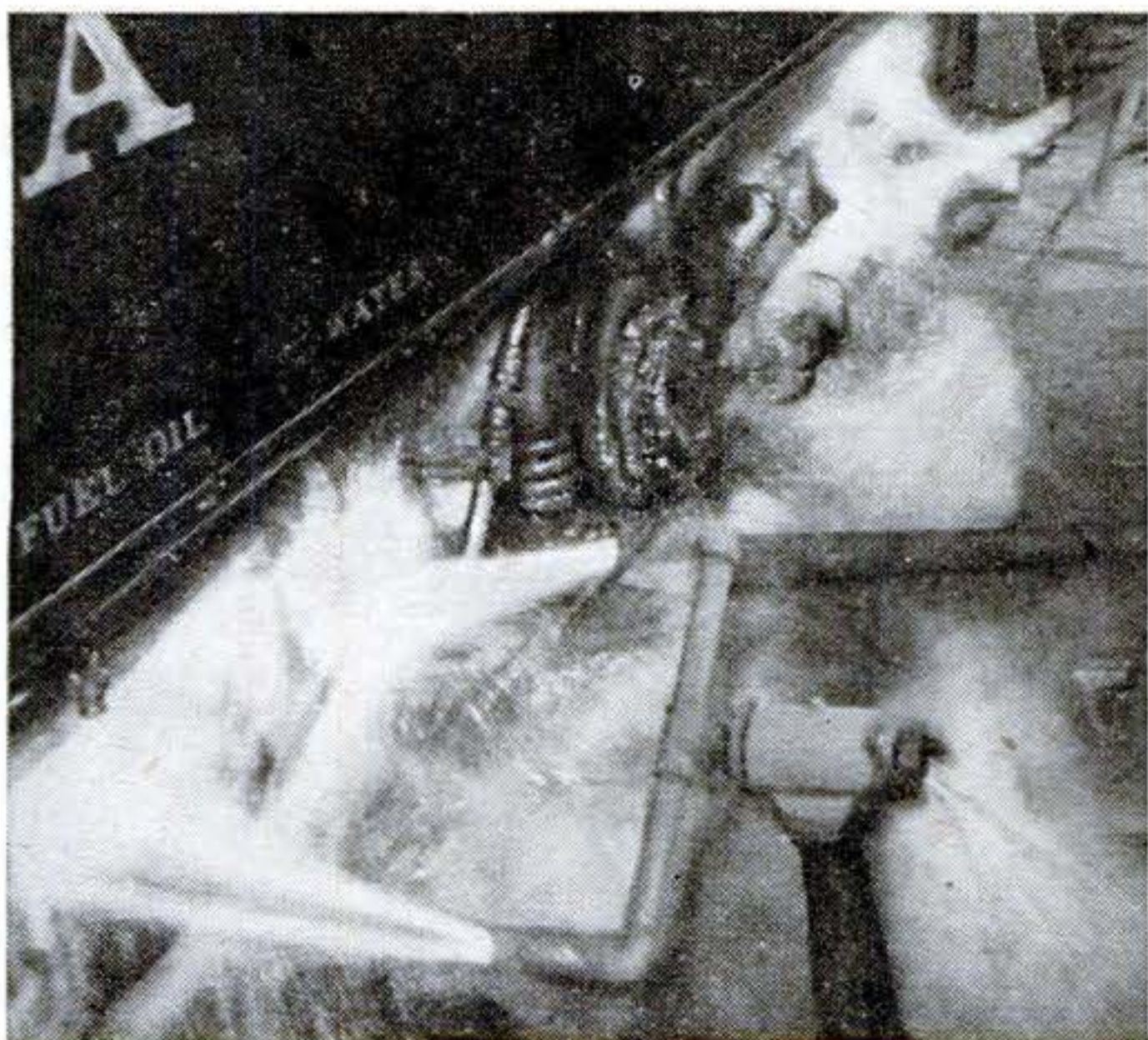

7. Rotary washers spin like pinwheels to blast steam and hot water against running gear as engine passes laundry's midpoint. Treadle on track turns washers and showers off and on.

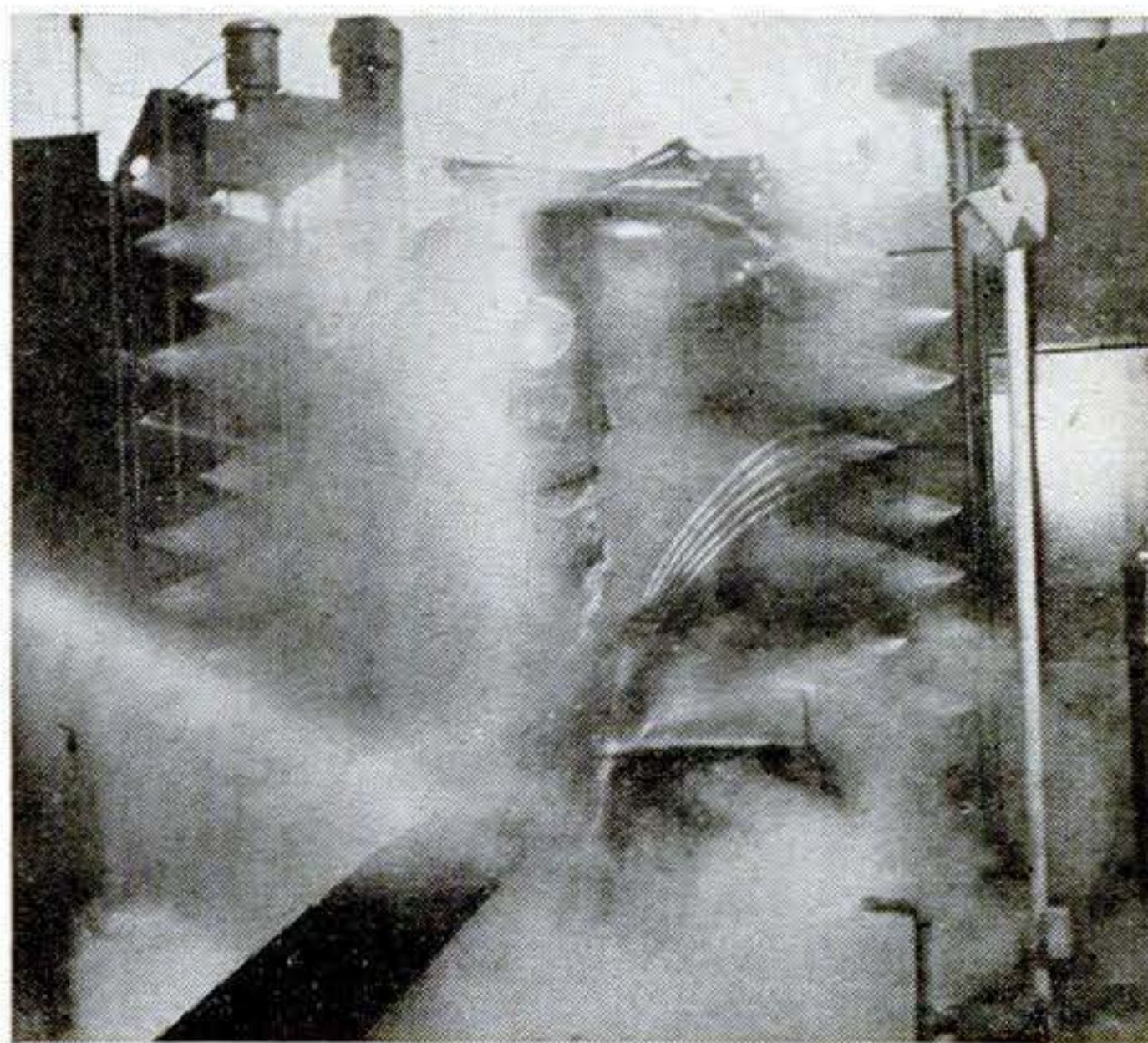

8. Passing second set of brushes, engine is rinsed, then coasts away to pick up power line. The pig—"cleanest pig in the world," its operators say—goes back for another engine.

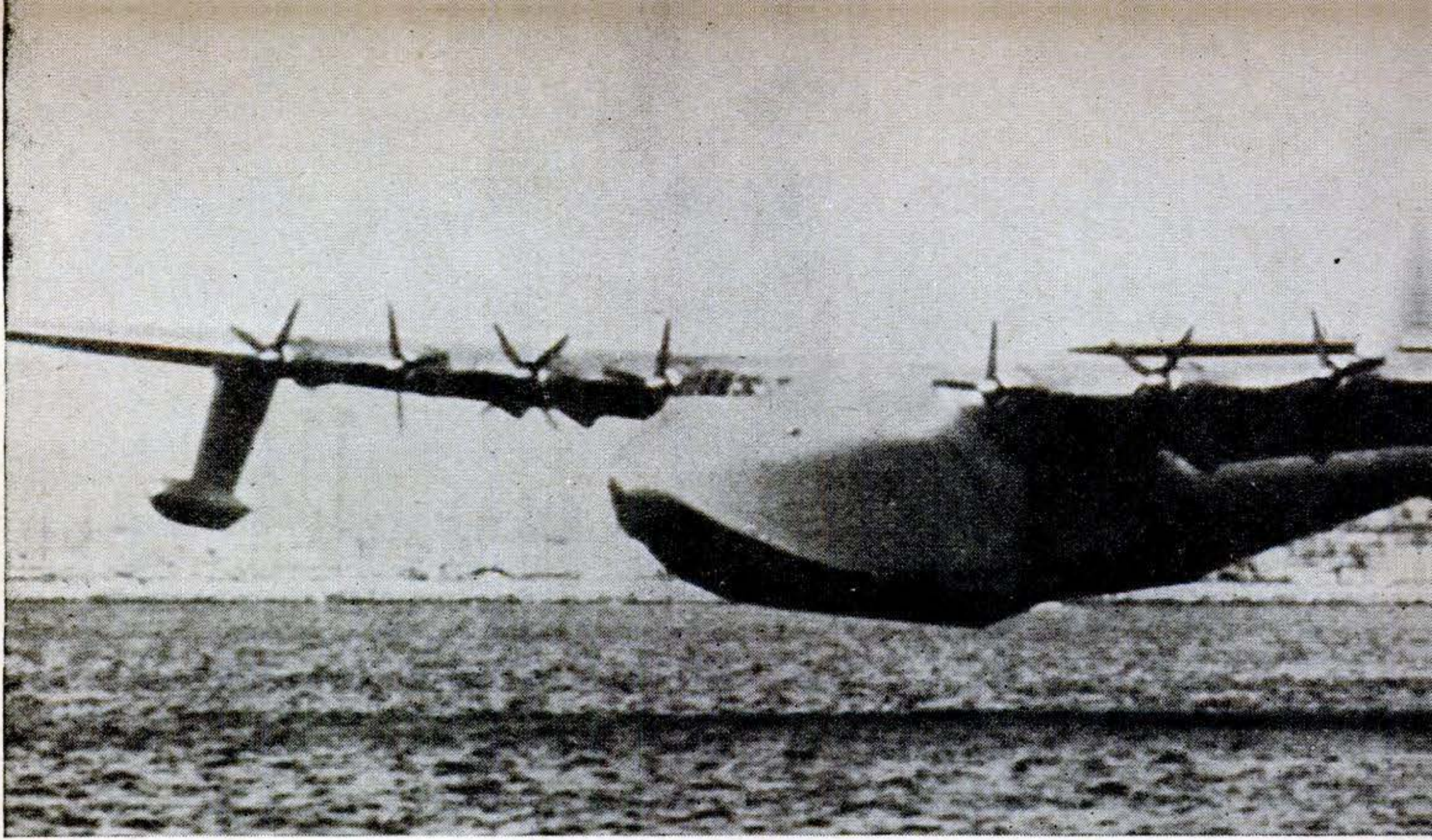

World's Biggest Plane Makes



View forward on flight deck of 400,000-lb. flying boat shows upper level of nose. In back-

ground Hughes discusses plans for taxi test with flight engineer and radio operator.

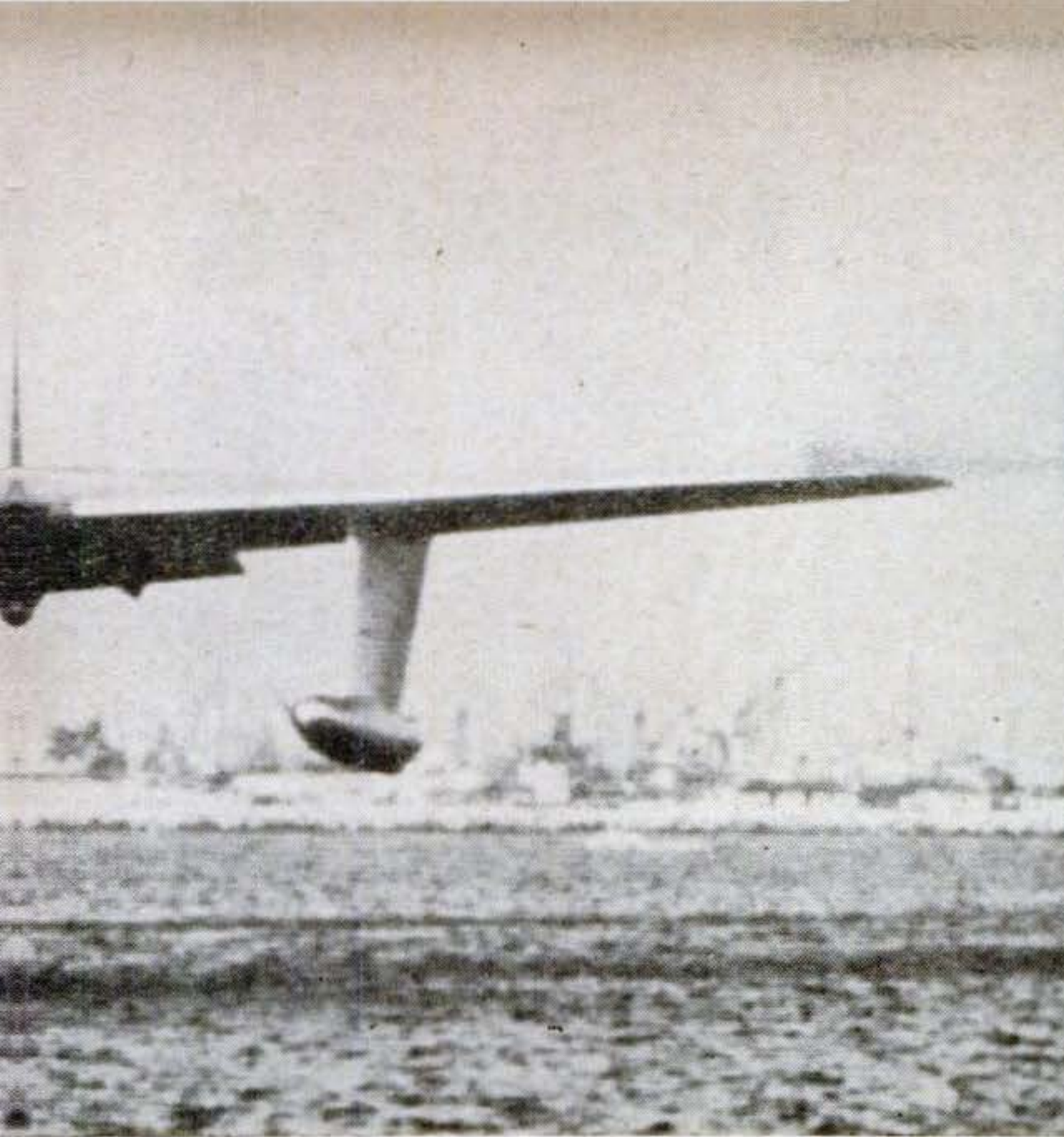

First Flight

The biggest airplane in the world, Howard Hughes' huge flying boat, has taken to the air at last. Hughes himself, shown above at the controls, unexpectedly lifted the big ship between 70 and 80 feet in the air during a taxi test in Los Angeles harbor.

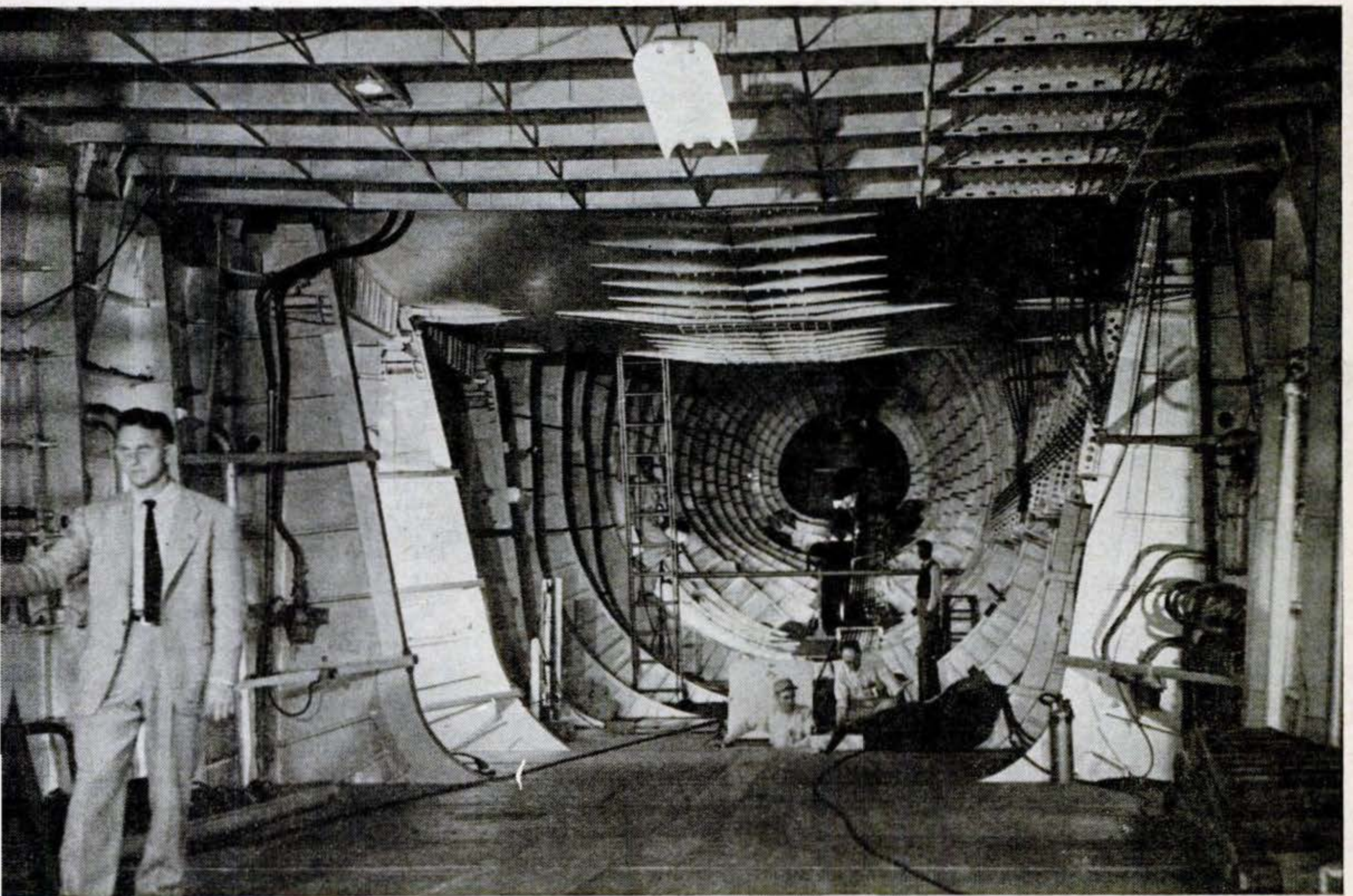

Workmen dwarfed by huge center section of \$25,000,000 plane give idea of vast size. Its wing span is 320 feet; length, 219 feet. Plane hit 100 m.p.h. during first test.

What's New in Aviation

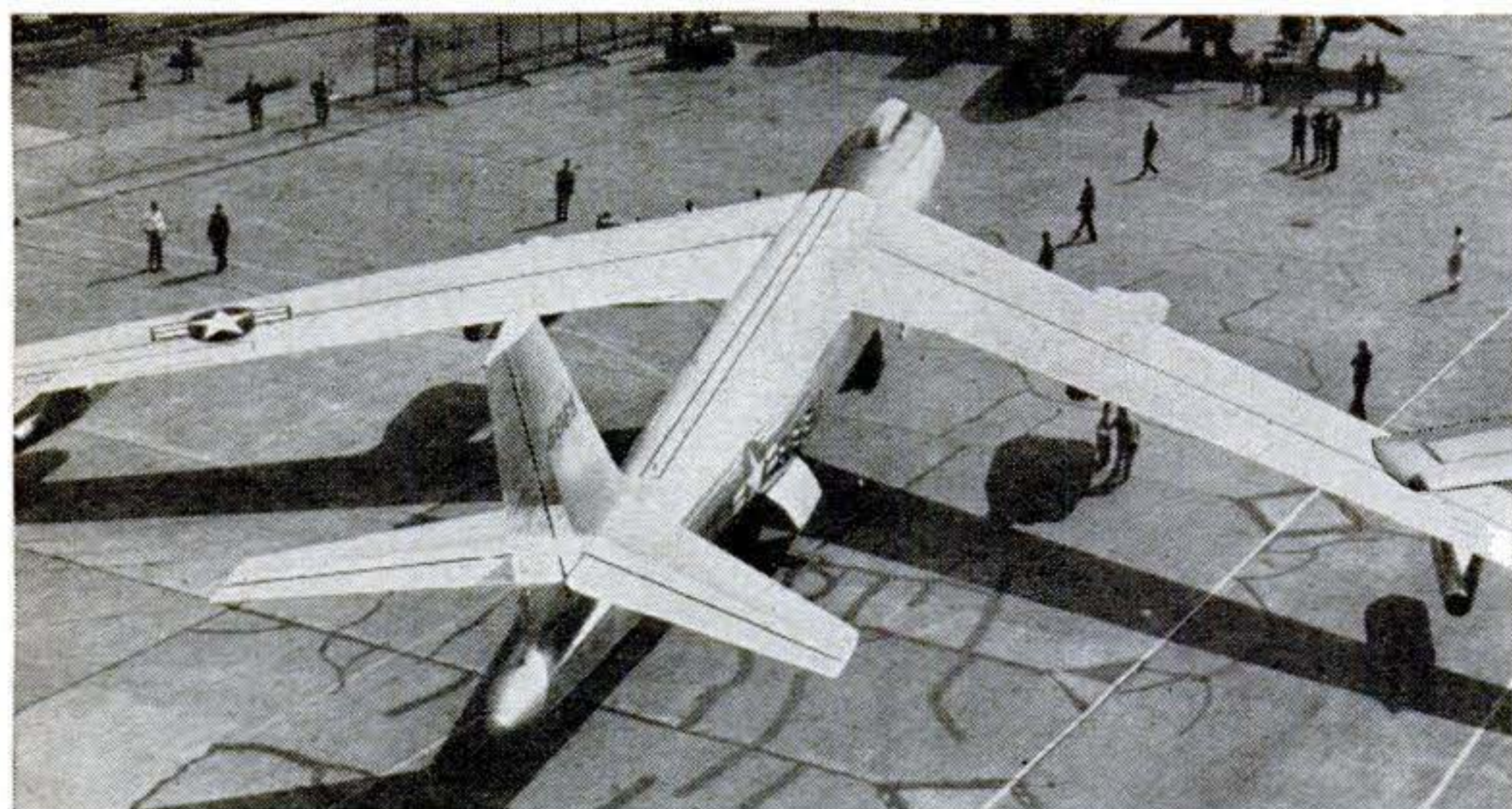

Built for Speed. Sharply swept-back wings and tail surfaces make Boeing's six-jet XB-47 really look like a postwar bomber. Double nacelles inboard and single ones near

the wing tips provide a novel underslung mounting for the General Electric jet engines, keeping the leading edge of the wings virtually unbroken. Like the Martin XB-48,

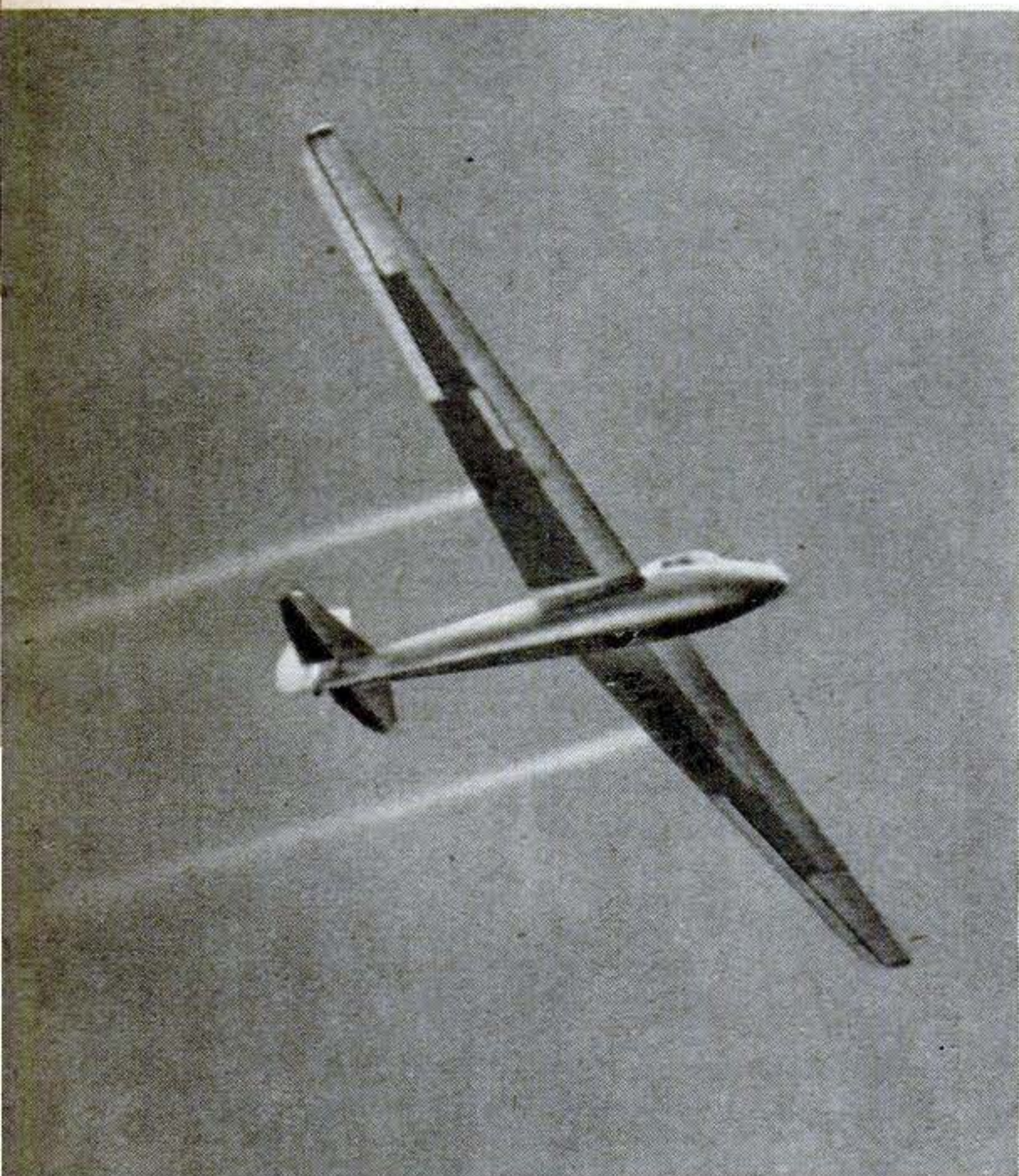

That's No Jet. They may look like exhaust trails, but the twin streams flowing from the wings of this Schweizer all-metal glider are only water. Carried in wing tanks as ballast to increase wing loading and thereby boost cruising speed, the water is jettisoned through dump valves whenever flight conditions require maximum lift.

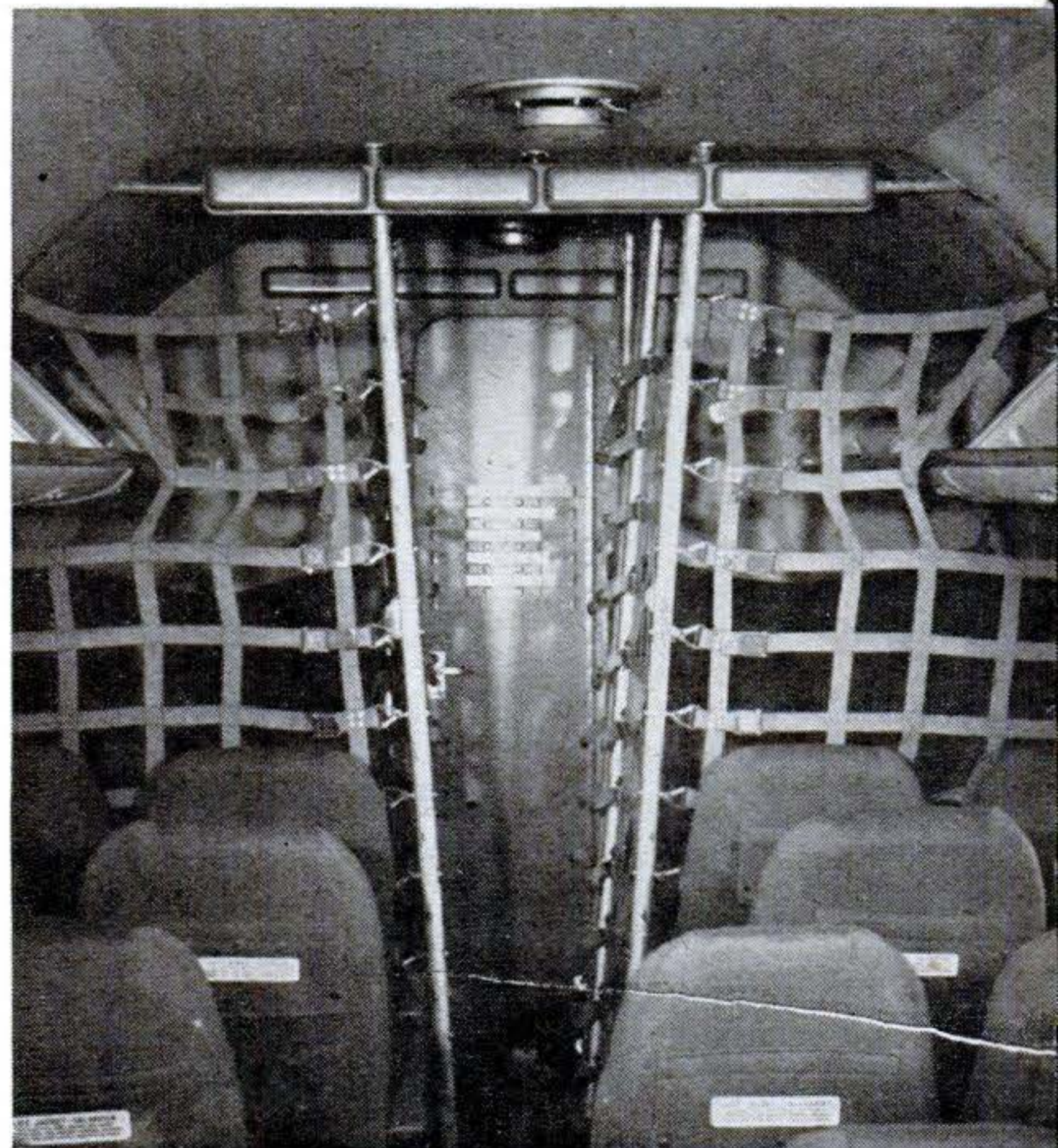

Putting Cargo in the Cabin. To utilize available cabin space, Pan American devised this removable cargo compartment for its Latin American Clippers. Two forward rows of seats are taken out to make room for the stanchions and webbing, which are concealed from the passengers by a curtain when cargo is stowed.

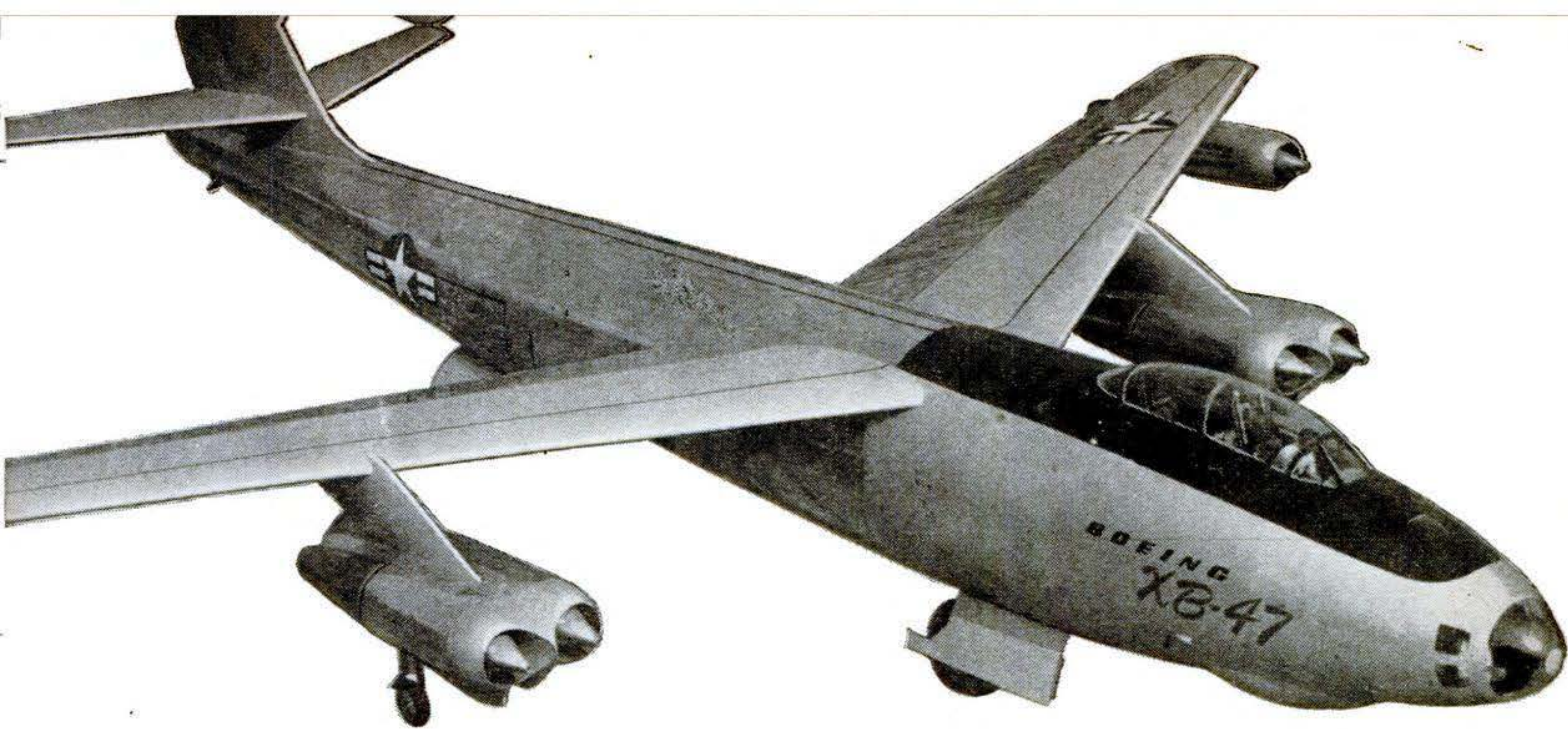

another six-jet bomber designed for the Air Force, the XB-47 has tandem landing gear—main wheels that retract into the fuselage and small outrigger wheels that permit a

thinner, high-speed wing. About the size of a B-29, the XB-47 is 108 feet long and has a wing span of 116 feet. Besides its six jets, it has 18 built-in Jato units.

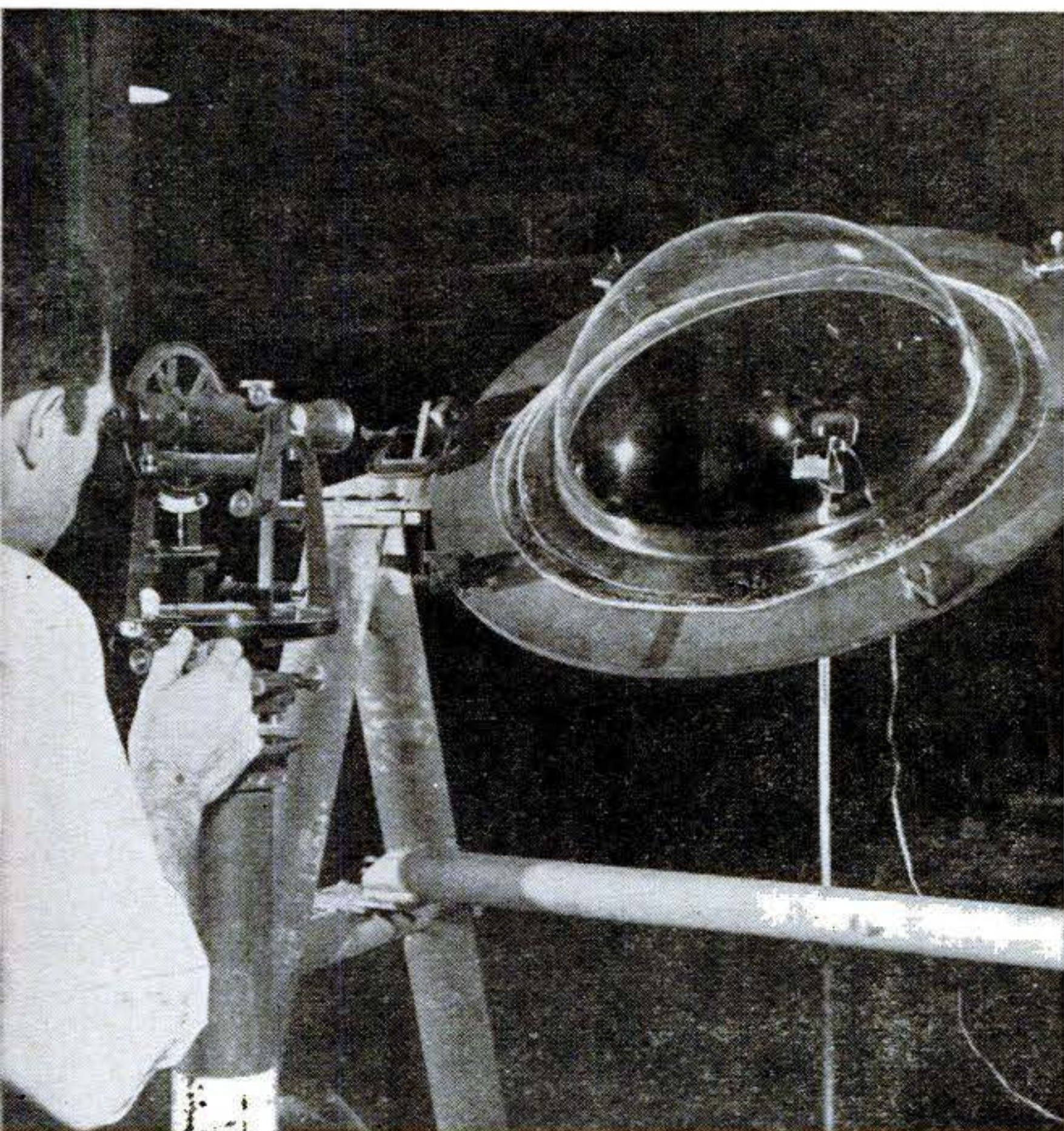

Making Astrodomes Safe. This Northrop engineer is assuring safety for navigators “shooting the stars” through the astrodomes of flying-wing bombers. When the surveyor’s transit is aligned with a light inside the clear plastic bubble, tiny deflections indicate any imperfections that might give way under pressure.

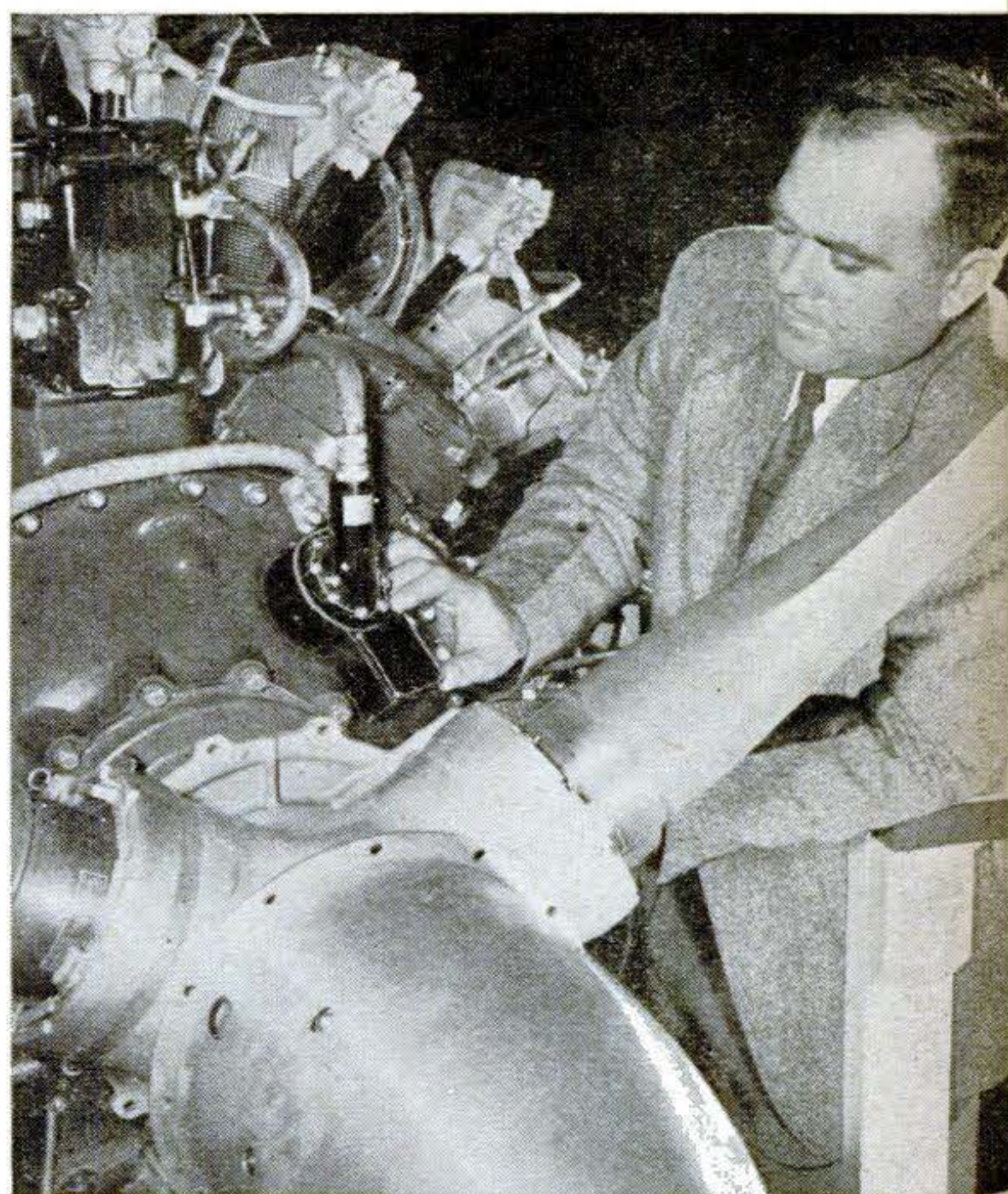

Automatic Feathering. That little black fitting on the aircraft engine shown above holds the key to a new automatic feathering device developed for Consolidated Vultee. Inside it are a torque meter and pressure switch; 1½ seconds after the engine fails, they close a circuit that twists the blades and stills the propeller.



Convertible Freighter. Continuing its versatile line, Britain's Miles Aircraft has turned out the Merchantman, above. Pat-

terned after the earlier Aerovan, the four-engine freighter can be quickly converted into a 20-seat passenger plane.



Wider View for Spotters. The long, two-man greenhouse of Britain's new twin-boom, pusher-type Heston provides an excellent view for artillery observers.



Streak Speeds Up. With a 125-hp. engine, a new version of the Streak 85 is billed as the "fastest personal plane." Cruising speed is given as 192 m.p.h.

Shetland Puts to Sea. New civilian model of one of England's largest flying boats, the Short-Saro Shetland is shown dur-

ing launching. The big-hulled air liner is 110 feet long, has a wing span of 150 feet, and cruises at 184 miles an hour.

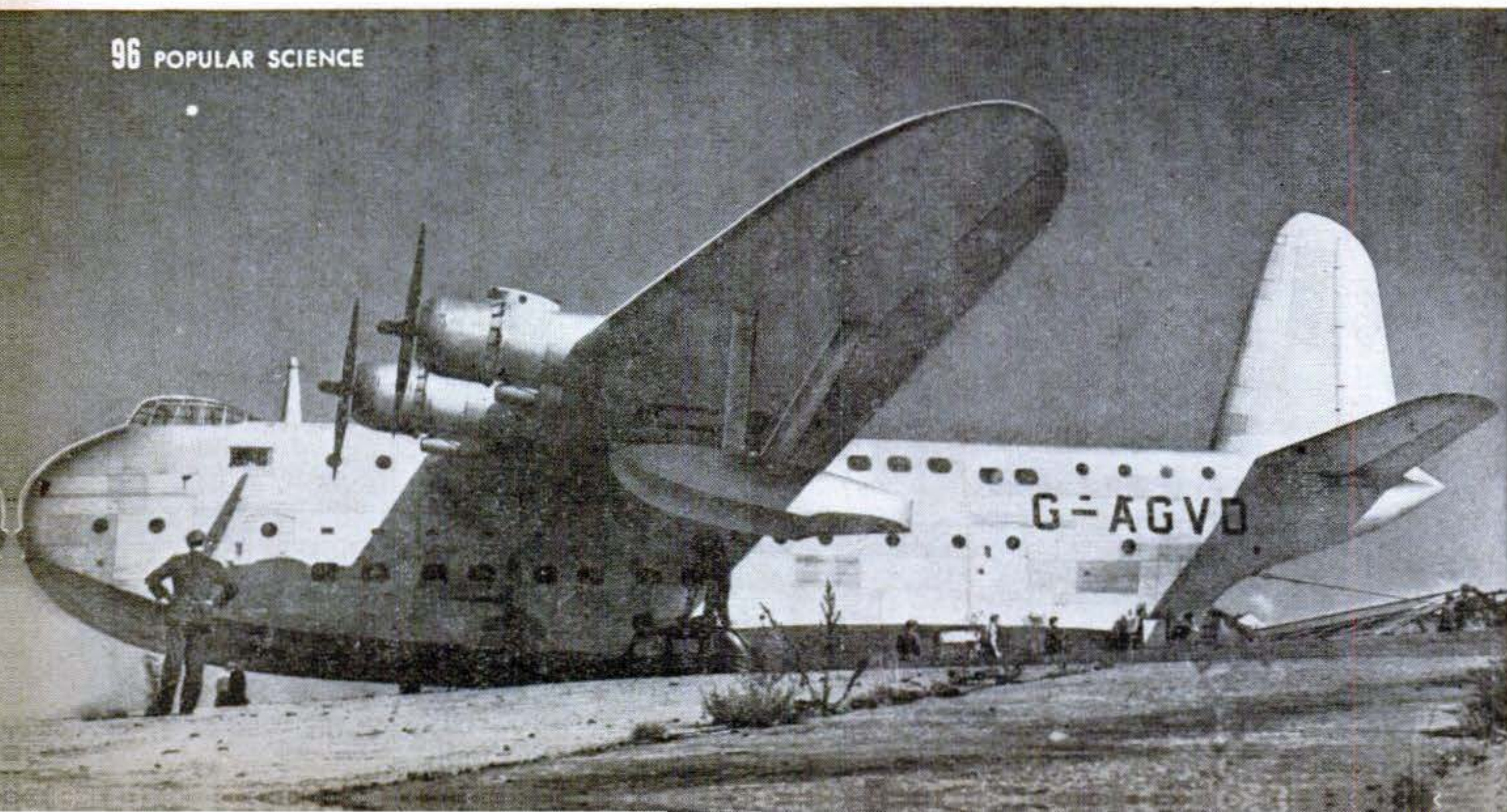



Colonel Gillespie points to push button that started *Robert E. Lee* on automatic flight.

We Flew the Atlantic 'No Hands'

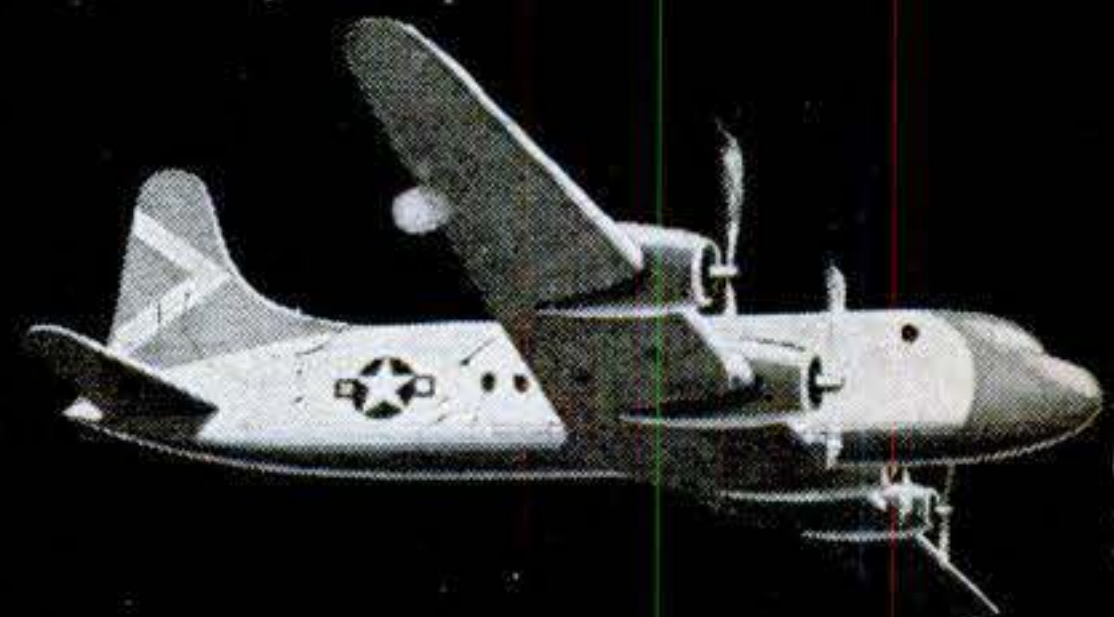

By Col. James M. Gillespie, *Chief, All Weather Flying Division, U. S. Air Force.*

ONE day last September our four-engine transport plane squatted on an airport in the wilderness of Newfoundland. The pilot pushed a button in his cockpit—and then sat back and put his hands in his lap.

The airplane took off by itself. The landing gear retracted itself. The throttles presently crept back to cruising power, though no hand touched them.

The crew of the plane didn't even know its destination. But the plane knew. It headed east out over the Atlantic as unerringly as a hound on a hot scent.

Hours later, this C-54—named the *Robert E. Lee*—automatically banked and began circling. We were in the vicinity of the airport to which the plane was taking us. Presently we were in a glide, pointed straight for the airport. The downwind end of the

runway flashed by. The wheels touched. The throttles cut back to idling speed. Only then did the human pilot, sitting in the cockpit, make a move. With his feet he braked to shorten the landing run. With his hands he kept the plane in the middle of the runway until we rolled to a stop.

We had made the first wholly automatic transatlantic flight in the history of aviation, and I had been lucky enough to be aboard. We had taken off automatically, flown automatically, and landed automatically.

What makes push-button flight possible? What opens and closes the throttles, raises and lowers the landing gear, and points the nose of the plane to its destination? Flight by robot sounds fantastic, even spooky, to the layman.

It isn't, at all. What makes our C-54 work



Entry on electronic brain fixed 12 planned sequences for entire flight in advance. In first, idling power is provided for engines. Pilot takes runway heading manually, then presses button advancing Master Sequence Selector to Position 2.

MASTER SELECTOR BUTTON



No-hands take-off follows as throttles are advanced automatically to take-off power. Runway heading is maintained as the plane lifts off the field. Fifty feet up, the radio altimeter, the sensor now in charge, advances Selector to Position 3.

RADIO-ALTIMETER SENSOR



Plane keeps climbing straight ahead as take-off power is maintained. Auto-pilot sets elevators for 1,000-foot-per-minute climb, and landing gear retracts. At 1,000 feet, radio altimeter advances the Sequence Selector to Position 4.

RADIO-ALTIMETER SENSOR

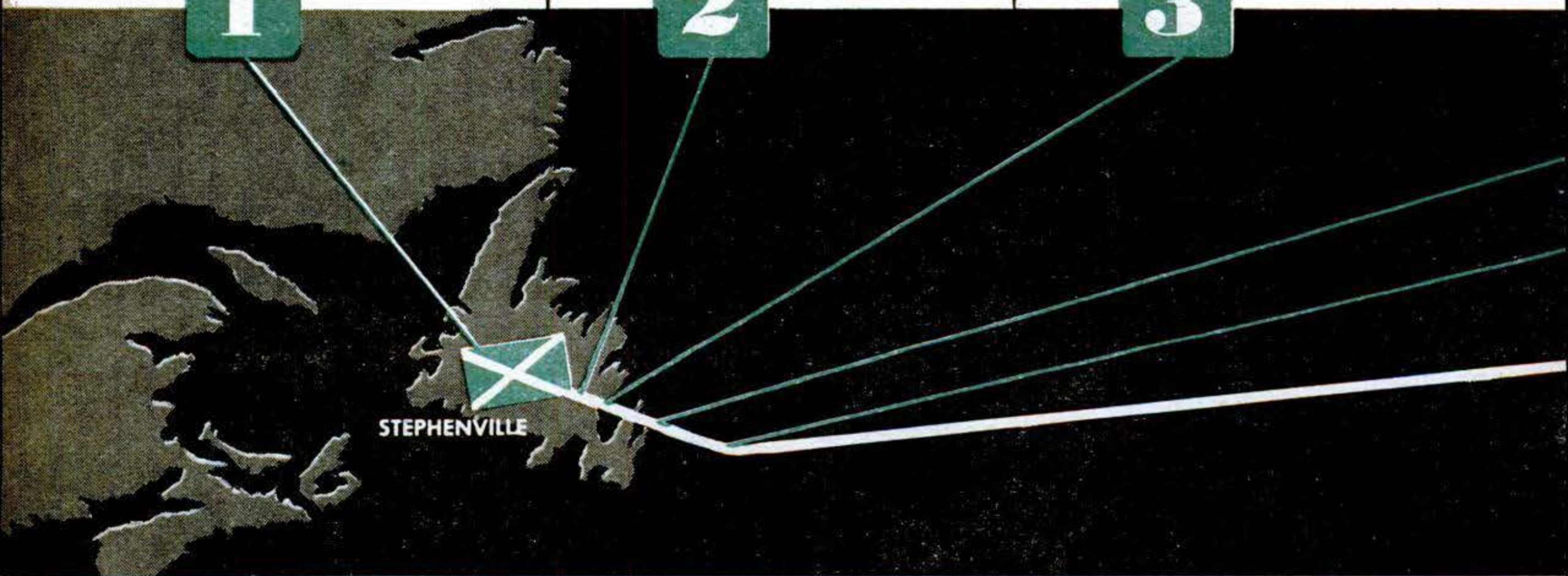

is fundamentally as simple as the thermostat in your living room. The thermostat "senses" that the house is too cool. The furnace is actuated by an electrical command. The same thing happens in the U. S. Air Force's C-54; sensor devices indicate that something is to be done, and an actuating device—an "actuator"—does it.

There was nothing sensational in the way of equipment in the plane. Most of the *elements* of fully automatic flight had been used in aircraft and other vehicles for years. What was new in our plane was that we had taken these elements, put them all together, and added a series of sensing units developed by the personnel of the All Weather Flying Division. It was the *combination*, plus these sensing units built on the chassis of instruments and devices already in use in aircraft, that made automatic flight possible.

When we started our trip to England by way of Stephenville, Newfoundland, our push-button airplane already had proved itself in trial runs here at home. But we knew that flying the Atlantic might be something else again.

There was some tenseness when we neared our first homing radio station in mid-Atlantic. This was a U. S. Coast Guard weather ship on permanent station. About 70 miles from it, according to our air log, we asked the radio operator to hold his key down for 30 minutes so the plane could bird-dog its course.

Would everything work?

It was shortly after midnight, Newfoundland time, as all hands, save for the pilot and copilot who were up in the cockpit, gathered around the master control panel just behind the main cabin bulkhead. Above us the stars were shining. Below us some-



Reaching for the sky, the plane keeps climbing 1,000 feet per minute as flaps are retracted. Compass heading is unchanged. When the predetermined altitude—3,000 to 8,000 feet—is reached, the radio altimeter advances the Selector to Position 5.

RADIO-ALTIMETER SENSOR



4



The navigator relaxes as throttles close to cruise power and plane takes preselected heading. API (air position indicator) begins counting backward from estimated miles of first leg. At zero, near target, Air Log No. 1 selects Position 6.

API SENSOR



5

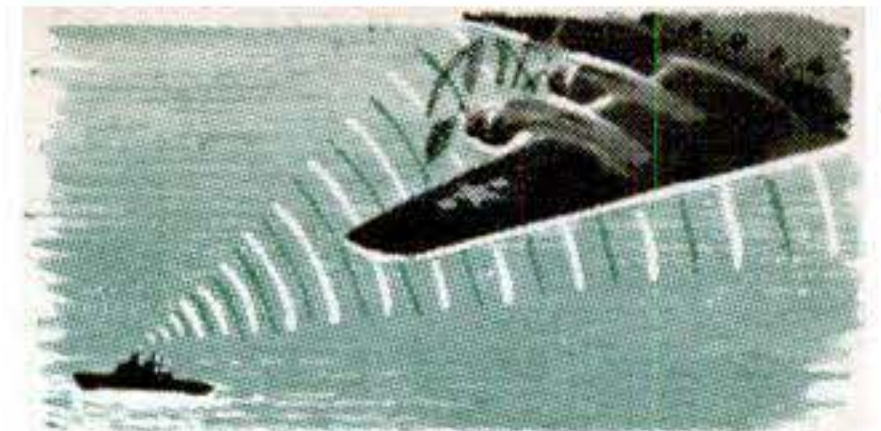

Like a homing pigeon, the plane now "homes" on first preselected radio station. Barometric altimeter controls altitude. As plane passes over radio station it is homing on, the radio compass advances the Sequence Selector to Position 7.

RADIO-COMPASS SENSOR



6

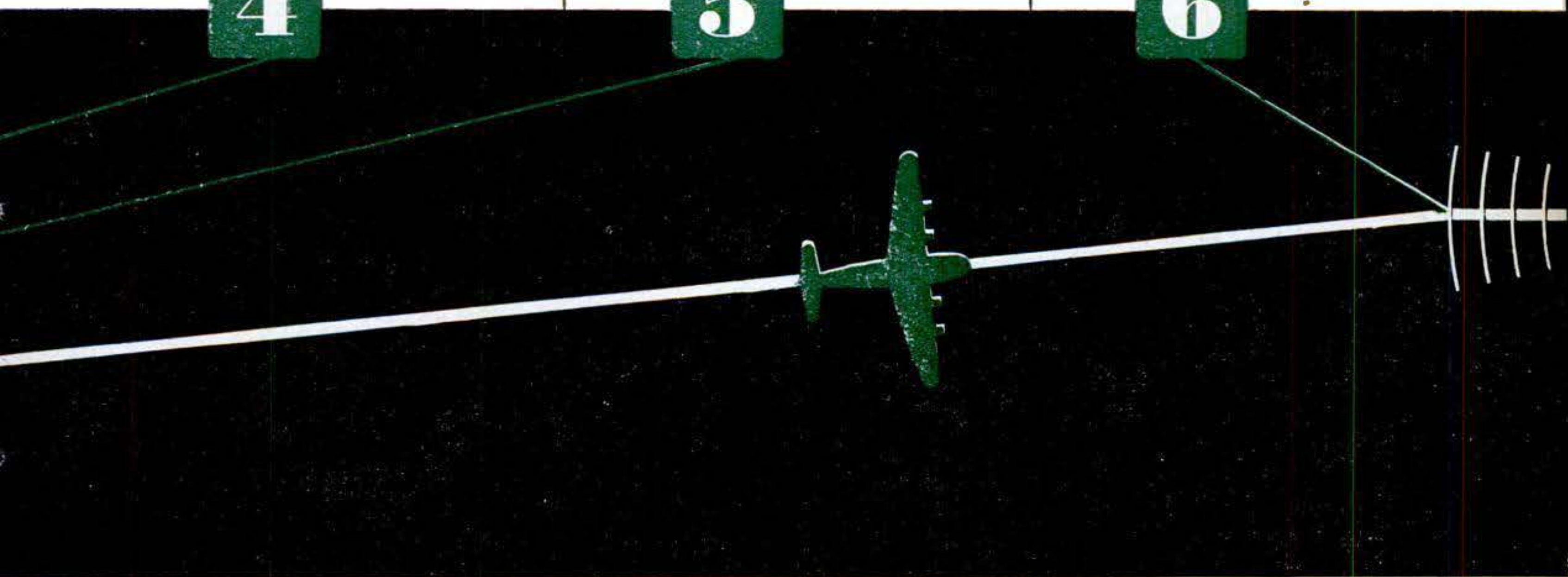

where, rolling in the waves, was a tiny vessel. We couldn't see it. We were too high and our plane swam in darkness.

We couldn't even have the satisfaction of a cigarette. Huge cylinders containing supplementary fuel were at our elbows.

On the radio signals from that unseen vessel depended our automatic "fix" in uncharted space. From that point we would proceed to our second air-log sequence. Eyes were trained on a compass needle.

Then everything happened at once. An amber light flashed on the control panel. The sequence was advancing. The compass needle crept around. The plane banked gently, assuming a new course. Nobody said anything. We just exchanged glances. The smile that was passed around contained, perhaps, as much relief as gratification.

But men's faith must be renewed periodically. Again, over the patchwork quilt of

fields that was England, we gathered around the master control panel. Our concern was justified. The Royal Air Force had installed the USAF Instrument Low-Approach System (SCS-51) with only cabled instructions. Would there be a hitch?

The airplane crossed the radio station that had led it in. We knew that had happened when the needle of the radio compass—standard equipment in all transports—swung around 180 degrees and pointed backward. It said, "Wait a minute! Your destination is back there!"

The ordinary radio-compass needle is a non-metallic luminous pointer. Ours, however, was made of metal. As it swung, it closed a switch, just as you would switch on an electric light. The compass, of course, was the sensor. Closing the switch put an actuator into operation.

A signal was fed through to the auto-



With uncanny precision, the plane now changes course automatically and takes preselected heading for second leg. Air Log No. 2 starts counting estimated air miles of this leg. When zero is again reached, API advances the Selector to Position 8.

API SENSOR

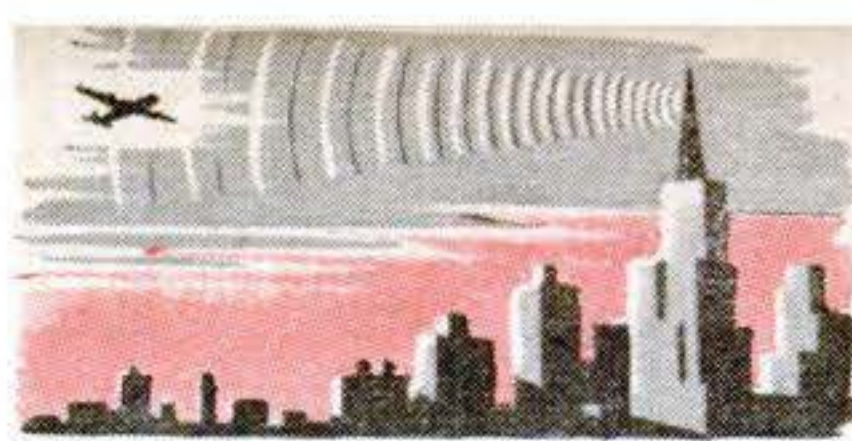

On the last lap, plane homes on the second preselected radio station, located 15 miles from the approach end of the runway at final destination. Radio compass sensor now automatically advances the Sequence Selector to Position 9.

RADIO-COMPASS SENSOR



The ghost pilot now reduces plane's power to provide a 500-feet-per-minute descent and craft circles radio station at radius of five miles or less. When 2,000-foot altitude is reached, radio altimeter advances the Sequence Selector to Position 10.

RADIO-ALTIMETER SENSOR

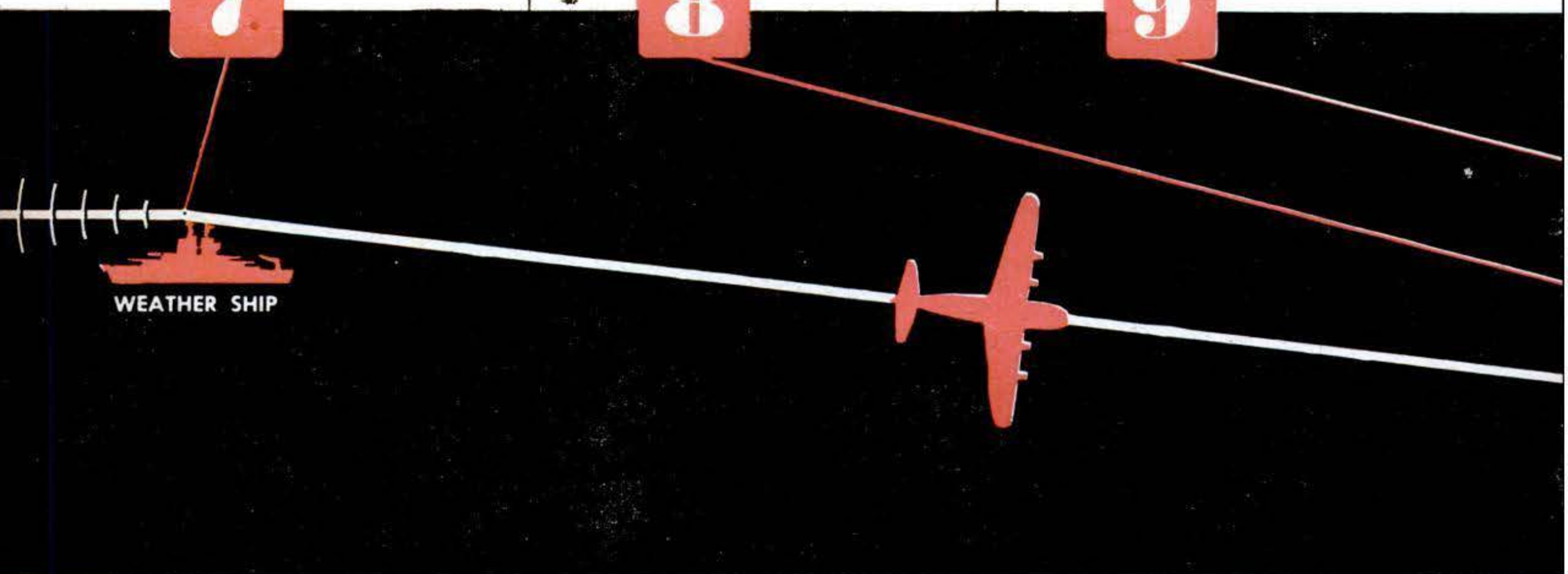

pilot in the cockpit. The autopilot, controlling the ailerons and rudder, put the plane in a gentle bank around the radio station. The signal simultaneously actuated another electric servo system that retarded throttles to the proper setting for a glide.

Some other things were happening. The plane had been kept at a constant altitude through a barometric pressure altitude control of the autopilot—another of the plane's sensory organs. Now, as the throttles came back for the glide, the barometric pressure sensor was switched off. The plane orbited and started downstairs.

A radio altimeter stepped in as another in the series of sensors. The wheels came down—automatically. The plane's nose picked up the runway localizer of the SCS-51. Then it found the second part of the landing system, the glide path, the invisible highway leading to the runway.

Through the haze we could see that we were landing at the RAF Brize Norton Field. The British had done their work well.

We repeated the experience, giving our plane its head westward back across the Atlantic. Except for three occasions, when proper radio facilities were lacking, the entire round trip was by push button.

While I was the senior officer aboard, the operation of the aircraft was in the hands of seven men headed by red-thatched Capt. Thomas J. Wells, the chief test pilot. He was ably assisted by James L. Anast, chief of the automatic flight branch of the All Weather Flying Division; Captain R. J. Whiting, navigator; T/Sgt. Welker W. McKee, the crew chief; S/Sgt. John C. Nimon, engineer; T/Sgt. Raymond Centolella, radio operator; and George B. Johnson, technician.

There are only a dozen sequences, or phases, fed into the Automatic Flight Con-



To line up for landing, the plane now seeks the landing system runway localizer and glide path. Landing gear and flaps are extended. Altimeter keeps plane at 2,000 feet until it crosses the glide path sensor. This advances Selector to Position 11.



Coming in, the directional and glide-path course is maintained. Three-point landing attitude is set by pitch-reference signal. Contact with runway operates a microswitch in the right landing gear, advancing the Selector to Position 12.



The ghost cuts the engine to idling speed, as the human pilot applies brakes to shorten landing run, and uses controls to keep plane on the runway. Operation now returns to manual so pilot can taxi plane off runway to parking position.

GLIDE-PATH SENSOR



10

MICROSWITCH SENSOR



11

PILOT APPLIES BRAKES



12



troller. The system can be modified at will. The fuel-mixture and cowl-flap operations are manual now. Those can be made automatic. Right now the airplane touches down on its two main wheels and its nose wheel. That makes a landing a little rough. It will be simple to add another relay to make the elevator "flare out" the landing at about 50 feet, just as a human pilot does in touching down on the two main wheels first.

Yet wholly automatic flight does remain experimental. And it is misunderstood by the public. Our C-54 airplane has no relation whatsoever to the guided missile program. The automatic airplane is *not* a guided missile. It is an inhabited plane that has been fixed up for safe, automatic flight. Perfected, it will represent a vast advancement in the art of flying. Today when ceilings and visibility come down, flights are canceled wholesale in the inter-

ests of safety. Automatic flight is going to make flying safe, in any weather.

Crewmen on experimental automatic flights are really along for the ride. Of course they have to monitor the equipment and keep notes on performance. When off duty they may play a little gin rummy. George Johnson pocketed 35 cents on the flight from England to Newfoundland.

But he worried more about his cards than about the operation of the *Robert E. Lee*. You see, he wasn't sure of his cards. **END**

Helium: \$2,500 to 1½ Cents

HELIUM cost \$2,500 a cubic foot when it was a laboratory phenomenon 30 years ago. Today 1½ cents buys a cubic foot of helium extracted from natural gas at the government's four plants in Kansas, New Mexico, and Texas.

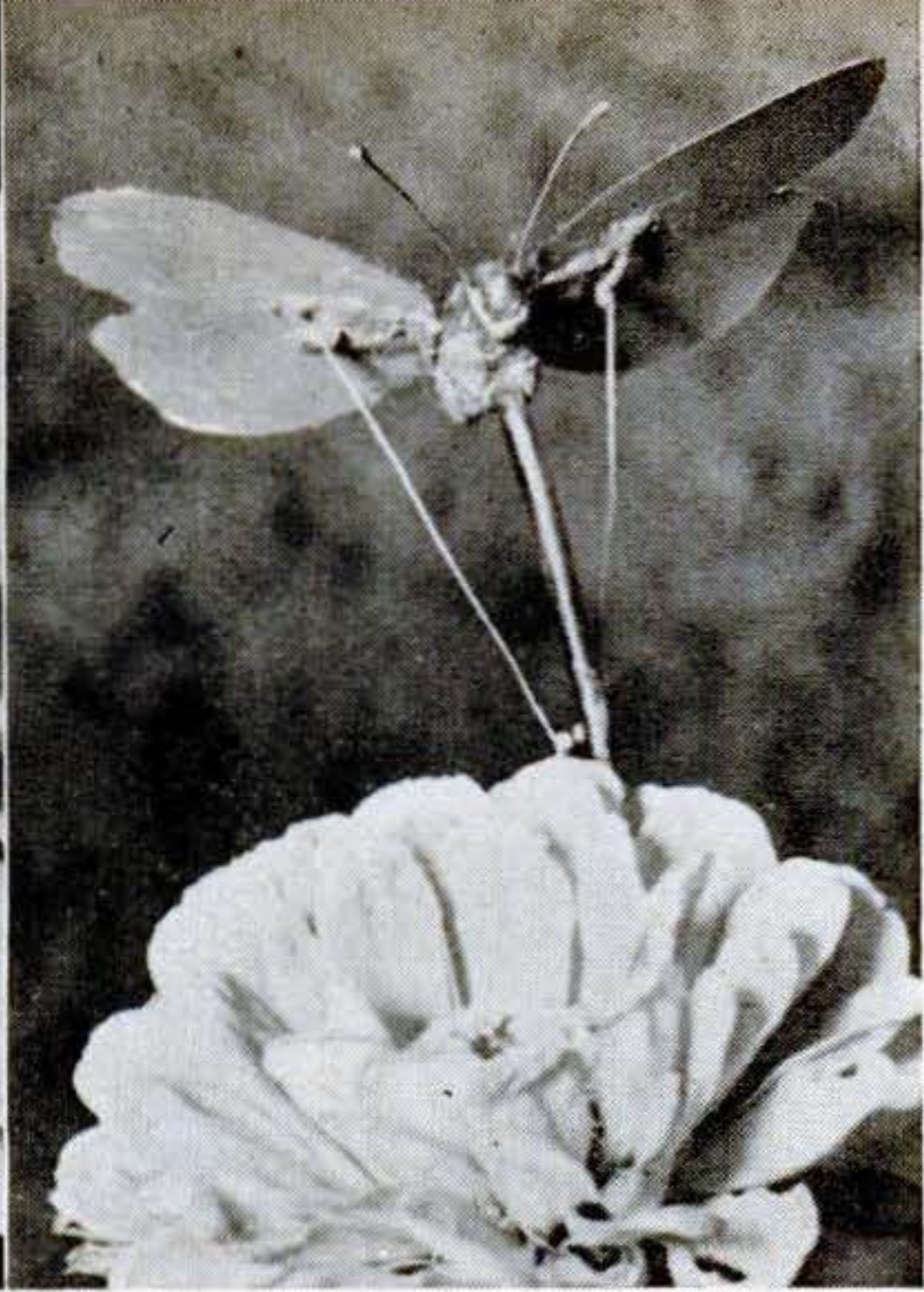
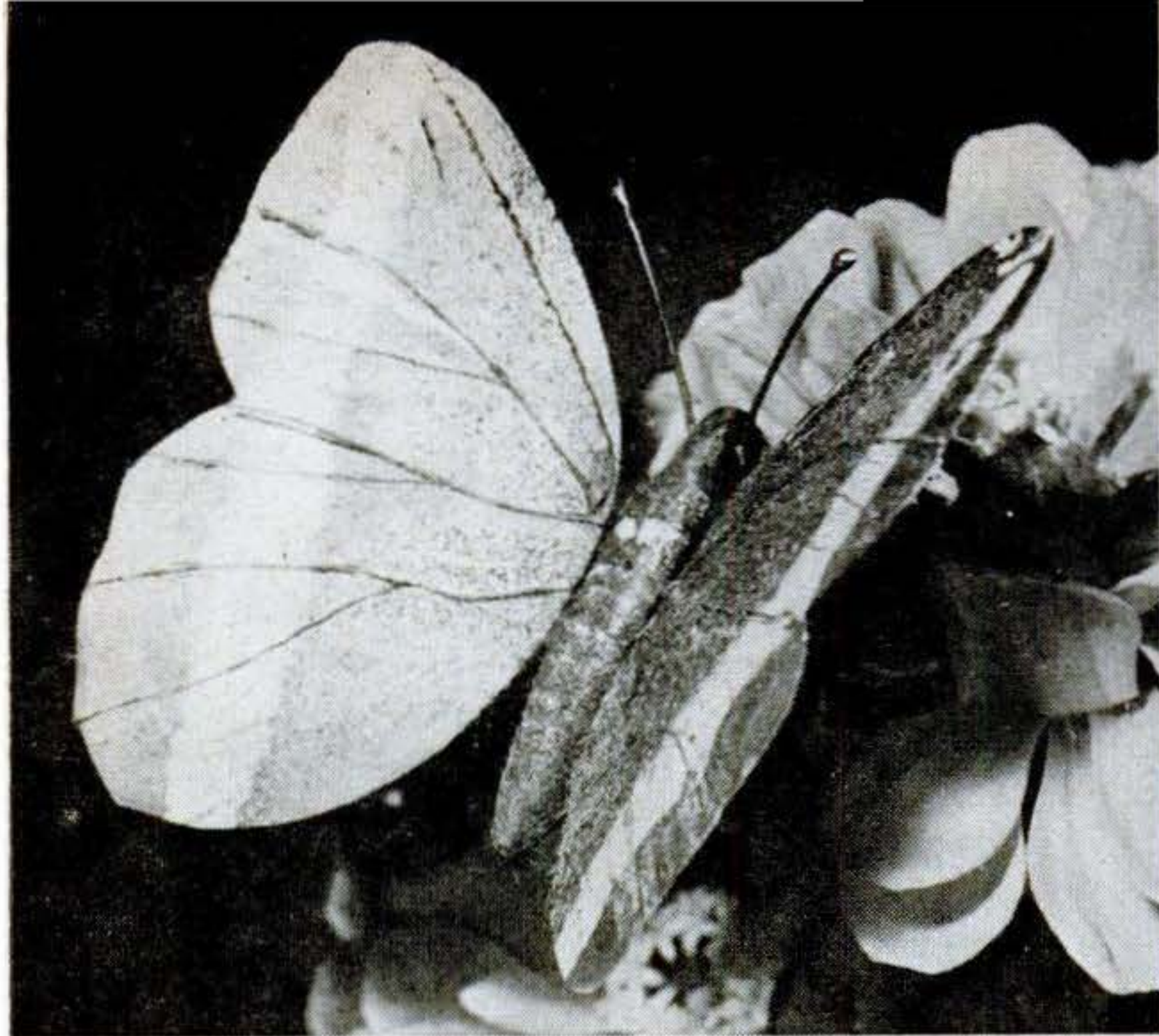

Mechanical Butterfly

WHEN Hollywood couldn't deliver a trained butterfly called for in a movie script, studio mechanics came up with this metal one, wired for action.

The wings are made to flutter by remote control, out of camera range. As shown at right above, two thin metal strips are at-

tached to the hinged wings of the imitation insect. Four inches below the wings, the strips are joined and attached to a piano wire running through a long copper tube. Pull the wire, and the butterfly performs. This model represents the butterfly poised upon a flower, as in the picture at left. Another version, attached to a traveling boom, simulates a butterfly in flight.

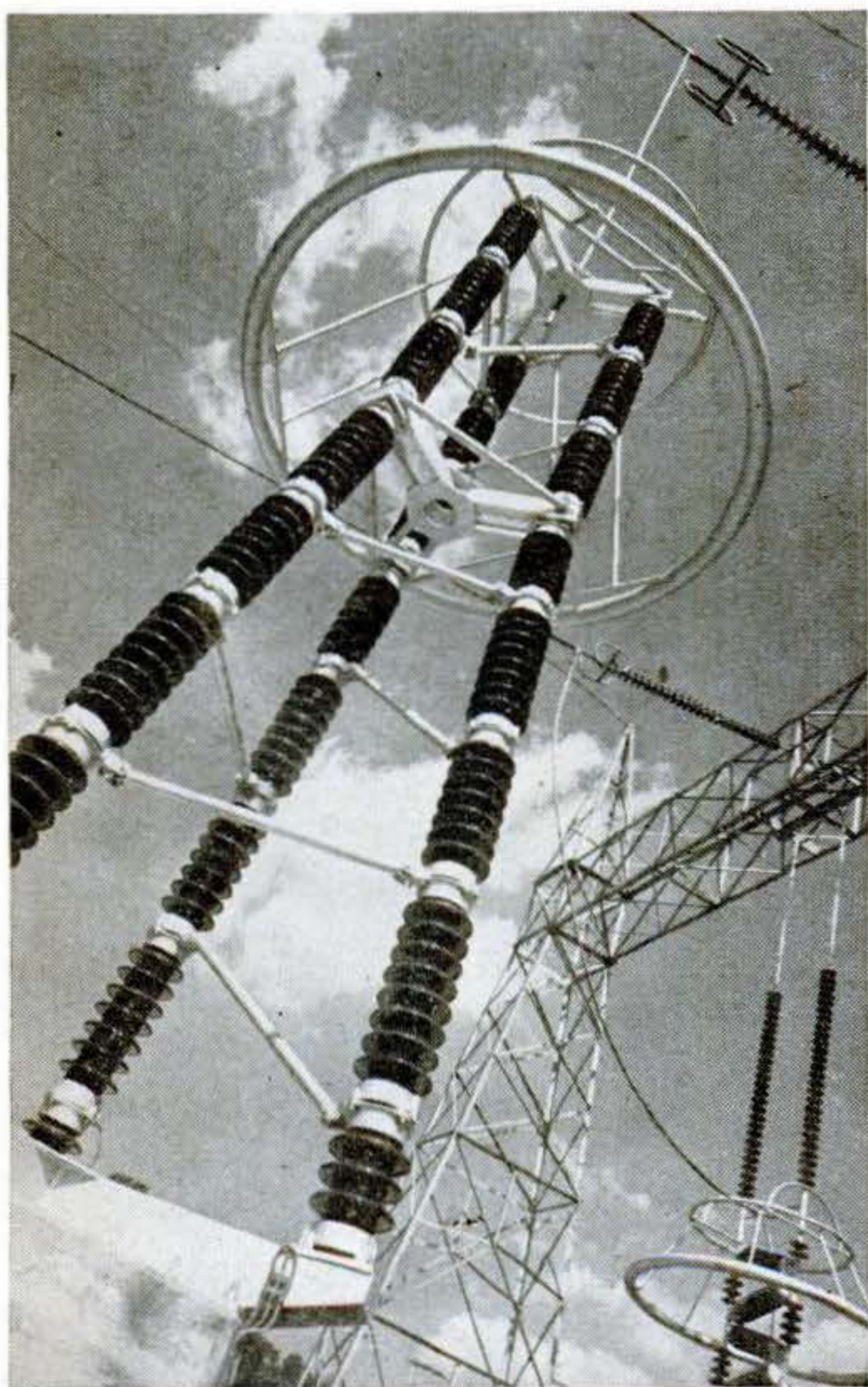

Thunderbolt Tower

GIANT "tripod" at left is world's largest lightning arrester, its three 29-foot-high legs designed to carry thunderbolts harmlessly to the ground. Constructed by Westinghouse, it is installed on a 500,000-volt test transmission line in Ohio to protect delicate equipment. One of two other arresters is visible at lower right.



Guess Which Is Real

Look alike, don't they, these two star rubies? But the one on the left is a natural stone, valued at \$12,000, while the one on the middle finger is synthetic, worth about \$600. Developed for industrial use, synthetic star rubies and sapphires will soon be on the market as jewelry.

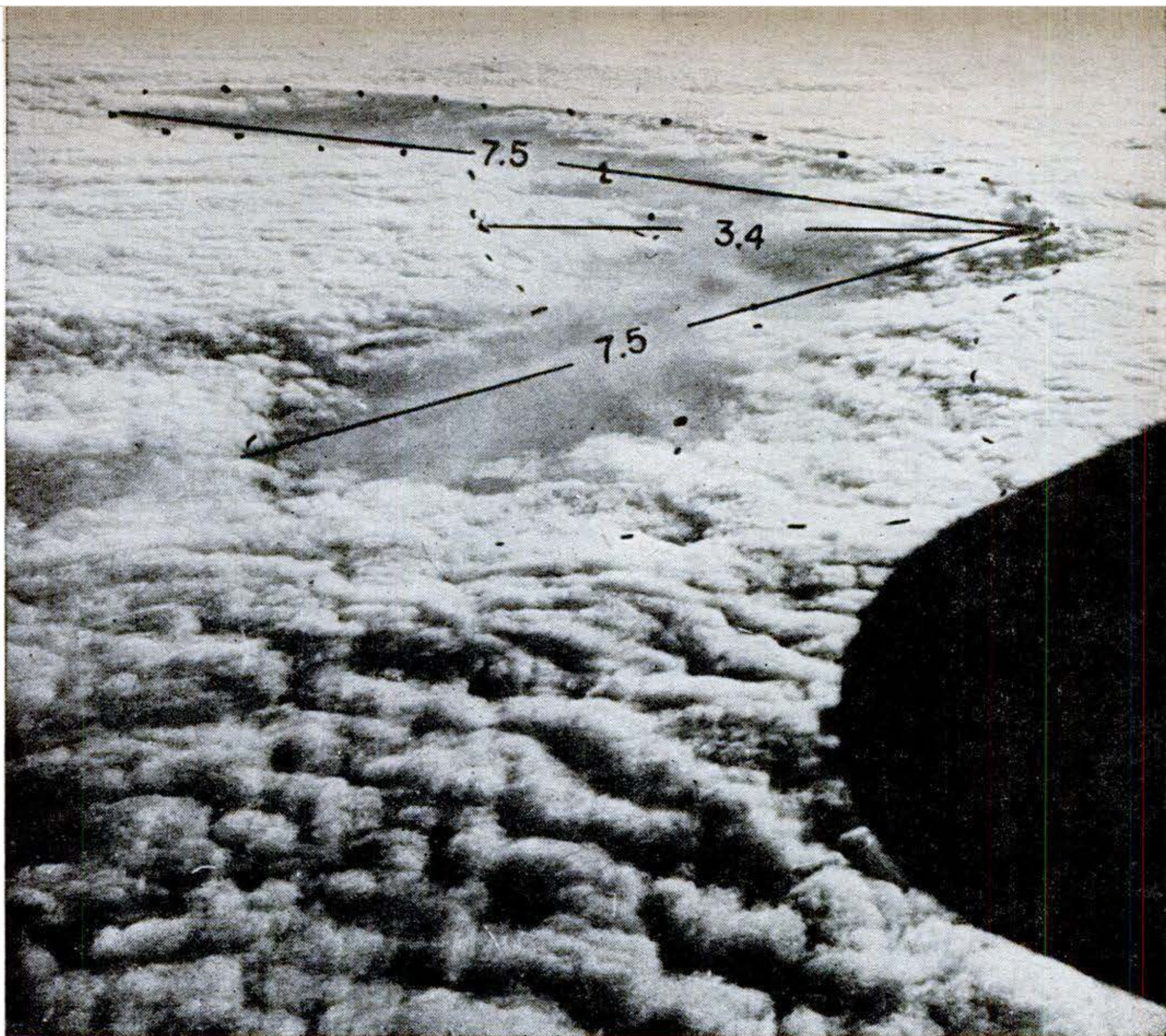

Chopping a hole in a cloud. A few pounds of dry ice were enough to clear this rift in an ice-forming cloud. It is 15 miles long and three

miles wide—twice the size of Manhattan Island. An airplane can drop into the opening without collecting ice on its wings or control surfaces.

“Sanding Roads” for Planes

SCIENCE'S snow makers are crossing ice off the list of flying dangers by removing the supercooled clouds that cause the ice to form on wings and control surfaces. They “sand” the clouds with ordinary dry ice—and in 15 minutes there is a hole big enough for a plane to land through.

Capt. Clarence N. Chamberlain, Jr., pilot of the Air Force plane used in the first cloud-boring test, said, “The hole looked like someone had taken a giant shovel and scooped out a large section of the cloud.”

As reported in *Popular Science Monthly* last June, prevention of airplane icing was one of the many developments expected from the method of weather control discovered by Dr. Irving Langmuir and Vincent J. Schaefer of the General Electric Co. (see “The War Against Hail,” PSM June '47, p. 82). This method already has brought

rain to drought-struck areas in Illinois and Arizona, and Dr. Langmuir believes it can be adapted to change the entire winter climate of large sections of the country. It may also prevent costly hailstorms.

Schaefer is now working on a gun to shoot dry-ice bullets straight ahead from the nose of an airplane flying inside an ice-forming cloud. The bullets would continuously clear an ice-free path for the plane. The dry ice would change the cloud, composed of very tiny droplets of water below the freezing temperature but still unfrozen, into snow by chilling the droplets until they froze. Once started, the reaction would keep going by itself, and the cloud would disappear into snowflakes. The research program, called “Project Cirrus,” is being sponsored jointly by the Army Signal Corps, Navy, Air Force, and General Electric.

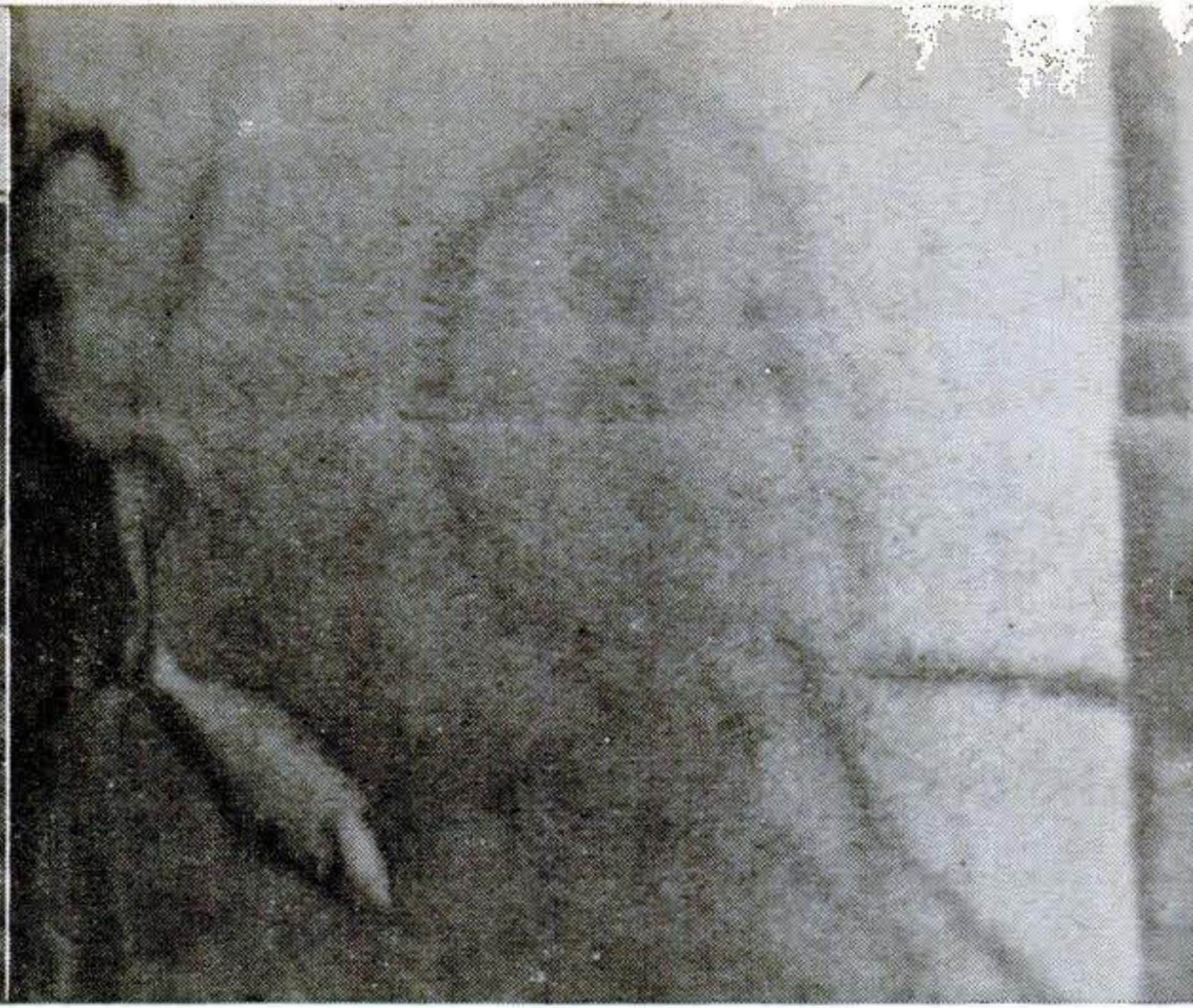
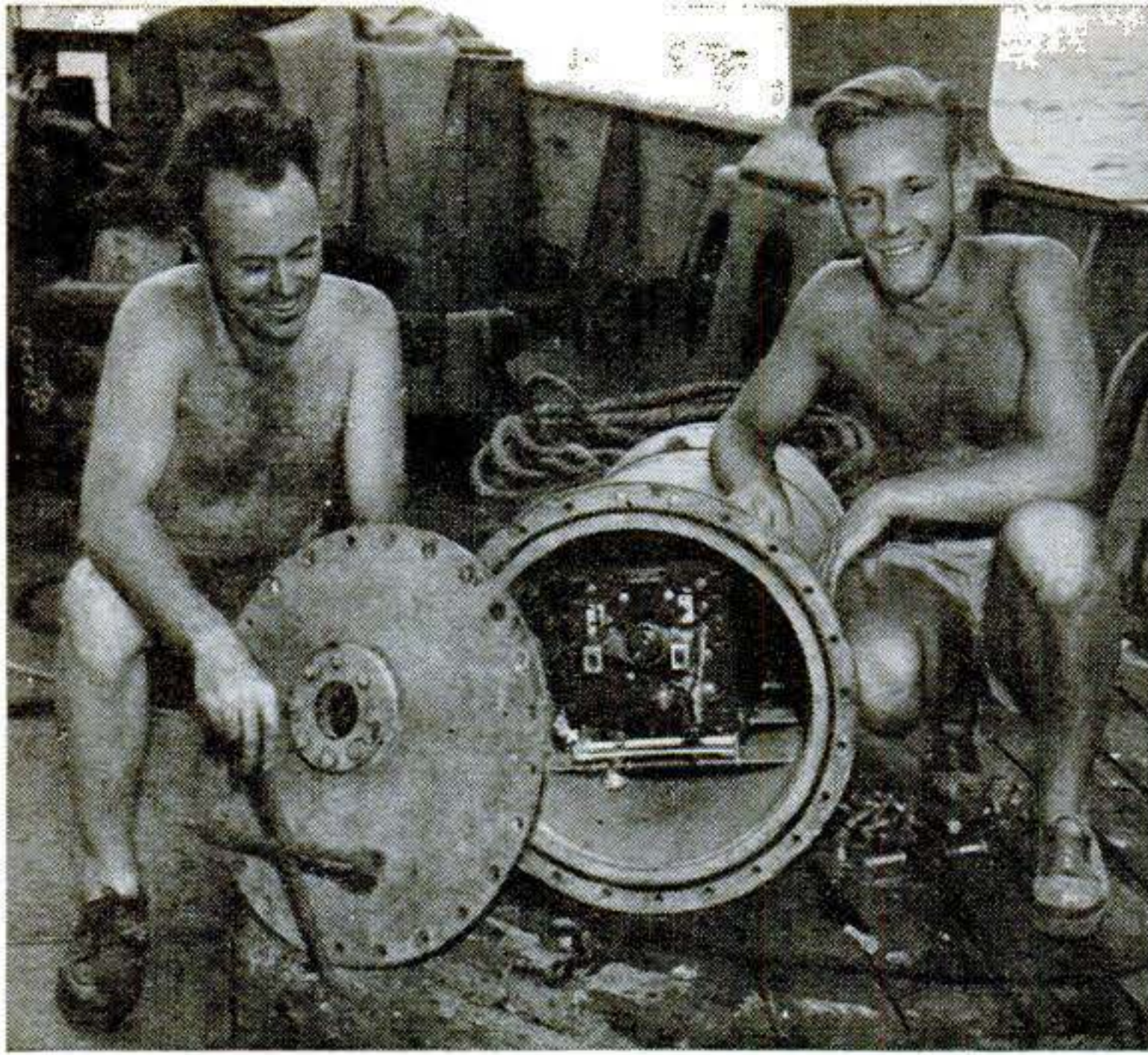

Underwater Television

THE bottom of Bikini lagoon was televised during a recent scientific resurvey of the atomic bomb test area. Above left the television camera is shown inside its steel housing. With the cover bolted on, underwater scenes were photographed through glass

panel in the center. Television receiving equipment was installed on a submarine on the surface where scientists watched the screen, which resembled a window in an aquarium. Scene above right shows a tropical fish swimming in front of lens; lines and debris from sunken target ship are in background. Camera used only natural light.



Sheets Warm Beds

THIS new low-priced electric bed warmer, developed by Westinghouse, works like an electric blanket, but costs less because the coils are sewed into muslin sheeting. The electric sheet is placed on top of the regular sheets and covered with an ordinary blanket. An ornamental "powder box" holds the automatic control for even warmth.

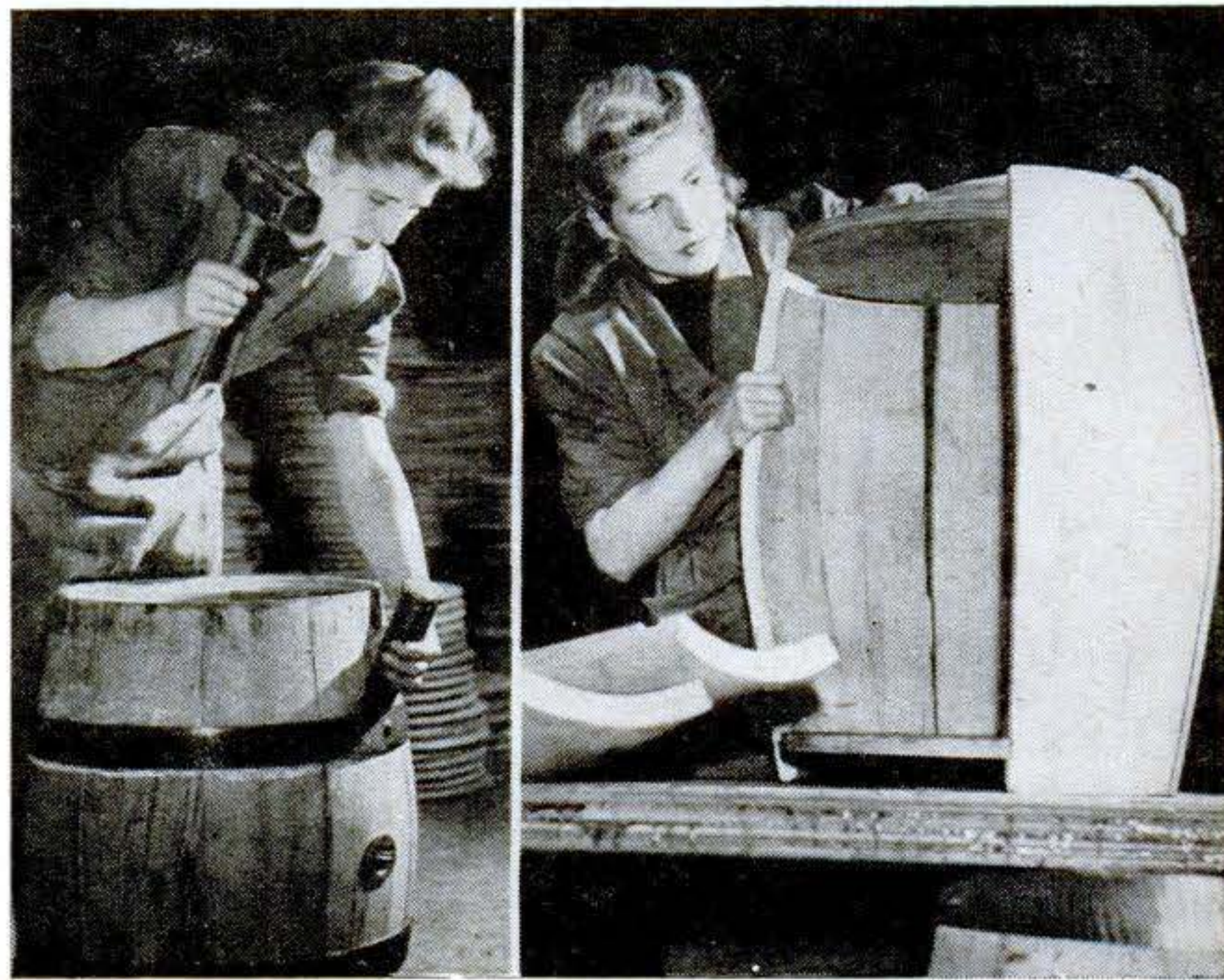

Barrel Comes Apart

FACED with the high freight cost of returning empty barrels, the British have come out with a collapsible model. It is assembled by fitting 10 oak-lined, laminated-plywood staves into the grooves in the ends (right above). The job is completed by hammering hoops home (left above). To collapse the barrel, hoops are knocked off.

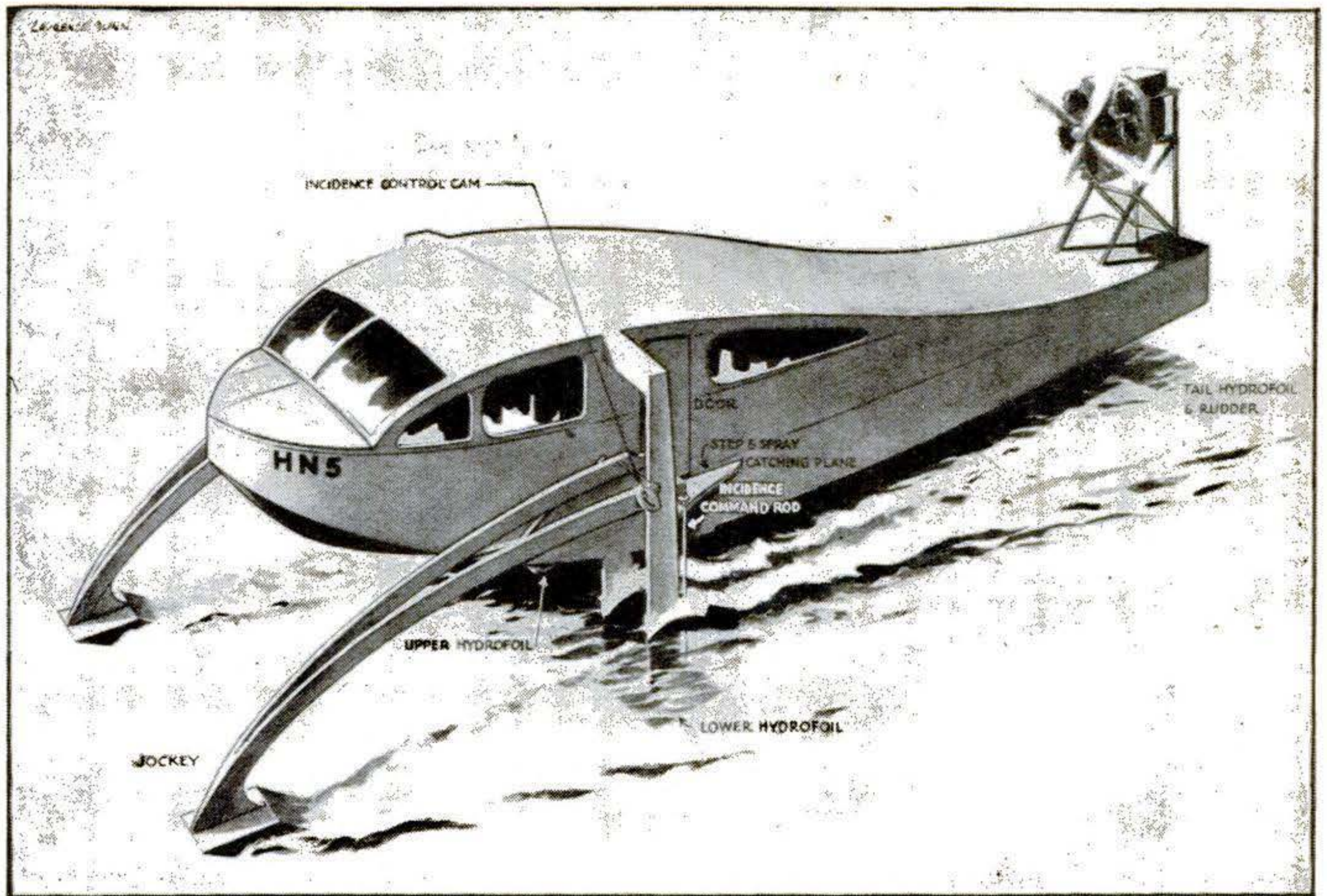

This odd-looking boat uses aircraft engine and prop, plus water version of airfoil for lift.

Buglike Boat Rides the Waves

THE "feelers" jutting out from this novel boat follow the ups and downs of waves and troughs. In turn these "jockey" skids change the angle of the hydrofoils to provide extra lift so that the Hydrofin boat rides the wave crests in rough water. The result is a smoother, faster ride, according to the craft's British inventor, Christopher Hook. The first commercial model, expected to be in coastal service early next year, will be 30 feet long, and will accommodate a dozen passengers plus a crew of two.

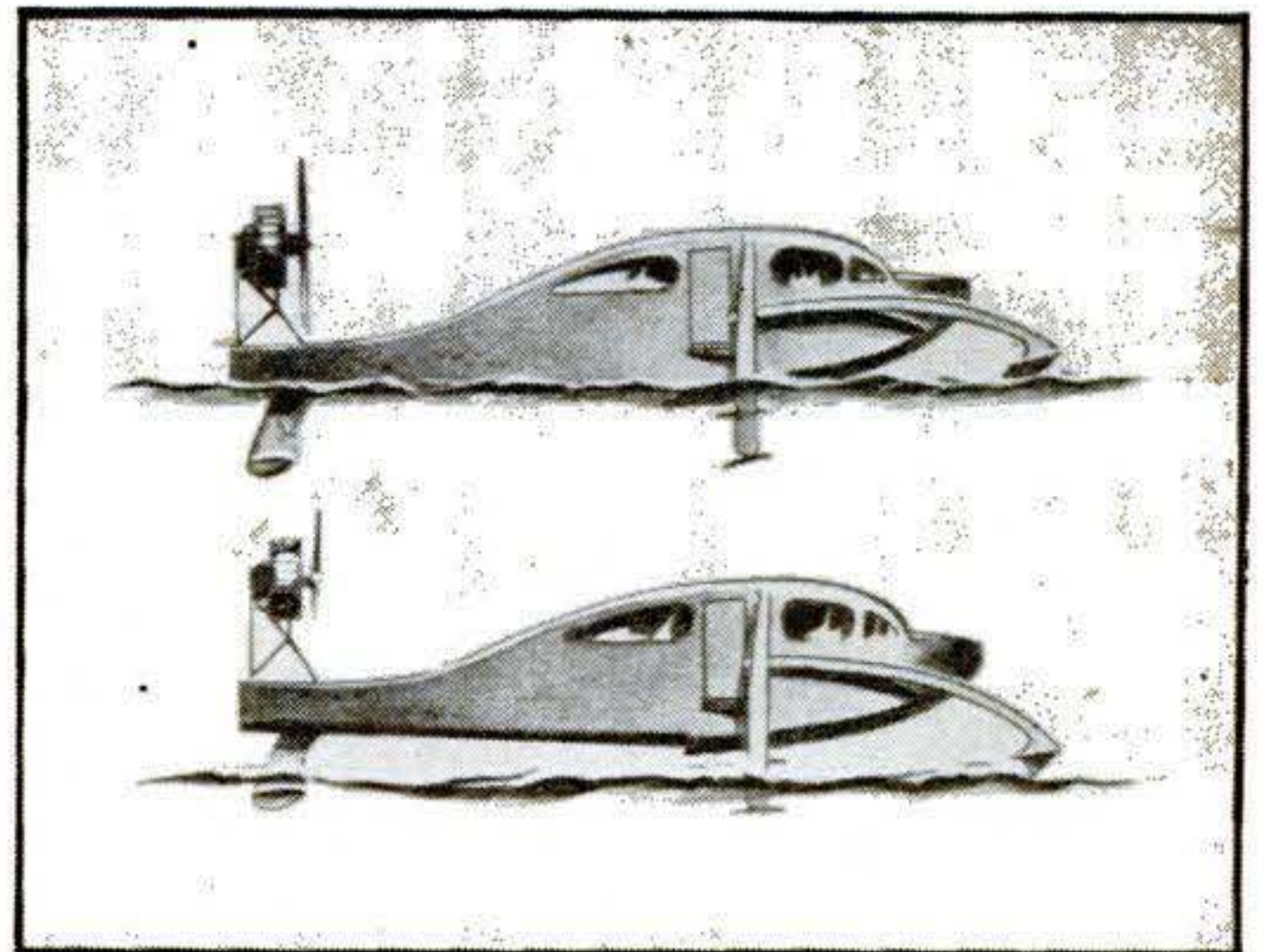

Top picture shows Hydrofin at rest, its hull in the water. In lower picture it gathers momentum and hydrofoils lift the hull out of the water, cutting water drag and adding speed.

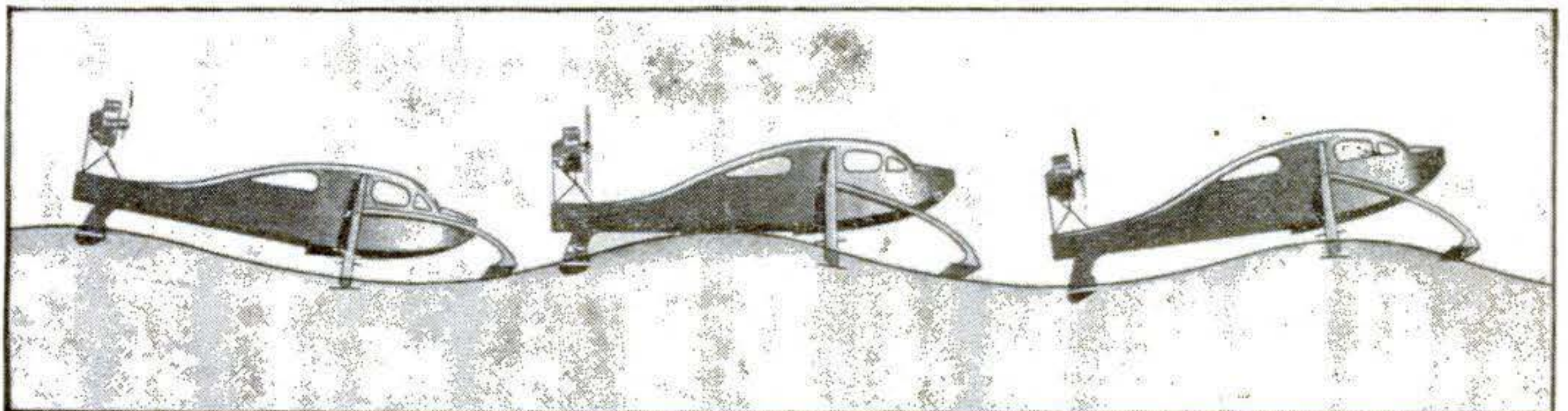

These pictures show how the Hydrofin climbs even the short waves of choppy seas as a car would climb a hill. The varying angles of the

underwater hydrofoils, activated by the advance team of jockey beams, do the job. Outboard aero engine is an Armstrong-Siddeley Cheetah.

How to Make Two Bits

THE coins you jingle in your pocket may not buy much nowadays, but to Uncle Sam they are big business. Only by using modern mass-production methods can his money factories keep up with the demand.

Making a quarter today doesn't take too much hand work—unless you're a counterfeiter. Then you'd appreciate that making money the mint's way is a job of fine craftsmanship. More than two billion coins from half dollars to pennies, valued at more than 77 million dollars, were turned out last year. And every one had to be up to par in weight and alloy. That's not just pride in fine metalwork, but so that your nickel won't be rejected by pay phones, cigarette machines, turnstiles, and other coin devices.



1. From a glowing crucible, a mint worker dips alloy and pours it into molds. When cool, the metal will be in the form of "coinage ingots" 12 inches long, two inches wide, and one-half inch thick. The alloy consists of nine parts silver to one part copper—the copper makes the coins tougher. Each ingot must meet rigid assay tests for purity.



4. Here the output of the cutting machine is being dumped into a riddle, or large sieve. As it rocks back and forth any scraps of silver and broken or off-size blanks drop through the wire mesh into a salvage box. The metal, hardened from the rolling, next goes into an annealing furnace where it is softened by subjection to high temperatures. Cleaning comes next.



5. Emerging wet from a chemical cleaning solution, the blanks are dumped into this drier. A few whirls and they come out gleaming, looking like silver for the first time. From here they are fed into an "upsetting" machine that gives the blanks the raised rims. Precision again is paramount, for with uneven rims the finished coins would not stack properly.

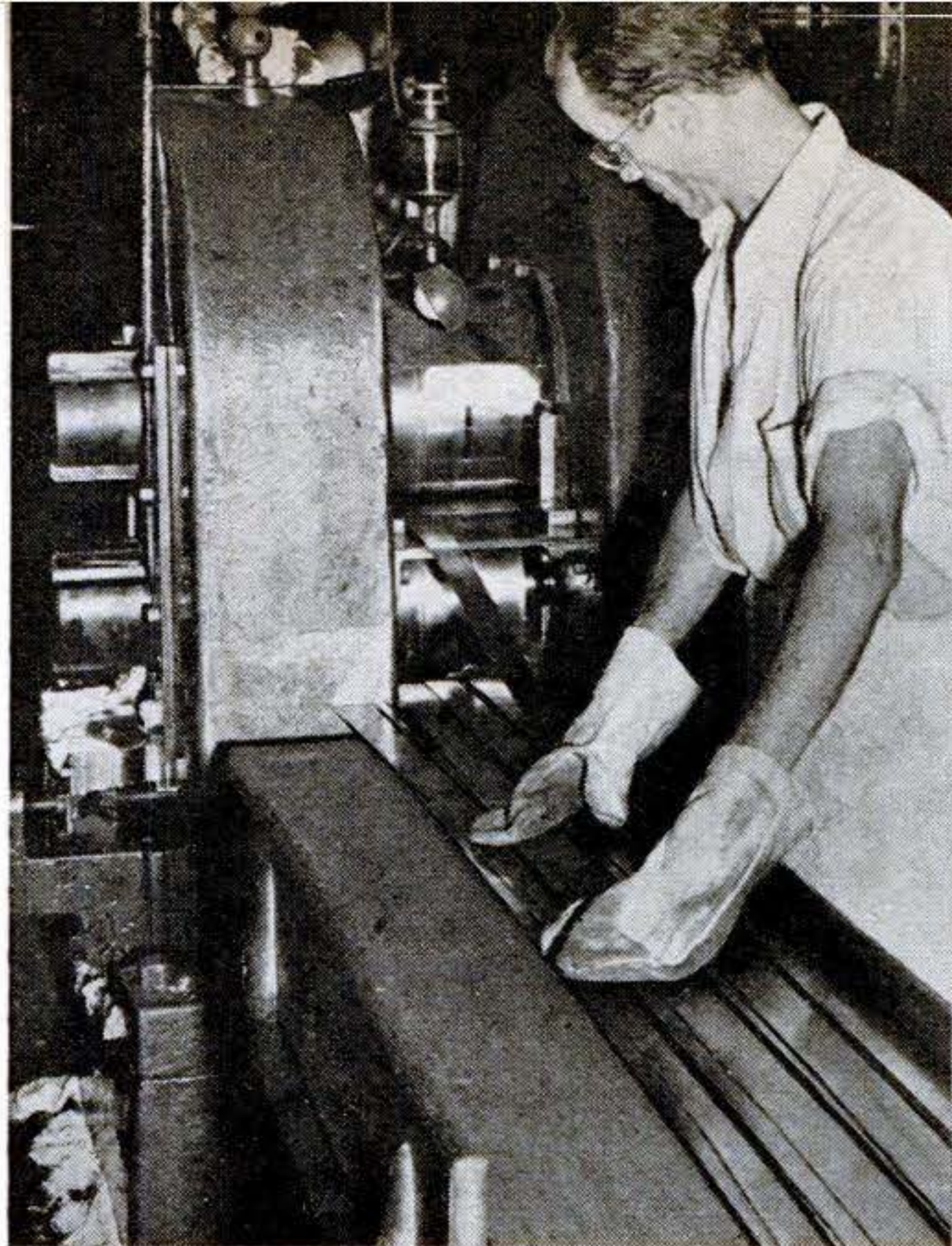

2. The metal starts on its way to become a quarter. Here the coinage ingots are passed through rolling machines that reduce their thickness to about that of a finished coin. The process results in strips eight to 10 feet long, and a little wider than two coins. At this early stage of production the working metal resembles zinc more than it does silver.

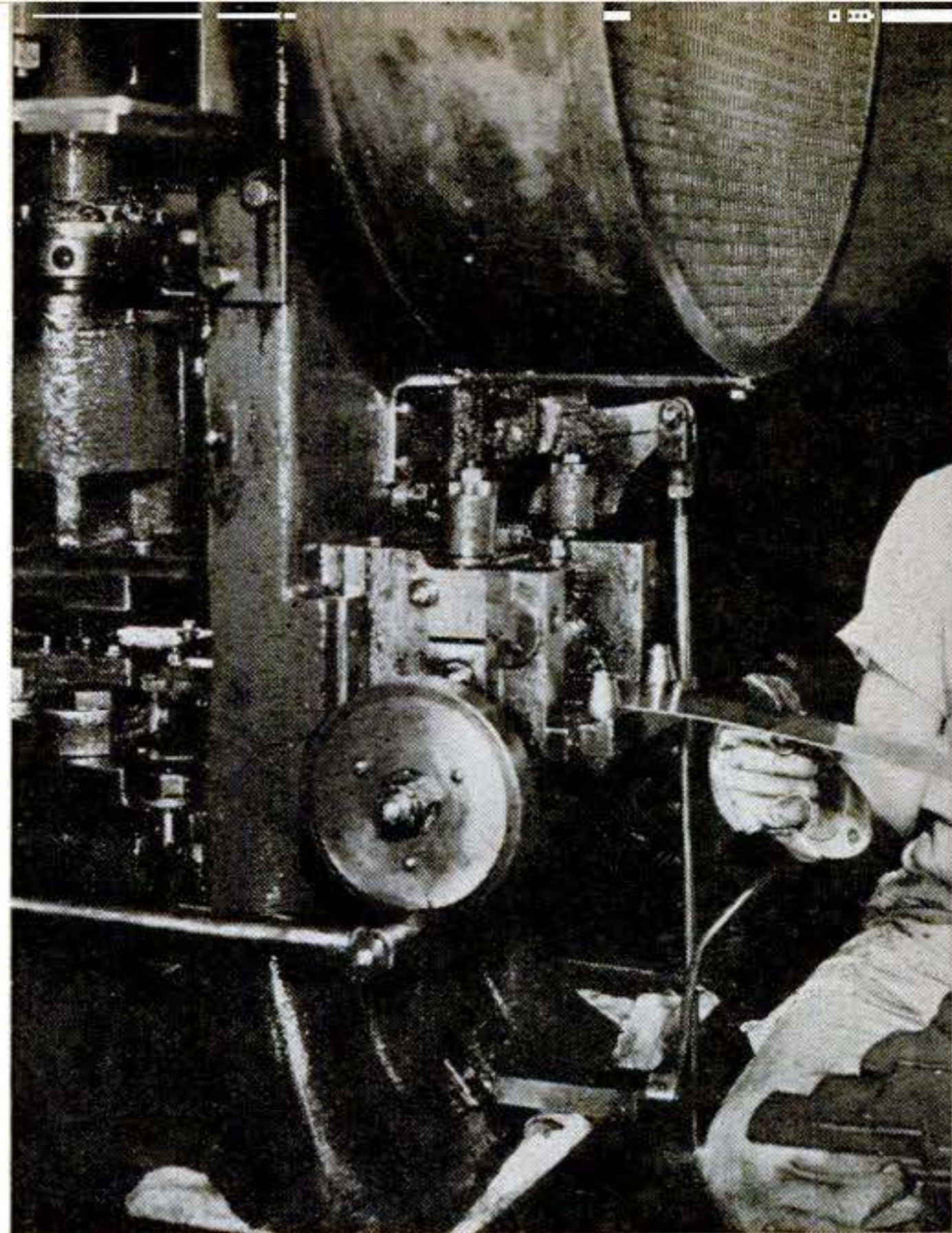

3. The strips of metal then are fed through a cutting machine that punches out coin blanks, two at a time. To insure maximum uniformity, grippers hold each strip rigidly in place as the cutters strike. There is no waste anywhere along the production line of Uncle Sam's mints. Scraps left over after cutting, called "clippings," are remelted and used later.



6. As a double check, time out is taken to weigh the blanks in these automatic scales. Although the blanks are weighed individually, one machine can handle 9,000 an hour. Standard weight for a quarter is 96.45 grains. With deft fingers the operator picks out any coin that varies by more than three grains. These rejects are put in a box on top of the machine.

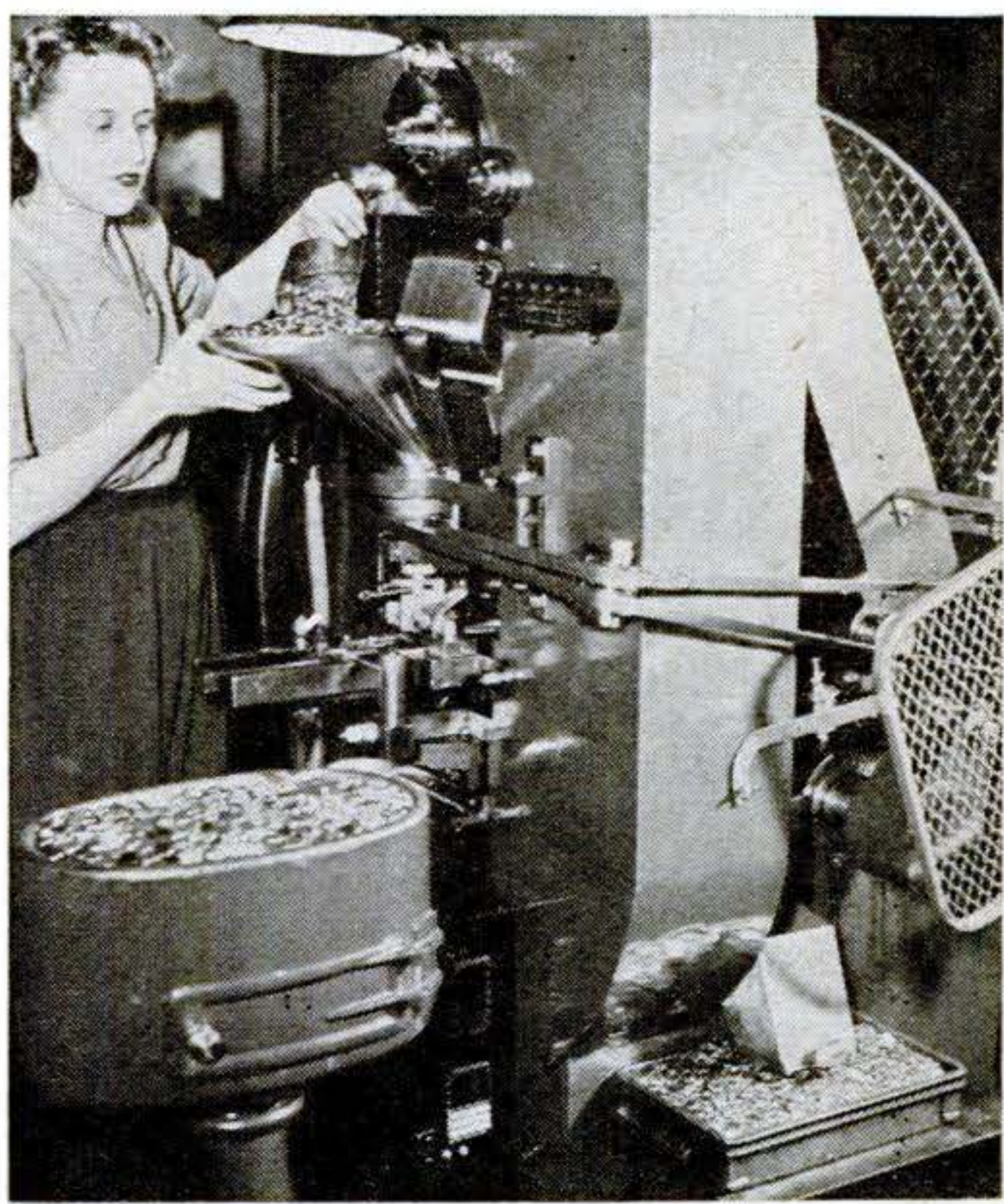

7. Here come the quarters—finished coins at last. The press shown here gulps blanks through opening at upper left and ejects its two-bit product into box at right foreground. Eighty tons of pressure squeeze the blanks between steel dies to make the head and tail designs; at the same time a collar puts reeding around the edge. Capacity is 100 coins a minute.

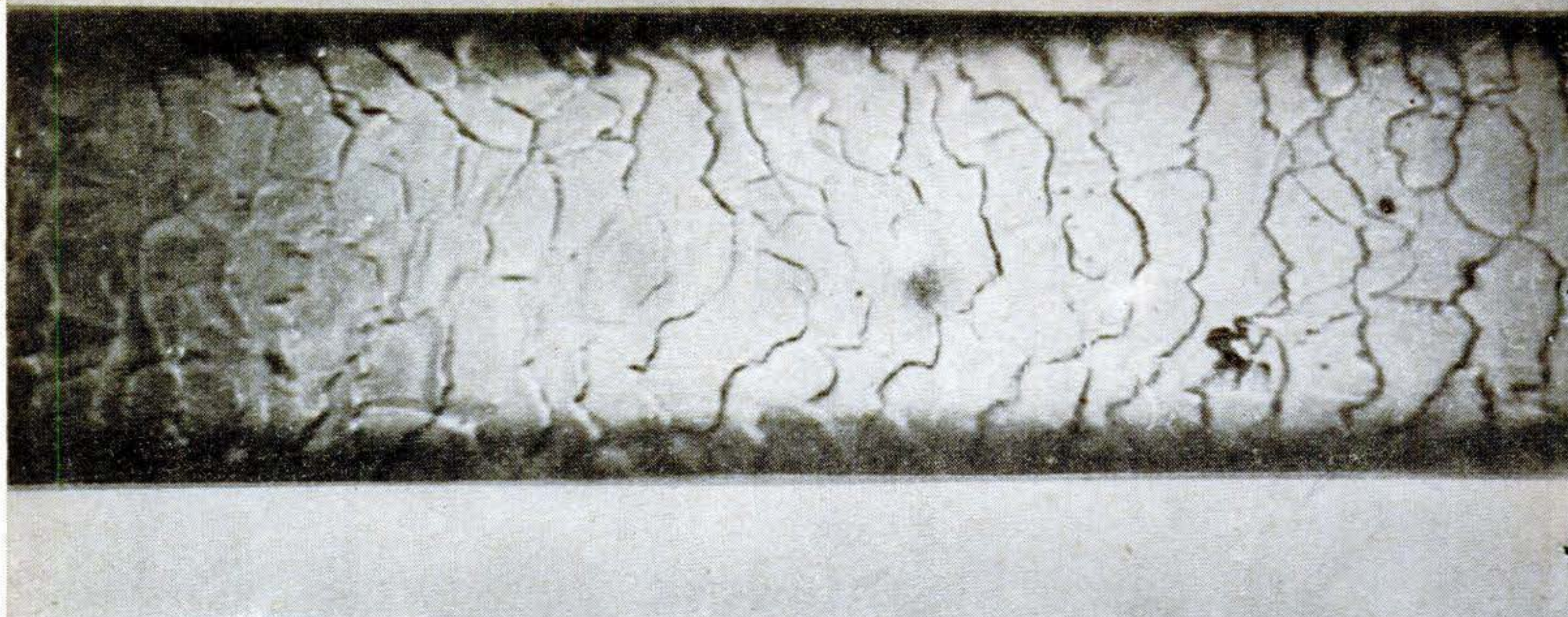

Important clues in hair identification are the scales, shown above magnified 500 diameters. These are of the "shingle" type; others are

found completely encircling the shaft. Authorities recognize that human beings have as many as eight varieties of hair scales.

Catching Criminals By a Hair

How laboratory research "fingerprints" human hair as an aid to scientific identification.

By Andrew R. Boone

A DEFENDANT was on trial for assault. The jury was in doubt when Dr. Paul L. Kirk, of the University of California's crime laboratory, showed them a pair of similar hairs wound around a glass bobbin. One hair was found on the scene of the crime; the other taken from the accused.

"I can't prove that these two hairs are from the same head," said Dr. Kirk. But then he went on and demonstrated point after point of identity between the two strands.

The verdict was "guilty."

This was not the first time that the scien-

tific study of human hair has helped bring the guilty to justice or clear those falsely accused. Dr. Kirk, a professor of biochemistry, began his study of hair some 20 years ago. Since that time he has worked in his laboratory on more than 150 cases, representing crimes ranging from petty larceny to murder. And although Dr. Kirk is the first to admit that hair is not yet a positive means of identification, his courtroom testimony never has been discredited.

To describe a hair scientifically you must look inside it, and study its structure—particularly when a man's liberty or life is at stake. A good head of hair contains about 130,000 strands. They assume many shapes, the majority being oval in form.

Their structure is complex. A hair is divided into three parts: scale, cortex, and medulla. The scales appear as tiny shingles, several hundred to the inch. The cortex, immediately under the surface scales, is composed of a group of tiny elongated fibrils. The medulla (not always present), is a pithy core of cells interspersed with diffused pigment, pigment cells, and air spaces, lying along the central part of the shaft.

And to confuse the hair detective, the hairs on the crown of a man's head are not the same as those on the nape of his neck. A permanent wave can result in two spots of a single hair being different in both appearance and composition. Dyeing alters surface hair color but not internal-pigment color, while bleaching does both.

Refractive index (the ability to slow up

HOW MICROSCOPIC COMPARISON MATCHES UP HUMAN HAIRS

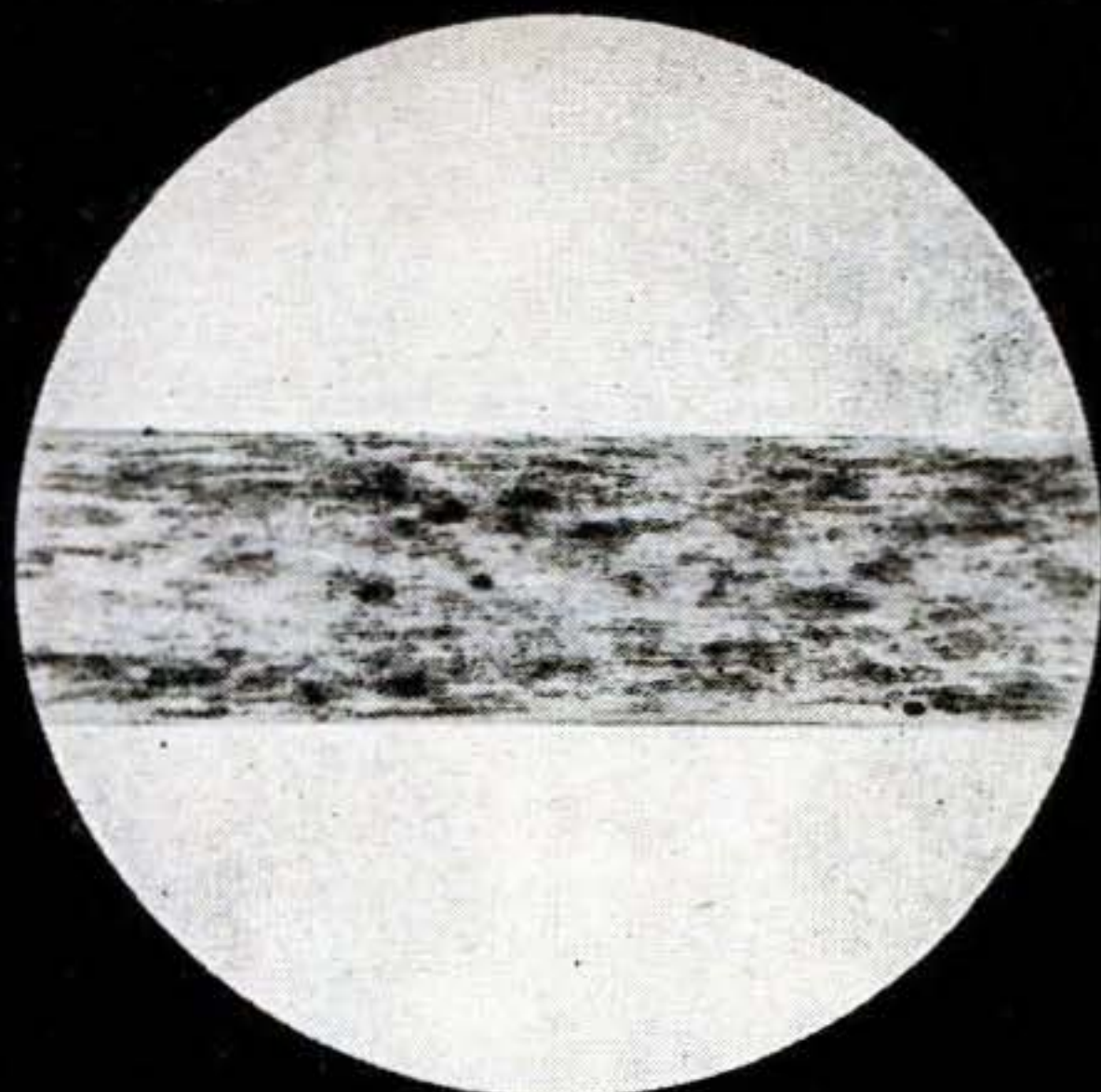

A HAIR TELLS ITS STORY. The strand, left above, taken from an axe used in murdering a brown-haired woman, reveals a granulated pigmentation.

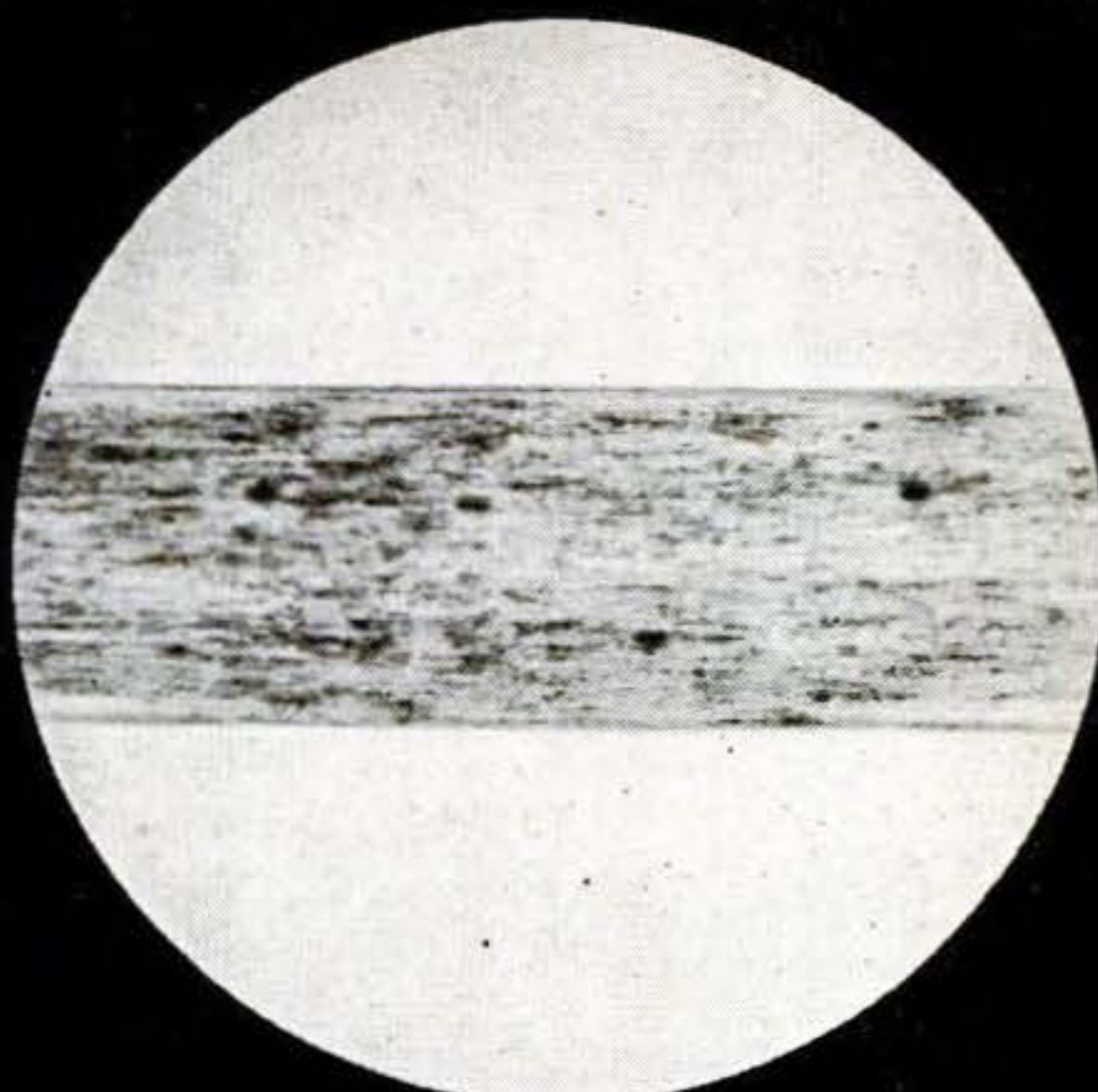

Note how closely pigment of specimen, right above, taken from victim's head, matches sample at left. An important step has been made in matching the hairs.

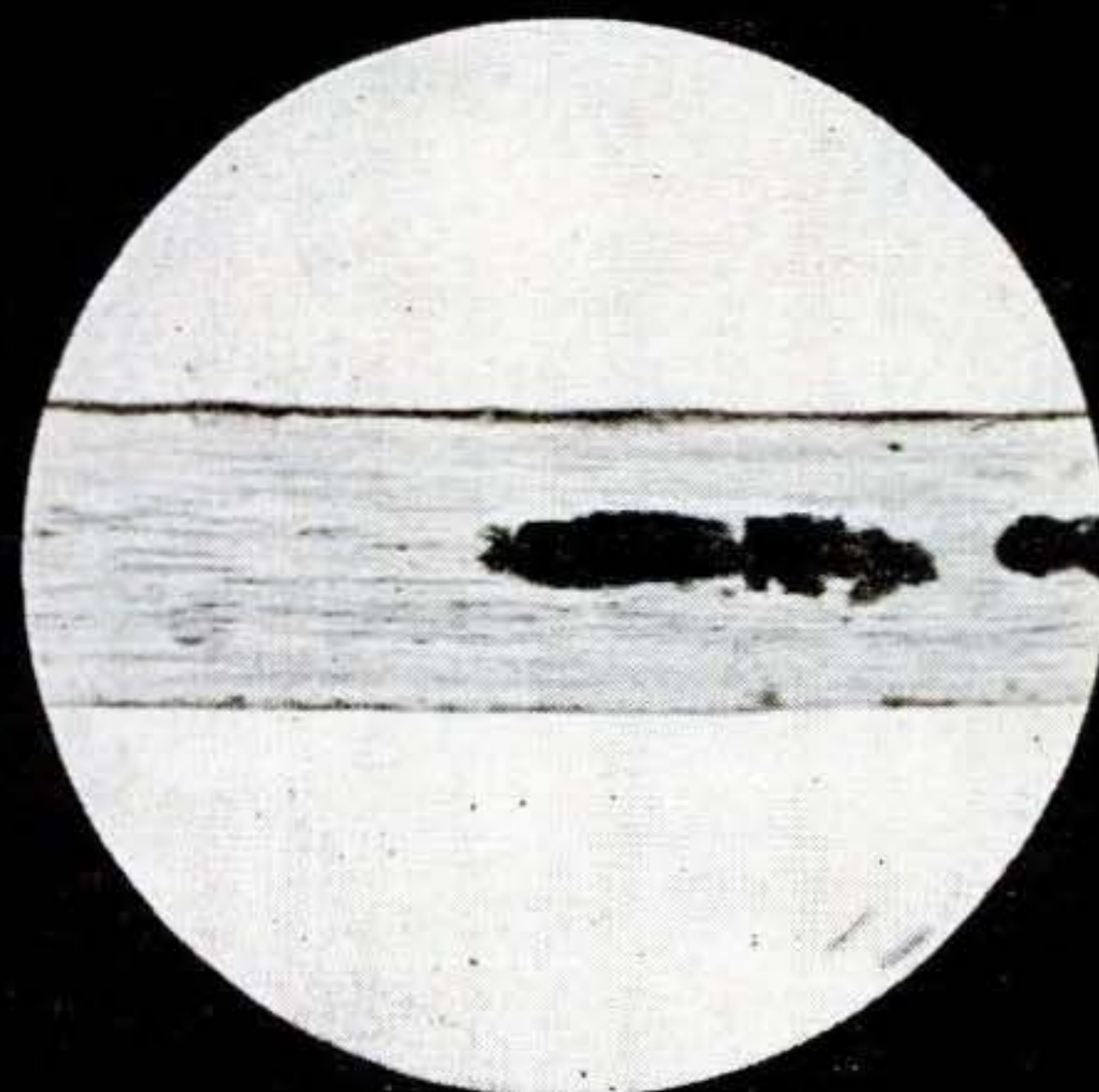

AXE YIELDS ANOTHER CLUE. Further examination of specimen, left above, from death weapon reveals fragmental medullary material, the pithy core

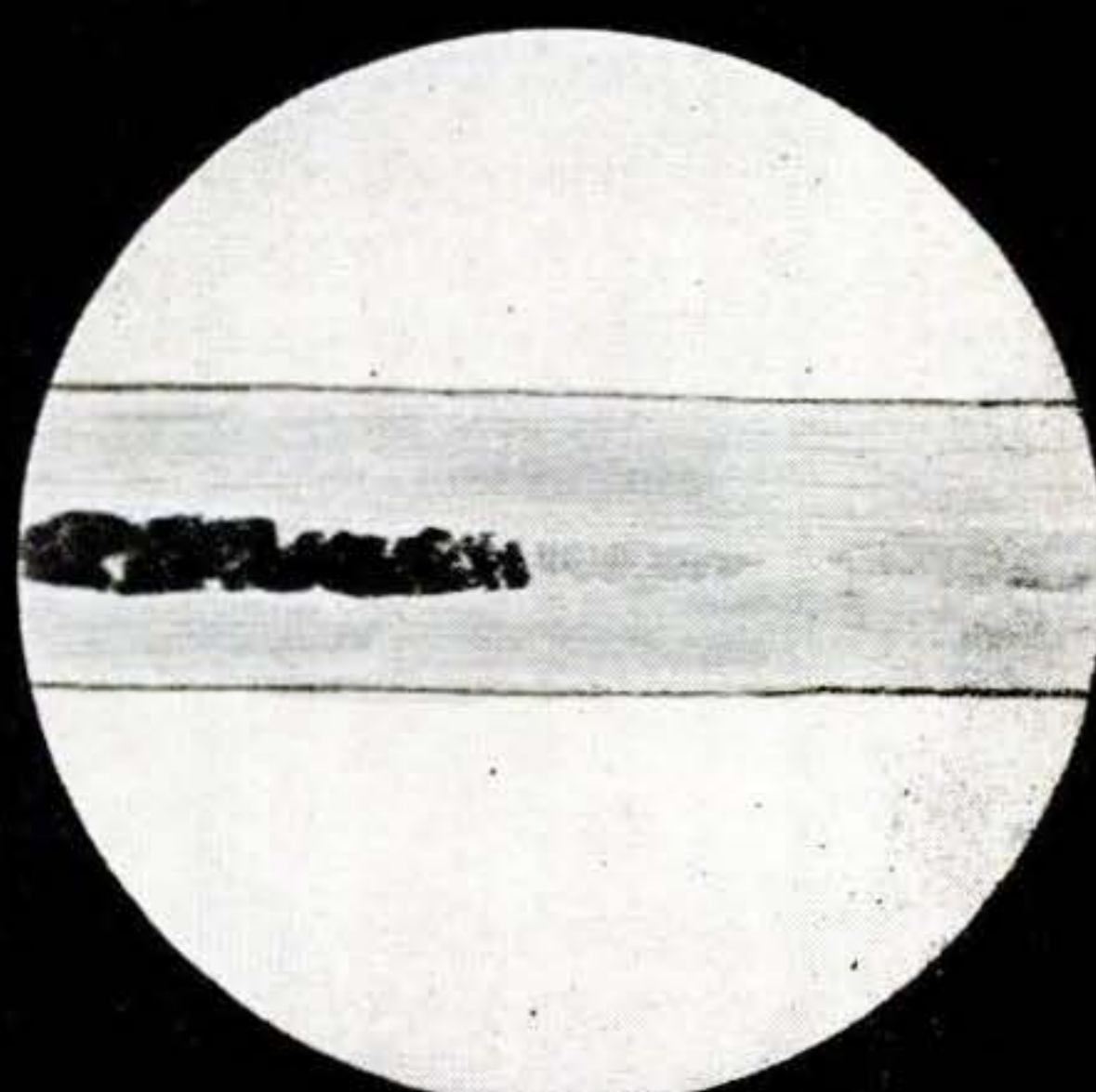

found in some head hair. Strand of the woman's hair shown right above has same type of medulla, forging another link in the chain of scientific evidence.

EVIDENCE PILES UP. When microscope is trained on cast of hair taken from axe, left below, its scale pattern stands out. Examination of victim's hair,

right below, shows it checkered by same wavy, shinglelike scales. Although not conclusive, these points of hair identity helped convict a murderer.

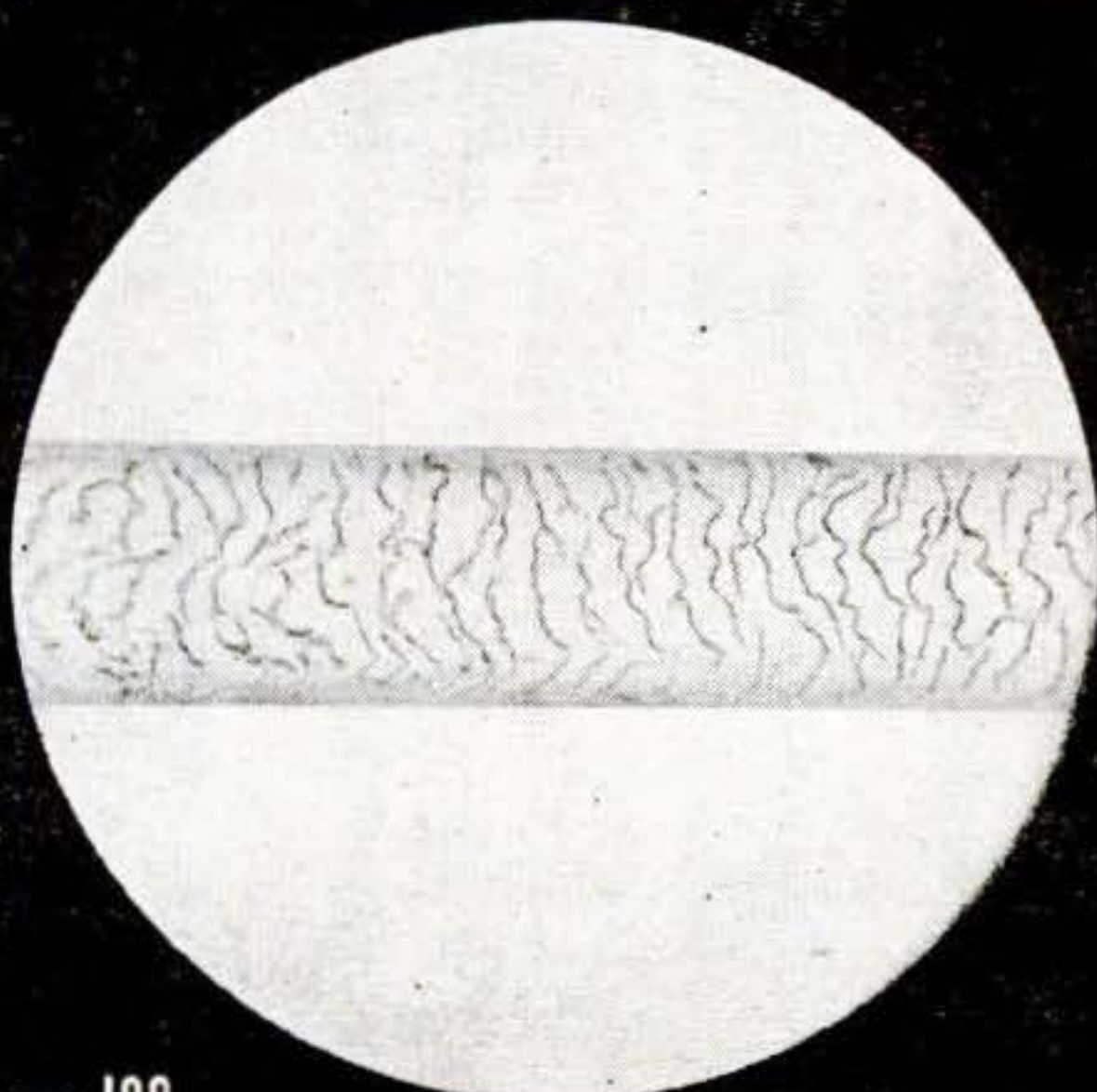
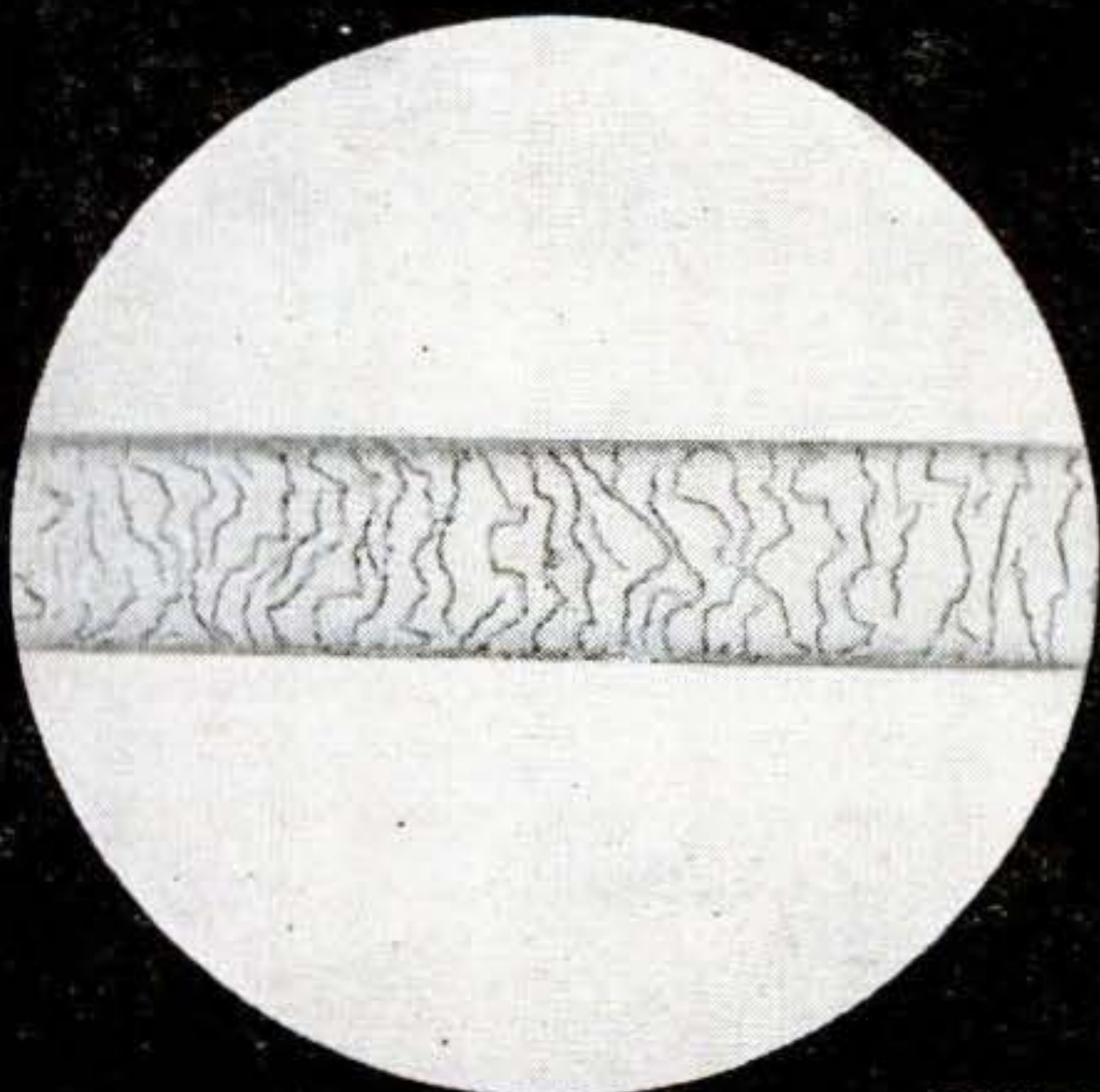

light passed through it) averages higher in women's hair than in men's, which helps the hair sleuth. Knowing the subject's race, Kirk can examine a hair, and four out of five times tell if it comes from a man or a woman.

Identifying the guilty and absolving the innocent by means of hair, however, is not yet a job for the cops. A vast store of knowledge must first be acquired by investigators such as Kirk. Comprehensive files including nearly all types of human hair must be built up and made available for study.

Kirk has already filed 100 hairs each from 400 people, mostly willing students at the University of California, covering all parts of their bodies. He plans to obtain samples from some of them over a period of 20 years to study changes that develop with age.

Although scores of factors enter into the hair identification picture, Dr. Kirk depends largely on the following major points to prove his cases:

Color. This is the first and most obvious, and in many cases can quickly eliminate



1. Searching for telltale hairs, Dr. Kirk goes over a bedspread with a special vacuum attachment. Hairs will be caught on a porous disk through which air but not dirt can pass.

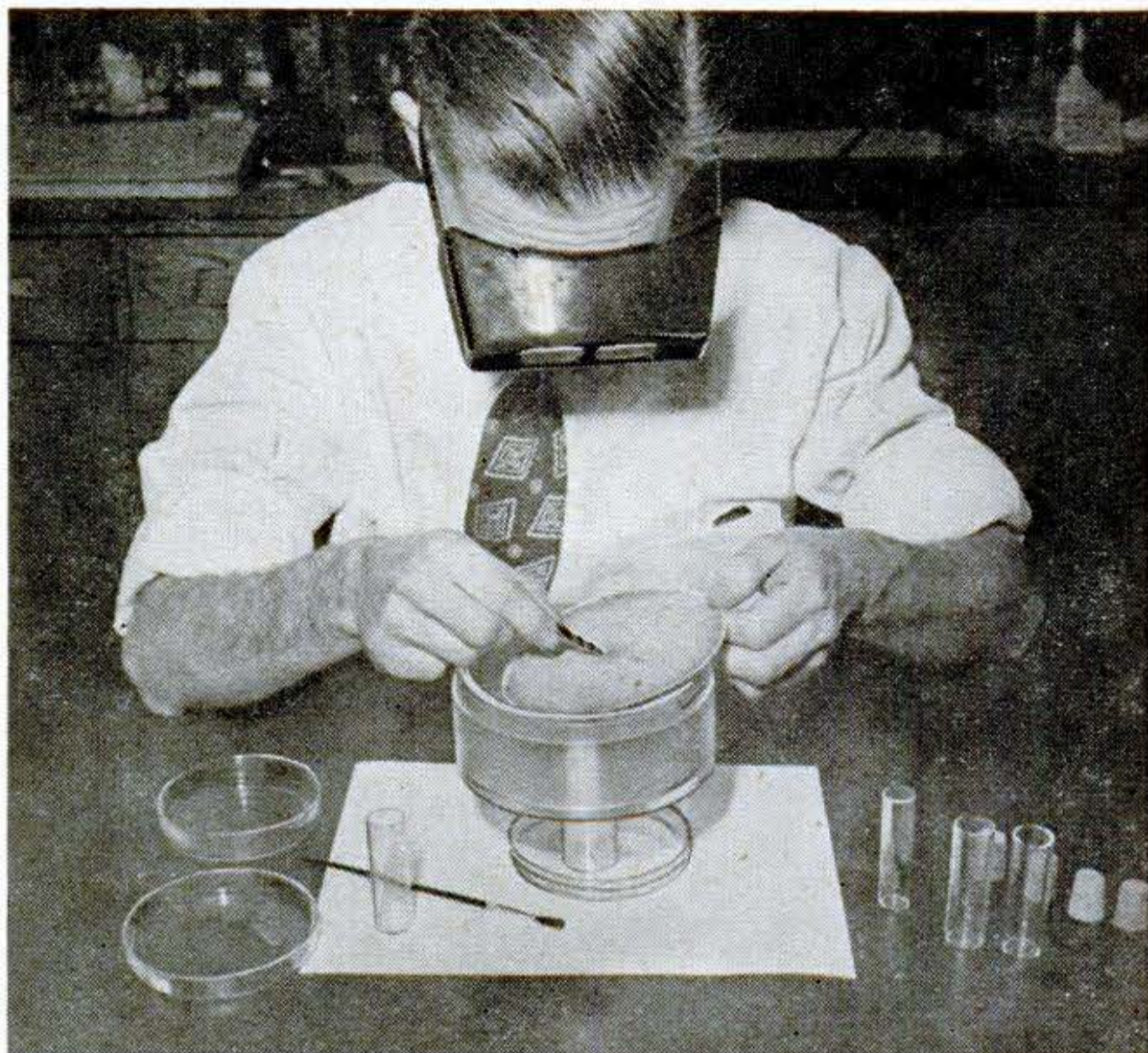

2. The dirt and hair collected is then examined through a low-power enlarging lens. The hairs are carefully removed with tweezers and prepared for microscopic and other studies.

4. After drying, short hairs are then cut into pieces one millimeter long for mounting on slides. Two ordinary razor blades, set parallel on a thin brass block, do the job efficiently.

5. Hairs of different density will be separated when immersed in a mixture of two liquids of different specific gravity. Here Dr. Kirk is taking a density reading off a test tube.

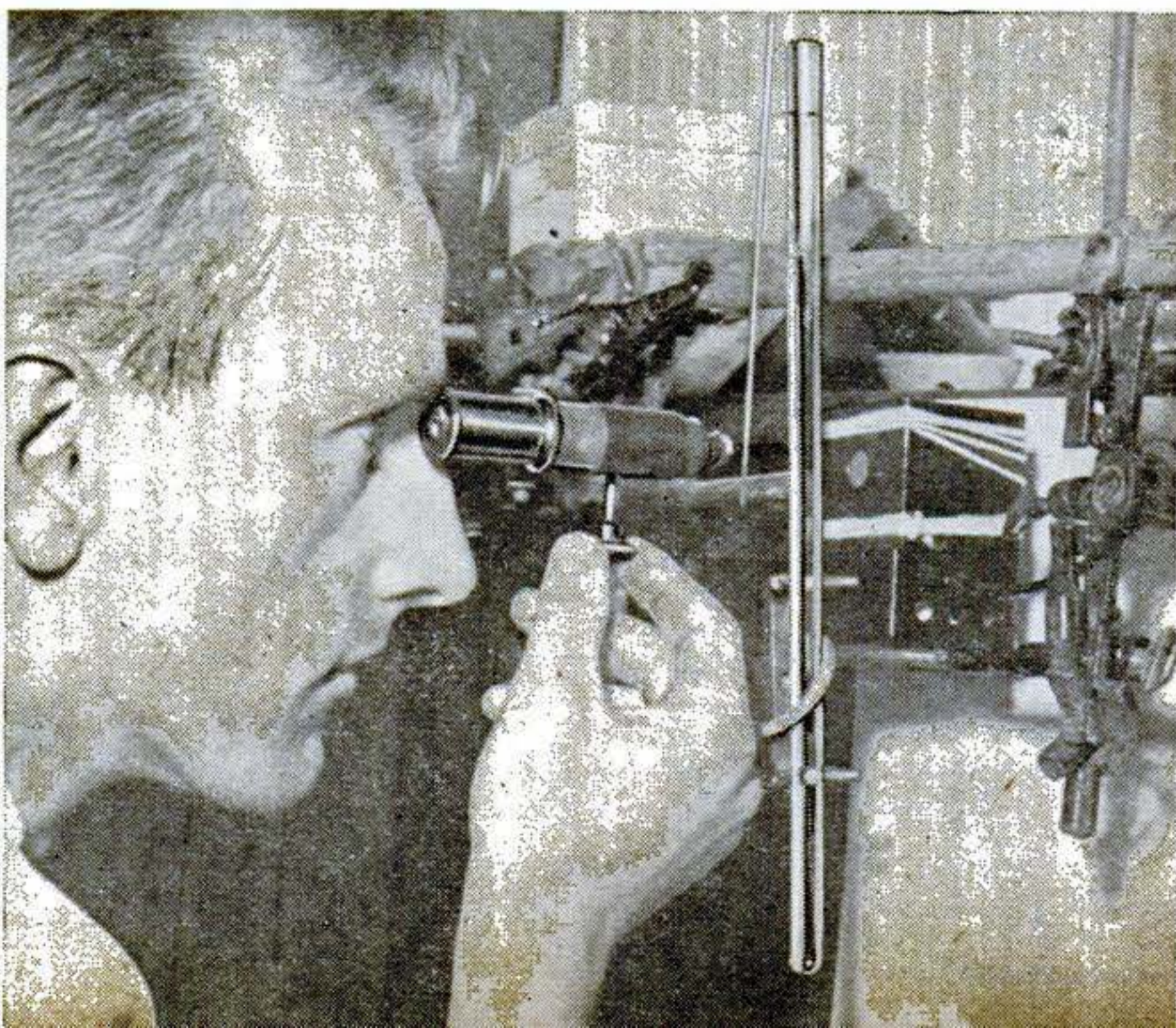
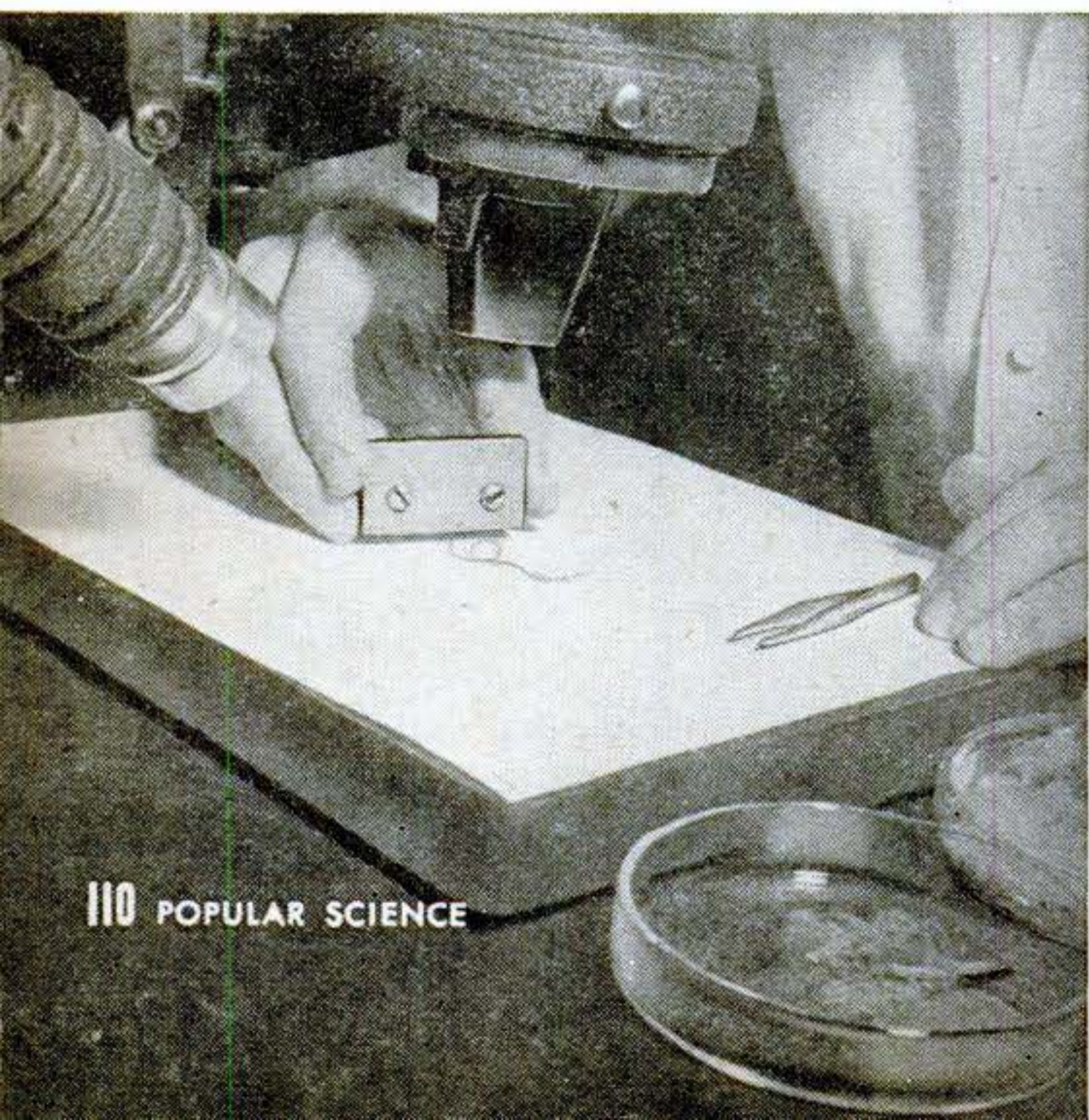

suspicion from a person. But color must be interpreted with caution, for shades of hair vary widely on a single head, such as from blonde to brown on a red head. Kirk hopes that an absolute color chart for hair may be worked out, and that the chemical identity or differences of pigments may be established as a check on color.

Diameter. Before assigning any great significance to the fineness or coarseness of an individual hair, accurate measurements of the maximum diameter is taken with

a calibrated ocular micrometer, and of the minimum diameter with a calibrated fine adjustment on a microscope.

Scale Count. Scores of counts must be taken along one or several hairs to obtain an average. If the average count on your hair, for instance, is 24 scales for each two-tenths of a millimeter of length, all hair averaging less than 22 or more than 26 would be considered as coming from someone else.

Scale Picture. This means the shape, regularity or irregularity of sizes, edges, and any other features revealed through the microscope. Generally, hair scales of one head follow the same general pattern, and hairs have been identified on this basis alone.

Pigment. This is one of the best points of evidence in the identification of hair. Both density and distribution play a part. "In general," Kirk says, "the pigment density is inversely proportional to the amount of light that can be transmitted through the hair." Very light blonde or gray hair is of minimum density. Distribution of pigment granules is also important.

Medullation. The presence or absence of a pithy core (medulla) in hair is not considered of great significance. However, since some people have much medulla in their hair, and others little or none, its study is sometimes of value.

Refractive Index. The varying ability of hair to slow up light serves both in matching hairs and in determining race and sex.

Double Refraction. All hair is capable of this optical phenomenon to some degree. When two hairs of the same diameter are examined with polarized light, however, those from the same source usually show the same interference colors; those of different origins, different colors.

Density. The specific gravity of hair often differs among individuals, ranging from 1.30 to 1.39. It will also differ between medullated and nonmedullated hair of the same person.

Other factors may prove of consequence, such as tensile strength, stretch coefficient, and electrical characteristics. Permanent-waved hair, for instance, stretches readily as compared to untreated hair. Perhaps hair of one individual will stretch farther than hair of another. So far, little investigation has been done along these lines.

Someday, Dr. Kirk believes, further research by physicists and chemists may make hair the equal of fingerprints as a means of positive identification.

END

DECEMBER 1947 III

3. A microscope is needed to detect some fine hairs among the debris of dandruff, oil, and dust. Once isolated, the hairs are washed in a mixture of equal parts of ether and alcohol.

6. Enlarged photographs, some as high as 500 diameters, are used for further study and courtroom presentation. Dr. Kirk uses small camera, placed lens down on horizontal mount.

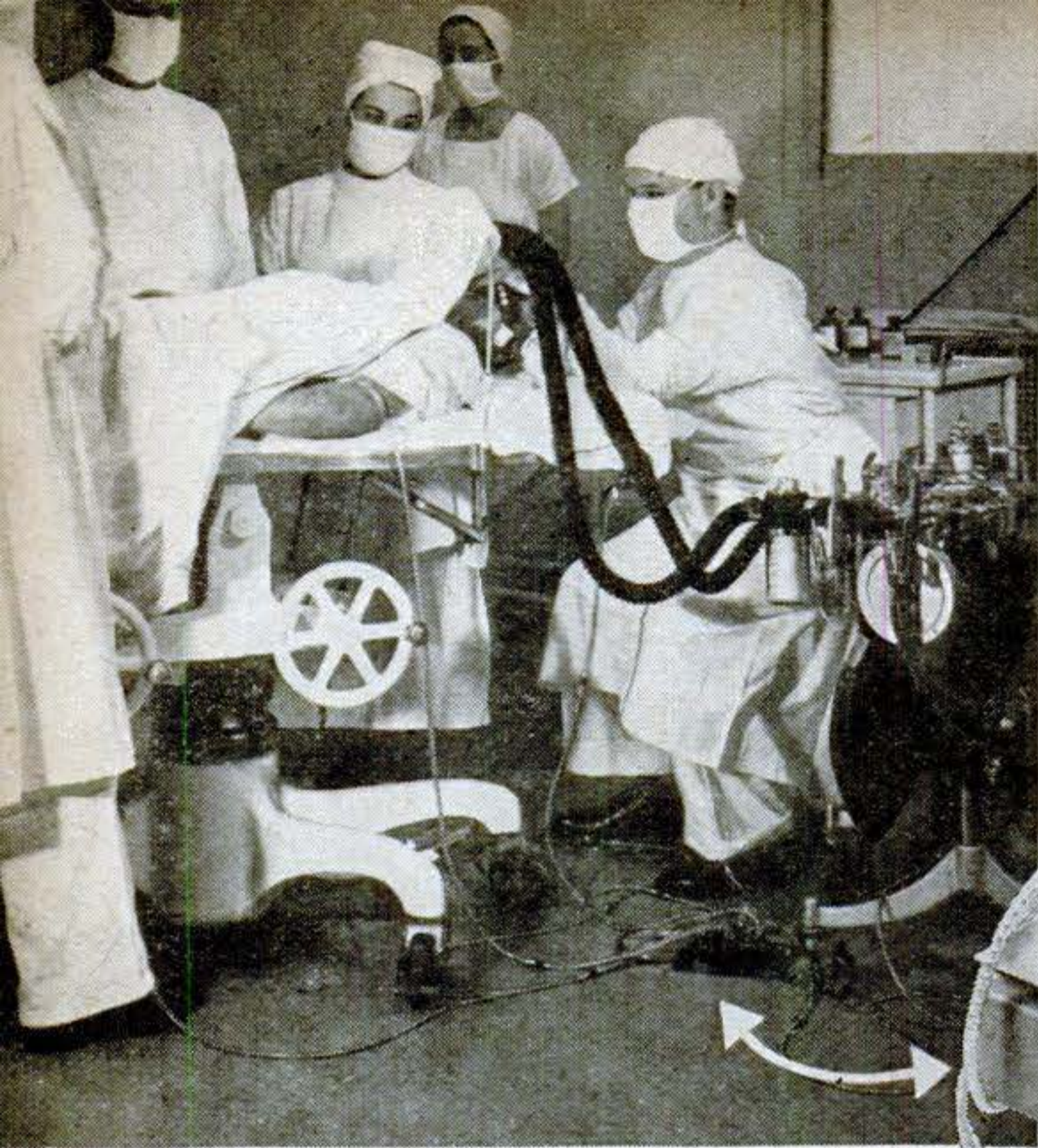

Installation of new grounding system is shown in picture above. Arrows indicate where device is set into the floor.

Operating in Safety

A NEW grounding device has been developed for use in hospital operating rooms to guard against explosions caused by static electricity touching off the highly volatile anesthetic gases.

Heart of the device is a bronze box (shown in inset) that is set flush in the floor and grounded to the nearest water pipe. In the center, six socket receptacles receive the jack-plug ends of bead chains covered with plastic insulation. At other ends of the chains are clamps for attachment to objects such as anesthesia machine, operating and instrument tables, nurses, and patient.

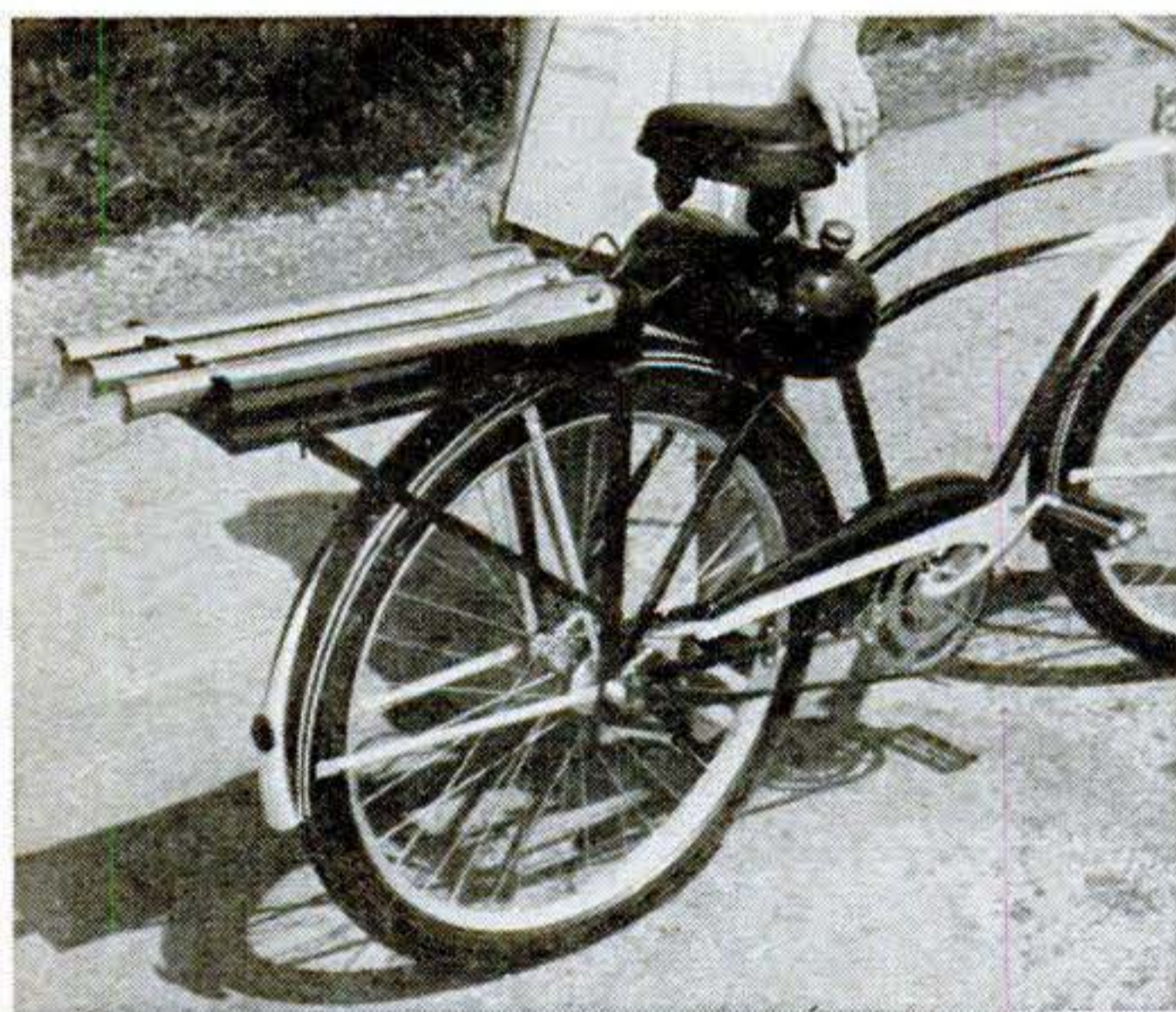
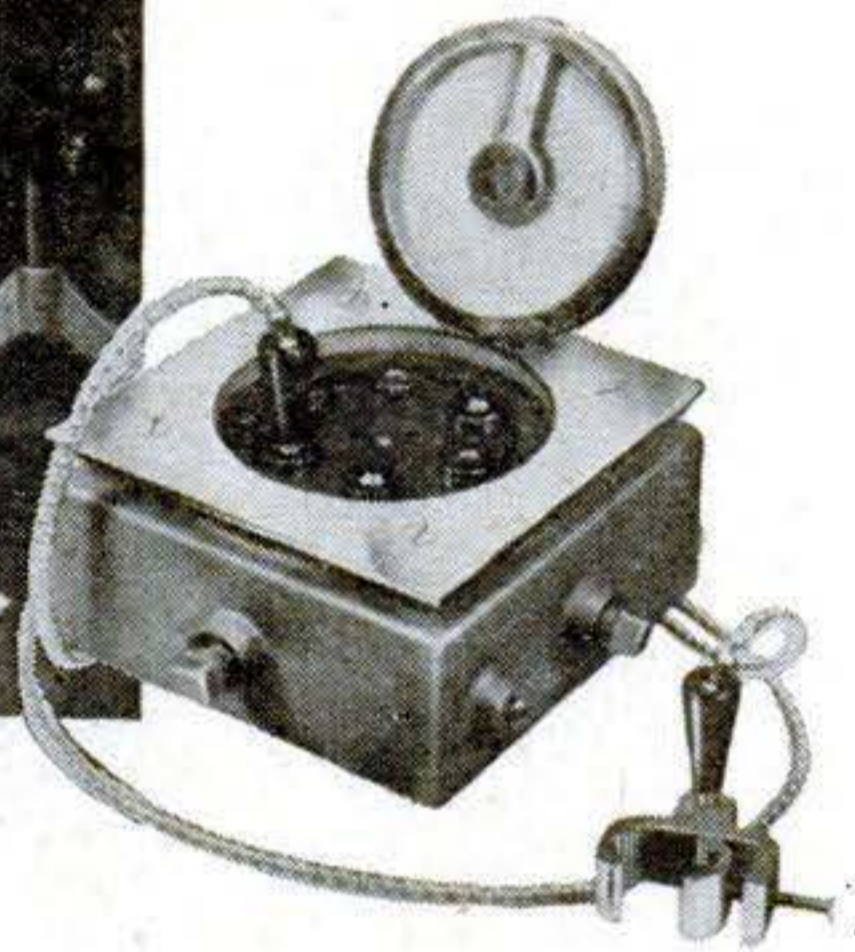

Jet Propels Bicycle

SOUNDING off like a squadron of fighter planes, this jet-powered bike can make 25 miles an hour—but not for long, because of rapid fuel consumption. The three power units shown are miniature, gasoline-operated jet engines used for powering model aircraft and racing cars. This jet bike was made for exhibition purposes by the Aeromarine Co., of Vandalia, Ohio, but has not been produced commercially.

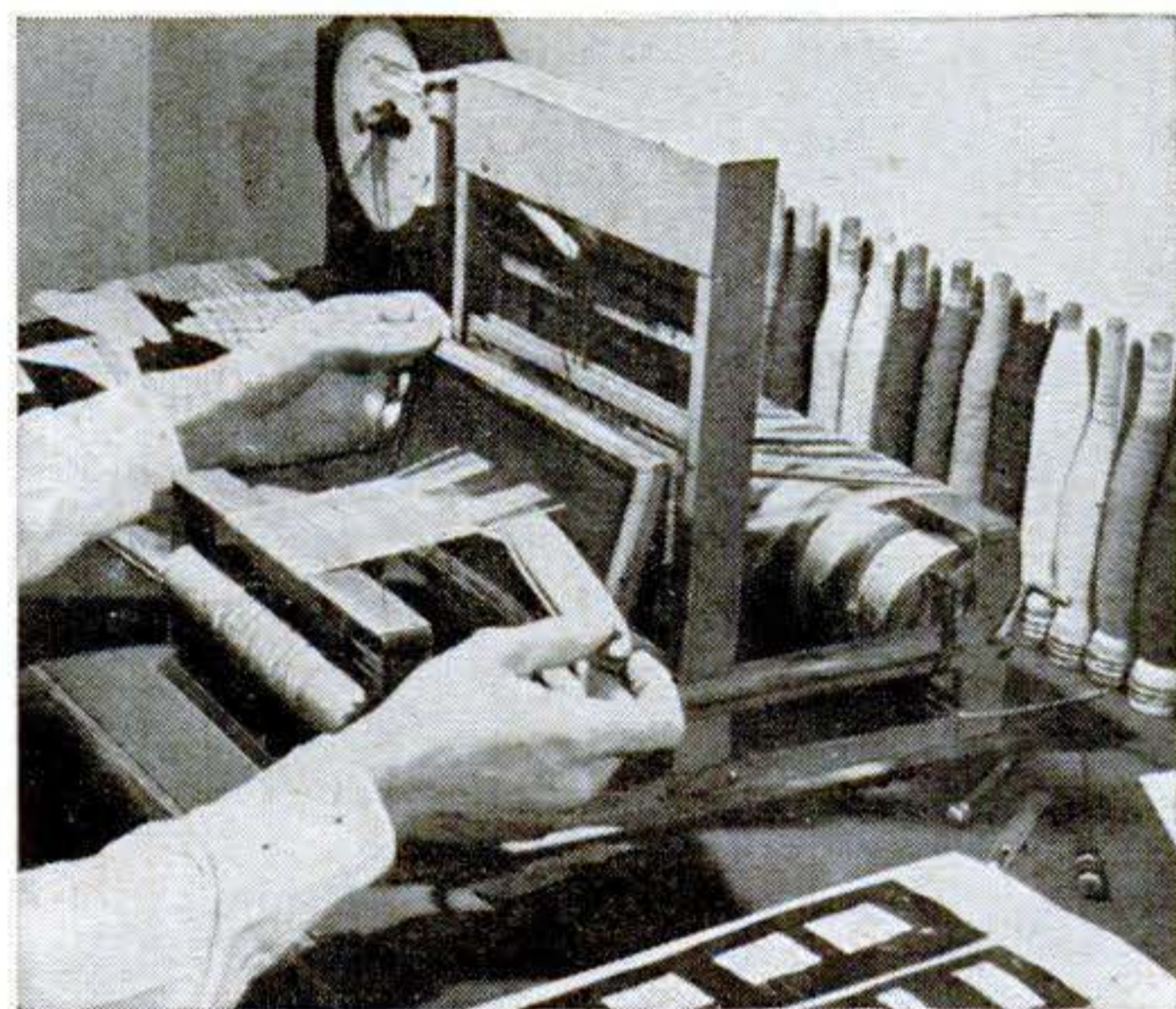

Tiny Loom Does Fast Job

THIS typewriter-size rayon hand loom makes samples of new fabrics in a few hours that would take weeks if woven at a mill. It is operated by Mooresville Mills, of New York City, to whom manufacturers bring ideas for new patterns and designs. The guide-woven sample can be tried out in the trade before the design goes into production. These samples are credited with selling 10 million yards of goods.

This Month's Pin-up

CONSOLIDATED'S slim XB-46, developed for the Air Force, has a speed of more than 480 m.p.h. It is powered by four GE J-35

turbojets, two in each nacelle. Knife-thin wings have span of 113 feet; the fuselage is 106 feet long, holds 10 tons of bombs.



I'd like to see them make...

Cartoons by Syd Landi

Everybody has his own pet idea of some gadget he would like to see in general use. What is YOURS? *Popular Science Monthly* will pay \$5.00 for every such suggestion that it accepts for publication. Contributions cannot be acknowledged or returned.



Spigots for Stoves. To make it easier to add water to food as it cooks on the stove, Claire Caswell, of Austin, Tex., would like ranges equipped with flexible, fingertip-controlled hoses connected to a water supply.

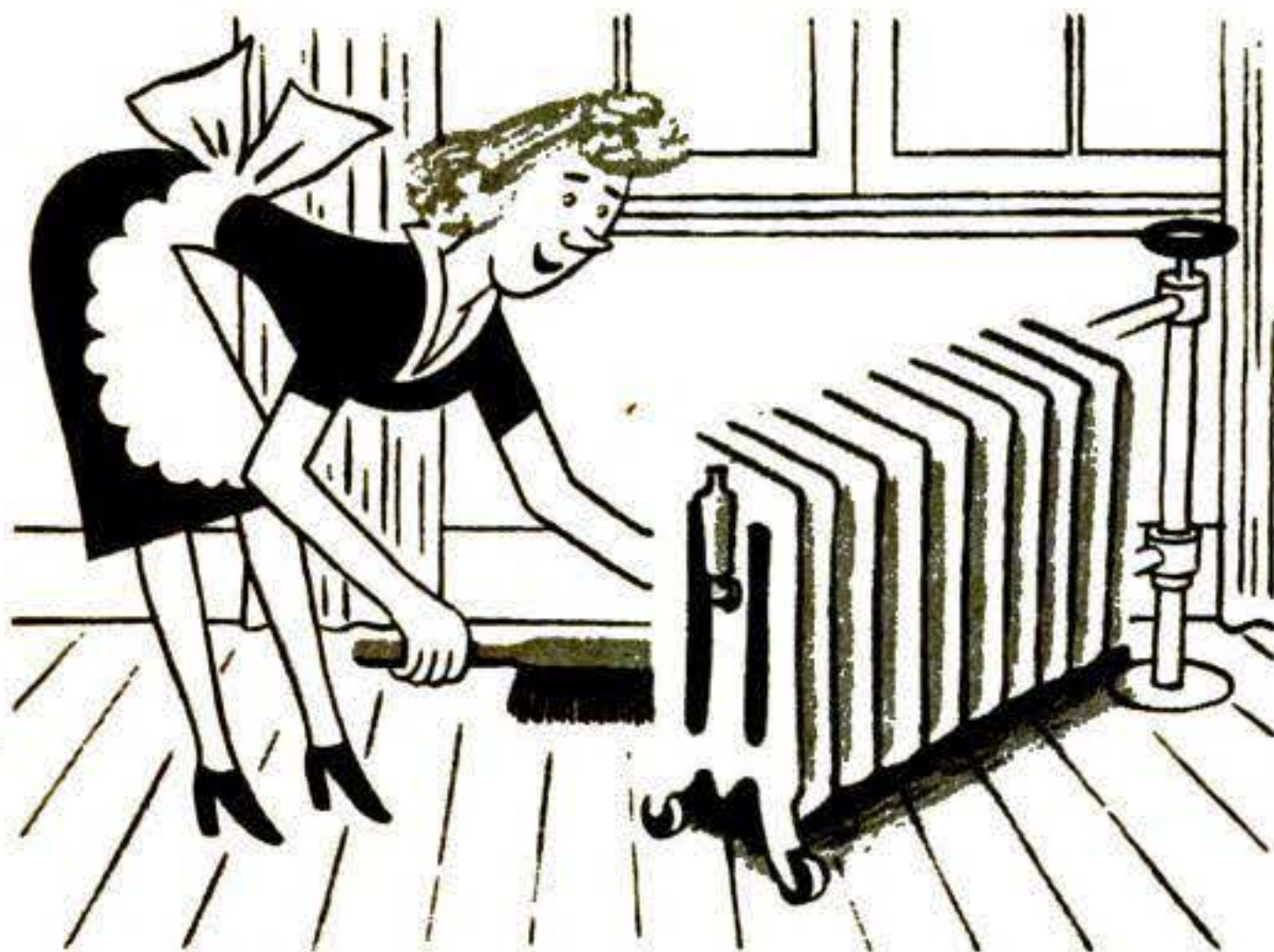

Swinging Radiators. Pivoted at one end and with wheels at the other, they could be swung out from the wall for easier cleaning, painting or papering, says Mrs. Madeleine Thompson, of Merchantville, N. J.



Shoppers' Aid. To let shoppers look at their leisure until ready to buy, Raymond Holtz, of San Francisco, suggests they be given tags saying "just looking" on one side and "ready to buy" on the other.



Self-Finding Keyhole. A funnel-like extension on the front-door keyhole would help guide key into the lock and put an end to fumbling in the dark, claims R. Pretorius, of Luderitz, South-West Africa.



Flouring Pin. A hollow rolling pin containing flour and dispensing it through tiny holes as it is turned would flour-dust the dough while rolling it at the same time, declares Cecile Ludolph, of Marshall, Tex.

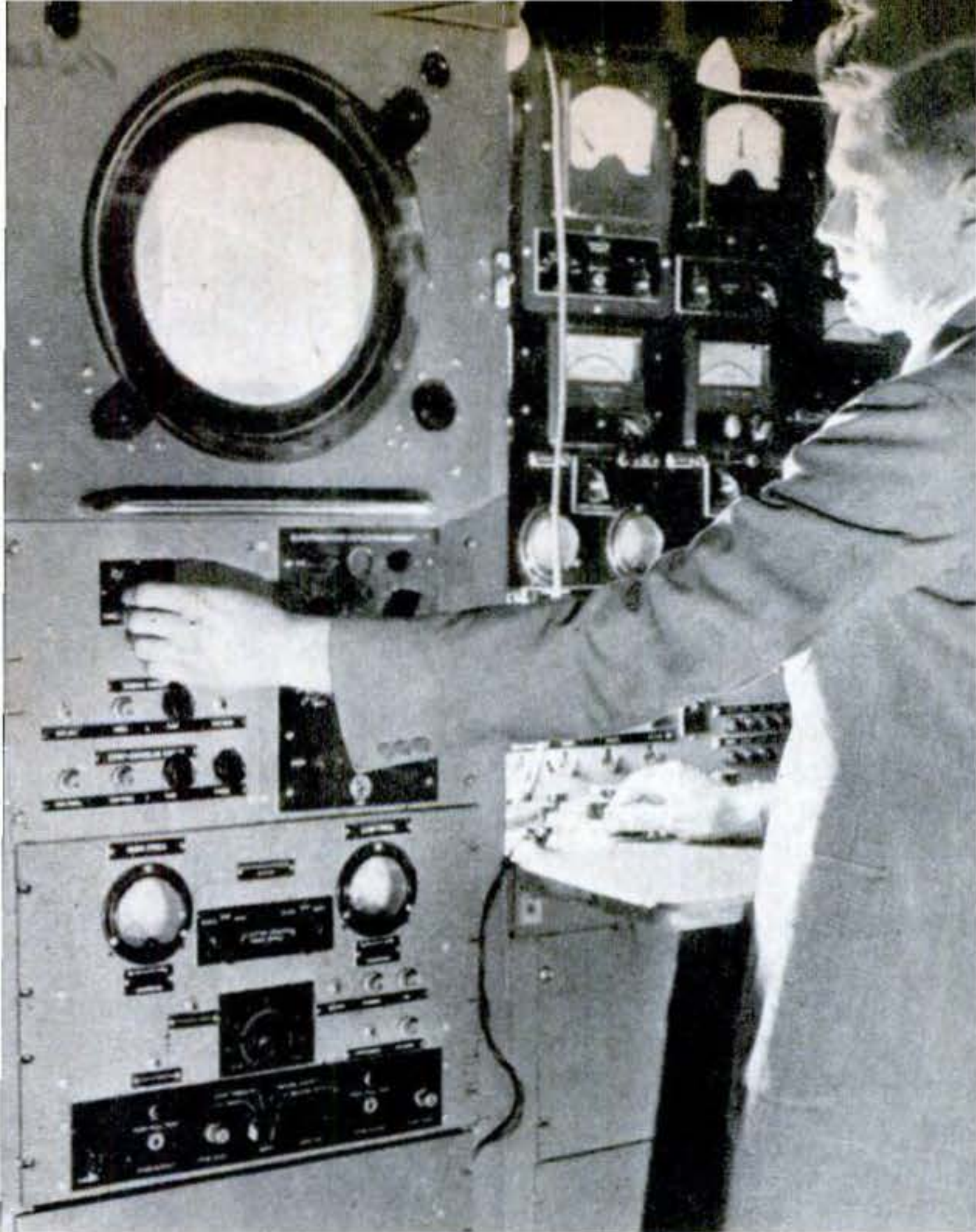

Twirling the dial of the television test set, above, creates an infinite variety of patterns for designers. Three examples are at right.

Even Necktie Designers Can Use Electrons

FABRIC designers in search of inspiration may well turn to a television receiver, General Electric engineers suggest.

When they test cathode-ray tubes for modern sets by applying varying voltages, the engineers have found that the flying electron beam often sketches traceries of striking beauty upon the luminescent viewing screen. Ranging from random squiggles to intricate geometrical lacework, the designs offer fascinating possibilities for dresses, scarves, ties and draperies.

Small, portable test sets, currently available, are suited to apply this new scientific aid to art. Simply by twirling a dial, a seeker after new patterns can conjure up an infinite variety. Through the magic of electronics, the marvelous symmetry of motions resulting from the complex interplay of natural forces becomes visible to human eyes. Captured by photography, as at right, the fleeting images may be preserved for subsequent transfer to fabric.

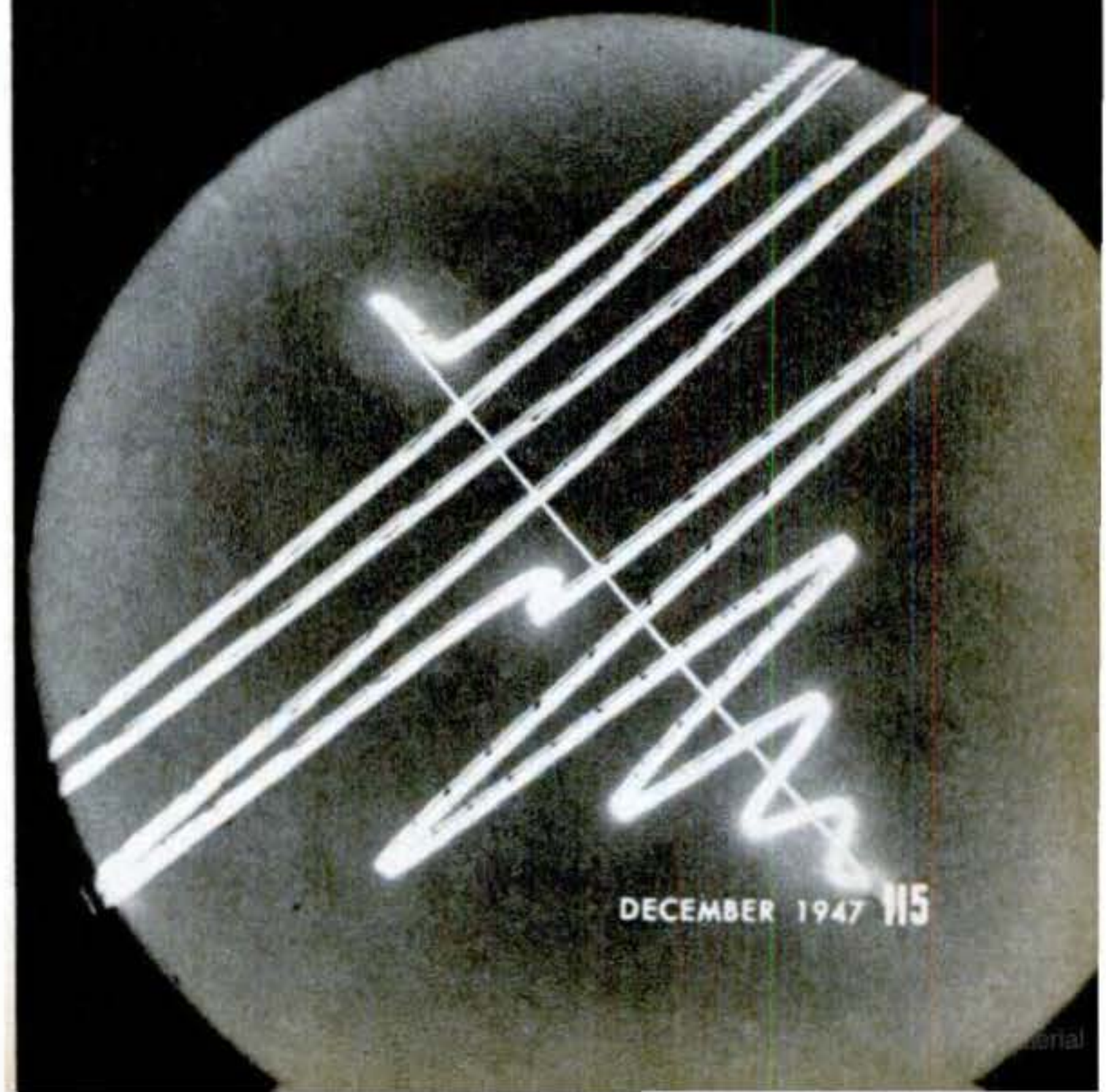
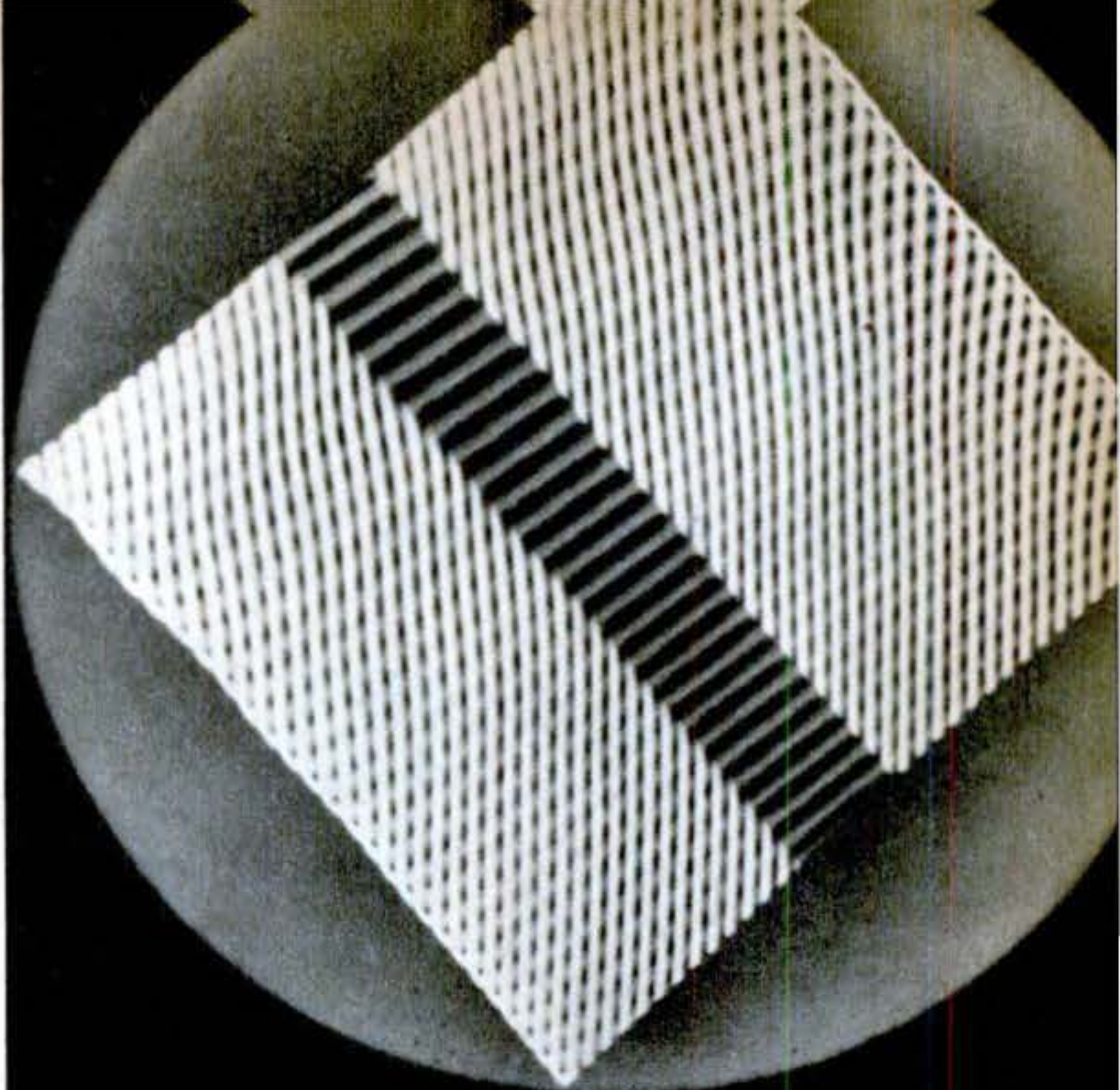

Turning a Watch Inside Out

HERE is how you can take a watch—or an aircraft engine—apart and put it together again without even a screwdriver. It's all done with transparent plastic, printer's ink—and painstaking techniques. Using them, the Trans-Vision process can turn a machine inside out for you and not lose a screw.

Here we see the process, developed by Milprint, Inc., applied to watches. Each page of this booklet, prepared for the Bulova School of Watchmaking, has drawings of one layer of a watch. Every time you turn a page, you peel off a layer, like a layer of an onion.

At left is shown the complete watch, enclosed in its case, as it appears through the transparent opening of the cover. Lift the cover and you lift off the upper case. As each page is turned, the underside of the section removed can be seen on the left-hand page, the top of the next layer on the right. Thus, while the watch is taken apart on the right side, it is put together again on the left.

Printing and binding one of these booklets is an exacting job. Each picture must be printed, by rotogravure, on the back of the sheet, so that the ink is protected by the transparent paper. Pictures of the top and bottom of a layer of mechanism are printed on one sheet, which is then folded to bring the two back to back. Not only must they match, but each page must be in perfect alignment with every other page or the effect is lost.

Below, the pages are turned for you—and a watch comes apart in your hands.

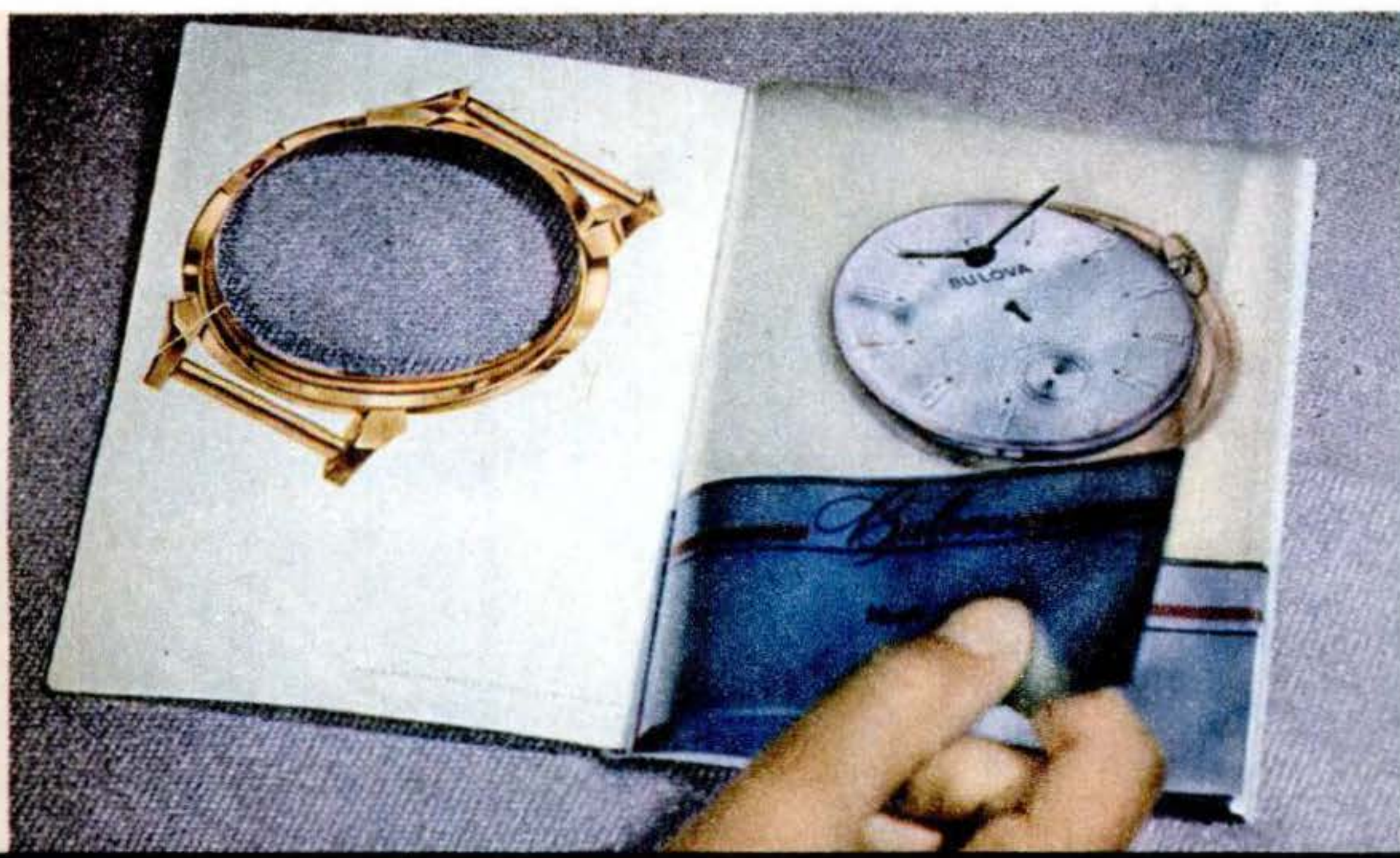
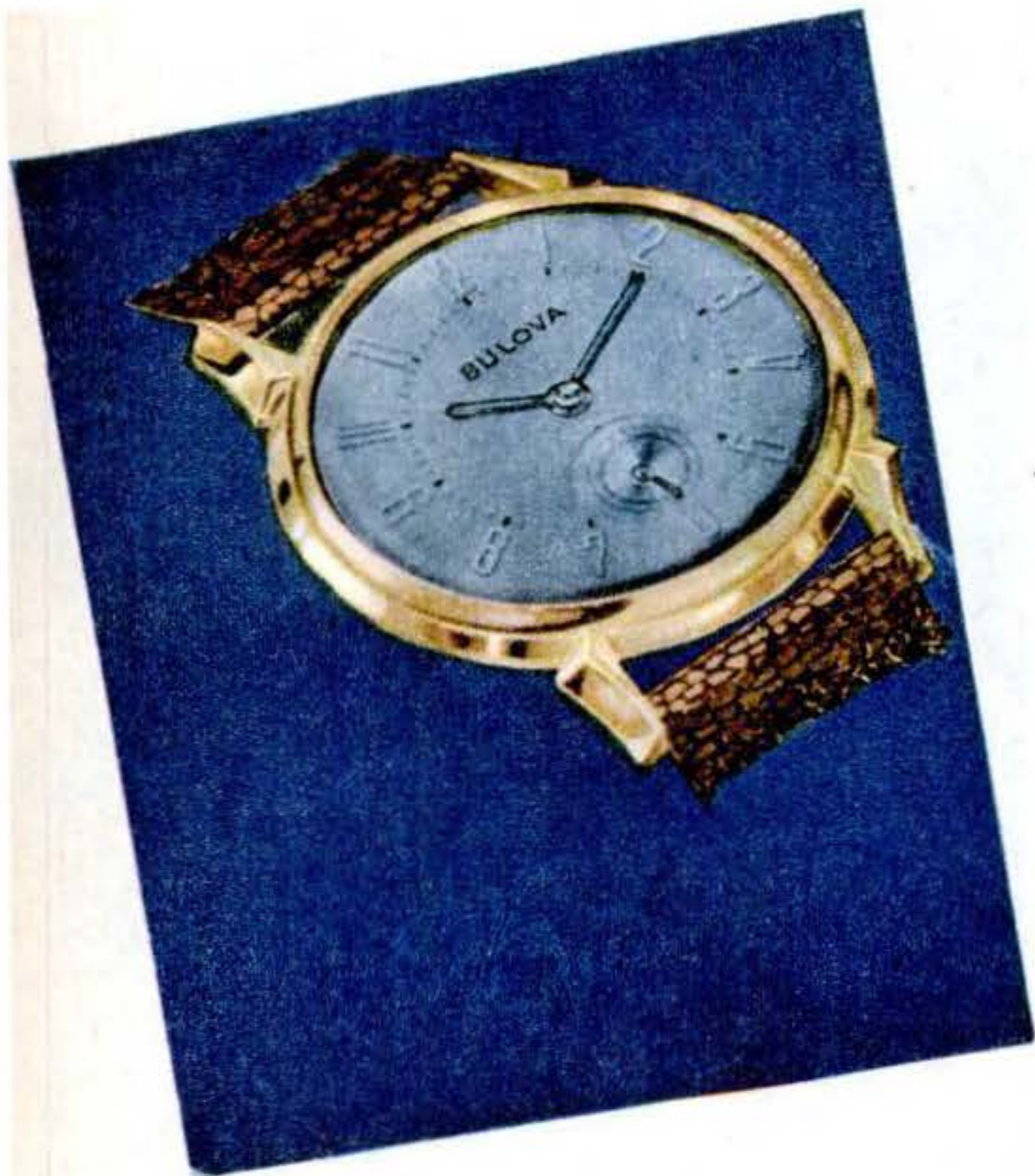

1 Opening the cover has already removed the upper half of the case: now the hour and minute hands are lifted off as you turn the first page, leaving the dial exposed on the next sheet. When all details have been carefully noted, the page is turned and the underside studied.

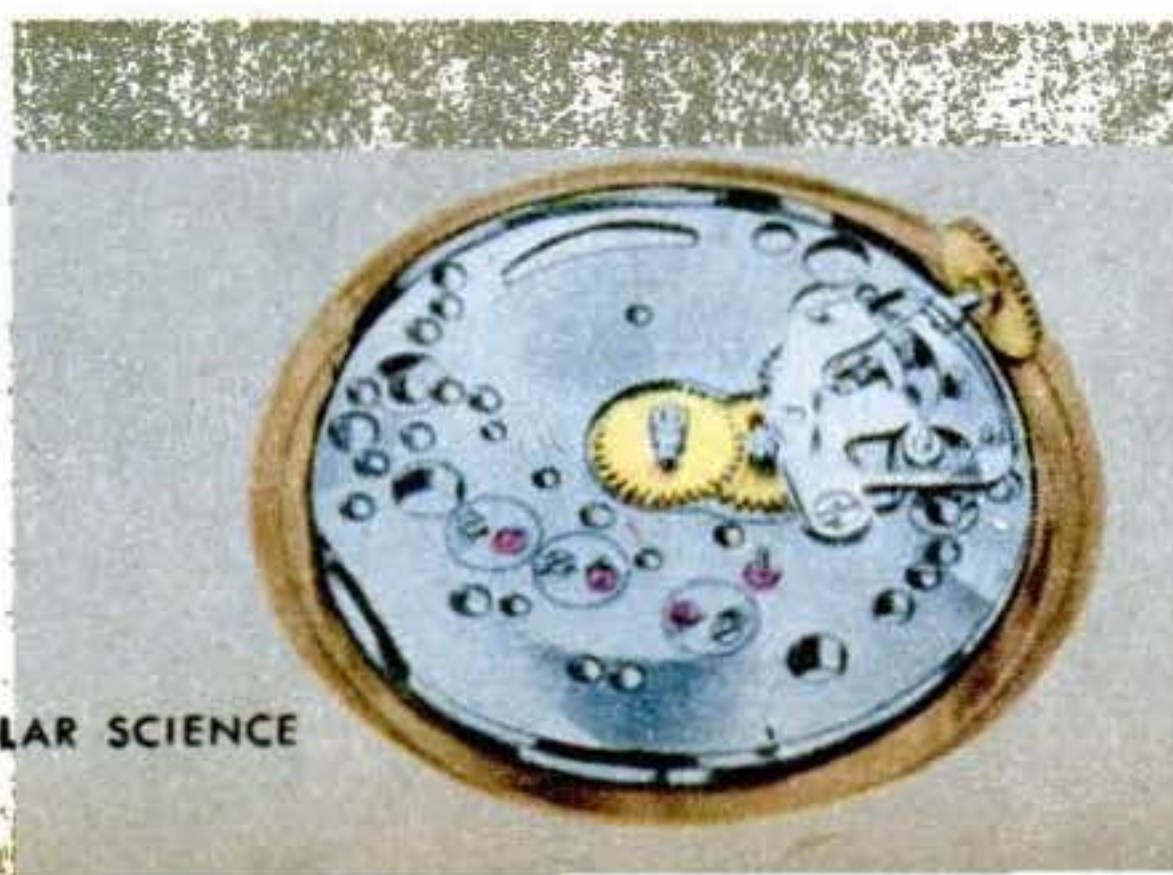
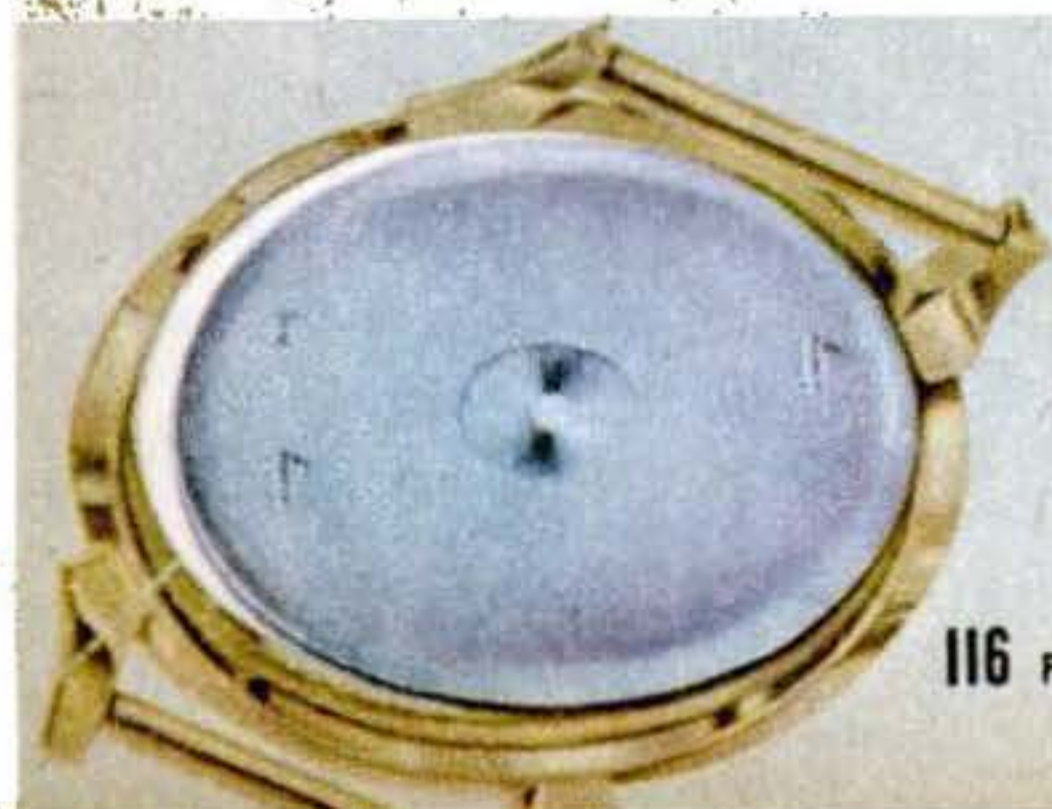

2 Now the dial has been lifted off and placed at left, face down. This uncovers the hour wheel (shown in yellow) and yoke. Since all parts are always available they can be studied at leisure.

3 Now the yoke and hour wheel; crown stem; clutch, setting, and minute wheels; setting and clutch levers; and setting-lever spring have all been peeled off. This leaves the pillar plate exposed at right.

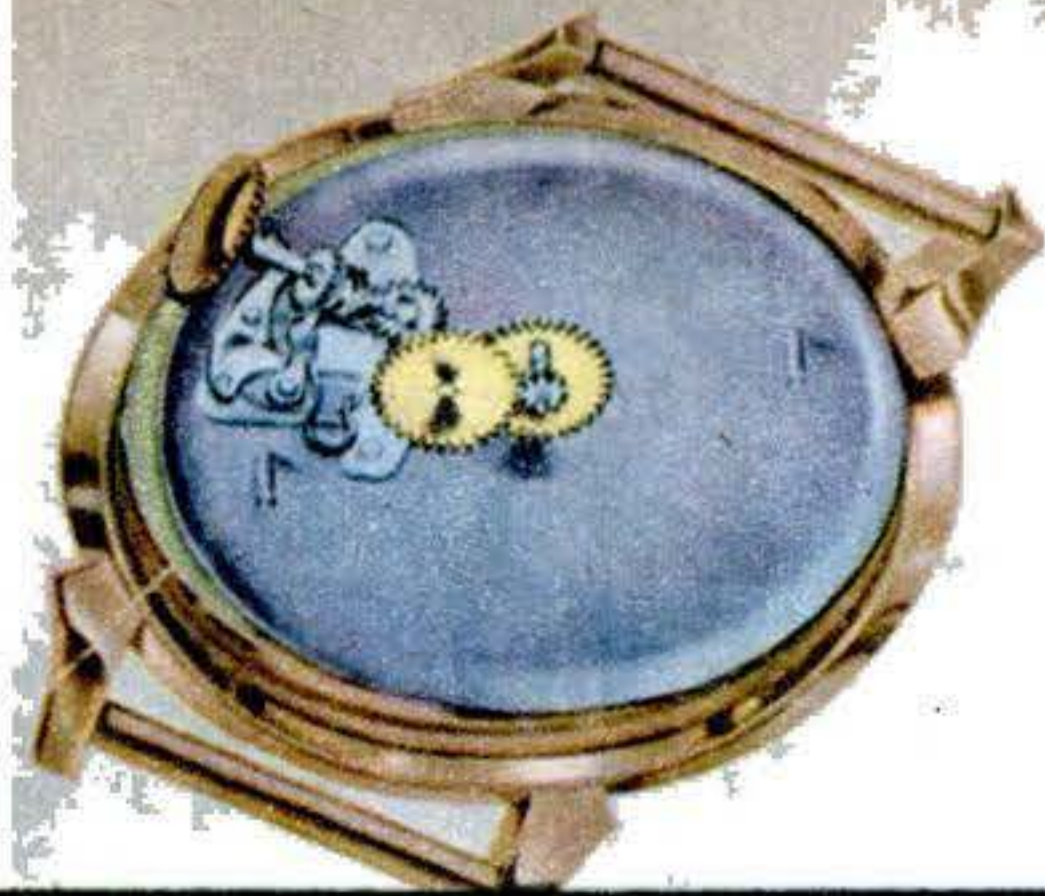

4 Another page exposes the movement side of pillar plate at left, showing barrel recess. This houses barrel, mainspring, and barrel arbor, on right page. Third, fourth and center wheels are in yellow.

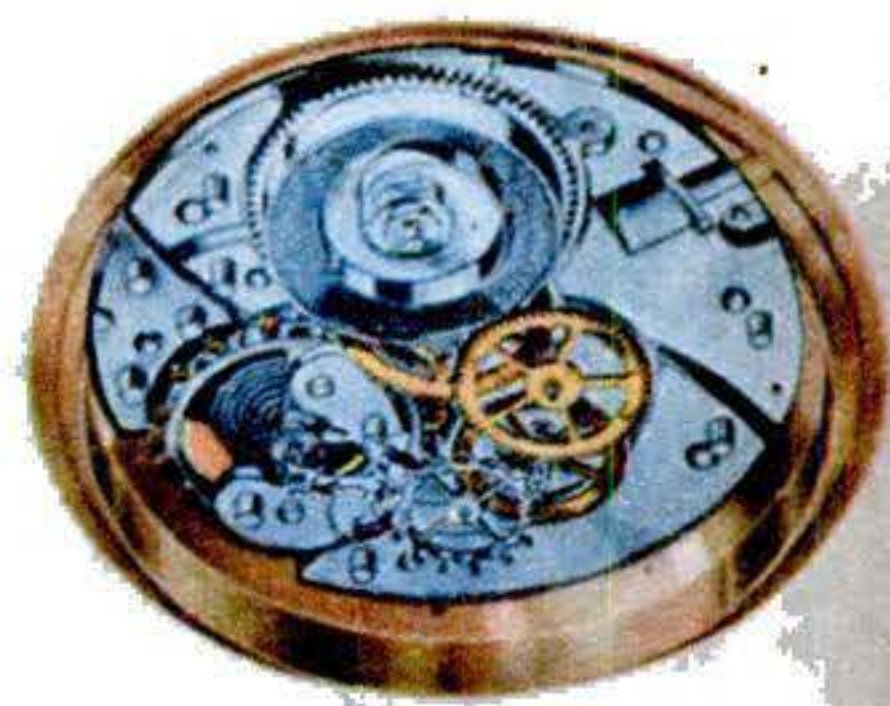

5 Turning over another layer reveals, at right, the barrel bridge (at top), train-wheel bridge with train jewels (lower right), and pallet bridge with pallet-arbor jewel (lower left).



6 Now only a few pieces remain in the watch shell at right. They include the ratchet and crown wheels and the click (at top), balance bridge and wheel, the hair spring, and the roller with its jewel.



7 The watch has now been rebuilt in reverse in the left-hand column. Closing the back cover of the booklet, at right, fits the back of the case over the works. An automobile could be stripped as easily.

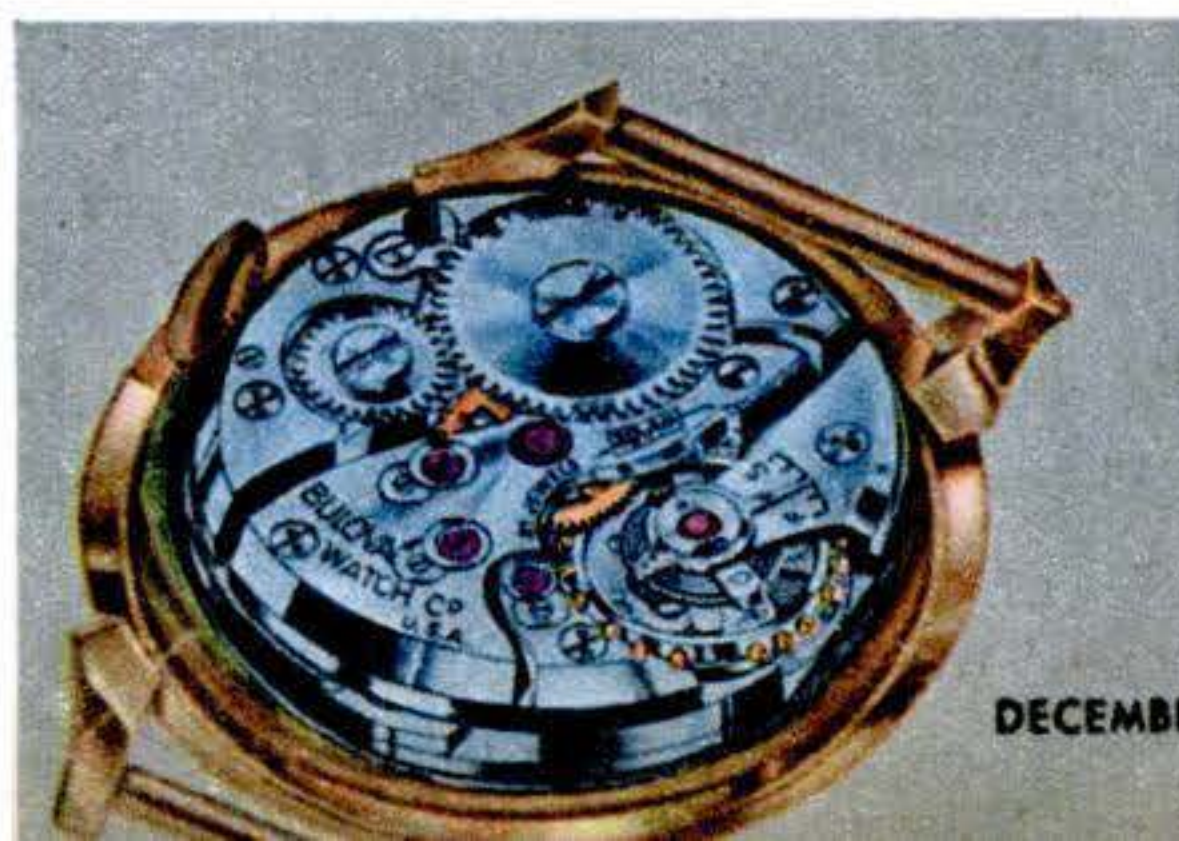



— 2,600 LB. = 250 MILES

This saving was accomplished by substituting eight 56-inch wheels, like those shown above, for the two massive 110-inch wheels used on the main landing gear of the experimental model. Better weight distribution allows use of lower-strength runways.

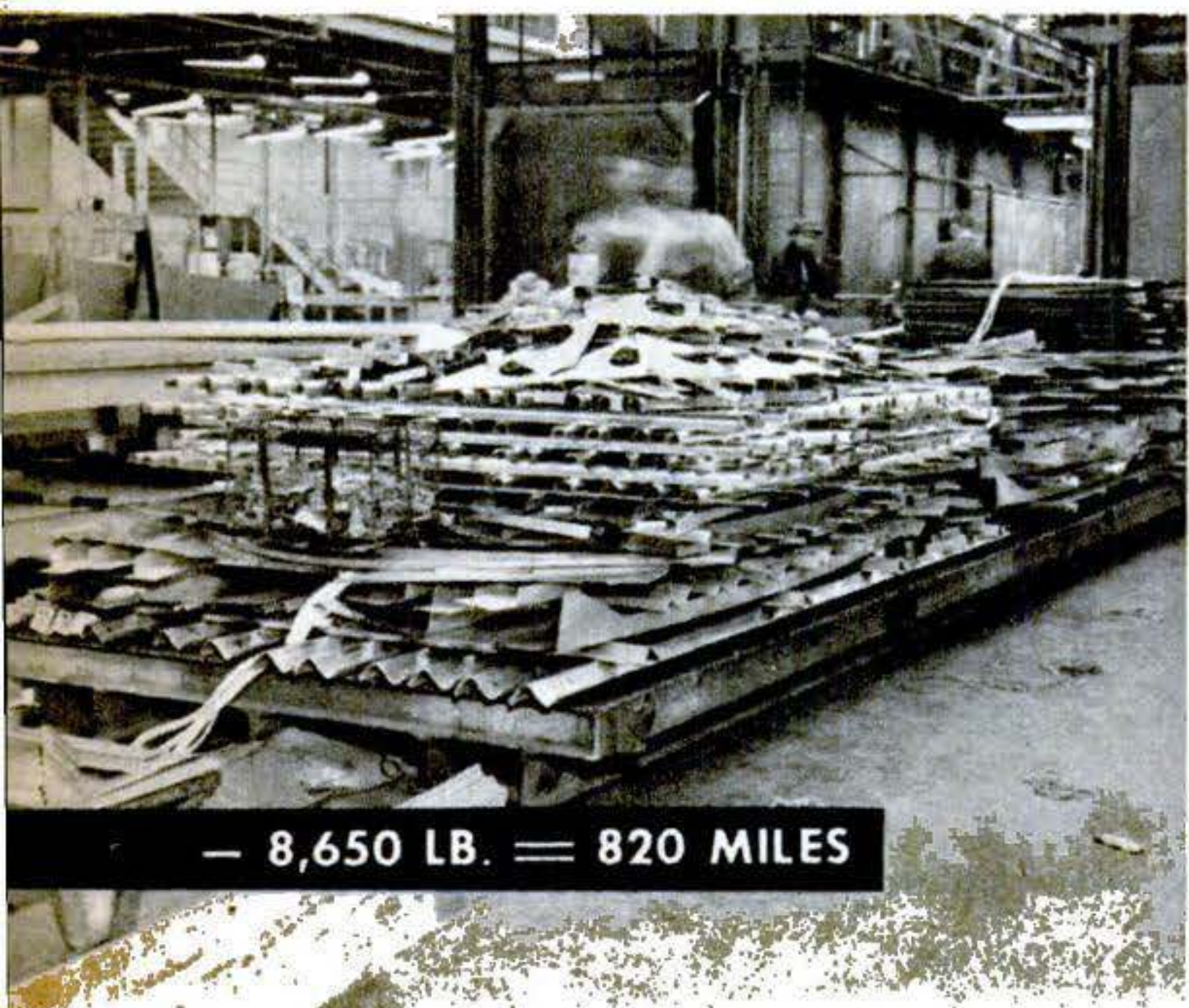

— 8,650 LB. = 820 MILES

Artificial aging of aluminum alloy in a furnace (above) saved 6,750 lb. because increased strength made it possible to reduce the amount used. Substitution of magnesium alloy for aluminum in various places netted an additional saving of 1,900 lb.



Reducing Diet

Sweating 11 tons off the big bomber by ingenious engineering techniques stretches its range 2,000 miles.

EVERY pound of weight in the Air Forces' huge six-engine B-36 bomber requires nearly a pound of fuel and oil to permit the plane to carry its peak bomb load across oceans and Arctic wastes.

That is why this 139-ton aerial giant has been on a strict engineering "diet" from its drawing board days through the assembly-line and flight-testing phases at Consoli-

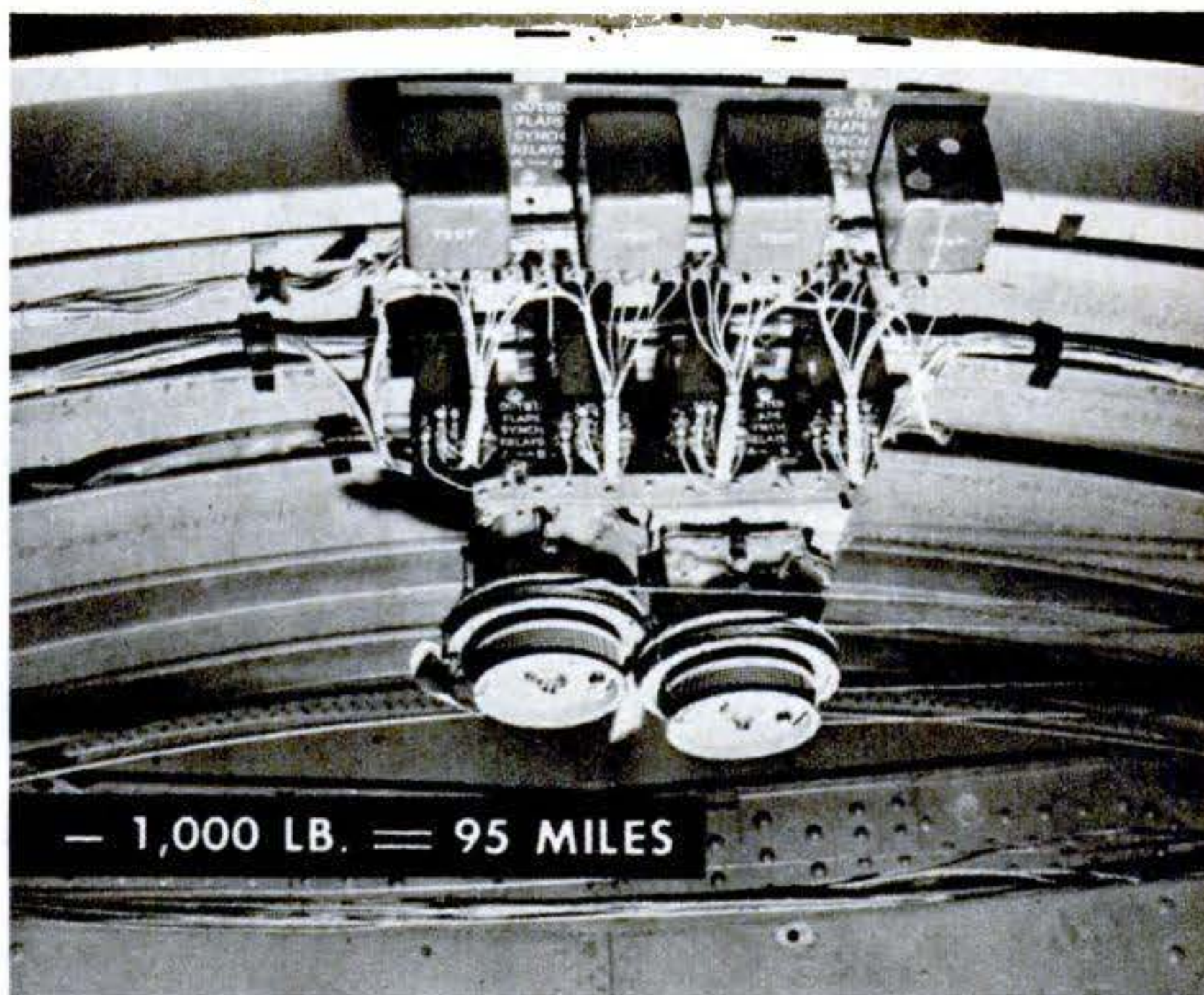

— 1,000 LB. = 95 MILES

More pounds were shed by using these lightweight electromechanical synchronizers to co-ordinate the movement of the B-36's three pairs of wing flaps. Often such pound-saving techniques improve the efficiency of the parts to which they are applied.



for the B-36

dated Vultee's plant in Fort Worth, Tex.

So far, ingenious engineering has sweated more than 11 tons off the B-36's original design—a saving that, if utilized for fuel and oil, would increase its range by more than 2,000 miles. In actual production, however, this weight saving has permitted the installation of tons of new devices and additional equipment developed during the war, while keeping within the 139-ton maximum. That maximum is imposed by the requirements of the B-36's job—carrying 10,000 lb. of bombs 10,000 miles, or a peak load of 72,000 lb., its capacity when flying to a target at shorter range. END

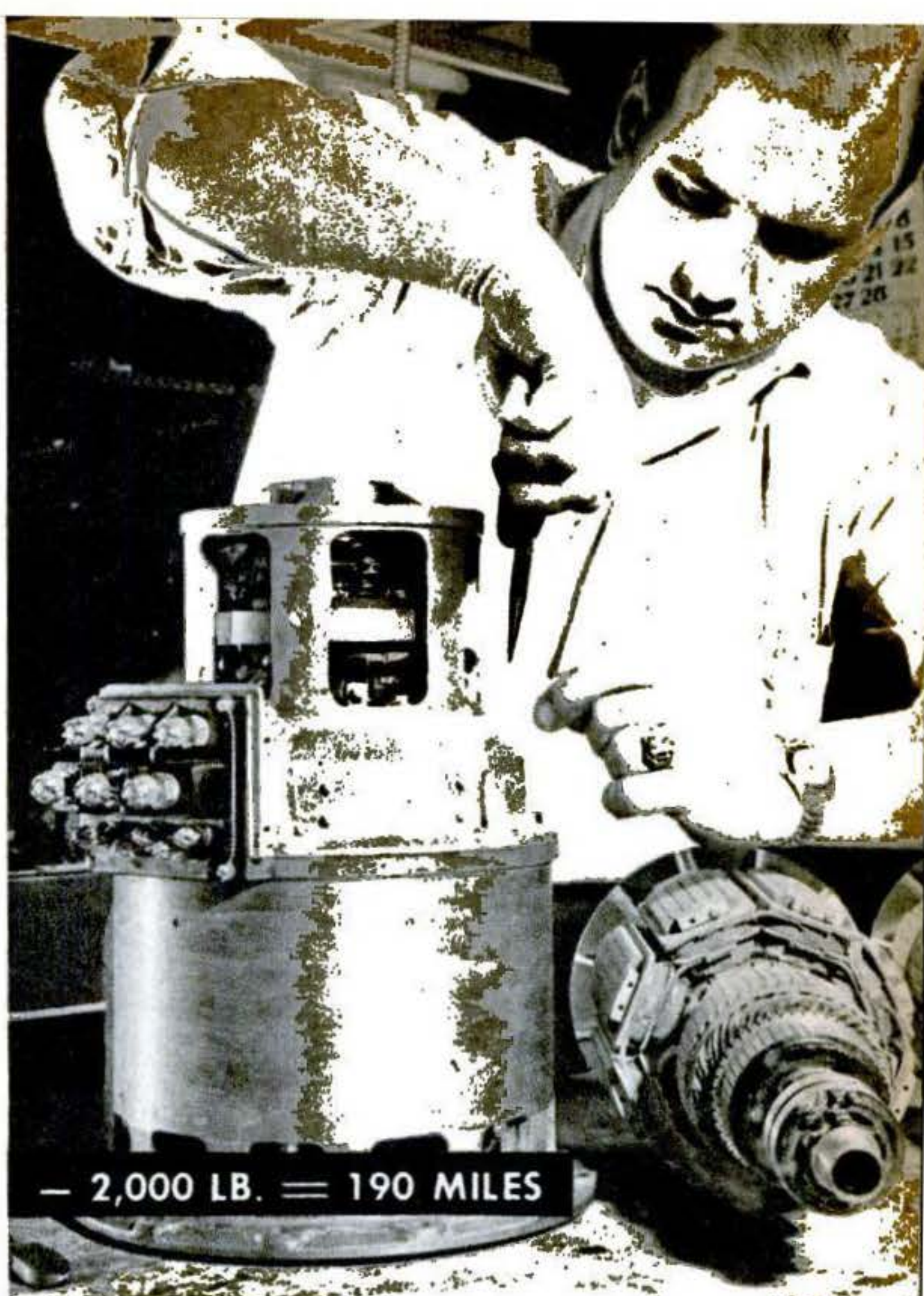

Weight-conscious Convair engineers developed a lightweight alternating-current electrical system to replace direct current in the B-36, thus lopping off another ton. This generator delivers 50 percent more power per pound than a comparable DC machine.

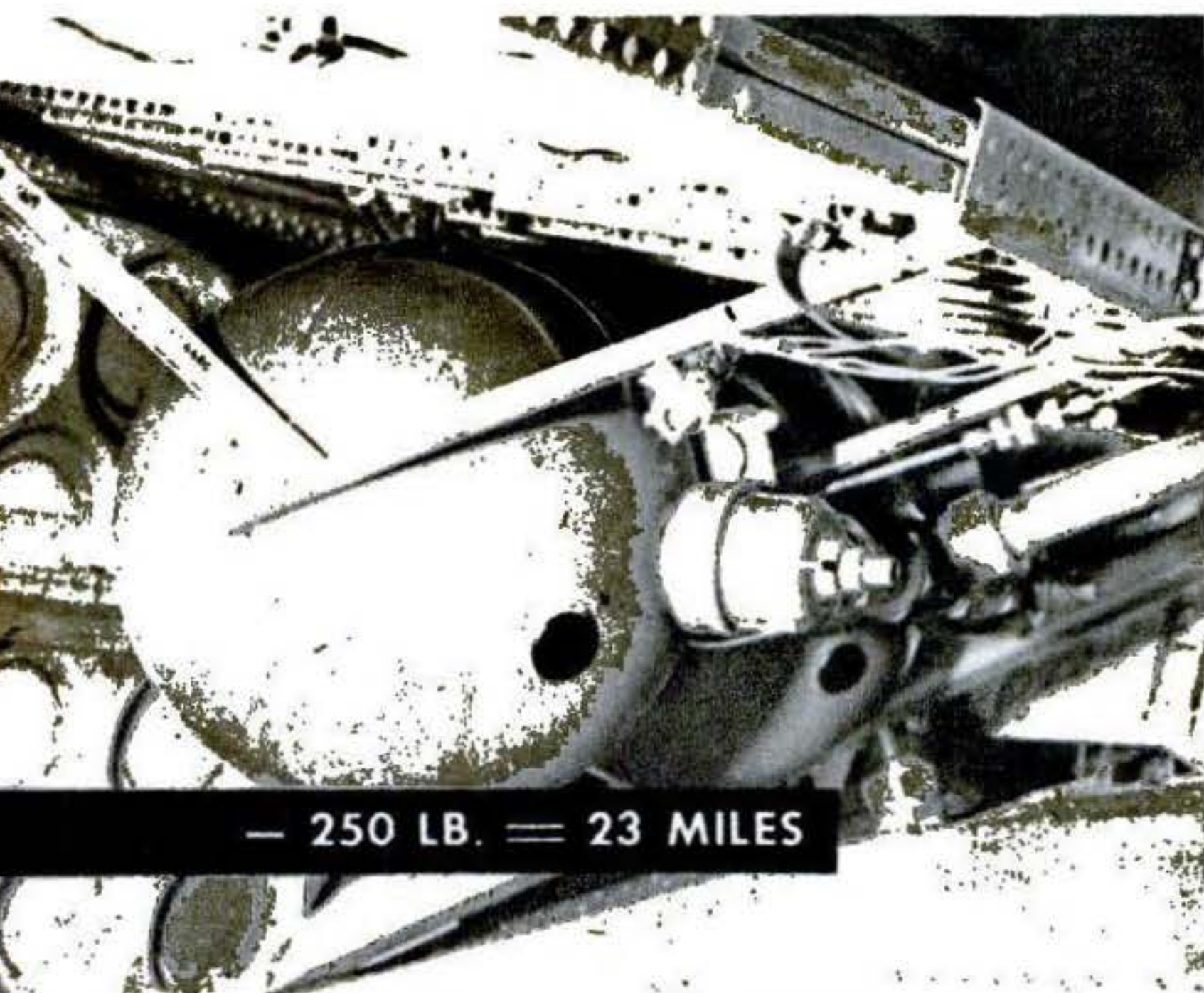

Lightweight containers for fire-extinguishing system did their bit. Substitution of methyl bromide for carbon dioxide also permits the use of smaller quantity of gas stored at a lower pressure. As a result, storage tanks and conducting lines can be made lighter.



An integral fuel-tank system instead of the standard cells or bags contributed this saving. Here bullet-sealing rubber blanket is being attached to outboard tank as protection. Inboard tanks are not sealed, since they would be empty before reaching target.

Switchyard for Air Liners

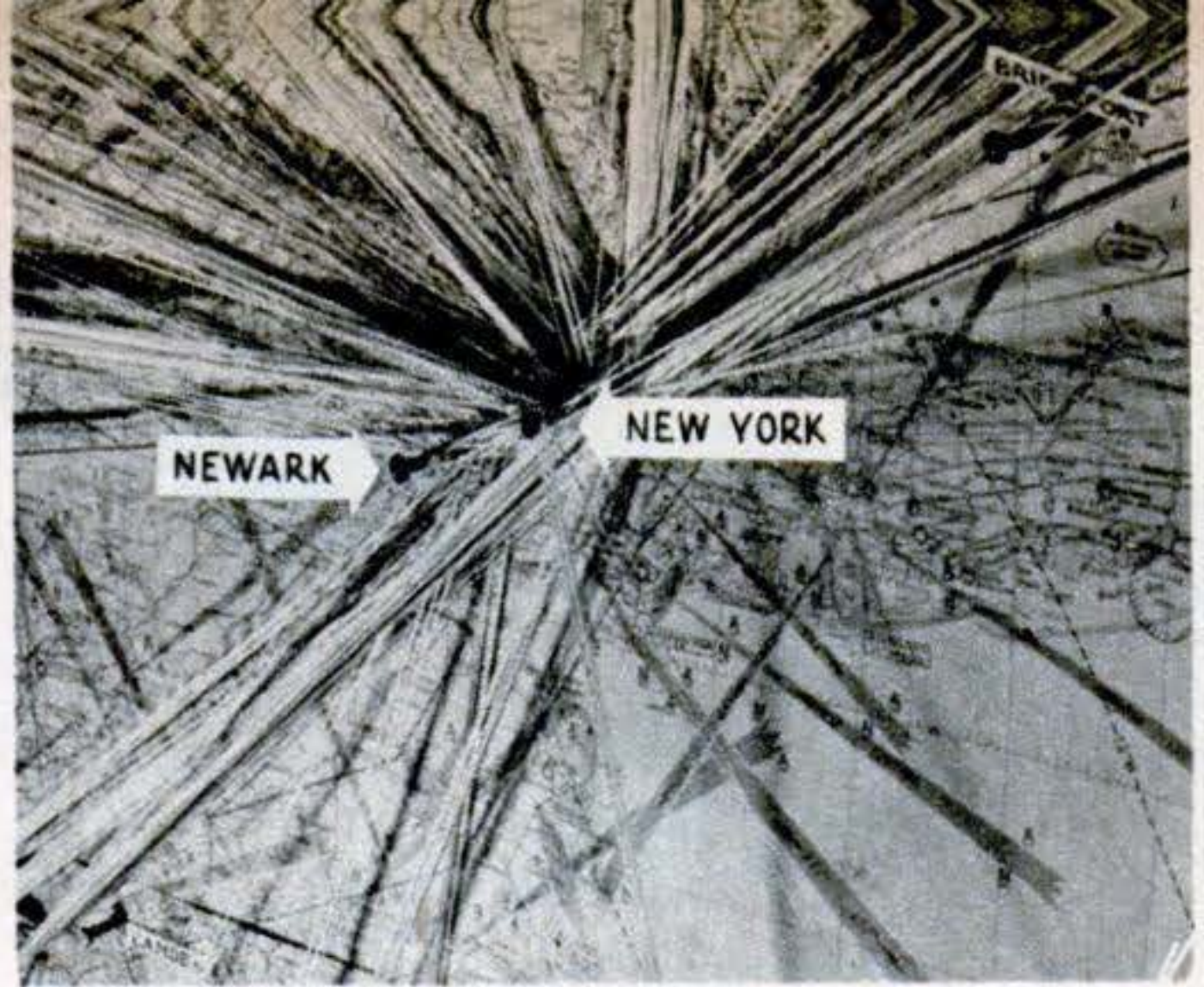

The Problem: The mess of string on a map (above, at right) at the Airborne Instruments Laboratory in Mineola, N. Y., shows New York City's air-traffic problem. There are almost 600 strands, representing

that many scheduled air-line flights every 24 hours. In good weather, traffic control is no problem; when ceiling and visibility are low, it's a prime headache. What can be done to remedy it?

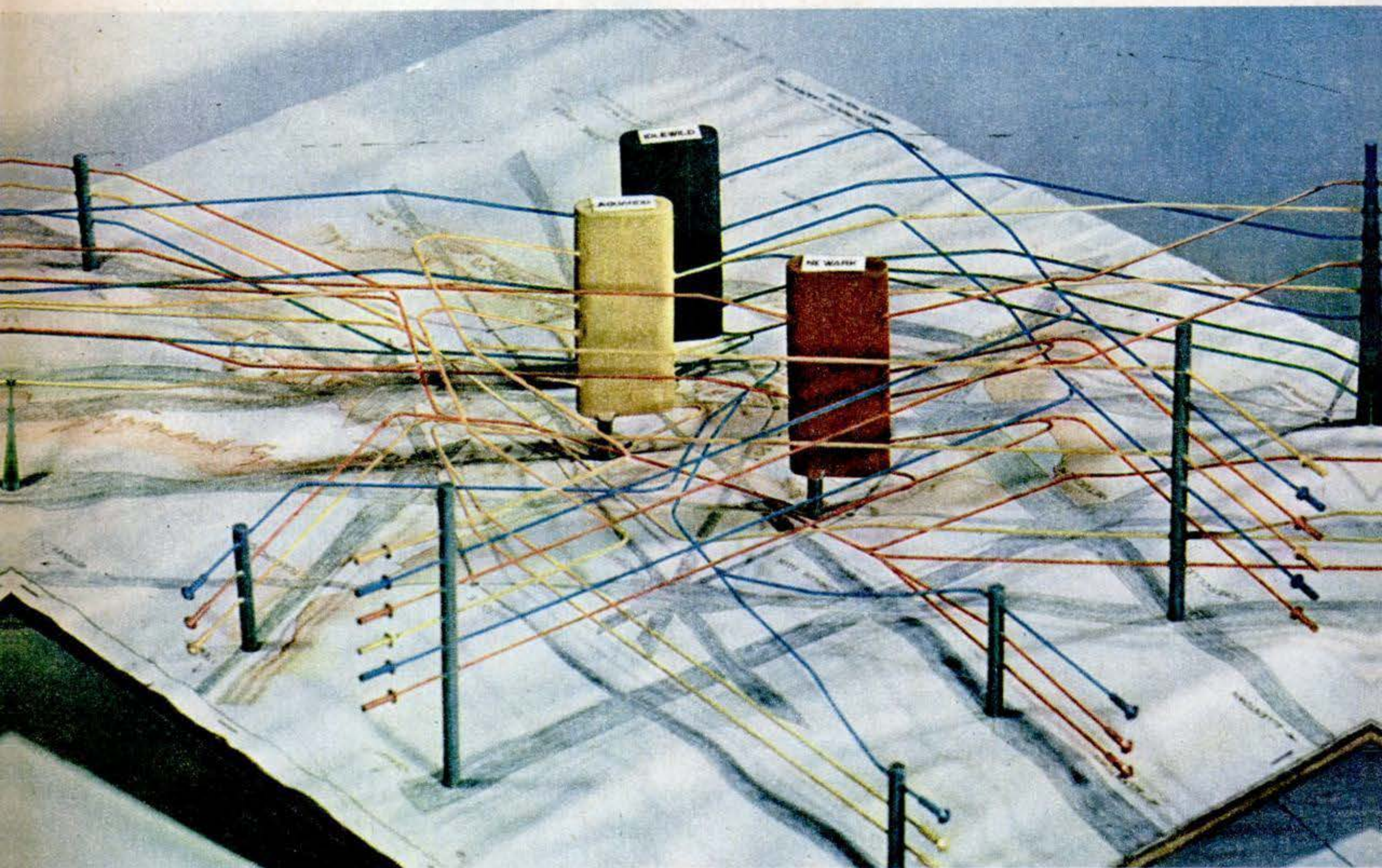

A Solution: This model, made of wire, illustrates one proposal made by the laboratory to the Air Transport Association to double the number of planes handled in the metropolitan area under marginal weather conditions. Viewed from the northwest, it shows nonconflicting incoming and outgoing routes provided for each of the area's three major airports. Planes using the routes would have the safeguard of both horizontal and vertical separation.

The three columns—red for Newark Air-

port, yellow for LaGuardia, blue for Idlewild—are "stack orbits" where planes would loaf until they could land. In landing, a plane would leave its orbit and fly outbound on a "timing loop" designed to insure adequate spacing with the plane ahead. The plan contemplates use of ground radar to assist in this time spacing. Outgoing routes split off after take-off to allow rapid dispersal of traffic. Arrows attached to the ends of the wires indicate the proposed routes and show directions of flight.

How Docks Lift Ships from the Sea

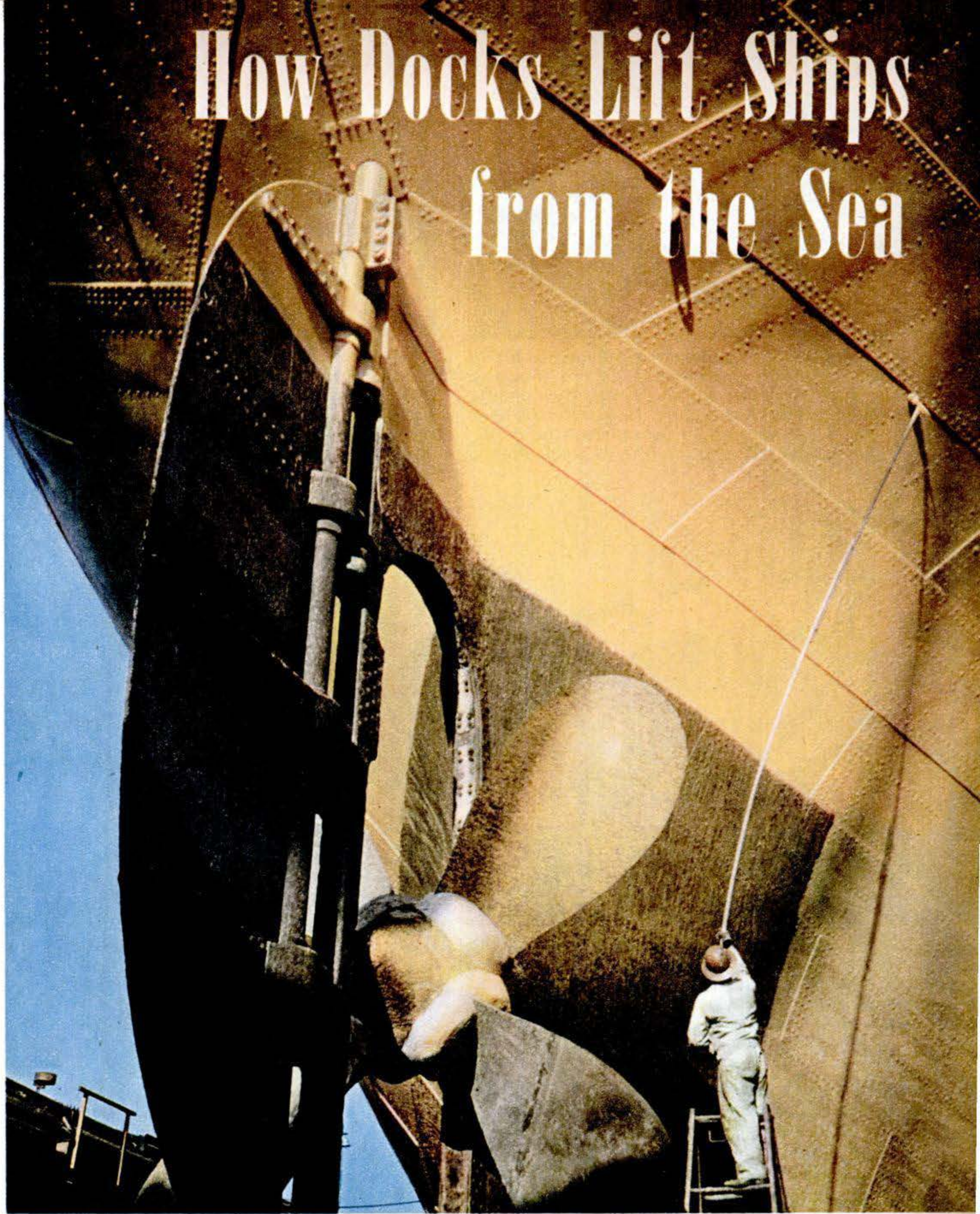

Dry-docked ship is painted to repel barnacles, protect hull from rust and galvanic action.

ONLY part of a big ship's lifetime is spent in the water. Periodically she must be dry-docked, usually twice a year, to repaint her bottom and effect any repairs that may be needed to maintain her hull in seaworthy condition. This may be done either in a graving dock—a basin that can be shut off from the sea and pumped dry—or, more spectacularly, in a floating

dry dock, which actually lifts the vessel bodily from the water.

How a floating dry dock raises an ocean vessel high and dry is shown on the following pages in pictures made by Hubert Lockett, PSM staff photographer, during the recent dry-docking of the 492-foot S.S. *Mormactide* in No. 7 dock of the Todd Shipyards Corporation at Brooklyn, N. Y.

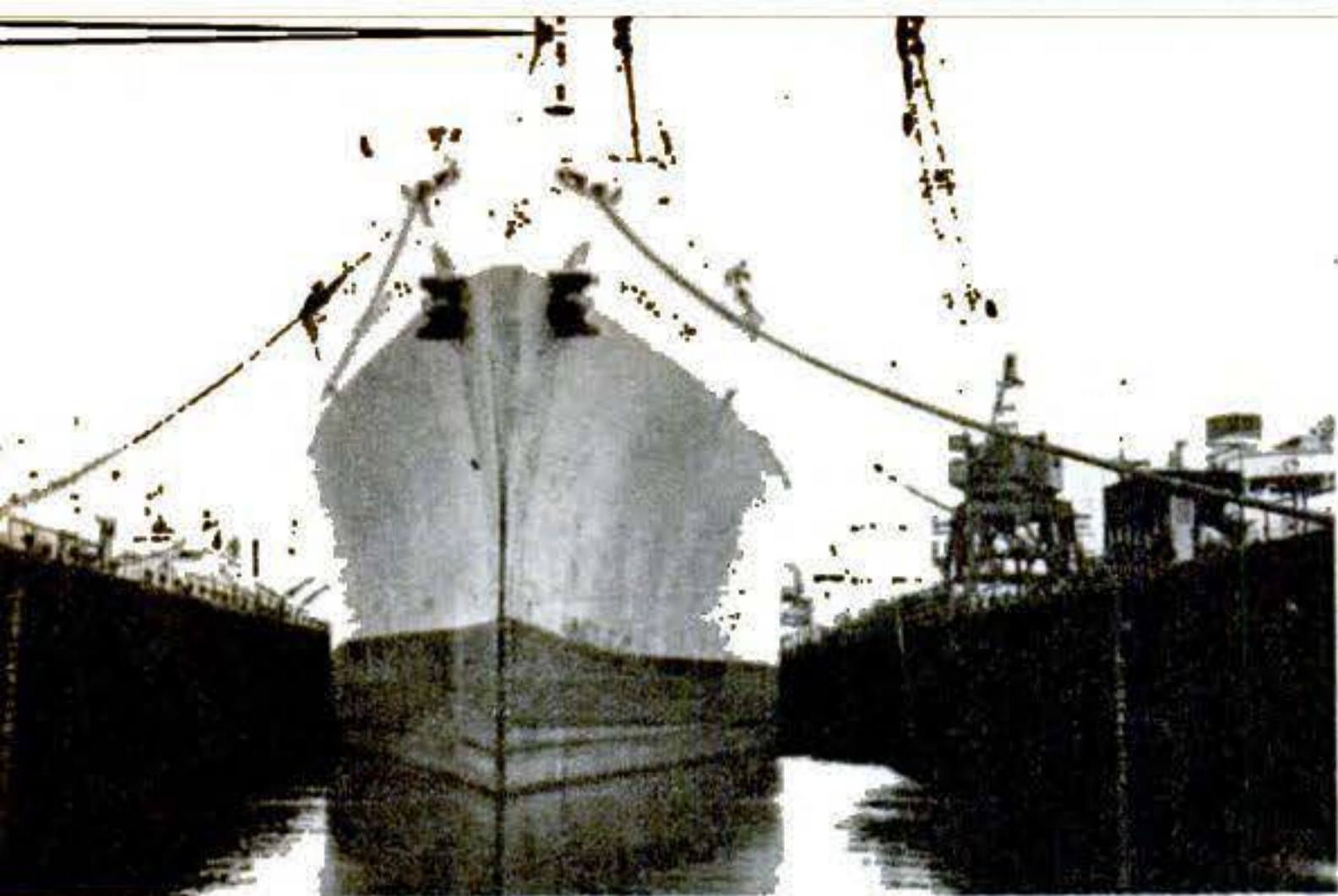

1. S.S. *Mormactide*, passenger-cargo ship of 17,600 tons displacement, enters floating dry dock for periodic overhaul. By flooding its buoyancy compartments, dock has been lowered far enough to provide ample depth of water over its center line of keel blocks.



2. Deck winches at bow of ship take up lines made fast ashore and slowly draw vessel into place, under control of tugboats holding back on stern lines. Dockmaster with microphone, in foreground, directs entire operation through system of loudspeakers.



5. In control room on dock, operator flicks electric switches actuating pumps, valves. Pumps empty buoyancy compartments and dock rises at rate of one foot in 45 seconds, lifting the big ship bodily. Water around vessel spills from open ends of rising dock.



6. An overhauling crew swarms into dock as last of water drains out, leaving ship high and dry on the blocks. Using long-handled scrapers and wire brushes, men remove all traces of rust and marine growth from ship's bottom in preparation for repainting job.

Built during the war to U. S. Navy design, this 622-foot-long steel dock has a lifting capacity of 18,000 tons. Its exceptional width, 96 feet, admits ships of unusually wide beam. Shaped like a box without a cover or ends, this dock has 16 buoyancy compartments in its side walls.

First step in lifting a ship from the sea is to lower the dock by flooding these compartments. A ship can then be floated in at the open end, over a line of massive wooden blocks extending along the center to support the vessel's keel. These are submerged 28 feet beneath the water at maximum operating depth. Movable bilge blocks, "tailor-made" in advance from plans of the particular vessel to be docked, are brought

up against her sides after she is in place to help hold her securely while she is out of the water.

Pumps now empty the buoyancy tanks and the lightened dry dock rises, lifting the ship from her natural element. Water within the dock spills from its open ends as it rises, until all has drained out. As soon as the ship and the floor of the dock are high and dry, workmen swarm into the dock to put the vessel in first-class condition in the shortest possible time. Depending on the amount of work to be done, the ship may spend anywhere from a day to several months in dry dock.

A typical hull-painting job calls for three coats, each with a special purpose. Light



3. Measurements with this giant "ruler" help center vessel in dock. After she reaches correct fore-and-aft position, men on dock use power capstans and block-and-tackle rig to move her sideward until she is lined up over the blocks that will support her keel.

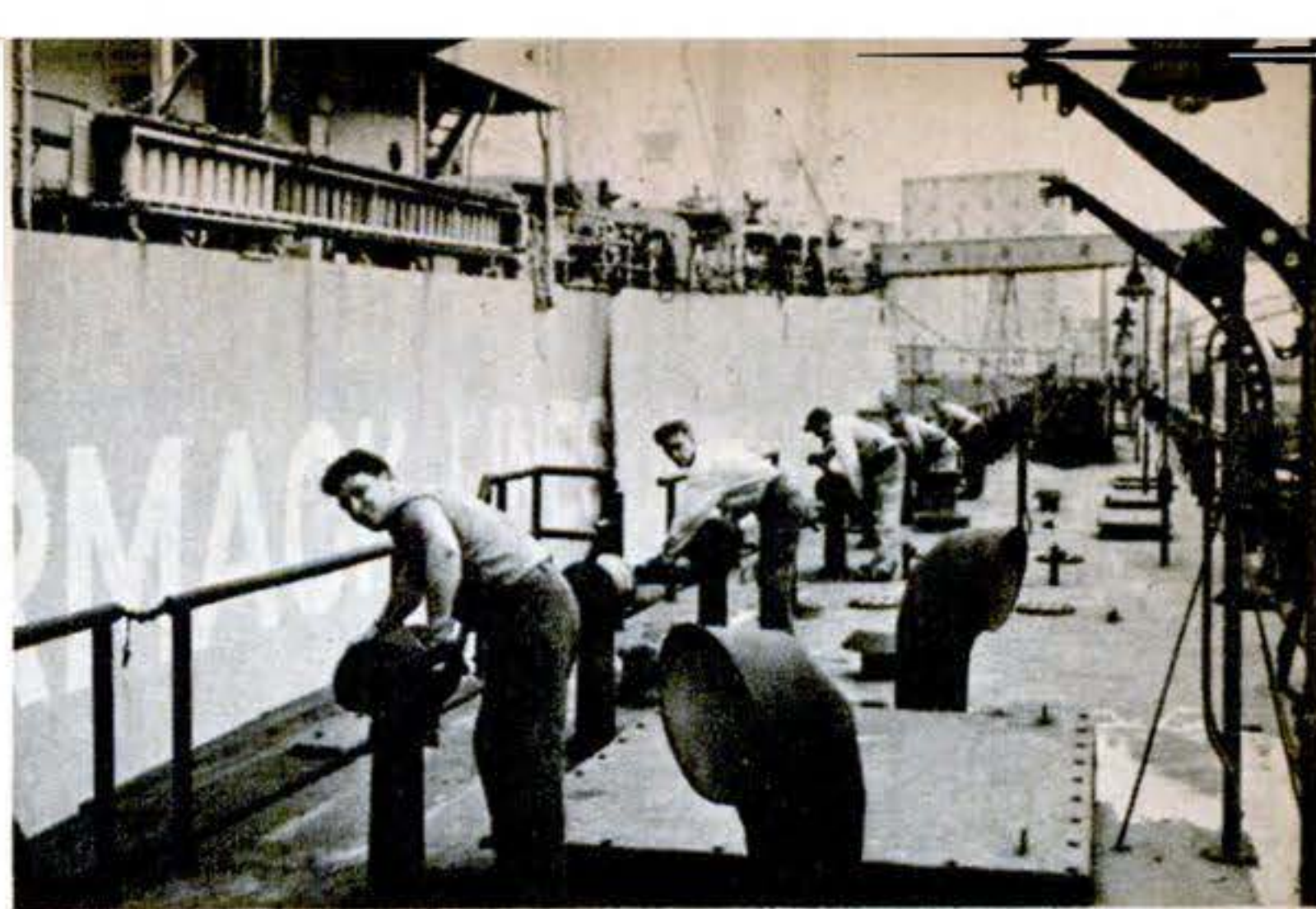

4. Hand cranks along side of dock operate chain-and-pulley gear that moves bilge blocks up against each side of ship, to aid keel blocks in holding her securely while she is out of water. Bilge blocks are carefully "tailored" to fit individual ships.



7. Barnacle's-eye view of bow of vessel gives unusual glimpse of underwater design of a big ship's keel as it rests on wooden blocks in dry dock. Note how successfully the ticklish job of centering the ship over the submerged keel blocks has been accomplished.

red anticorrosive paint protects the hull from rust. Next comes a red coat of anti-fouling paint, a mercurial preparation that repels barnacles and other marine growths. The third coat, a black antigalvanic compound, prevents the steel hull plates from being pitted as a result of losing metal through a process akin to electroplating. But for the compound, this would take place because bronze propellers and steel plates form a natural electric battery when immersed in salt water.

During the periodic dry-docking, a ship's hull gets a rigid inspection for seaworthiness and any necessary repairs are made, such as replacing plates found to be excessively corroded. Grounding or collision may



8. Inspector for marine underwriters, with hammer and flashlight, tests welding of bilge keel, or antirolling fin. When hull has passed rigid inspection for seaworthiness, and repainting is done, dry-docking operation is reversed to refloat the ship.

send a ship to dry dock for more extensive repairs.

Responsibility for the handling of a ship while she is entering and leaving a dry dock falls upon the dockmaster. He used to direct the entire operation with a megaphone, but now he has the aid of a microphone and a system of loudspeakers along the dock and in its control room. The safety of the vessel depends upon his skill in bringing her to rest securely upon the blocks. Orlando Dewling, assistant dockmaster at the Brooklyn yard, who superintended the docking of the *Mormactide*, says that no ship in his charge has ever keeled over during the docking operation. When one does, he plans to look for another job. **END**

Plastic Toys

Learn to Crawl, Wiggle and Pop

ALTHOUGH metals for toys are more plentiful now, the war-born use of plastic substitutes is still enjoying a well-earned popularity with the toy makers—and the youngsters. Here are three new recruits to the growing ranks of plastic toys.



Plastic and elastic allow Swimbo to wiggle through the water like an elusive trout. A tiny crank in the nose winds a rubber band inside that gives undulating motion to the flexible, sectional body. The toy fish is made by Bantam-U. S. Toys, Inc., of N. Y.

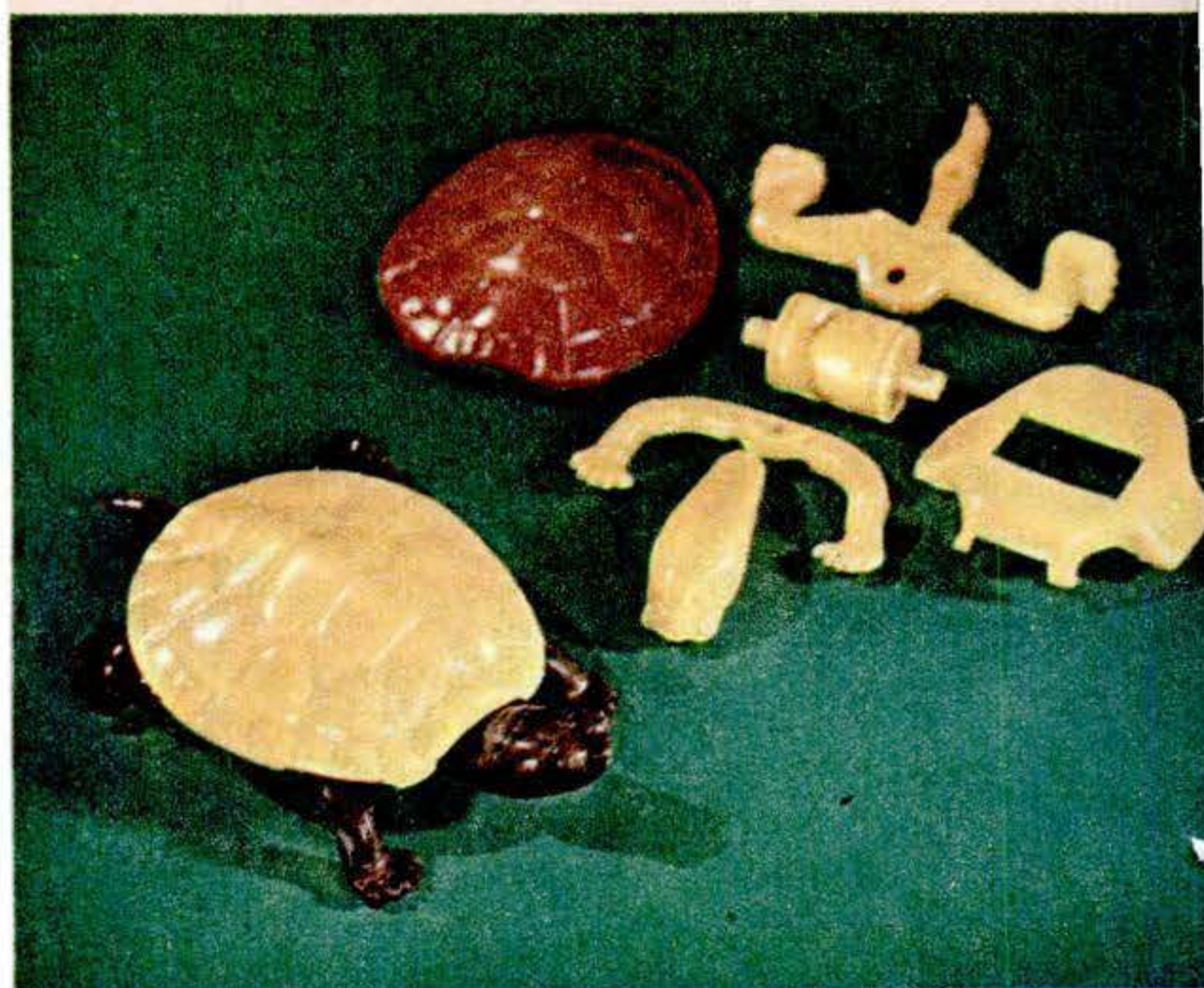

A guiding hand is all that is needed to put Slowpoke in action. Operated by a central cam, the head, legs and tail move when the turtle is pushed. The head bobs, the legs walk, the tail wags. It is made by Samuel Eppy & Co., of New York City.

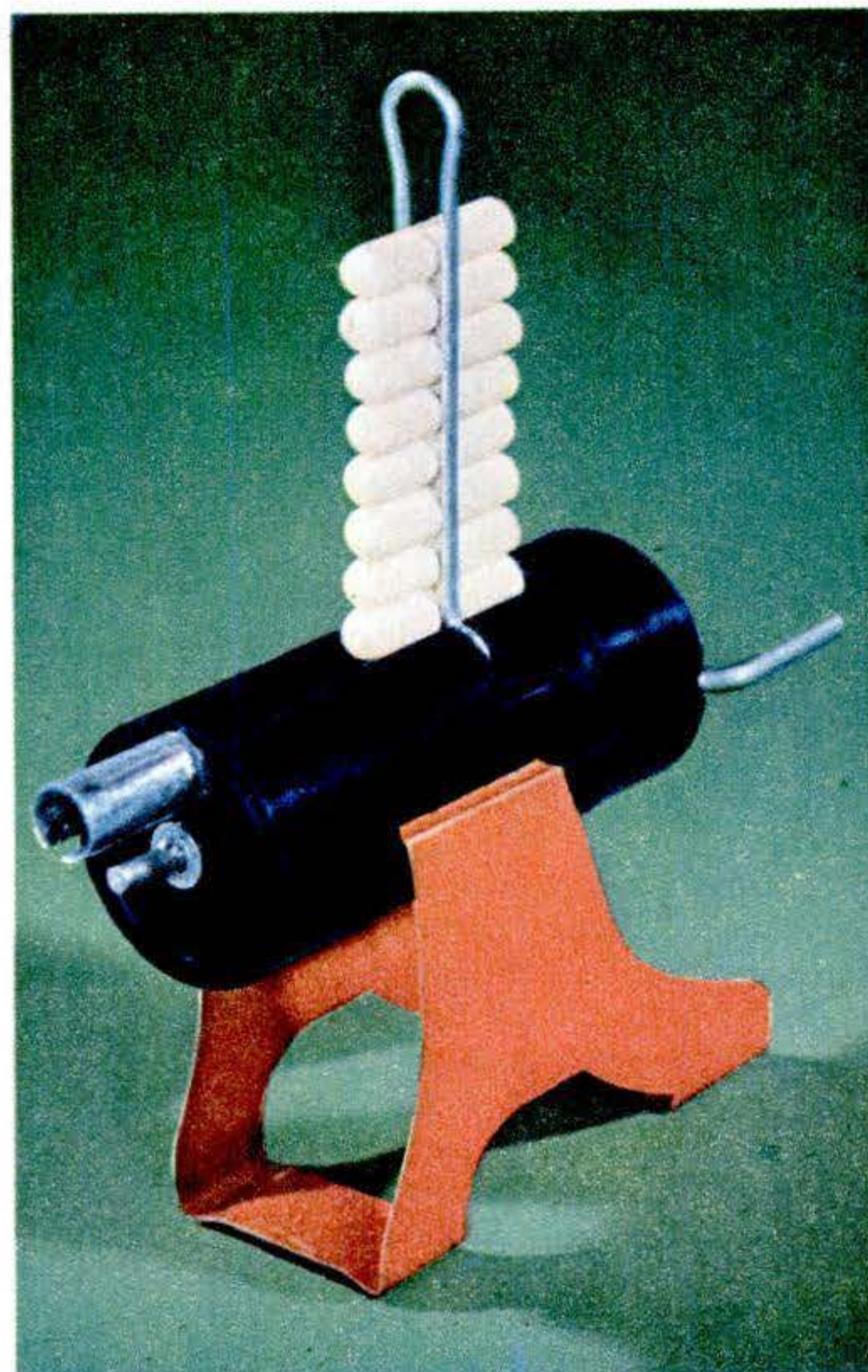

Shooting 10 wooden pellets as rapidly as a youngster can turn the small crank in the end of its breech, this toy machine gun features a barrel of polished Bakelite. The Baldwin Manufacturing Co., of Brooklyn, N. Y., produces the realistic toy.

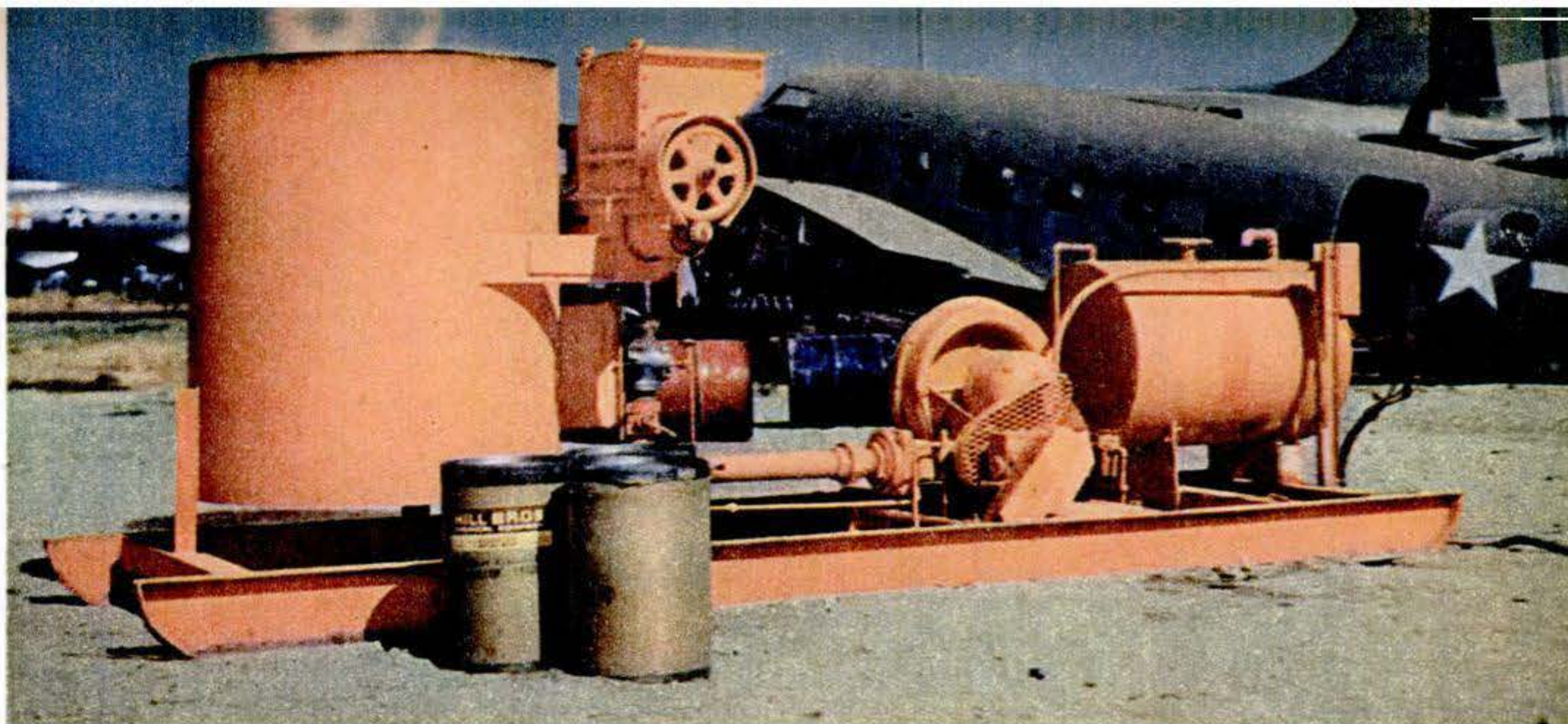

Chemicals Clear Fog

THIS giant "smudge pot" burns a mixture of chemicals at 3,000° F. to produce a vapor that disperses fog at airports. Swirling upward, the vapor lowers the humidity,

clearing the fog. The 14½-foot, 3½-ton vaporizer, shown above at the Lockheed Air Terminal, Burbank, Calif., consumes 100 gal. of fuel oil and 200 pounds of chemicals an hour. Four of them can clear a square mile of fog up to 700 feet in 20 minutes.

Plow Uproots Rocks

TO SPEED the clearing of rough and rolling land for cultivation, this odd machine functions both as plow and ripper.

Pulled by a Diesel-powered tractor, the device has a heavy steel blade, 65 inches long, that slices horizontally through the soil from 18 to 40 inches below the surface. As it moves, the blade loosens roots and stones, bringing them to the surface.

A center point guides the blade into the earth where it automatically flattens into plowing position. In addition to combining two operations in one, the method prepares the land for cultivation without overturning and covering the topsoil.



Pulled up like a draw-bridge, the big blade (above) is easily reached for servicing. Note bulldozer rig on the front end of the tractor (at left) for clearing surface obstacles.

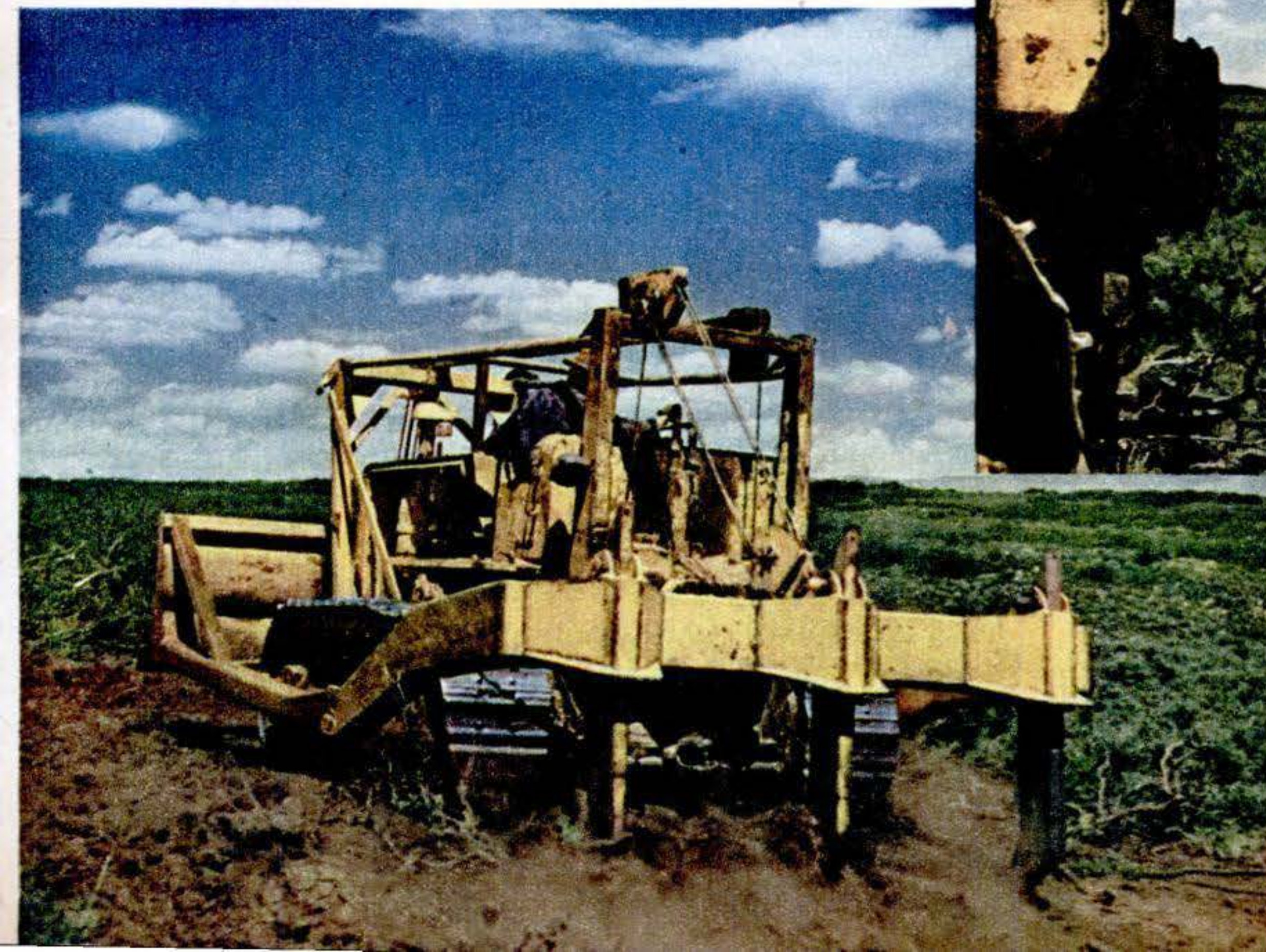



One man can handle the "free" pump unit that is contained in this stainless-steel cylinder 2 inches thick and 10 feet long. Operator is about to lower it down well.

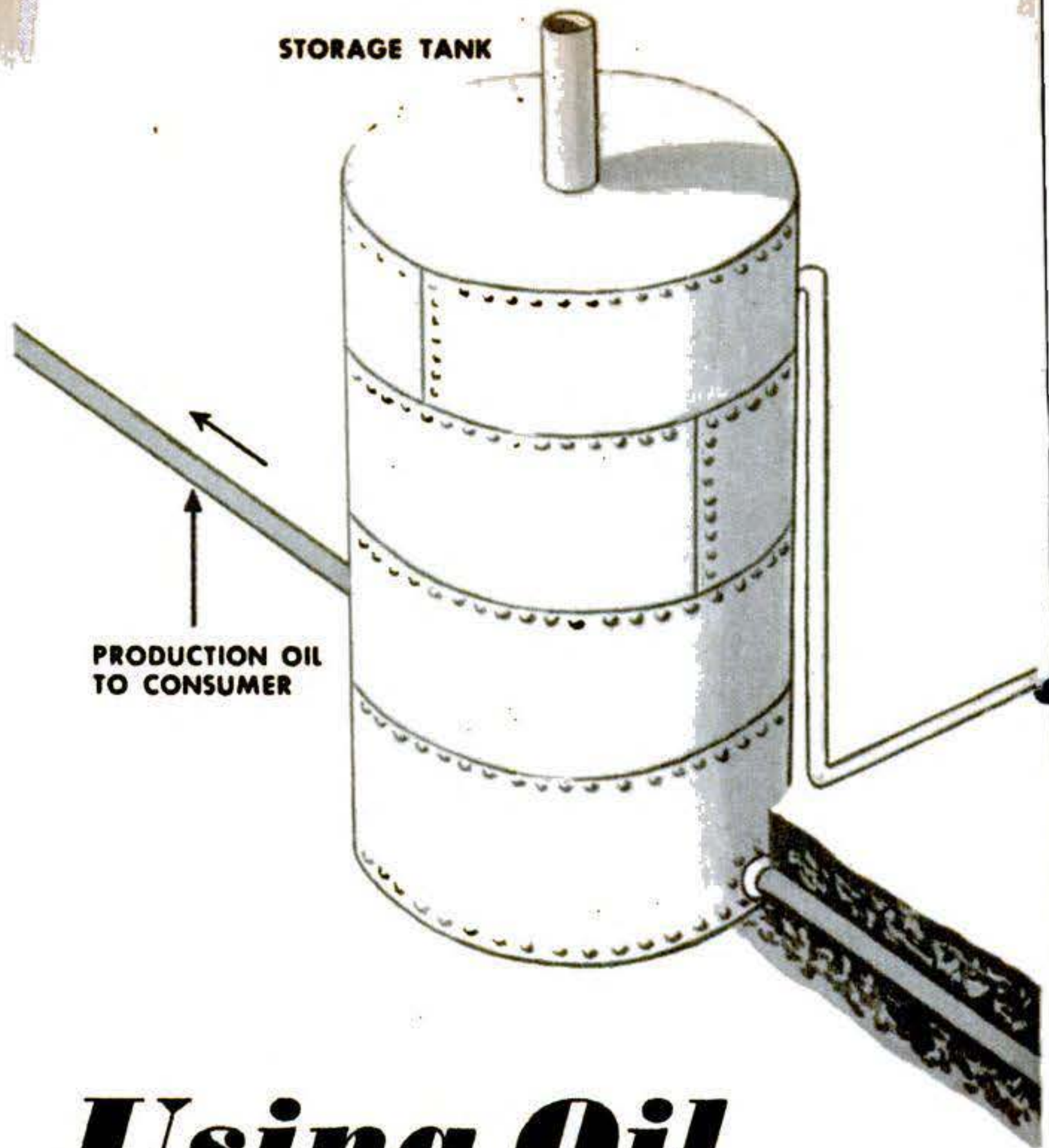

Using Oil to Pump Oil

A NEW, highly efficient, low-cost pumping system may bring new life—and profits—to oil fields abandoned as depleted. It uses oil under pressure to pump production oil up from the bottom of the deepest wells.

Developed by the Kobe Hydraulic Pump Company, of California, the operating unit of the system consists of a hydraulic engine connected to a double-acting piston displacement pump, both contained in a slender steel cylinder. This "free" pump does not have to be attached to the walls of the well pipe as do ordinary pumps, but is simply floated down to the bottom of the well where it is kept firmly seated and operating by a supply of power oil pushed down a feed line under pressure.

The Kobe pump eliminates costly steel derricks and big power plants. One man at one central motor-driven charging pump above ground can feed fluid power to hydraulic units at the bottom of a dozen wells. And units can be dropped down crooked wells, or those under water—wherever the power oil can be piped.

Should the well-bottom pumping unit need repairs, the operator turns a valve reversing the power flow, and the 40-lb. cylinder slides up to the top of the well where it is caught and held by steel grippers.

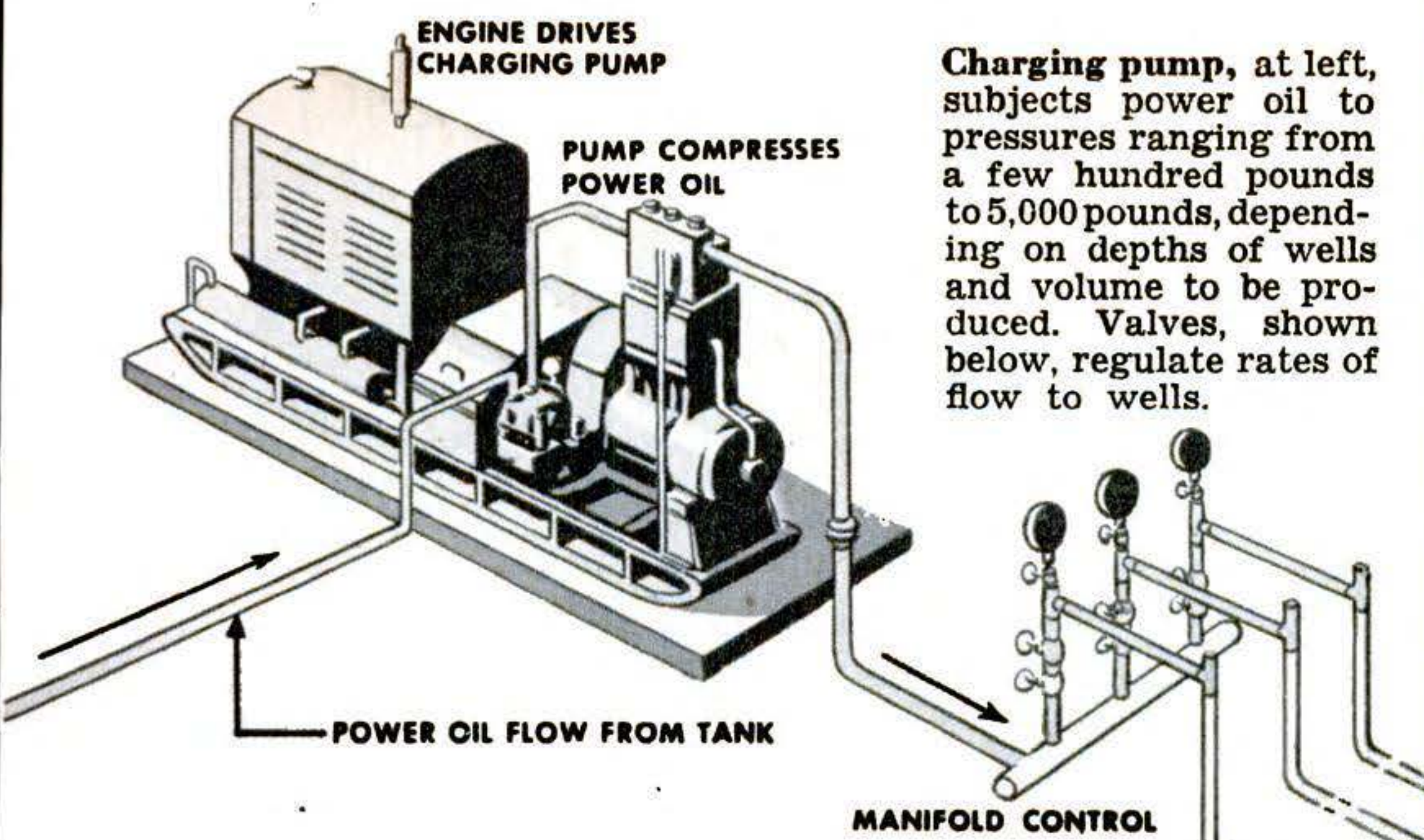

Charging pump, at left, subjects power oil to pressures ranging from a few hundred pounds to 5,000 pounds, depending on depths of wells and volume to be produced. Valves, shown below, regulate rates of flow to wells.

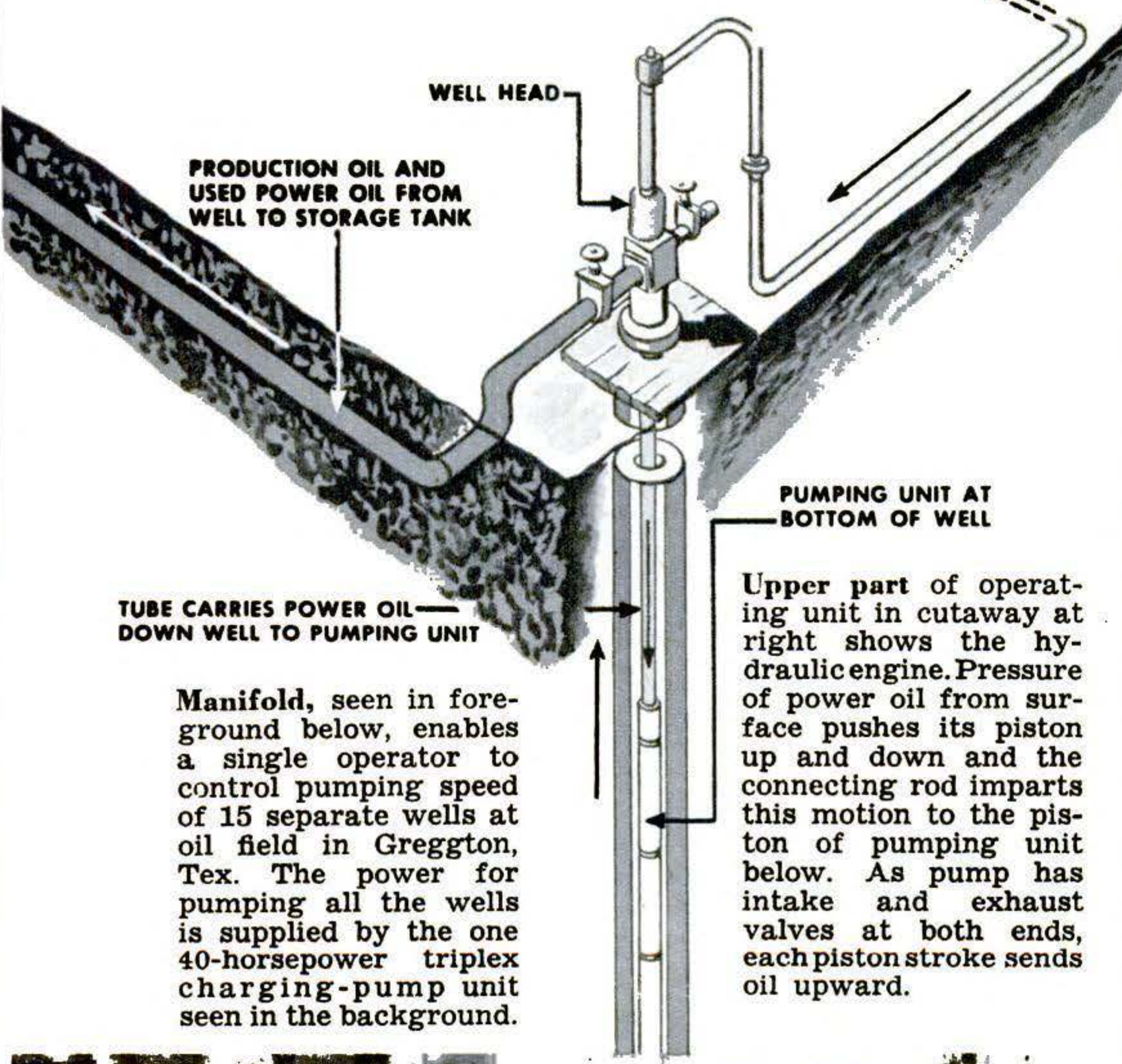

Manifold, seen in foreground below, enables a single operator to control pumping speed of 15 separate wells at oil field in Greggton, Tex. The power for pumping all the wells is supplied by the one 40-horsepower triplex charging-pump unit seen in the background.

Upper part of operating unit in cutaway at right shows the hydraulic engine. Pressure of power oil from surface pushes its piston up and down and the connecting rod imparts this motion to the piston of pumping unit below. As pump has intake and exhaust valves at both ends, each piston stroke sends oil upward.

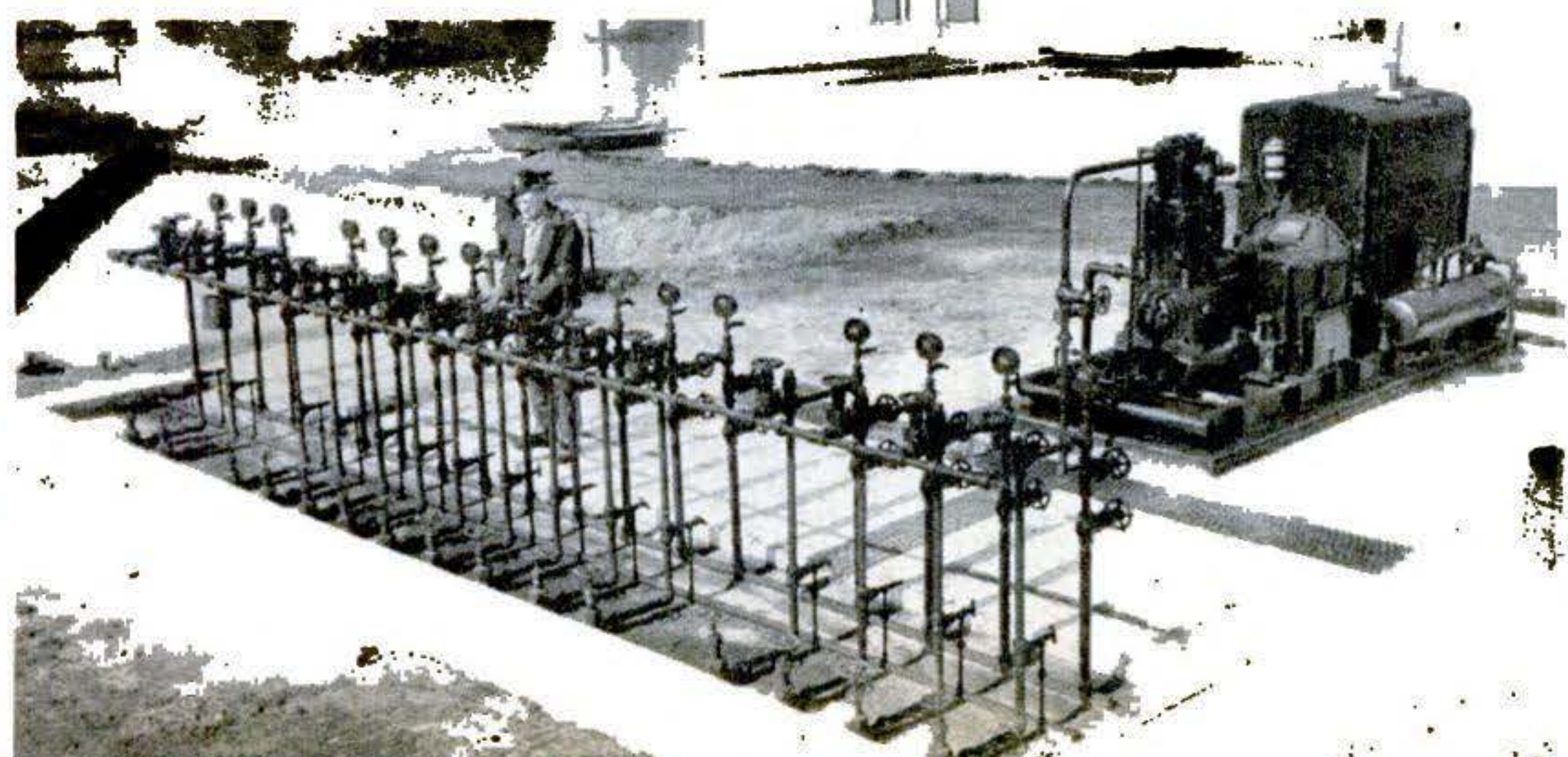
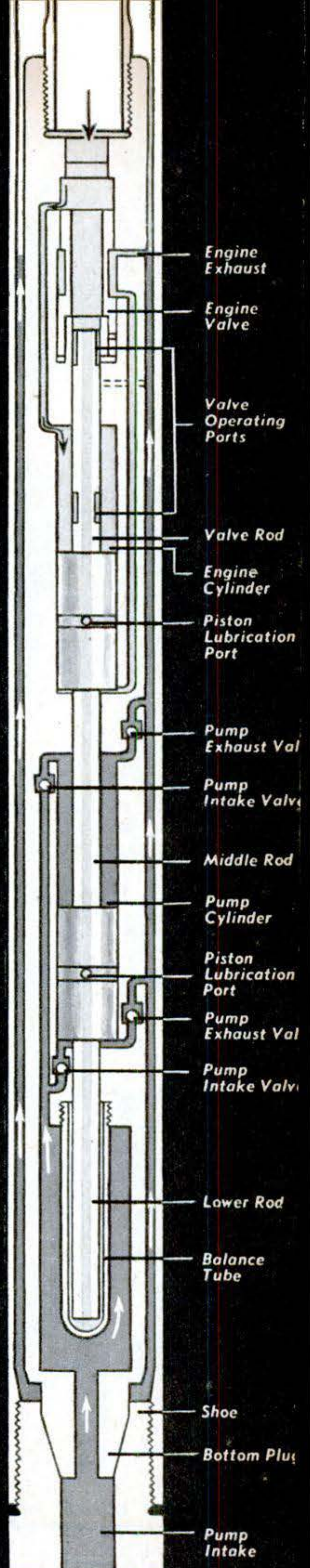



Dressing Up the RFD

THE RFD she ain't what she used to be. Not down in southern Arizona, anyway. Thanks to enthusiasm for ingenious receptacles, the last thing a rural letter carrier expects to drop the mail into is an old-fashioned mailbox. Instead, he is confronted with everything from a converted bomb to a covered wagon. Here are some examples.

Photos by Henry Kahn, from Western Ways



This gay red-and-yellow box, mounted on half a wagon wheel, gives the real Western effect desired by many mailbox decorators.

A model of the traditional prairie schooner holds the mail here. This box belongs to Make-It-Look-Like-Something-Else school.

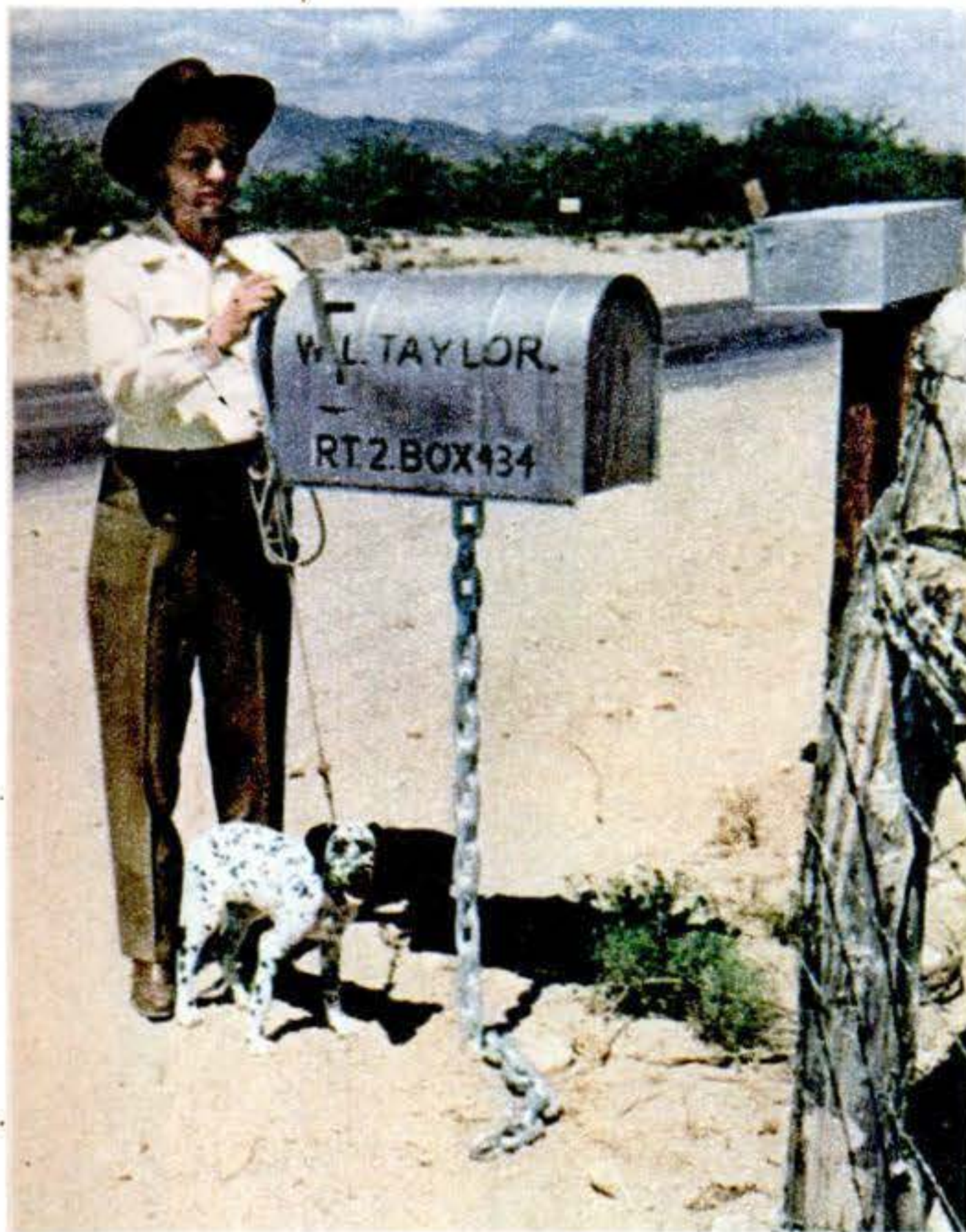

You have to look twice at this one. No, it isn't magic; the links of that innocent-looking chain are welded into a support.

Sheet metal, black paint, and an angle iron from an old bed rail have transformed this box into an old-fashioned street lamp.

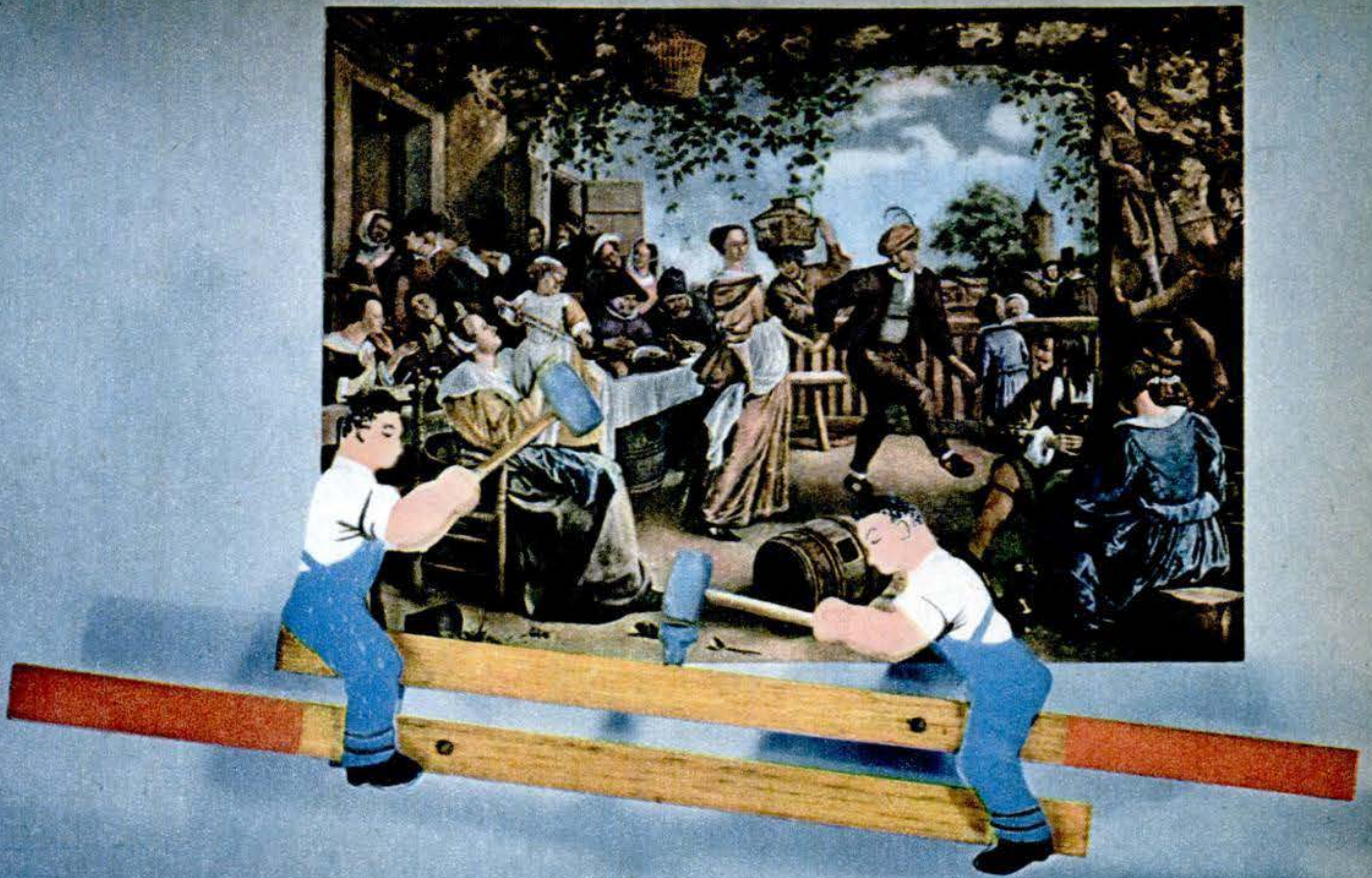

Antique Toy Comes to Life. This project, a nice Christmas gift for preschool youngsters, has a story—and a picture—behind it. Contributor James J. O'Hara brought to PSM a print of the 17th Century Dutch painting above, called *Dancing Couple*, by Jan Steen. If you look closely, you'll see a child on the table with the toy in his (or her) hands. O'Hara said he'd like to build the toy for PSM readers to duplicate, and here it is. When you push and pull on the two sticks, the little figures lustily hammer the anvil, never missing a stroke and always in perfect step. See page 184.

CRAFTWORK PROJECTS OF THE MONTH



Metal Plated on Wood. That's what makes this model plane look so much like the real thing, even to the wing tanks beneath it. You can electroplate almost any surface—metal, wood, plaster, and even baby's first shoes. Turn to page 210.

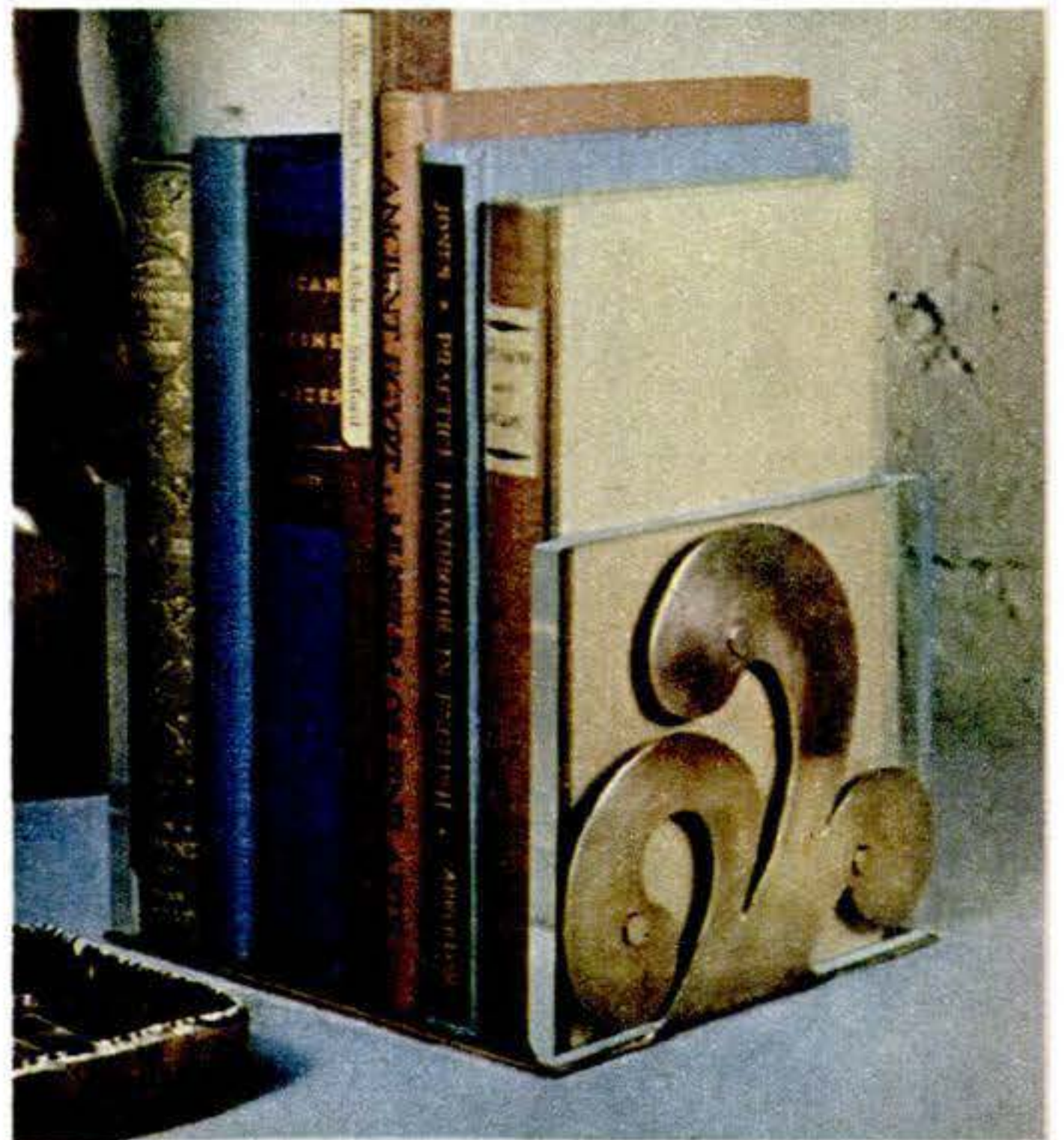

Copper-on-Plastic Book Ends. Here's a perfect wedding of two materials that carry out the modern mood. Burnished copper on sparkling crystal plastic creates a pair of book ends you'll be properly proud of. Simple plans appear on page 188.



NEW IDEAS FROM THE INVENTORS

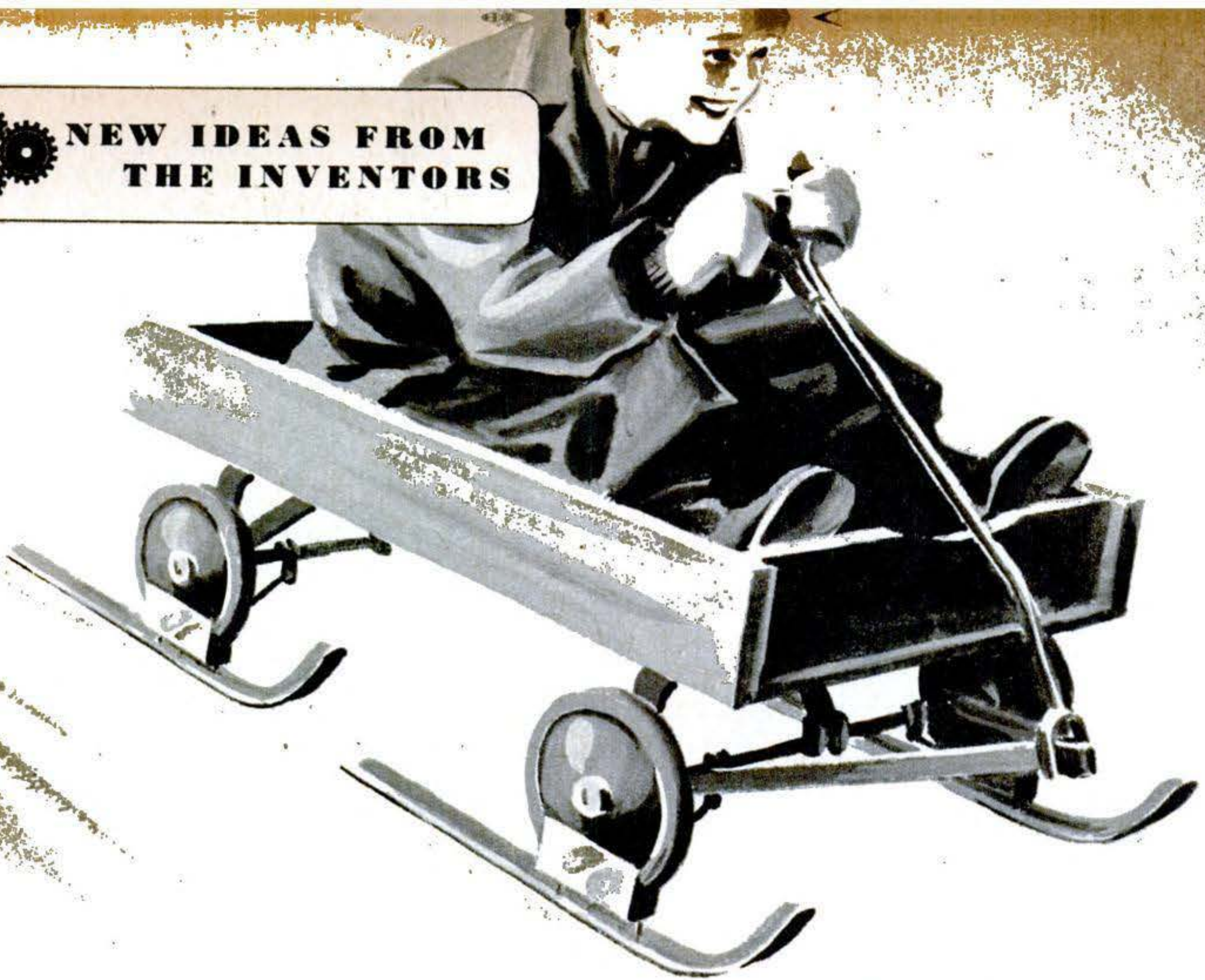

Runners Convert Wagon. Four small wheel runners quickly convert this child's wagon into a steerable sled for use in winter. Patented by Emil Lersch, of Pensacola, Fla., the ski-like, turned-up metal

runners are each clamped firmly to a wheel of the wagon by a pair of side plates shaped to conform closely to the wheel's contours. In addition, angled braces between the runners and the axles provide lateral stability.



Wiper Defrosts Windshield. This wiper is designed to keep your windshield clear of ice, sleet and snow as well as rain. Invented by Reyes de Cordova, of Tracy, Calif., it is an ordinary wiper blade flanked by two electrically heated rollers that rotate against the windshield as the wiper moves back and forth, warming the glass enough to prevent freezing.



Pot Works by Itself. This is a percolator you don't have to watch. As the boiling water rises through the tube, it flows from one side of the two-chambered pot to the other. Its weight tilts the rockered hot-plate base, turning the electric heat down but not off. Patented by Julian Meier, of Detroit, Mich., the percolator can be set to go on at any time.

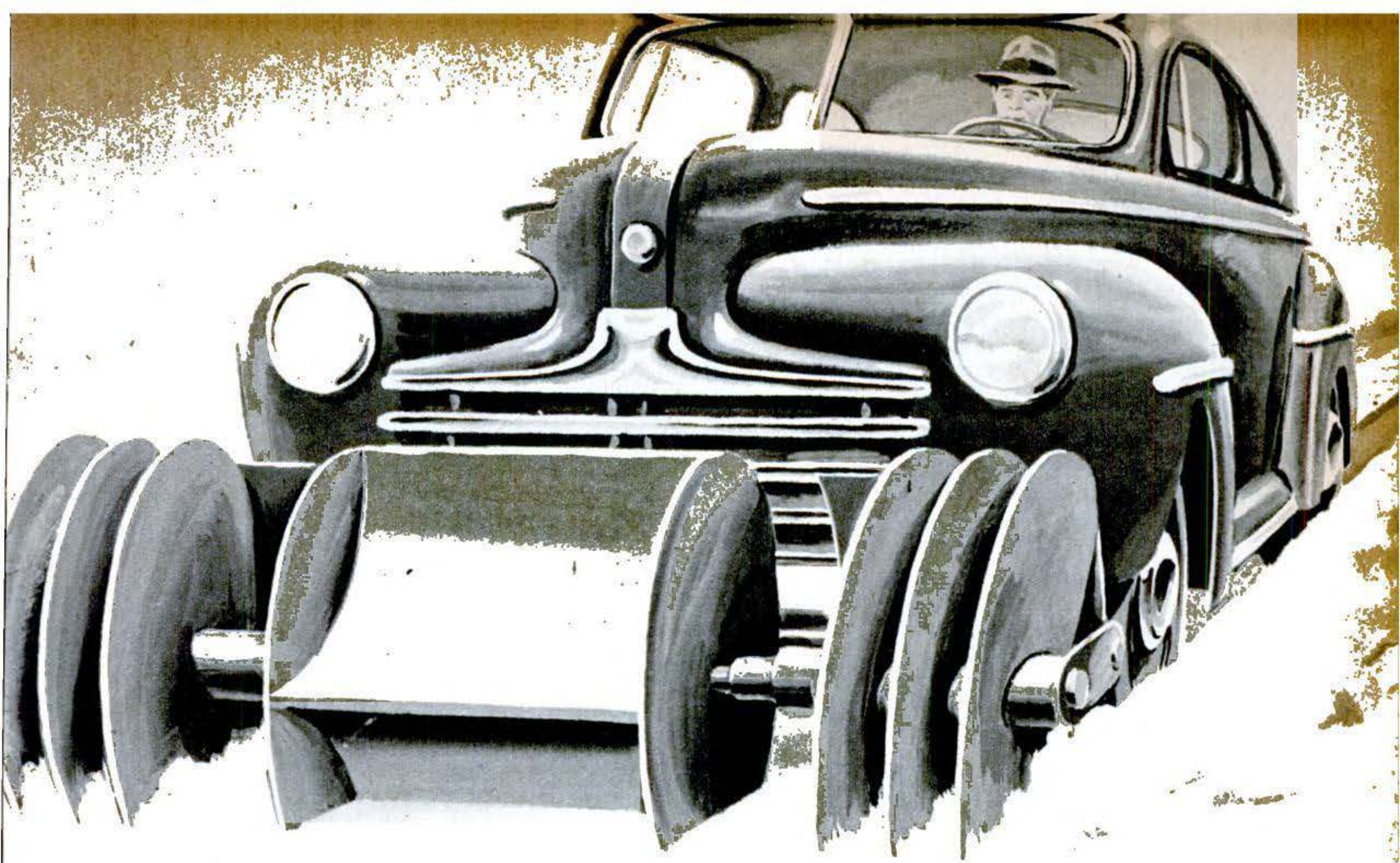

Car Pushes Its Own Plow. A small, lightweight snowplow that can be pushed by an ordinary automobile has been invented by Samuel Eliot, of Newton, Mass. Mounted on the front bumper, it has two

screwlike, spiral sections that keep pushing the snow to either side of the car, clearing two wheel tracks. Four blades in the drum in the center dig into the snow one after another and keep the plow rotating.

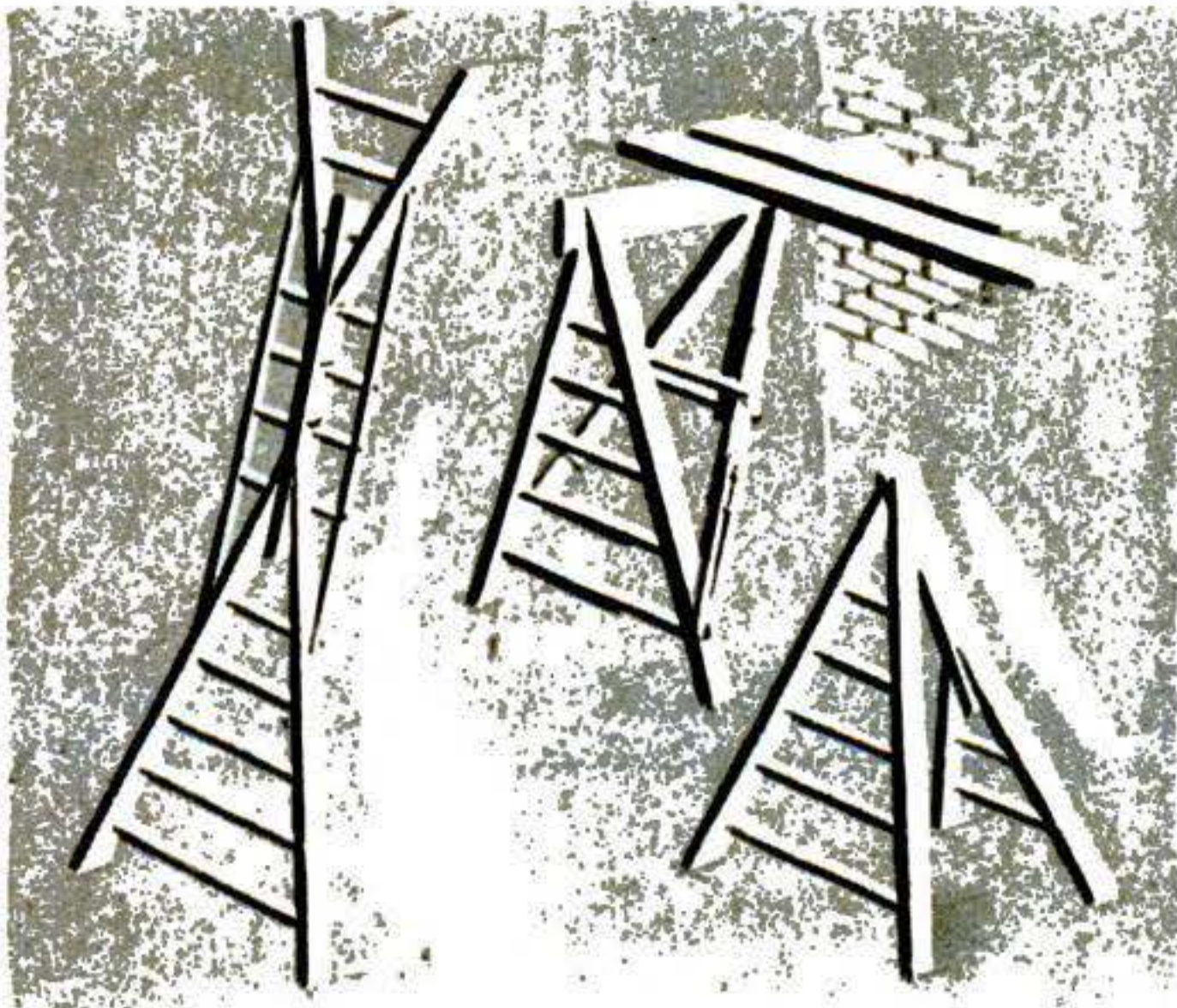

Ladder Has Several Uses. This novel ladder, formed of two V-shaped rung sections joined together by a pole, serves as a stepladder when folded in the middle. Laid out flat with side braces added to folding rungs in its central section, it becomes a straight ladder. Folded another way, it is a scaffolding support. It was invented by J. Anderson, of Vancouver, B. C.

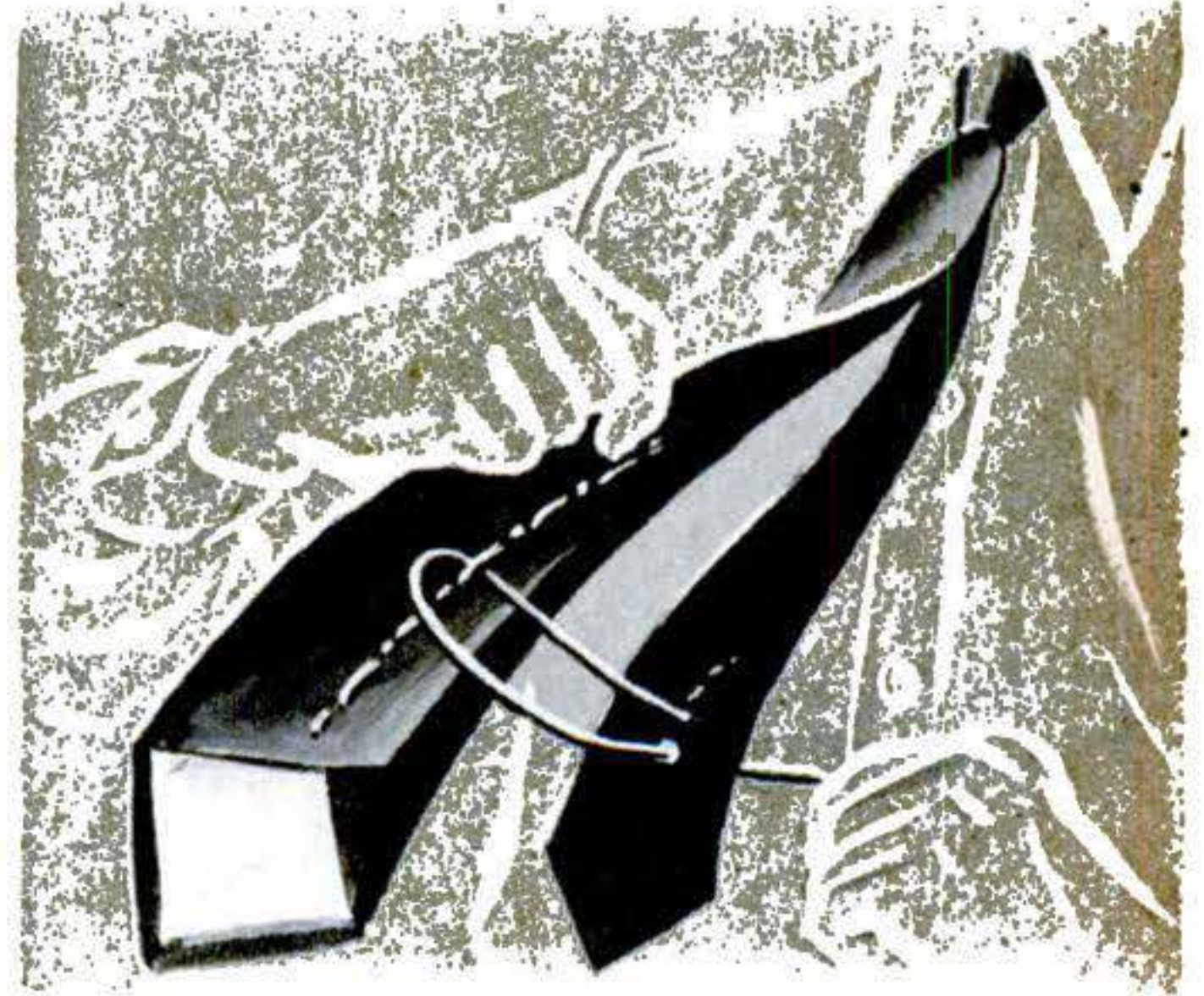

Tie Keeps Ends in Place. You'd never lose or forget the tie fastener patented by Joseph Johnson, of Islington, Mass.—it's sewed right onto the tie. Pulled through any one of a number of loops in the tie's longer end, a string attached to the shorter end is threaded back through a small hole and then wound around the nearest shirt button, holding the tie in place.

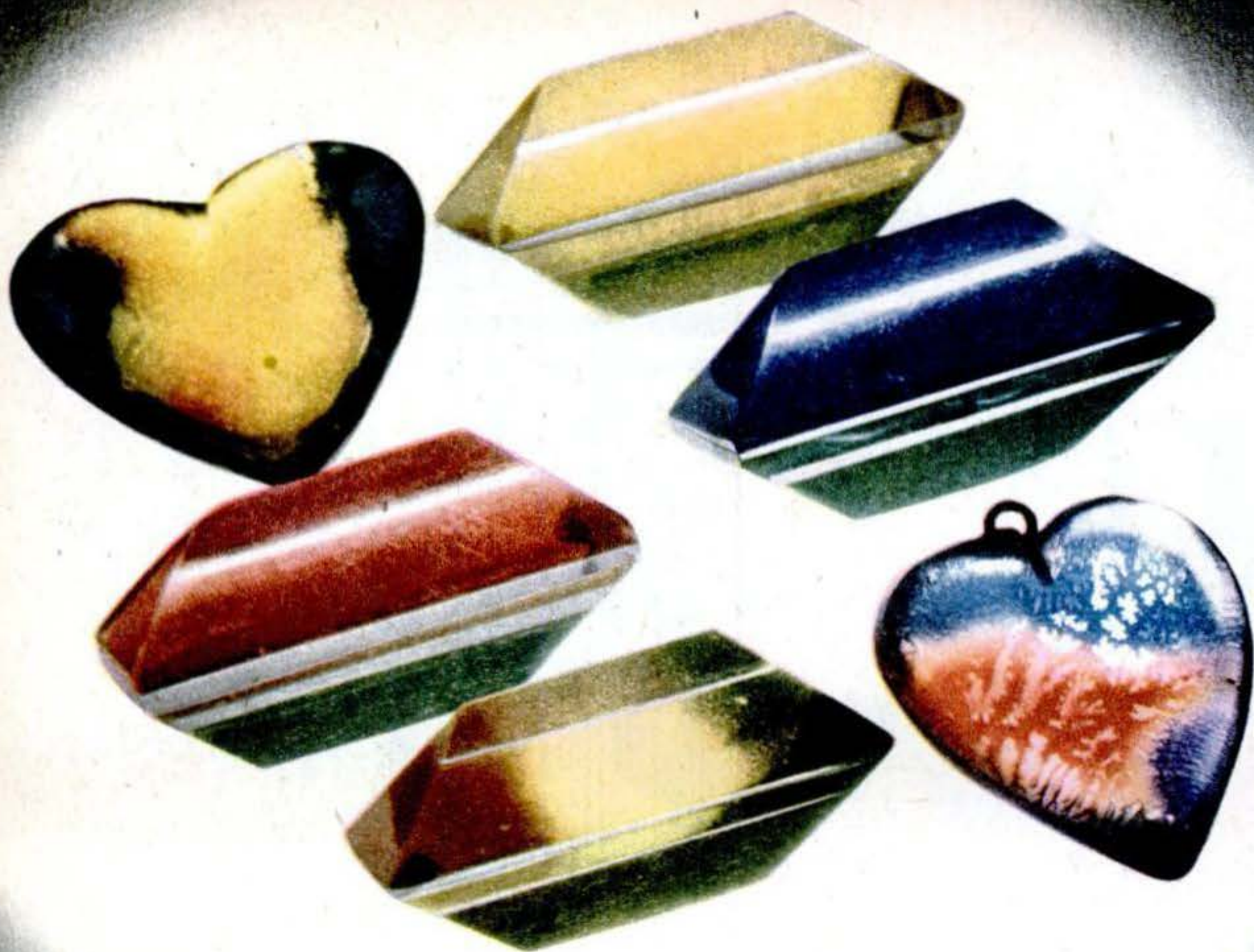

Hearts and diamonds in varied hues, as well as countless other ornaments, may be shaped from plastic laminated with colored cement. Sold in liquid form ready for use,

the cement is available in all basic colors. Like paint, two or more of these may be blended to make a desired shade. The heart-shaped pendant was made as shown below.

Using a brush, flow cement liberally over one face of a sheet of plastic, being careful to coat the entire surface. Cements of different colors will produce a rainbow effect.

Laminating is accomplished by placing another plastic sheet over the cement. Slide it about, pressing out air bubbles by squeezing. Work fast; the cement dries quickly.

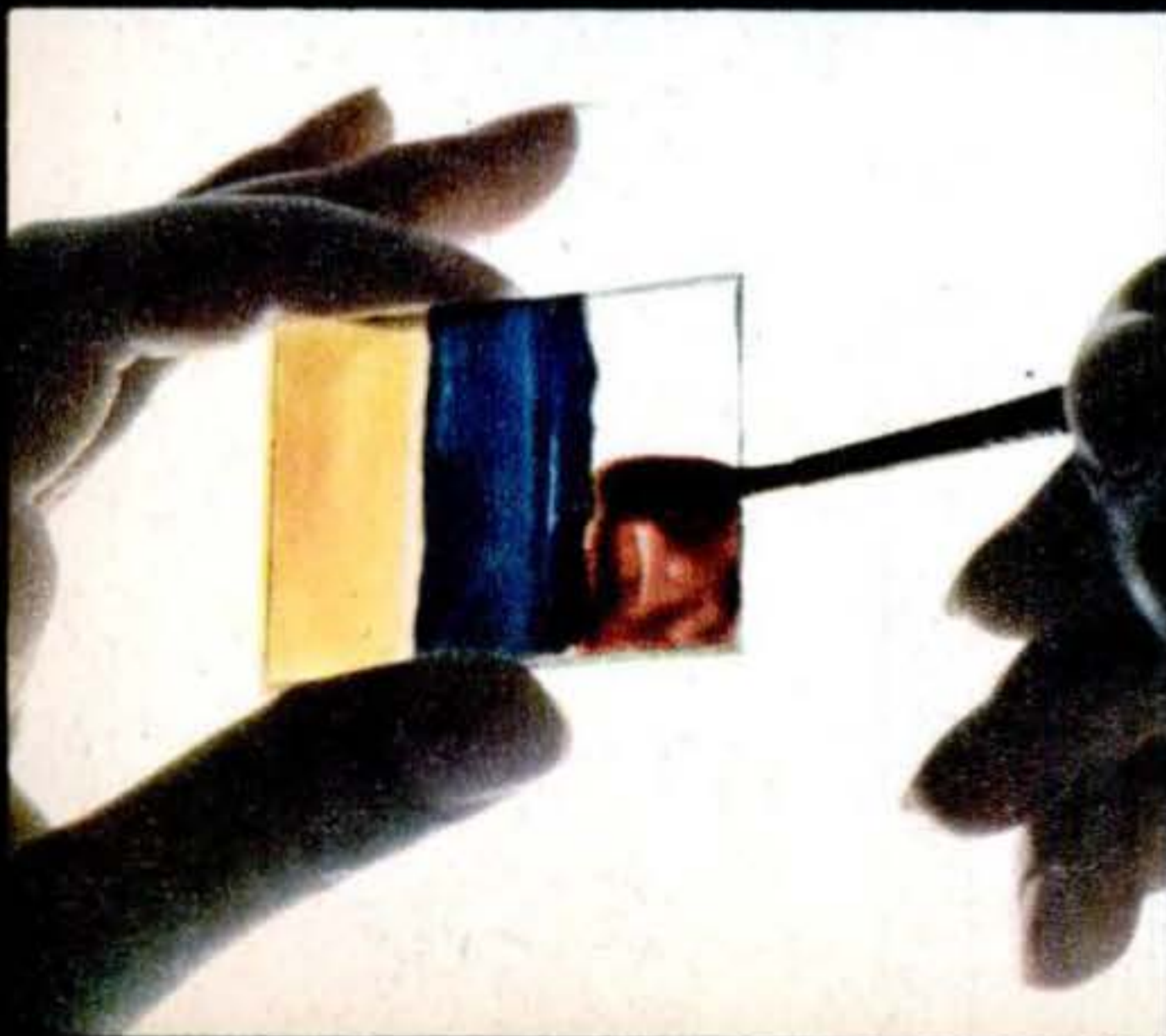

Laminated Plastic Works Color Magic

By Maurice Lannon

CEMENTS in various hues offer intriguing possibilities to the craftsman who works with plastic. Consisting of a dye in a plastic solvent, these cements are specifically intended for producing color in laminated sheets of clear plastic.

As a rule, the laminating should be done before any finishing operations, since the excess dye spills over the edges and must be sanded off. Apply the cement with a brush, flooding it on quickly so as to coat the entire surface liberally. Slide about the other sheet of plastic to blend colors and work out all air bubbles with finger pressure. Work fast, for the cement begins to dry in seconds. Solid colors may be used, or several may be applied in streaks or splotches.

If you'd like to duplicate the hearts pictured on these pages, laminate two 2" by 2" pieces of $\frac{1}{4}$ " or $\frac{3}{16}$ " clear plastic. Scribe the heart from a cardboard pattern, cut out with a hacksaw or coping saw, file to shape, and buff to a high polish. On a jigsaw, blade speed should be reduced, as fast cutting generates enough heat to weld the cut together.

In making your selection of colors, go easy on the blue and green. These colors are much stronger than the others and are apt to overshadow the reds and yellows.

Hacksaw the heart from the most colorful area of the plastic after scribing with a cardboard pattern. Rounded edges refract the light, making it colorful from any angle.

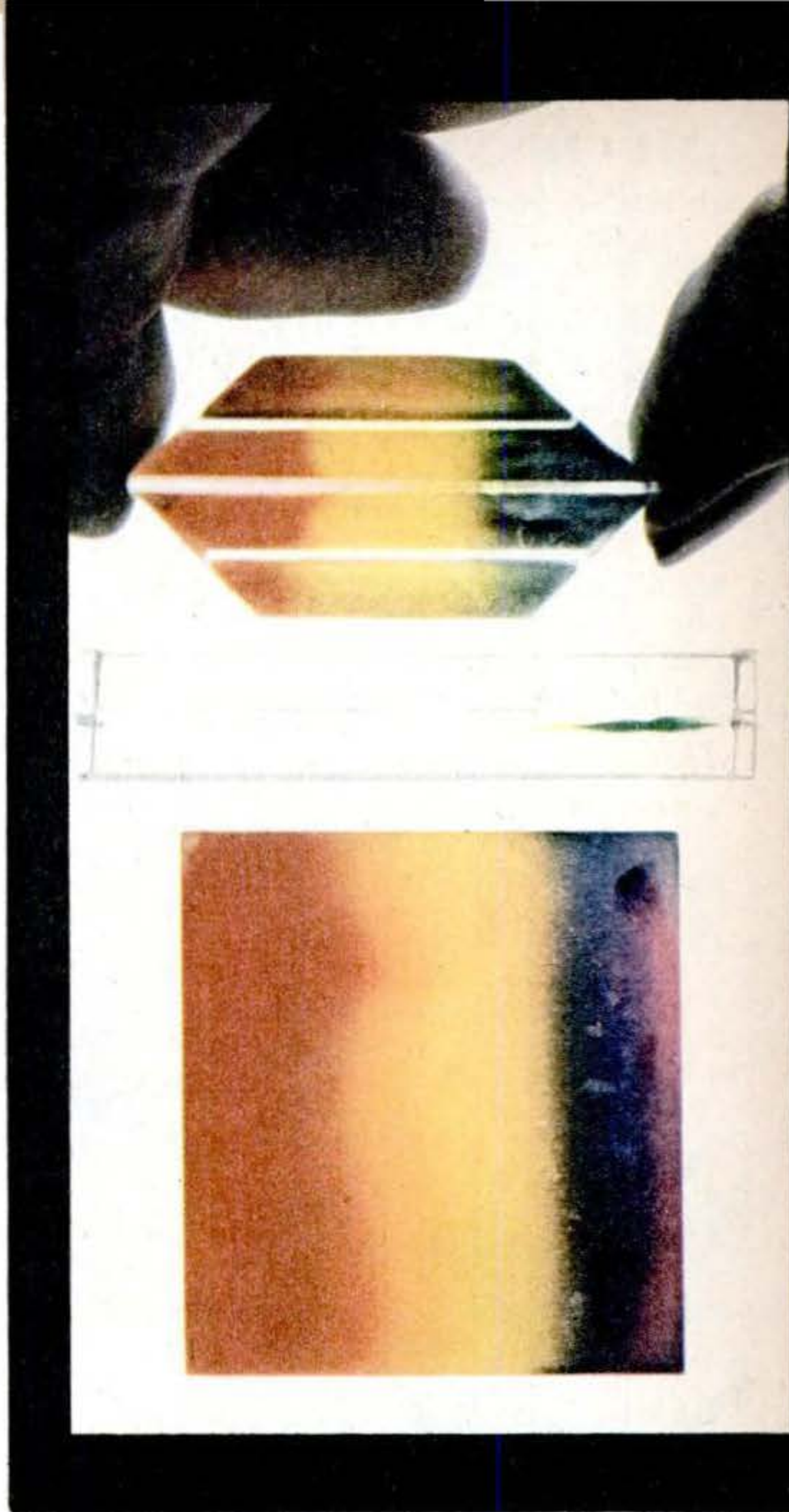

Refracted light adds to the beauty of plastic laminated with colored cement. Viewed edge on, the joint shows only as a dark line. But bevel the edges and the color appears.

Turn a screw eye into the edge for attaching a chain or cord. First, drill a hole slightly smaller than the shank of the screw eye, which will then turn firmly into the plastic.

DECEMBER 1947 133



MECHANICS OF LIVING

PSM photos by Robert F. Smith

YOU push down the handle, wait . . . and the bread pops up all by itself, toasted to a turn. Ever stop to wonder how the toaster knows enough to brown your slice without burning it?

Automatic toasters are mostly of two types—both ingenious. One has a thermostat that cooks with the toast and switches off the current after the right amount of heat. The other kind is timed by clockwork, but uses a thermostat to speed up the machinery when full heat is reached. Here is what goes on inside both types, shown in Toastmaster toasters through the courtesy of A. Lockyer of Toaster Appliance Sales and Service Co., New York City.

Thermostat-controlled automatic toaster.

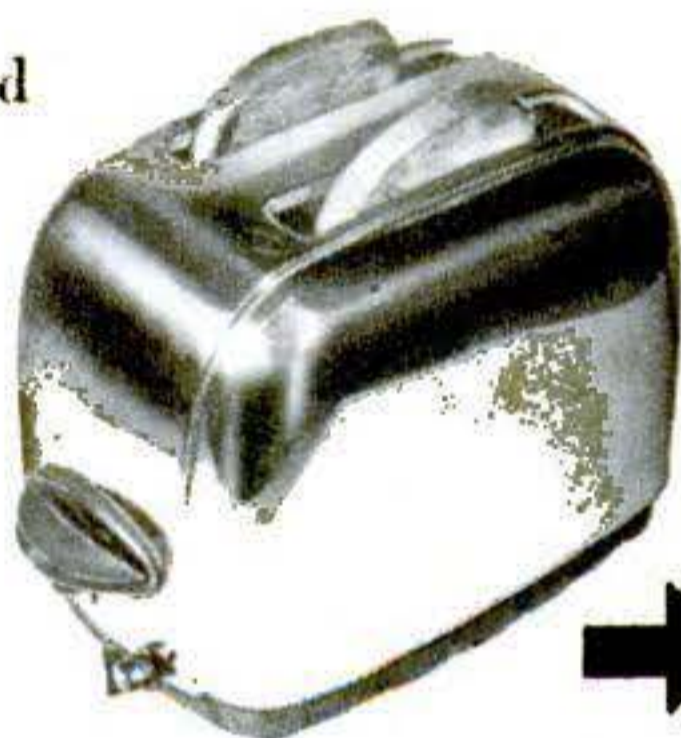

Thermostat- and clockwork-controlled toaster.

On this type, pushing down the big handle not only closes the switch but also winds up the clockwork timer and starts it ticking. Clockwork is in the box on far side, behind the hand. As in the thermostat type, the darkness control switch is at the lower right of the end of the toaster. The oven slides up and down on guide rods.

134 POPULAR SCIENCE

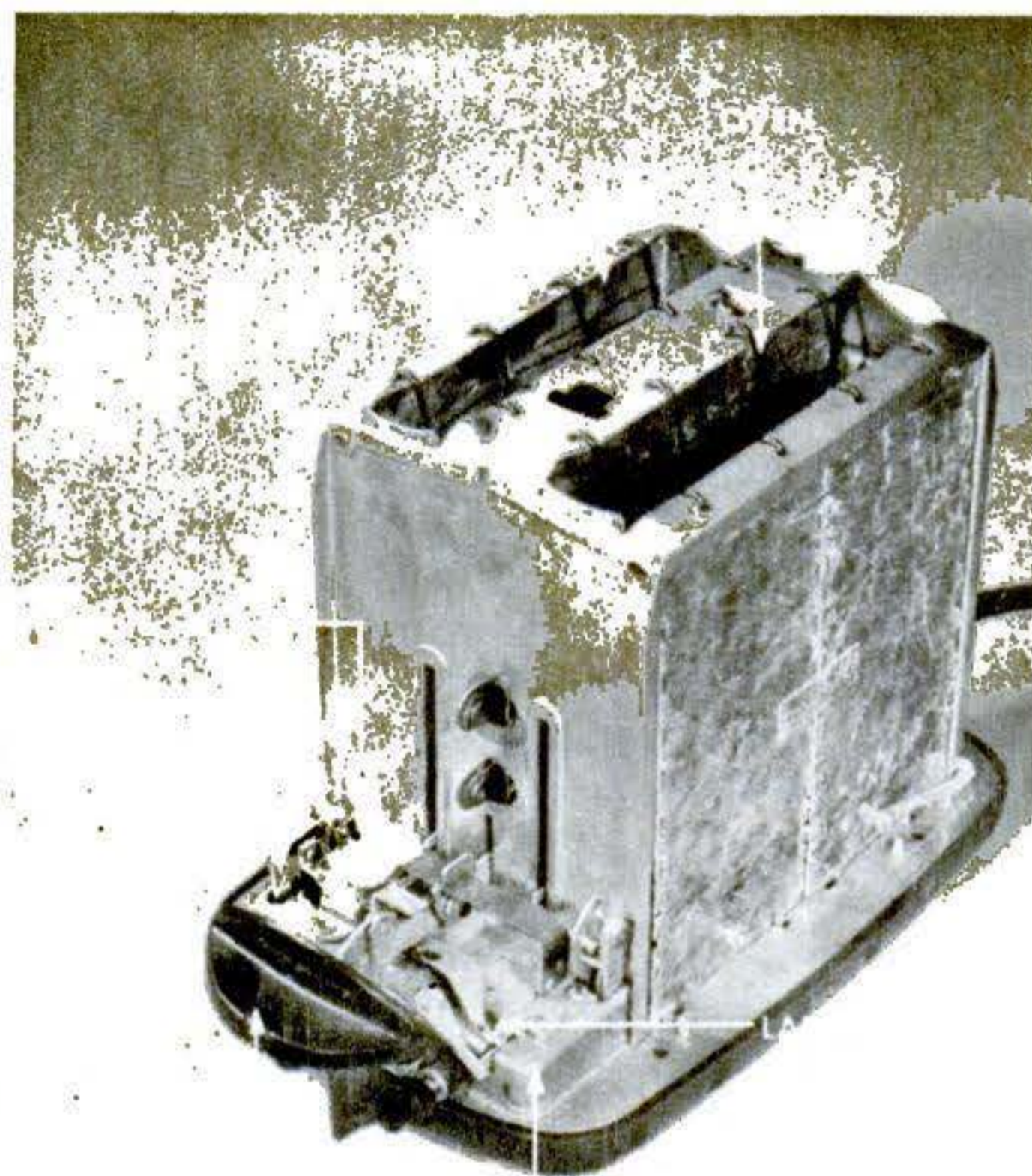
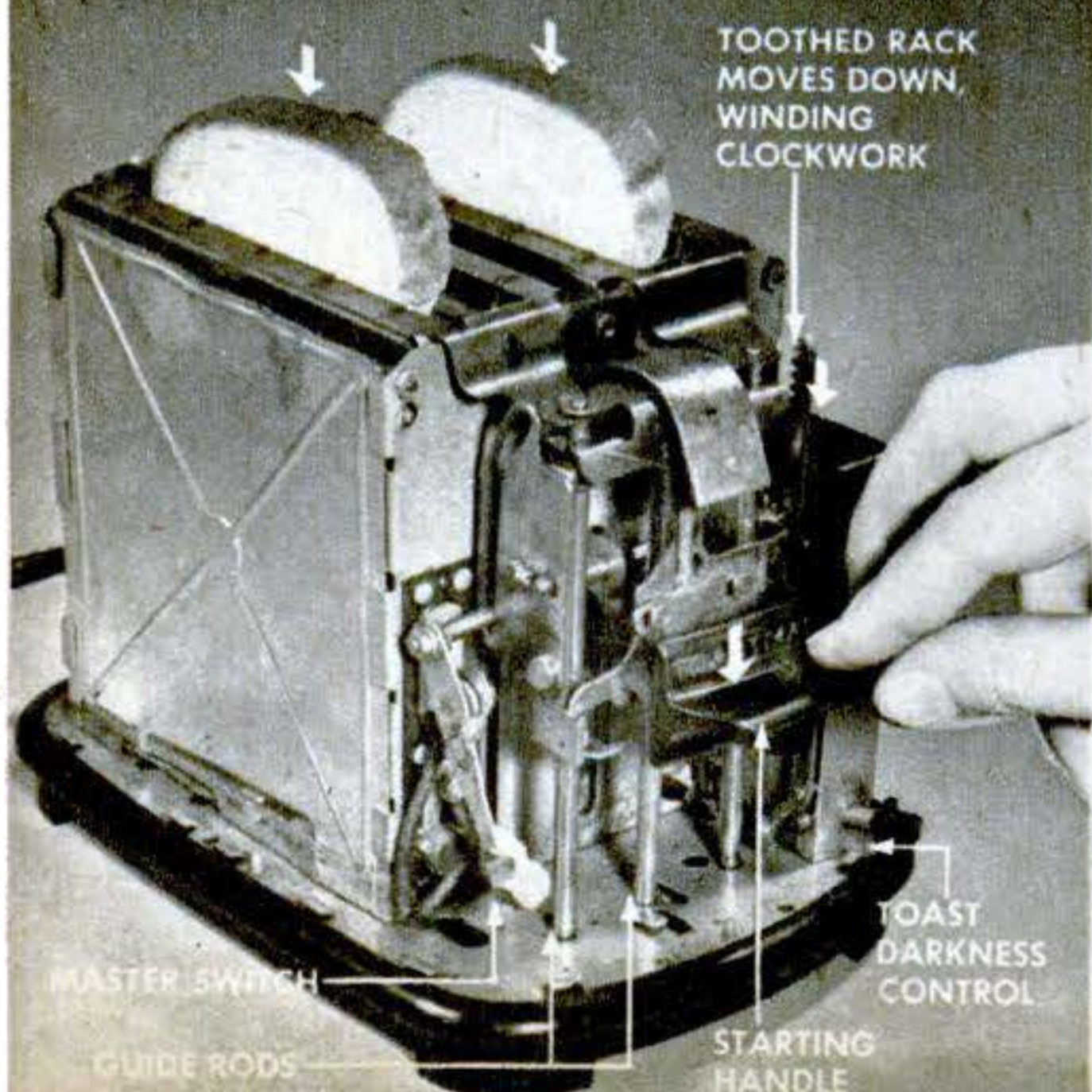

Here is a thermostat-controlled toaster just after the handle has been pushed down, dropping the bread carriage into the oven. This has closed the main switch, and both the toasting elements and the auxiliary heating unit around the thermostat have begun to glow. A latch holds carriage down against tension of the "pop-up" spring.

The latch grips the bread carriage in the bottom position, but the clockwork is slowly lifting the handle back to the top. With it a cam is rising toward the roller latch release that will pop up the toast. A thermostat under the toaster, shown in the next picture, is speeding up the clockwork as the toasting elements get hotter.

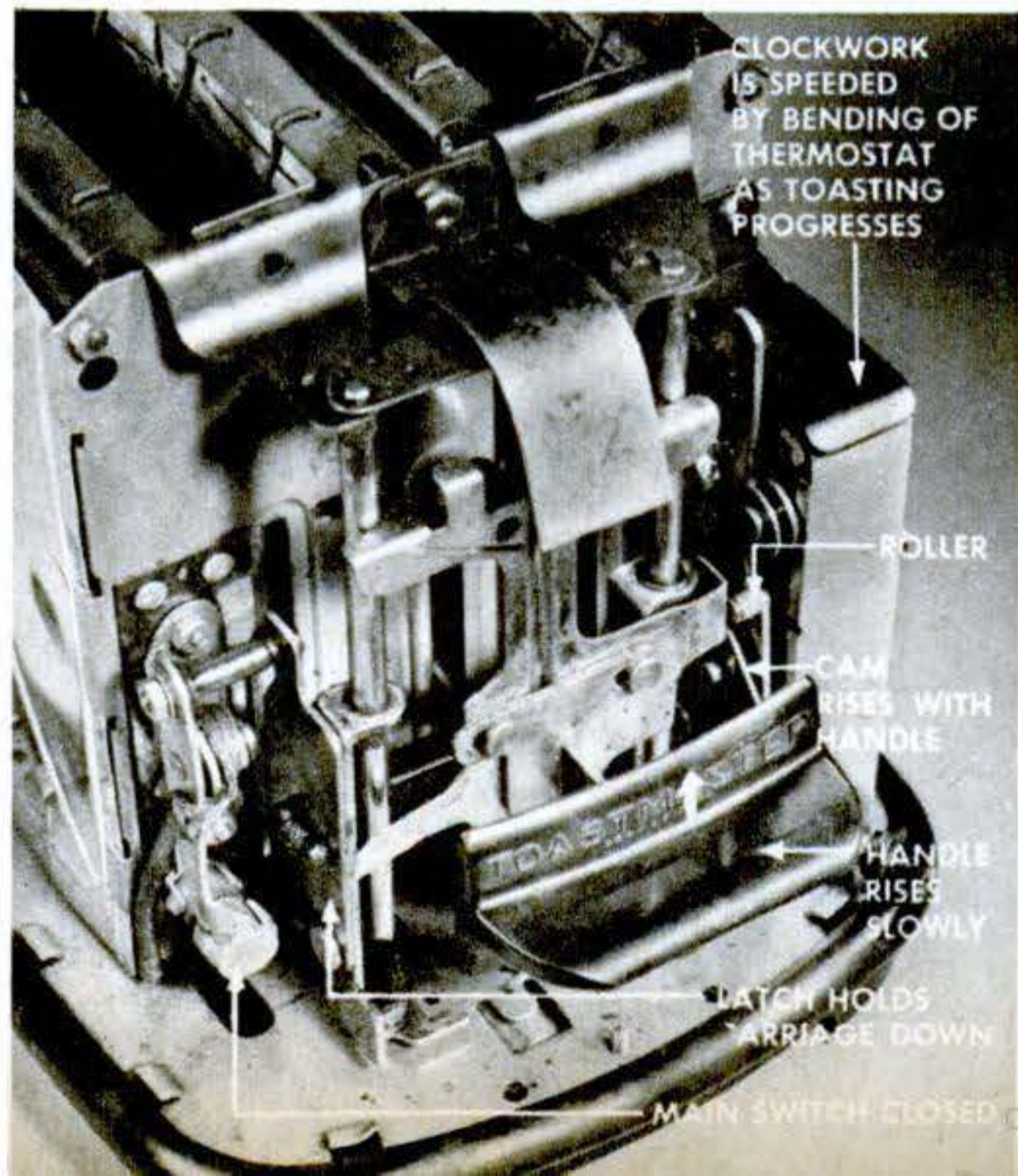

Automatic Toaster Works

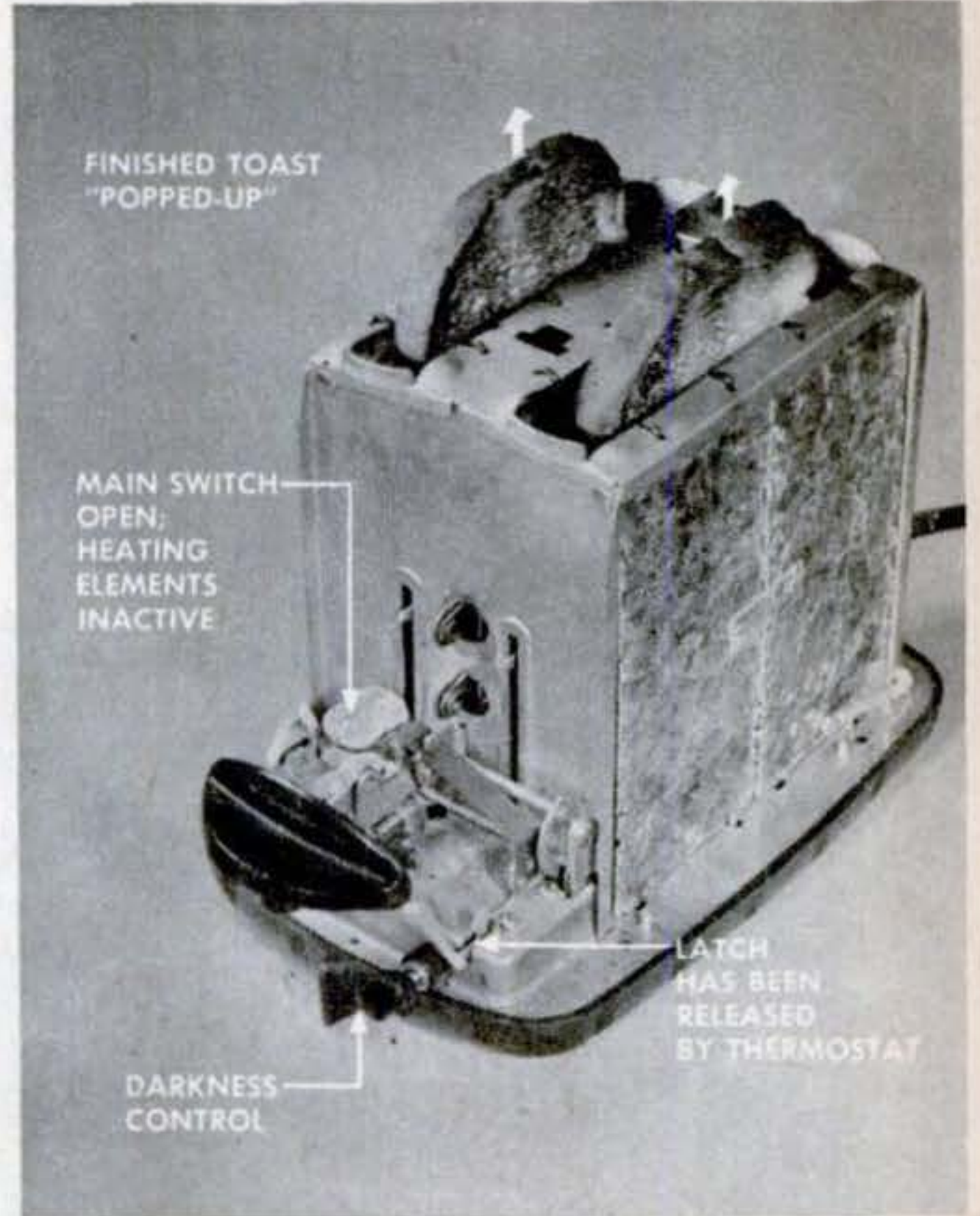
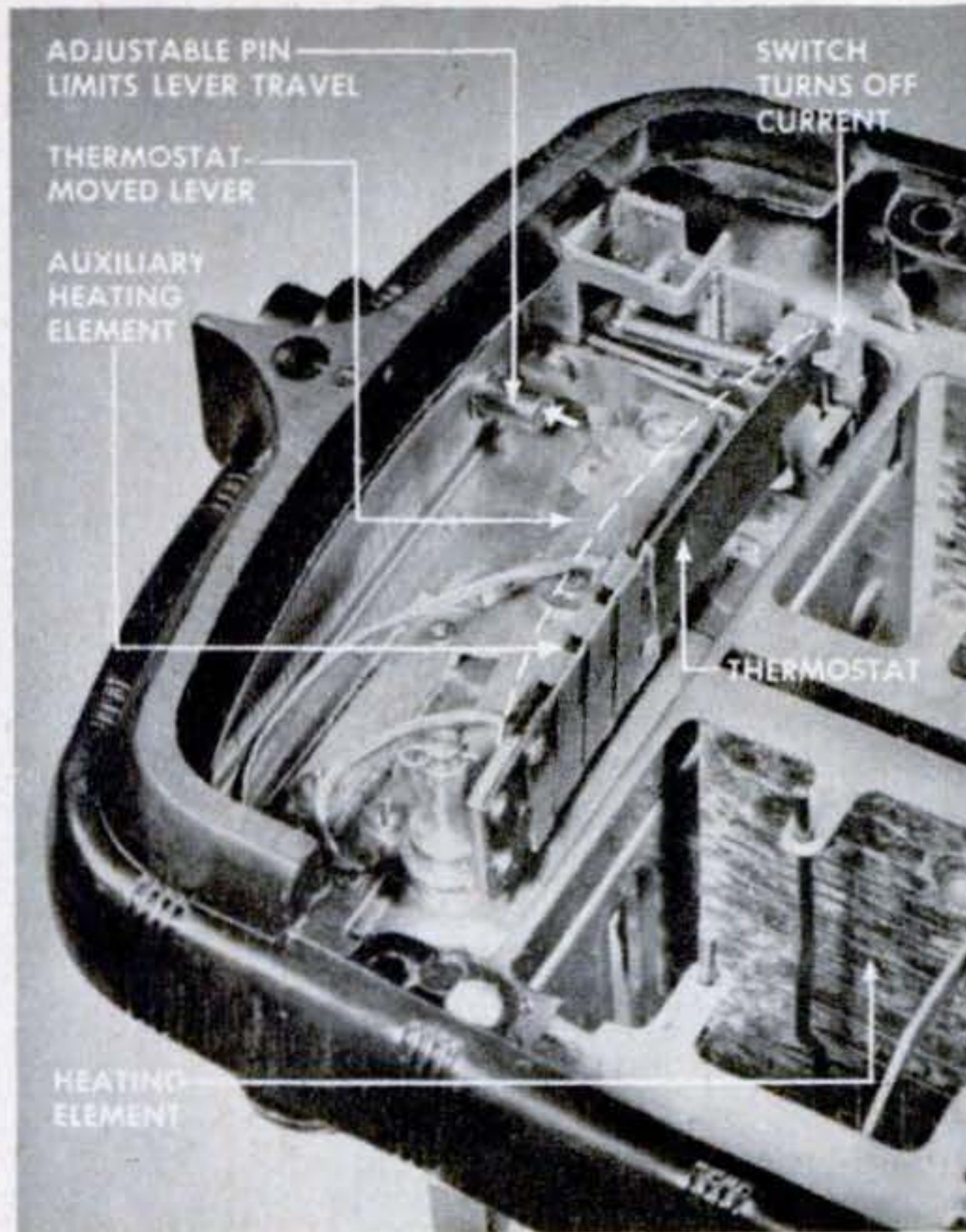

Removal of bottom plate of toaster shows thermostat bar wrapped in its own heating unit. As it grows hot, bar bends along dotted line, pushing lever beside it to left. When lever is stopped by pin, it halts movement of center of thermostat bar, but heat keeps bending bar, forcing its tip to the right. Tip pushes switch to shut off current.

As it cools, thermostat has straightened and released latch, allowing the carriage to pop up. The small control wheel on toaster end changes toasting time by pushing in or out the little pin that halts thermostat movement. Setting control at "light" pushes in pin so that it shortens time before thermostat tip bends, shutting off heat.

Removing plate from underside reveals bi-metallic thermostat, close to the left of the long "pop-up" spring. As it heats, the thermostat pushes the pin, just to the left of its lower end, that increases the speed of the clockwork. This enables the clockwork timer to allow for the varying efficiency of the heating elements as they heat up.

At end of cycle, the clockwork allows the cam to push aside the roller, just above the handle in the center of the picture. This releases the latch holding the toast carriage, and the "pop-up" spring forces it up. At the same time the master switch, at lower left, opens, shutting off the current to the heating elements.

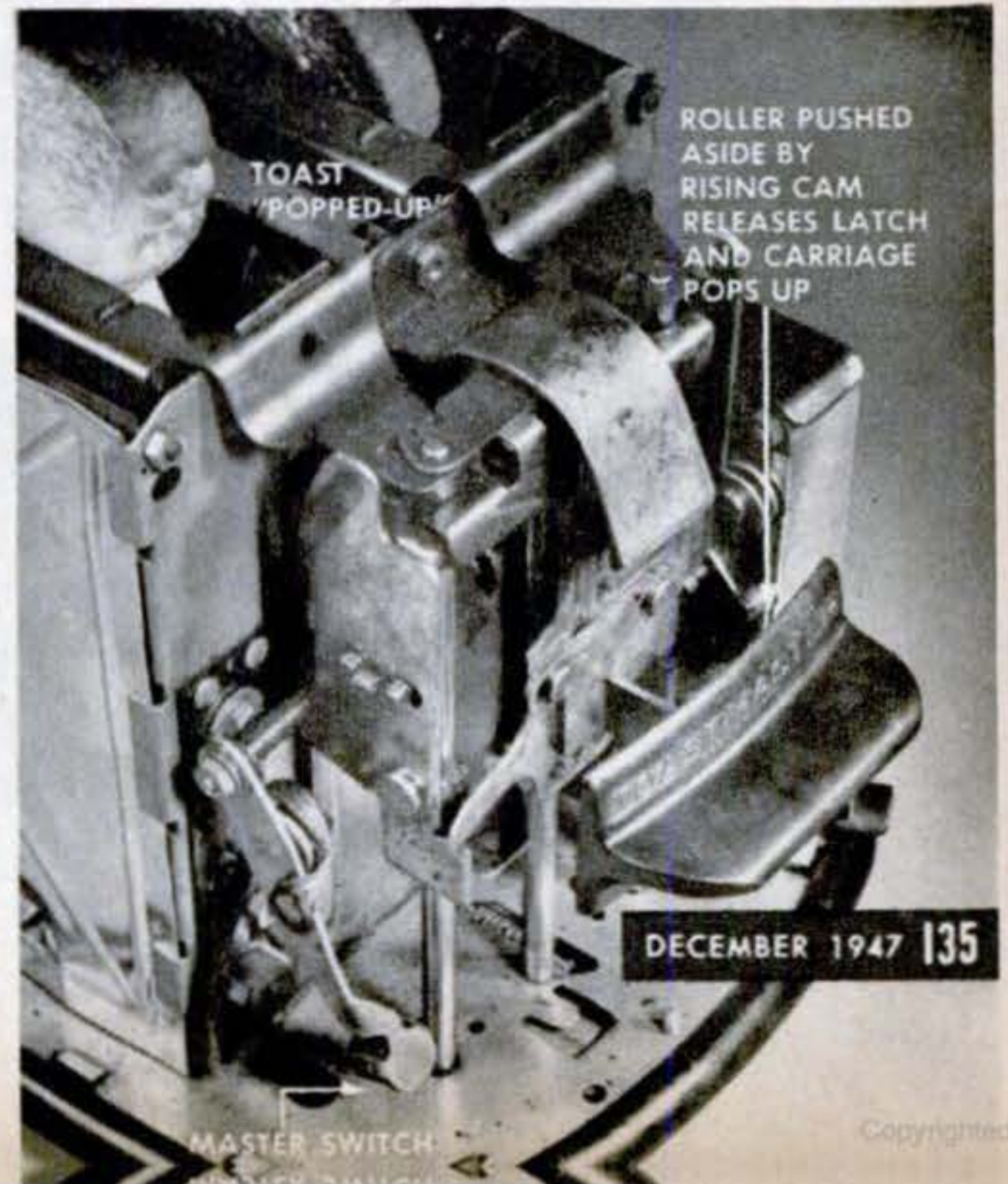
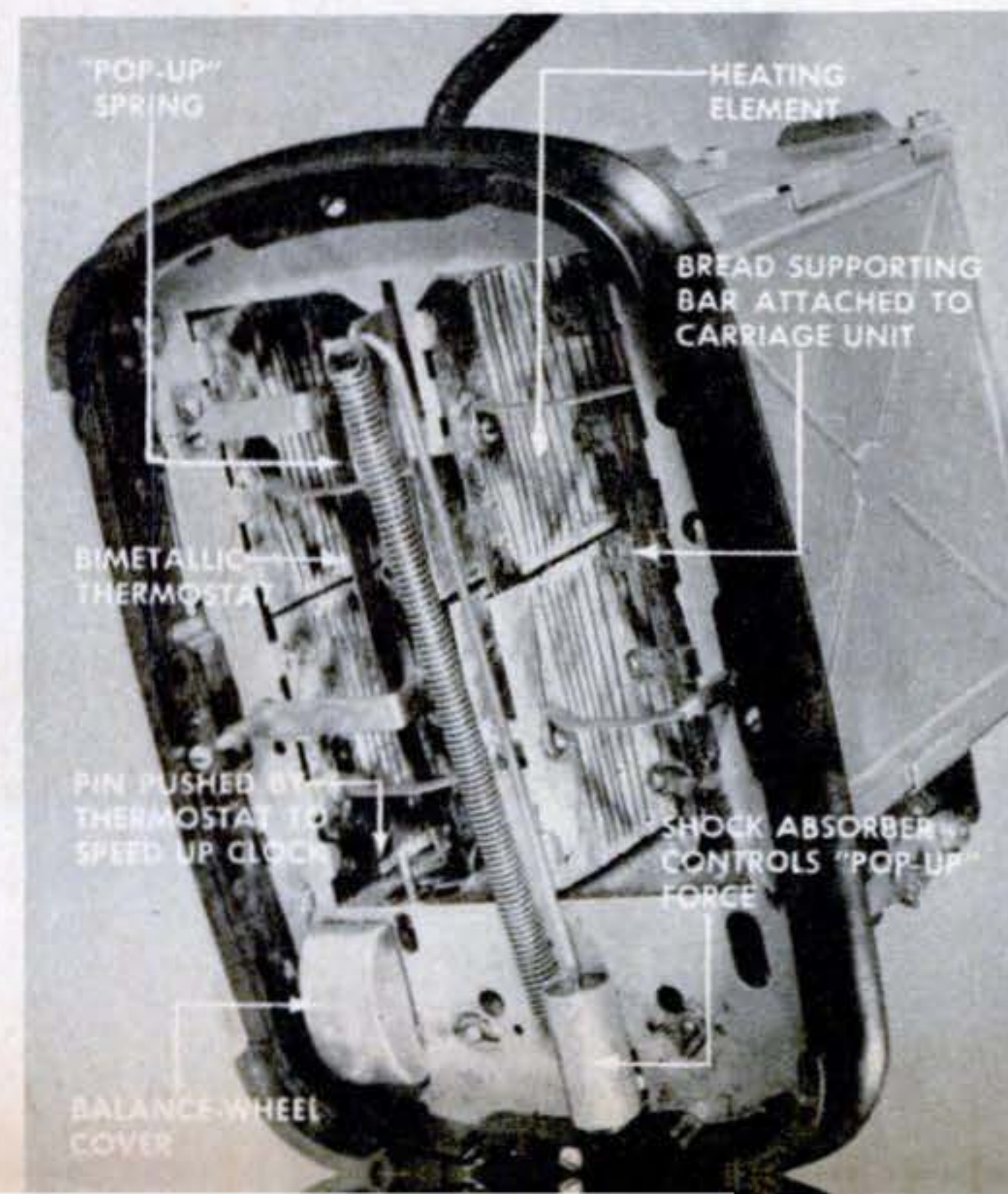





Real Planes Add Up to a Dream

DON'T let this odd contraption fool you. It's artist-flier John T. McCoy, Jr.'s idea of how a giant air liner the size of the B-36 might look. Despite its unconventional design, its features have all seen actual use in past or present aircraft.

The huge plane's canard, or "tail first," design places the passengers ahead of engine noise and fire hazards, and provides a

forward view unobstructed by a large wing. The bicycle landing gear saves weight, permits a thinner wing and helps eliminate gear failure, since the wheels retract into the fuselage and can be checked in flight.

Ex-Major McCoy, who has been flying airplanes since 1926 and drawing pictures of them even longer, has full confidence in the flying ability of his creation.



1 The retractable nose glass is borrowed from Republic's Rainbow. It uncovers conventional-type, flat windshield for undistorted vision during landings and take-offs.



2 Canard placement of wings harks back to the early efforts of the Wright brothers. It was used more recently on such experimental planes as the Curtiss XP-55 Ascender.



3 The bicycle landing gear, another old-timer, turns up again on the new Martin XB-48, as shown above. McCoy's use of it also includes the small outboard balance wheels.



4 Pusher-type tail props of the Langley are combined with wing-mounted jet engines as on this Douglas Mixmaster. The counter-rotating props reverse for braking and backing.

Think You Know

It takes 1,200 kinds for the many uses of nails;

By William P. Vogel, Jr.

PSM photos by W. W. Morris

1. Escutcheon Pin
2. Round Wire Spike
3. Metal-Lath Nail
4. Hoop Fastener
5. Barbed Dowel Pin
6. Roofing Nail
7. Nonleak Roofing Nail
8. Ribbon-Wire Staple
9. Fence Staple
10. Common Brad
11. Flooring Brad
12. Common Nail
13. Duplex-Head Nail
14. Round Dating Nail

TODAY the lowly nail is just as hard to come by as an automobile—for about the same reason. Demand far exceeds supply. Not only is building booming, but the nail is the end product of a long, complicated, steel making process. Nails must compete for raw materials with a host of other products. So even though steel men shipped 422,500 tons of nails last year, and are topping that record this year, you may still have to hunt quite a while for the right nail to mend your roof.

Colonial farmers hand-forged their nails during the long winters. Nails then were prized possessions, hoarded and straightened for re-use, often spent as money. Later, cut nails were made by machine, and since 1850 wire nails have been cold-drawn. Increasing mechanization has made nails more highly specialized, until today

The long and the short of the nail business are shown at left—a big boat spike with a tiny escutcheon pin on its head. Below are some representative in-between types.

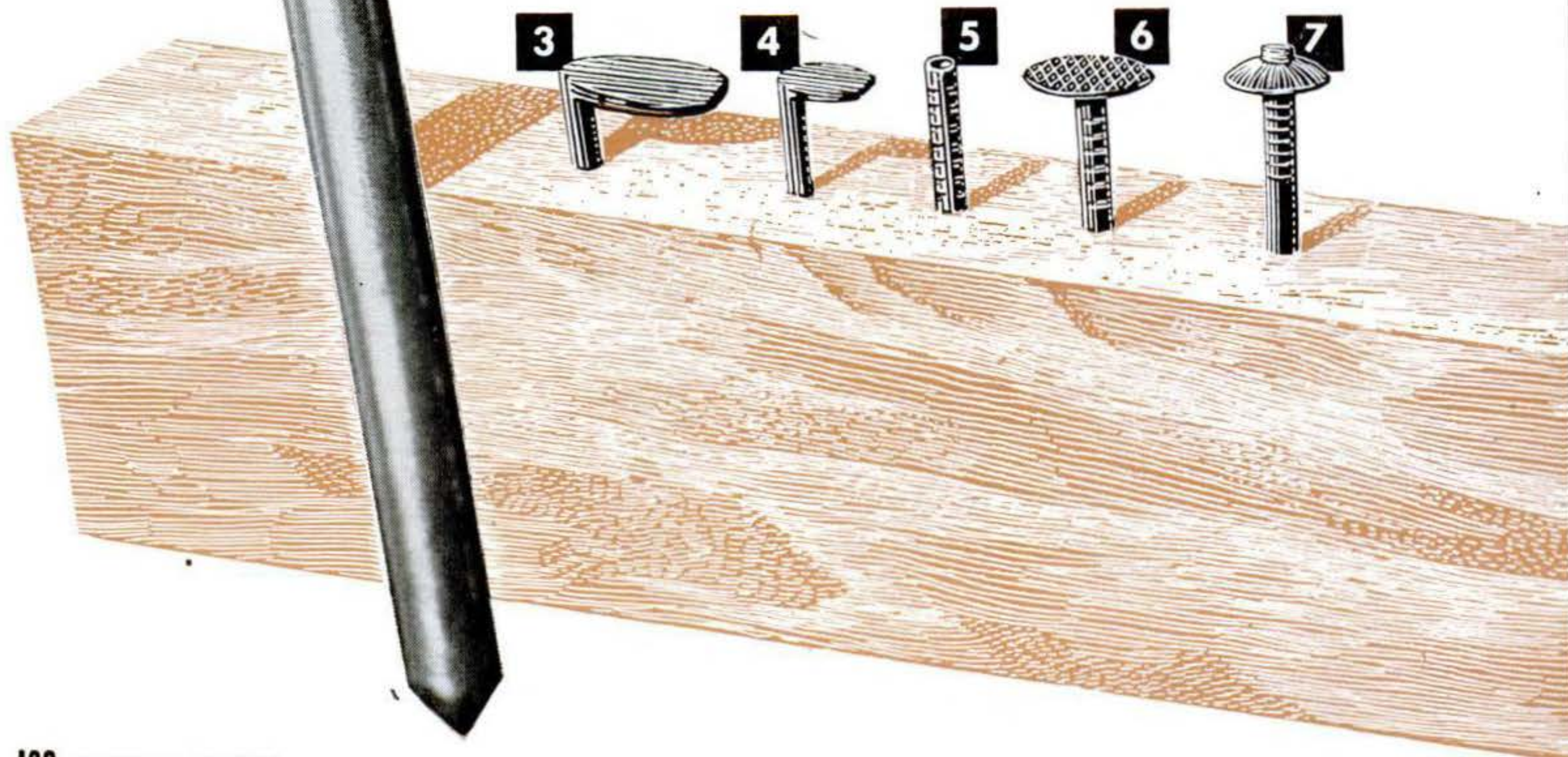

Nails?

here's how they are made.

more than 1,200 species of nails are produced for as many different, distinct uses.

They range from 15-inch boat spikes, weighing 1 lb. 10 oz. each, to 3/16-inch escutcheon pins, fine as a needle, running 95,000 to the pound. In between lie all kinds of nails, including the common bright ones in sizes from 3- to 20-penny,* most widely used for housing and general purposes. There are barbed nails and cement-coated nails for jobs where extra holding power is required, as in making boxes and trunks. There are leakproof roofing nails, with a perfectly flat head surmounted by a tiny boss so that the hammer blow will not deform it. There are special precise brads with sharp diamond-shaped points for automatic flooring machines. Sterilized nails, with a characteristic blue color, are made for the benefit of lathers who put them in their mouths. Corrugated nails are popular where the hammer head might slip. There are special nails for gypsum board, egg

*One theory holds that in England nails were once sold by the penny; hence, a 10-penny nail was the size of which 100 cost 10 pence. An equally tenable idea is that 1,000 10-penny nails used to weigh 10 pounds, 1,000 16-penny nails, 16 pounds, etc. Whatever its origin, the penny system is now universal.



Here are steel ingots waiting to be made into rod, wire, and nails. Each 25- by 30-inch ingot is seven feet long, weighs six or seven tons.

crates, berry boxes; there are dating and marking nails, and even nails with two heads, one below the other, to make it easy to pull them out.

Let's take just one group of nails—wire nails—and see how they are made. First, just any steel won't do. Nail steel must be worked both hot and cold. It can't be too soft or too hard. It must not oxidize too



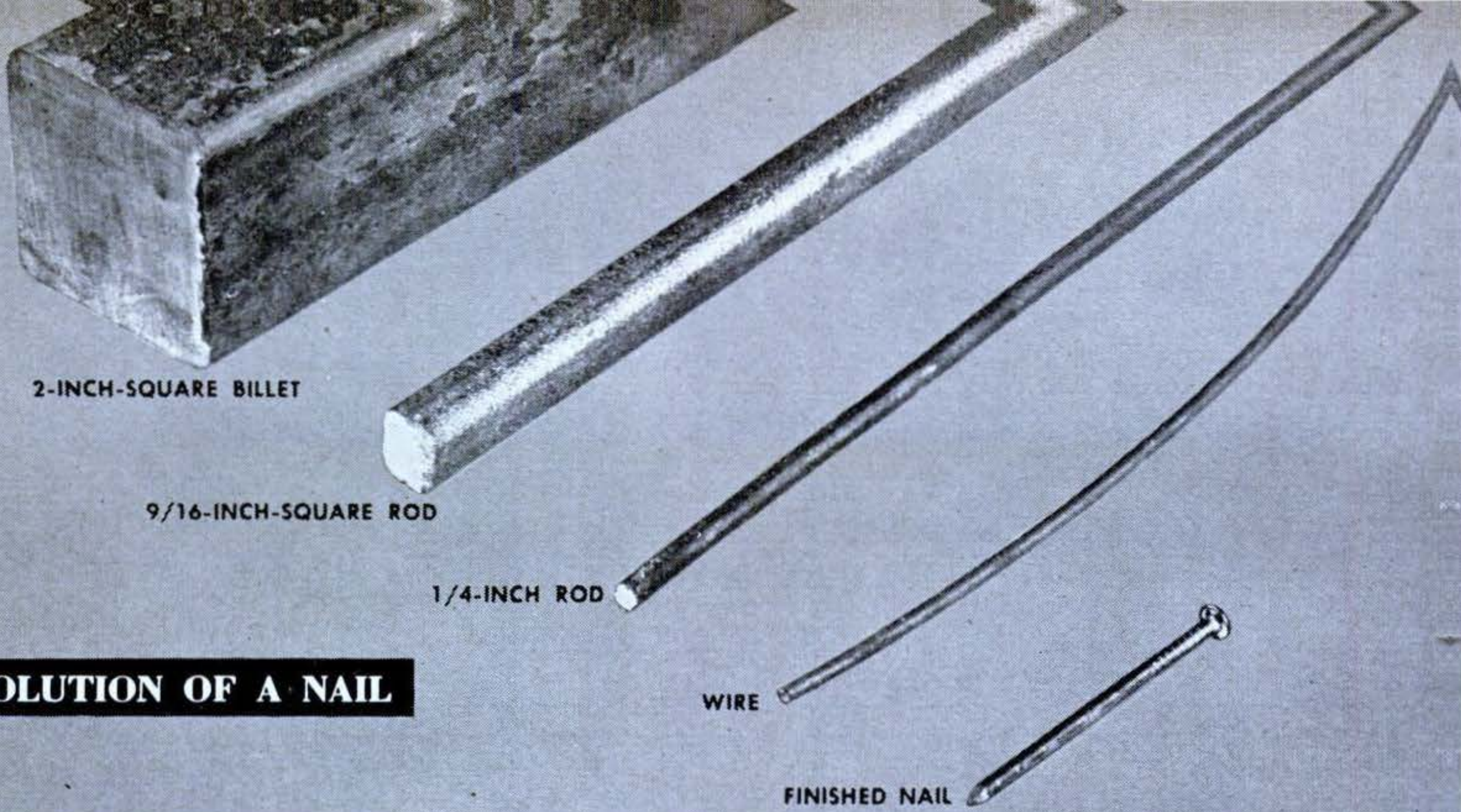

2-INCH-SQUARE BILLET

9/16-INCH-SQUARE ROD

1/4-INCH ROD

WIRE

FINISHED NAIL

EVOLUTION OF A NAIL

From billet to finished nail, the steel passes through the stages shown above. Previously, the big seven-ton ingot had a seven-minute workout

in the blooming mill. There it first became an eight-inch-square bloom, 50 feet long; then a four-inch-square billet, 227 feet long.

MAKING A BILLET

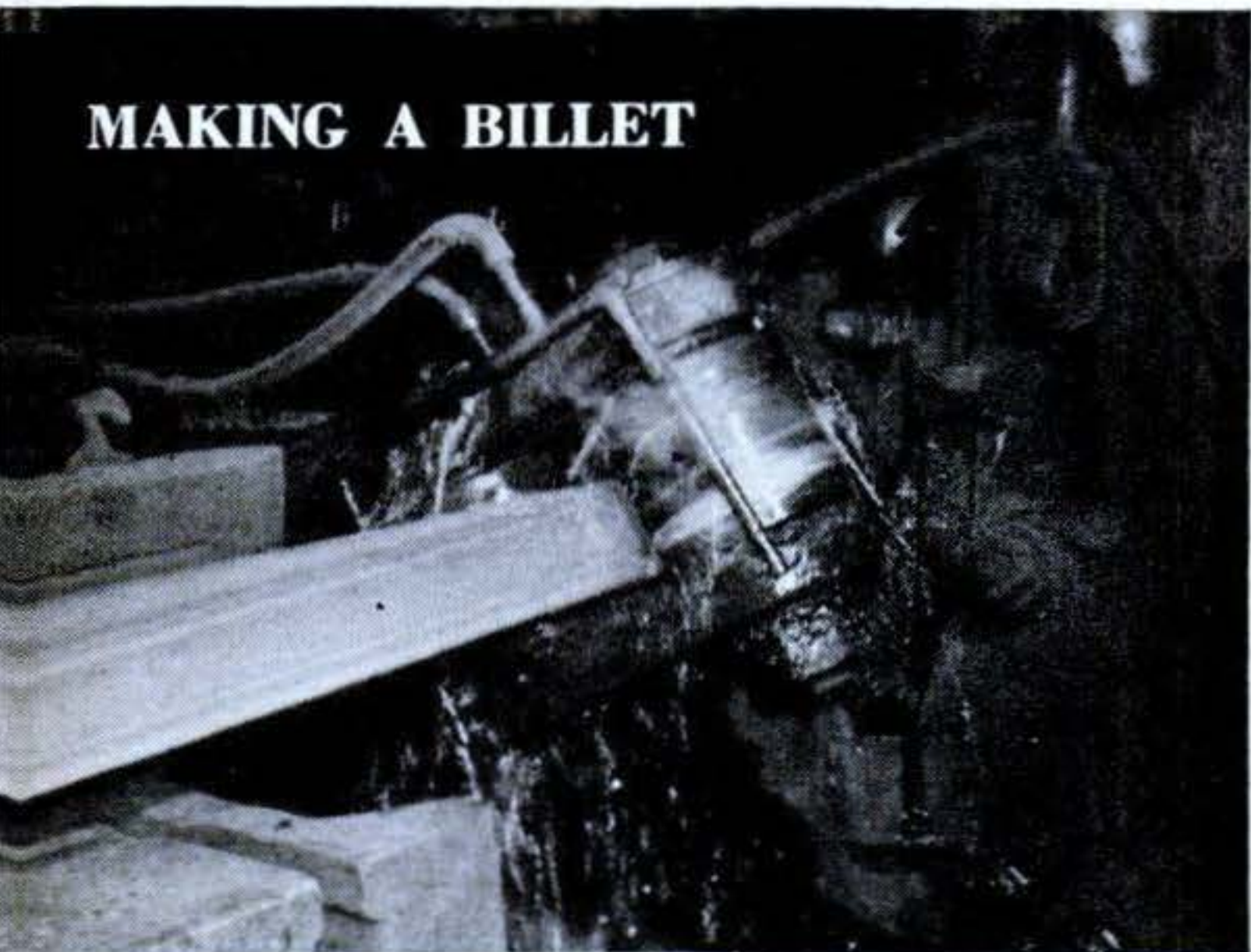

Eight-inch-square bloom becomes a four-inch-square billet in this mill. Here bloom passes through the fifth stand. In process it is twisted three times for good grain and structure.

In a reeking, noisy pit, steel rod is reeled after leaving finishing mill at 40 m.p.h. Over entrance of intensely hot pit, operator has scrawled: "Have you visited Hell's Kitchen?"

DRAWING ROD

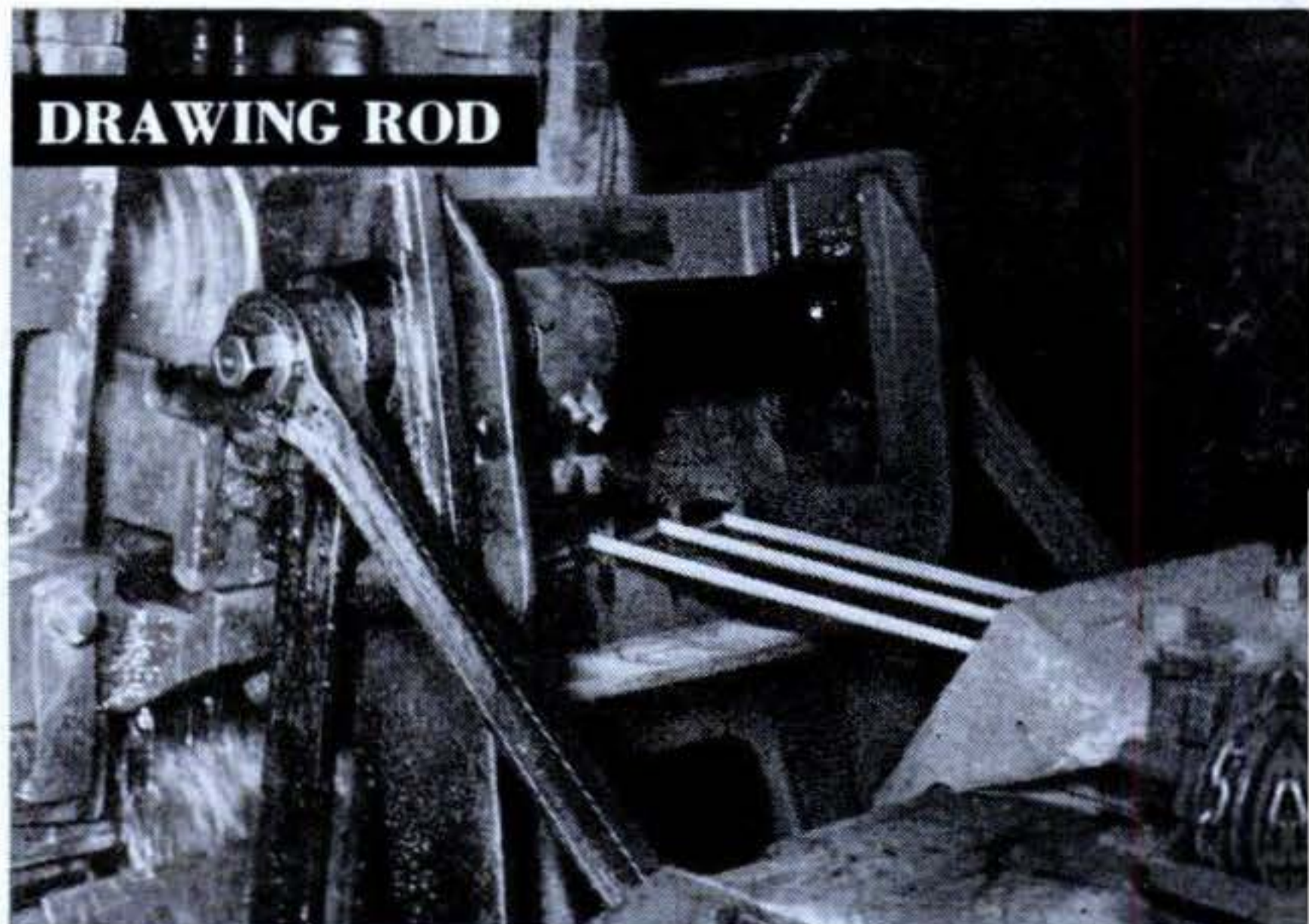

A **9/16-inch-square rod** leaves the roughing mill. The rod, roughly diamond-shaped, is moving about 8½ feet a second as it passes through a flying shear that crops off the damaged ends.

After cooling, the 400-lb. rod bundles are picked off onto a hook conveyer, inspected, and labeled to show hearth and heat numbers. Steel never loses its identity in entire process.

TREATING ROD

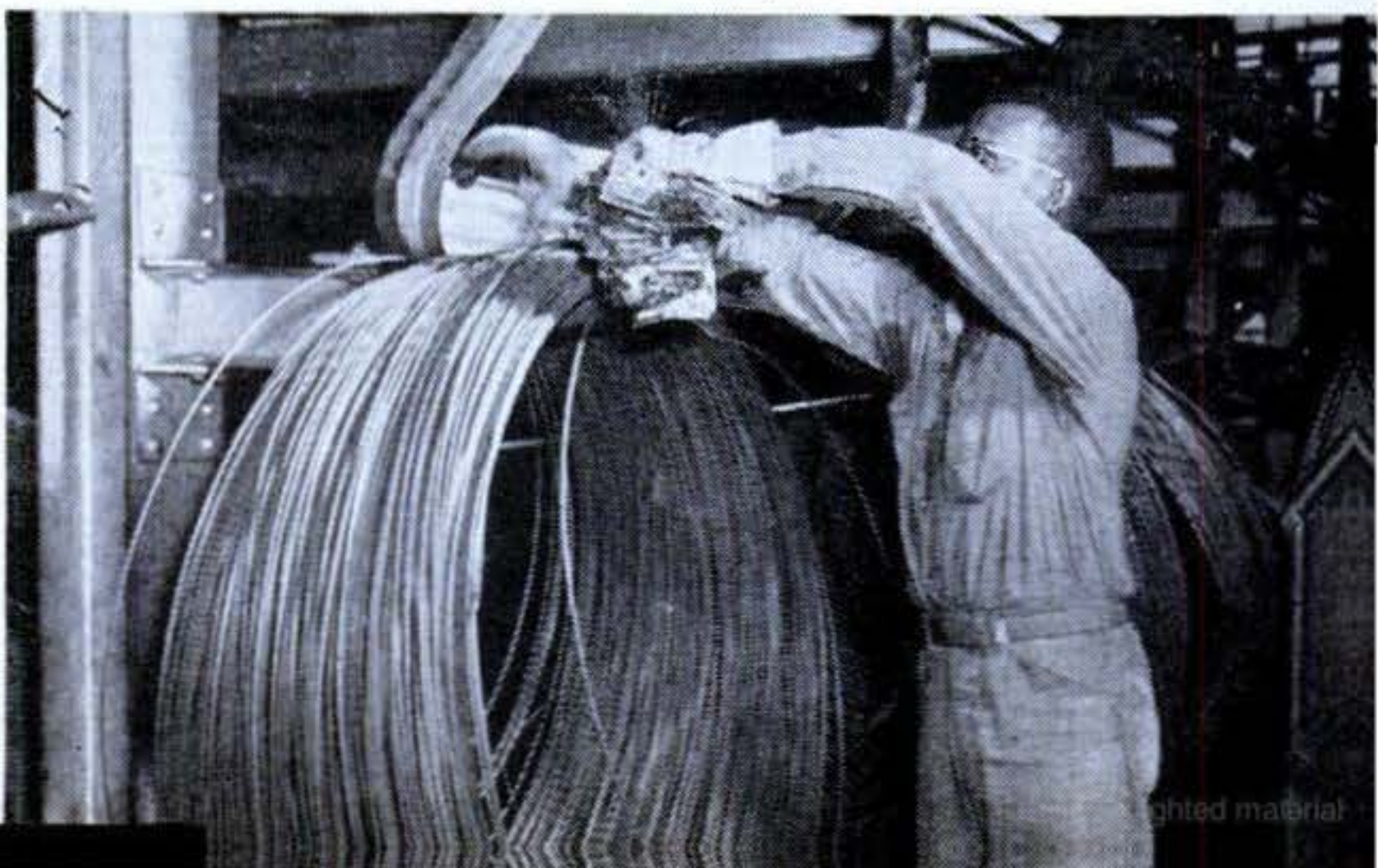
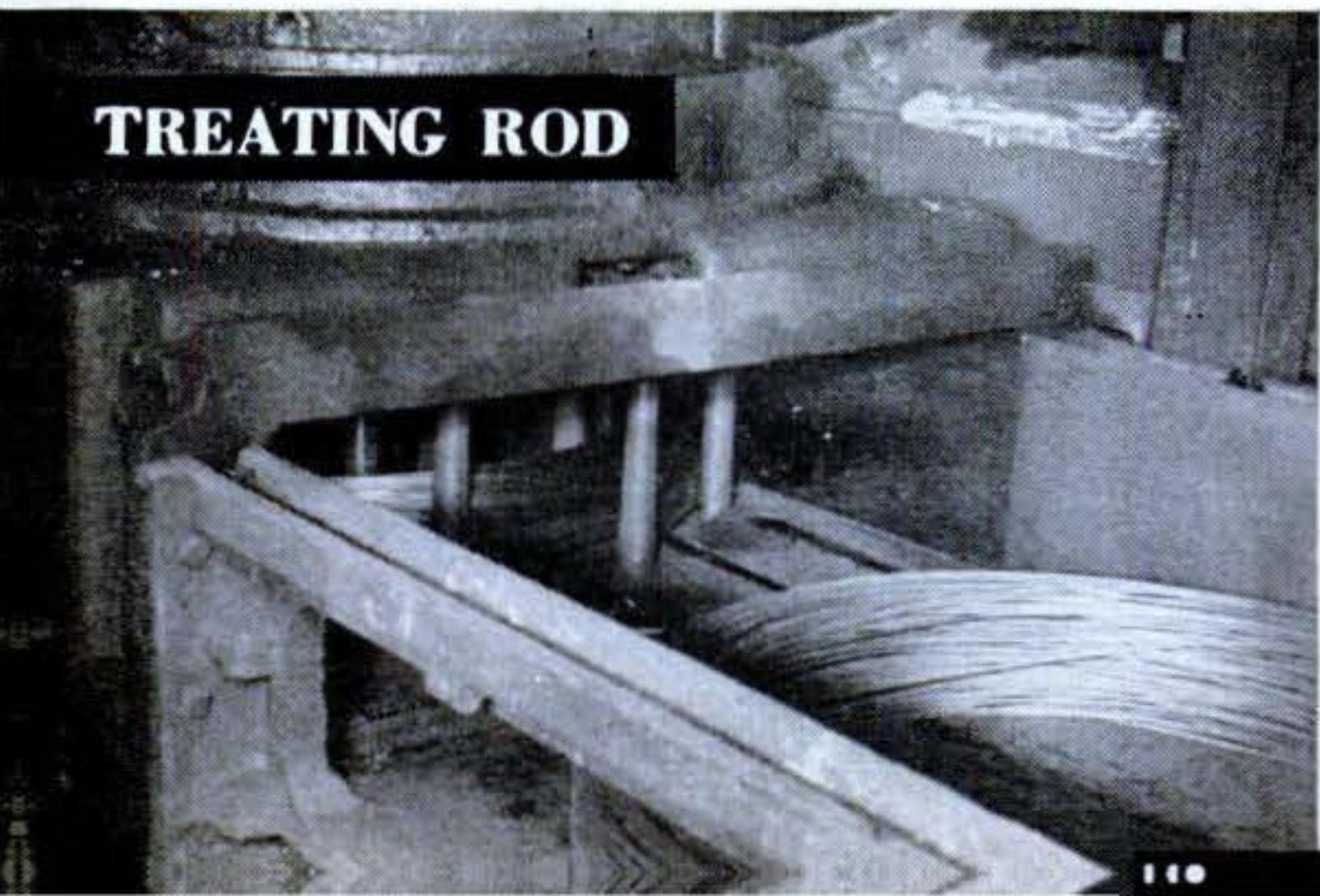

rapidly during milling. Most wire nails are made of good low-carbon steel, relatively free of phosphorus and sulphur.

In the huge Sparrows Point plant of the Bethlehem Steel Co., near Baltimore, the steel is made from Chilean ore, West Virginia coal, and Pennsylvania limestone. A "heat" of steel, generally 175 to 200 tons, is ladled into molds that form seven-ton ingots. As it rolls into the blooming mill, each ingot is almost white-hot, crusted heavily with scale that it has acquired en-route. The job of the mill operator is to reduce the ingot to a "bloom" 50 feet long and eight inches square. Because rolling deforms the ends of the bloom, it is cropped fore and aft by a powerful steam-driven, up-cut shear after it has been reduced.

The eight-by-eight bloom is run through the big rollers 15 or 20 times. Here it is squeezed through six stands of a smaller rolling mill that leaves the billet 227 feet long and squared off so that it will measure four inches on a side when cold. The four-by-four, still glowing, is reduced to a two-by-two and cut into 30-foot lengths for convenient handling and just the right size for working into rod.

In the rod and wire mill, the two-by-twos are heated to a uniform 2,000° in a continuous furnace. The billets enter the first of seven stands in the roughing mill, creeping at a foot a second, and come out of the last stand in the form of diamond-shaped steel rod, roughly 9/16 inch on a side, speeding about 20 miles per hour. Again, flattened ends are cropped off, and the rod goes through 10 stands of the finishing mill, roaring out at a 50-mile-an-hour clip, still white hot. Now and then a rod becomes a "cobble"—it misses its roll and runs wild. Usually, however, the rod coils up smoothly into 400-pound "bundles."

Rod bundles are next dipped in hot sulphuric acid to remove scale, then rinsed in water, silica-soda solution, and lime. Then they are baked for 20 minutes to harden the lime coating.

After cooling, inspection, and labeling on a continuous hook conveyer, the bundles of rod are packed off to the cleaning house.

Cleaning is an important step. After the hot-drawing into rod, the steel is worked cold. Surface impurities and scale, being far harder than steel, won't draw into wire and play hob with the accurate tungsten-carbide dies. So the bundles are pickled in hot dilute sulphuric acid, then rinsed, limed, and baked.

Modern high-speed wire-drawing machines are capable of turning out 20 tons of wire per shift. In three drafts, 10-gauge rod can be reduced to five-gauge wire, with a consequent increase in length. The collecting reel generally takes up finished wire at about 20 m.p.h.

Now a shiny, smooth wire, the steel is finally ready to be made into nails. The process is deafening and nerve-shattering, because nail-making is largely a matter of the terrific impact of steel against steel. In the nail mill, automatic machines turn out large sizes, such as 12-inch dock spikes, at the rate of 90 per minute; half-inch, 20-gauge nails emerge at 600 per minute.

The wire is not fed into the nail machine continuously but in a series of jerks, ramming just enough wire into the gripper dies to make one nail. At the start of the cycle, enough wire projects beyond the grippers to form the head when a cam-driven hammer rises up and slams forward to upset it. By changing the hammer and the gripper dies, which act as the anvil, any type of head can be put on a nail: flat, oval, round, countersunk, corrugated, numbered, or bossed.

After the head has been formed, the gripper dies spring apart, the hammer cocks again, the headed wire moves forward and two cutters bite off the finished nail with

After removal from the oven the coils are greyish white. The lime coat forms a foundation for lubrication needed while rod is converted into wire by cold-drawing through dies.

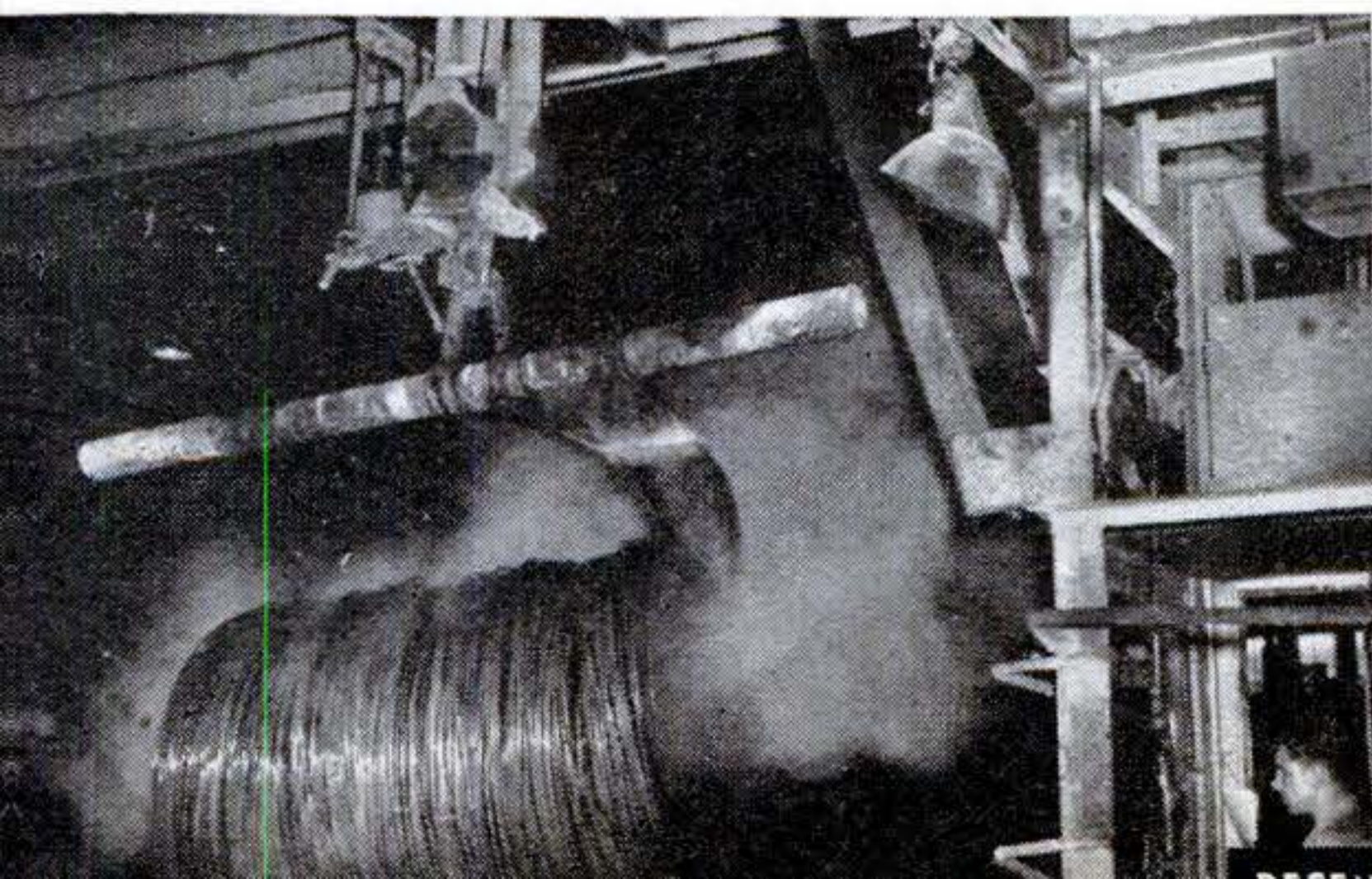

DRAWING WIRE

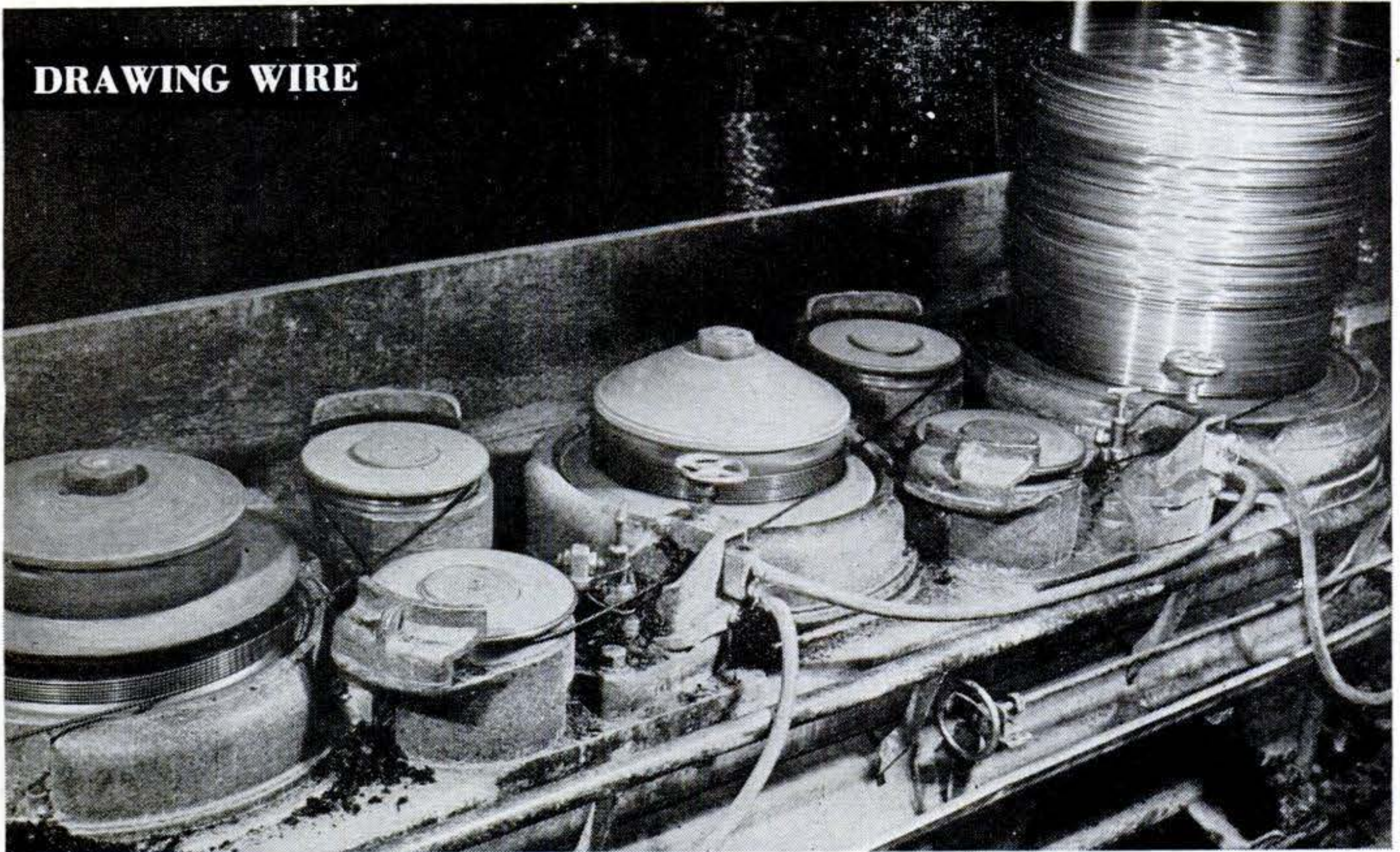

Here a 10-gauge wire is being drawn into 5-gauge. Three reels at left hold wire after it has passed through first draw. Second draw, in center, makes wire pass through opening smaller

than its own diameter, so that it is stretched and made smaller. Three reels at right then take it up again and pass it to third draw, at far right, which brings it down to final size.

the proper point: diamond, needle, duck-bill, chisel, or flat. The marks on the nail below the head are made by the grippers. Steelmakers use various marks to brand their nails, and police cases have been

solved by this method of identification.

As they stream out of the machines, nails are rough, whiskered, and burred, so they are tumbled in rotating drums. The nails, churned against the drum walls and each

MAKING NAILS

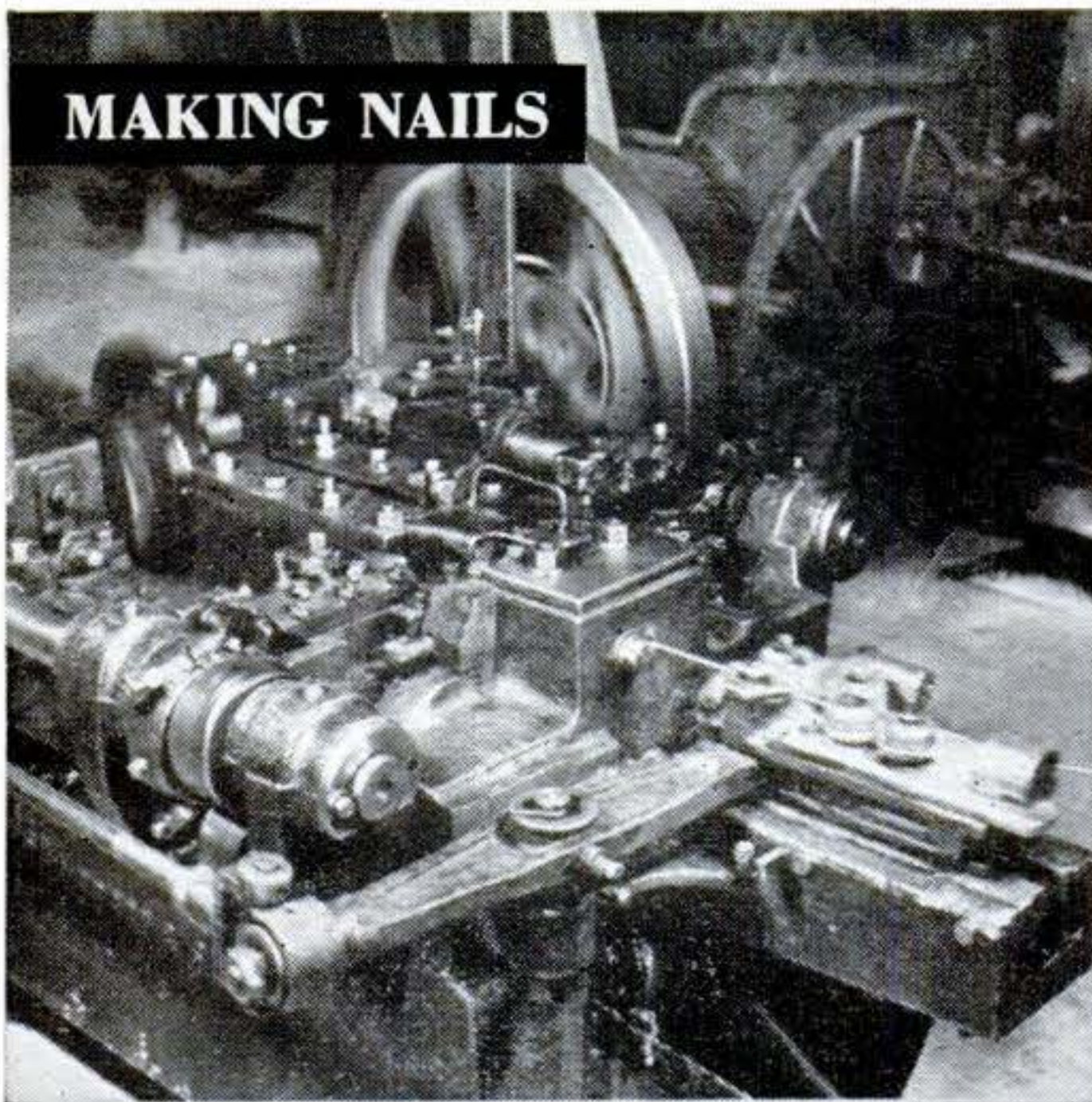

The nail machine now goes into action. Here it is cutting 5-gauge wire into 8-penny nails. The nails are popping out of the machine at the rate of 325 a minute. Twelve-inch dock spikes can be turned out 90 a minute; half-inch, 20-gauge nails, 600 a minute.

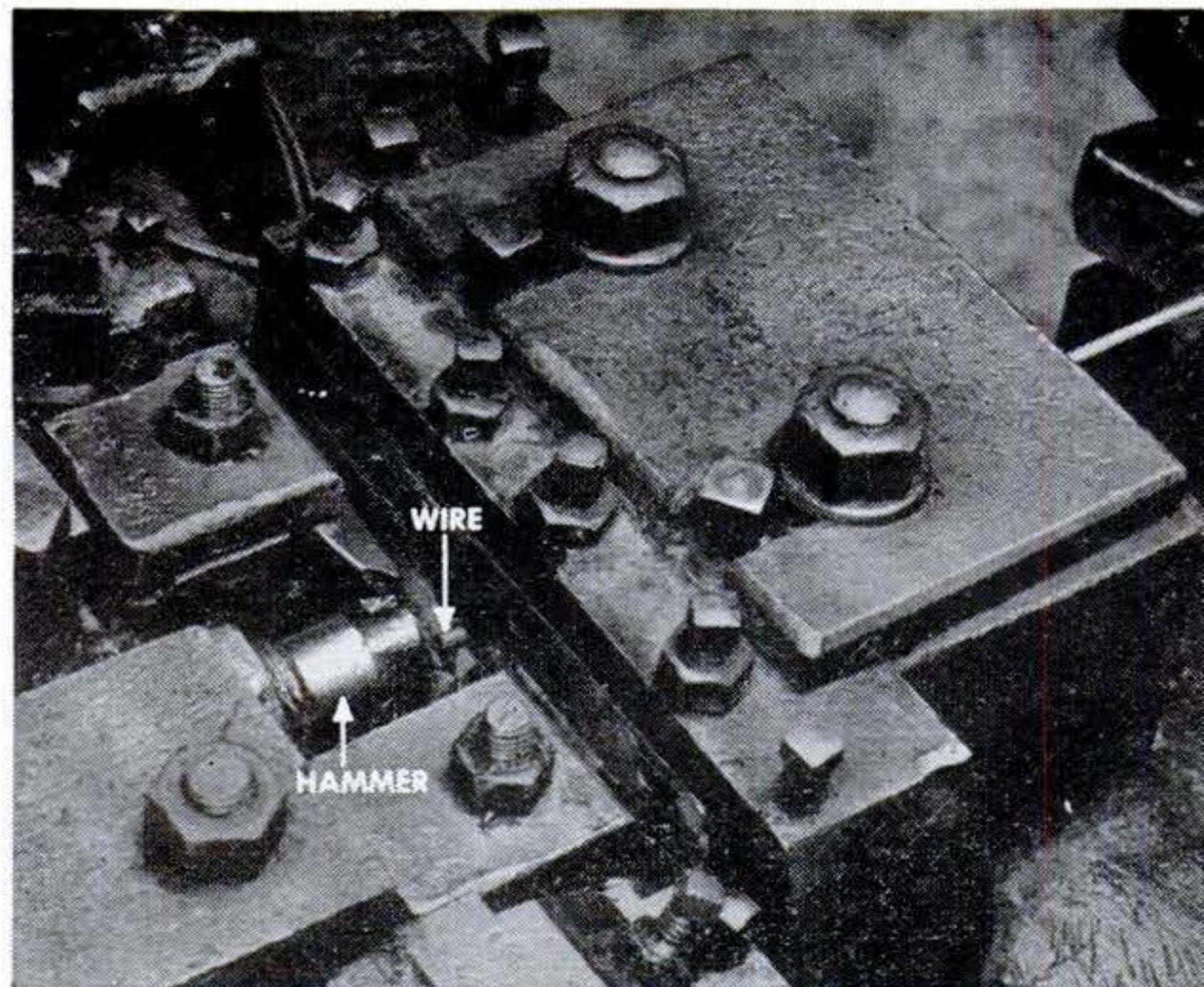

Close-up of automatic nail machine shows the wire entering at right. At left center, just enough wire is sticking out of the gripper dies to form the head when struck by the hammer, at left. The cutter bars that make the nail point are now retracted.

other, are polished; sawdust picks up the oil, grease, and little slivers of waste steel. Poured out of the drum, the nails are shaken into the standard 100-lb. kegs you see in the hardware stores.

For many nails, however, tumbling is by no means the final operation. Cold-working makes the nail brittle; where a softer product is needed, as in clinching hinge nails, they are annealed in a furnace. Galvanized nails for outdoor work and roofing are tumbled in a bottom-heated drum containing flake zinc and a sal-ammoniac flux. When the zinc melts it flows evenly over the nails, coating them protectively, while the tumbling keeps the nails from sticking together. Cement-coated nails (which are *not* really cement-coated) are made by tumbling nails in a mixture of pitch and resins in solution. When the solvent evaporates, the coating becomes hard and smooth. The heat caused by driving a coated nail melts the mixture enough to "glue" the nail to the wood. Plated nails get that way in an electroplating bath, and painted nails are tumbled in a thin paint solution. Needle-pointed nails can never be tumbled; they have to be kept free from grease during manufacture and made so carefully that they have no whiskers when they emerge from the machines.

Short nails can be barbed with deep notches by special gripper dies; longer ones call for barbing rolls on the nail machine.

Besides cement-coating, nails can be acid-etched or equipped with "fetter rings"—small circlets formed by gripper dies below the head.

The best nail for the job is the type with the greatest holding power that causes the least distortion of the wood fibers. One of the reasons for the seemingly fantastic variety of nails is this necessity for maximum holding power in even more varied uses and materials. Where there's a will to join wood, leather, rubber, metal, or many other materials, there's usually a nail. **END**

Fiber Scales May Shrink Wool

WHY does wool shrink? One theory is that once the fibers draw together, as they do when wet, the scales on the fibers prevent their being pulled apart again.

X-Rays Developed Automatically

DOCTORS now can read X-rays an hour after they are taken. A completely automatic machine, developed during the war for processing industrial X-ray film, is being installed in hospitals that handle large quantities of X-ray work. Films ride a conveyor through developer, hypos, fix, wash and dryer at the rate of one per minute. In an emergency film can be read while still wet, after only nine minutes of processing.

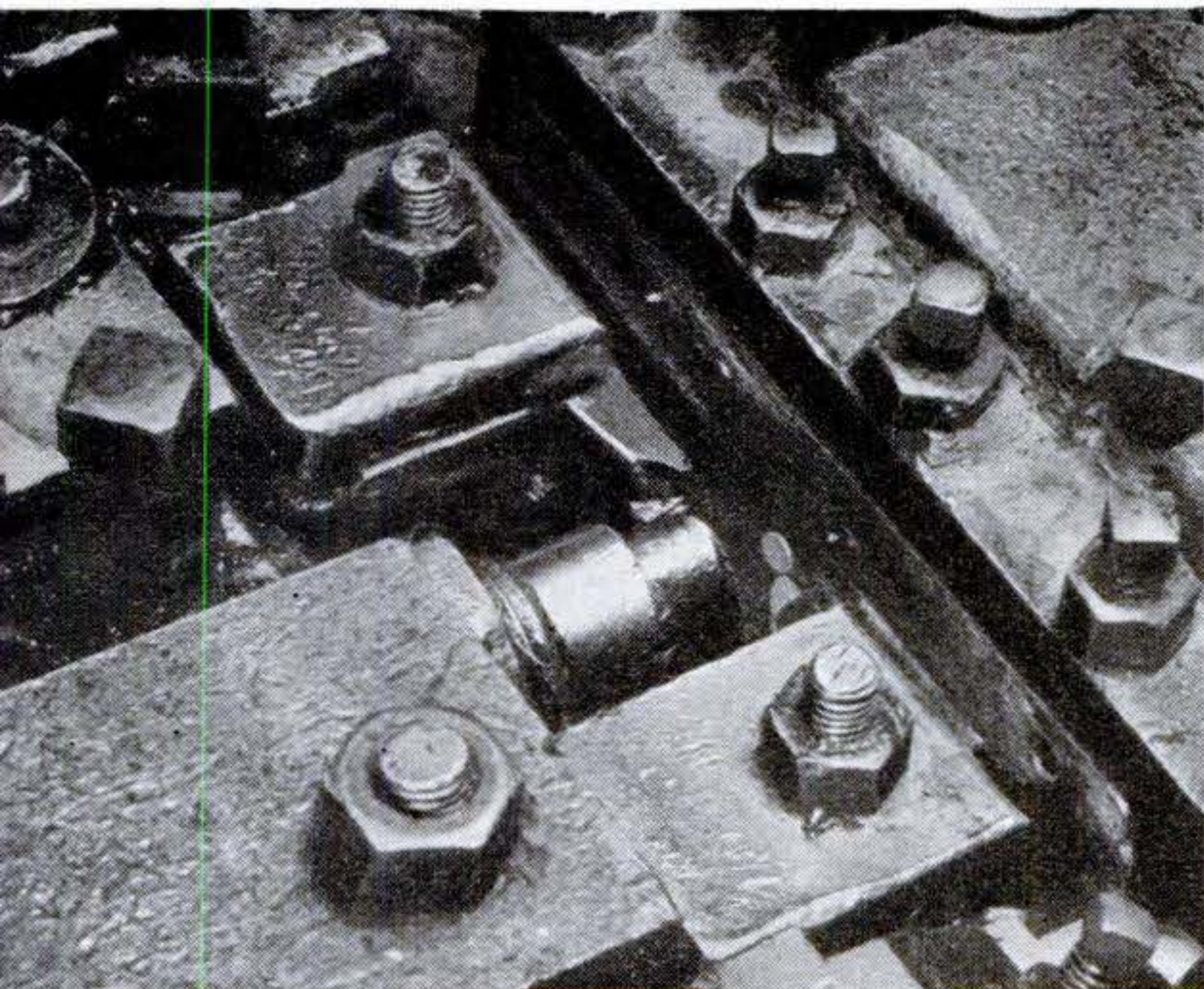

Now the hammer has struck, flattening the projecting wire to form the nail head. In a moment, the wire will move to the left, ready to be cut off as a nail. The 8-penny nail, whose manufacture is shown here, is the most popular size of the most useful nail in the world.

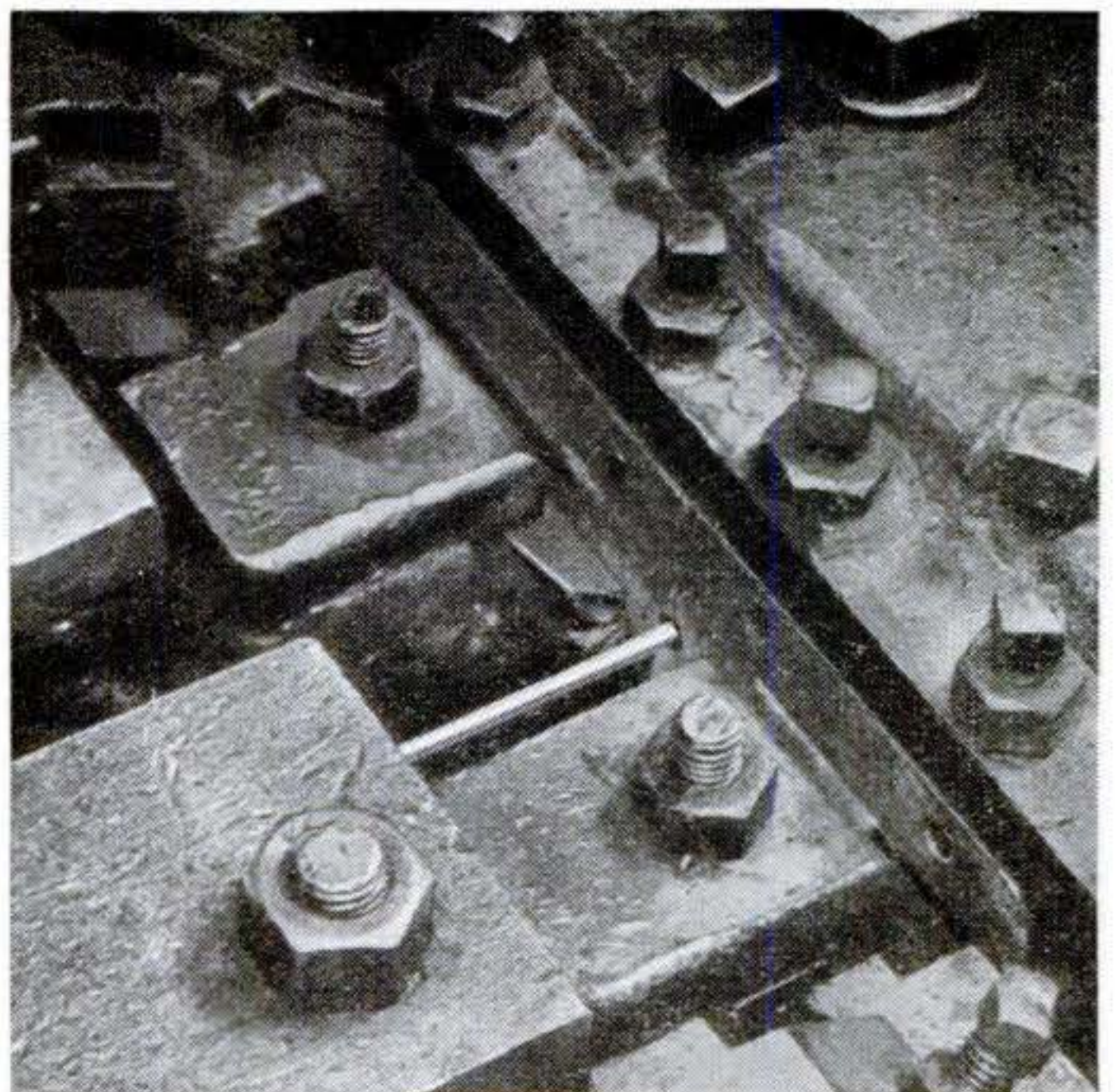

The wire has now moved to the left, pushing the head out of sight, but revealing the gripper marks just below it. The cutter bars are about to come in and make a diamond point as they cut the nail off the wire. Next the nail will be tumbled to remove roughness and grease.

They Still Cut Ice the Old Way

HARVEST time is approaching on the Black River at Carthage, N. Y., where the New York Central Railroad still cuts an annual crop of natural ice. It will cool next summer's milk cars, passengers' drinking water, and be used in cabooses for the convenience of freight-train crews.

When the railroad started cutting ice on the river in 1901, it was a big operation. A

decade ago 35,000 tons were cut every winter. But modern refrigeration methods, especially milk tank cars that work on the principle of a Thermos bottle, have cut into the operation. When one of two storage houses burned down, it wasn't rebuilt.

Even so, the New York Central is probably the biggest harvester of natural ice in the country nowadays. This winter the railroad expects to cut an estimated 12,000 tons of ice at Carthage and other cutting areas.

During severe winters, with three and four feet of snow on the ground and the temperature down to 20° below, 100 men and at least two teams of horses are needed to keep the work moving. Old-timers recall a record freeze when the ice was cut 32 inches thick, making individual cakes that weighed 736 pounds, or almost two-fifths of a ton for each chunk.



1. Icehouse has capacity of 7,000 tons. At far left is inclined conveyer that lifts the cakes to moving gallery. This runs outside the

length of the building, carries the blocks to doors of storage rooms. Crew in foreground is splitting large floats into single cakes.



2. Horse-drawn scrapers are first on the job, cleaning snow off the ice. The sheet must be frozen to a thickness of at least 12 inches before the harvesting operation can begin.



3. To provide room to work, first cakes are sawed by hand. End of the field is located upstream from storage house so that river current can help move ice down to conveyers.



4. **Gasoline-powered saws** take over. Working in teams of two, one laterally and the other longitudinally, they cut cakes measuring 32 by 22 inches. Blades bite 10 inches into the ice.



5. **Floats of five cakes** ride the channel. As these approach the conveyer, barring forks are used to split them through below the point reached by the saw, producing single cakes.



6. **Man with pike** urges the single cakes onto a conveyer that carries them up to a moving gallery that is adjusted upward as the ice storage house is filled higher and higher.

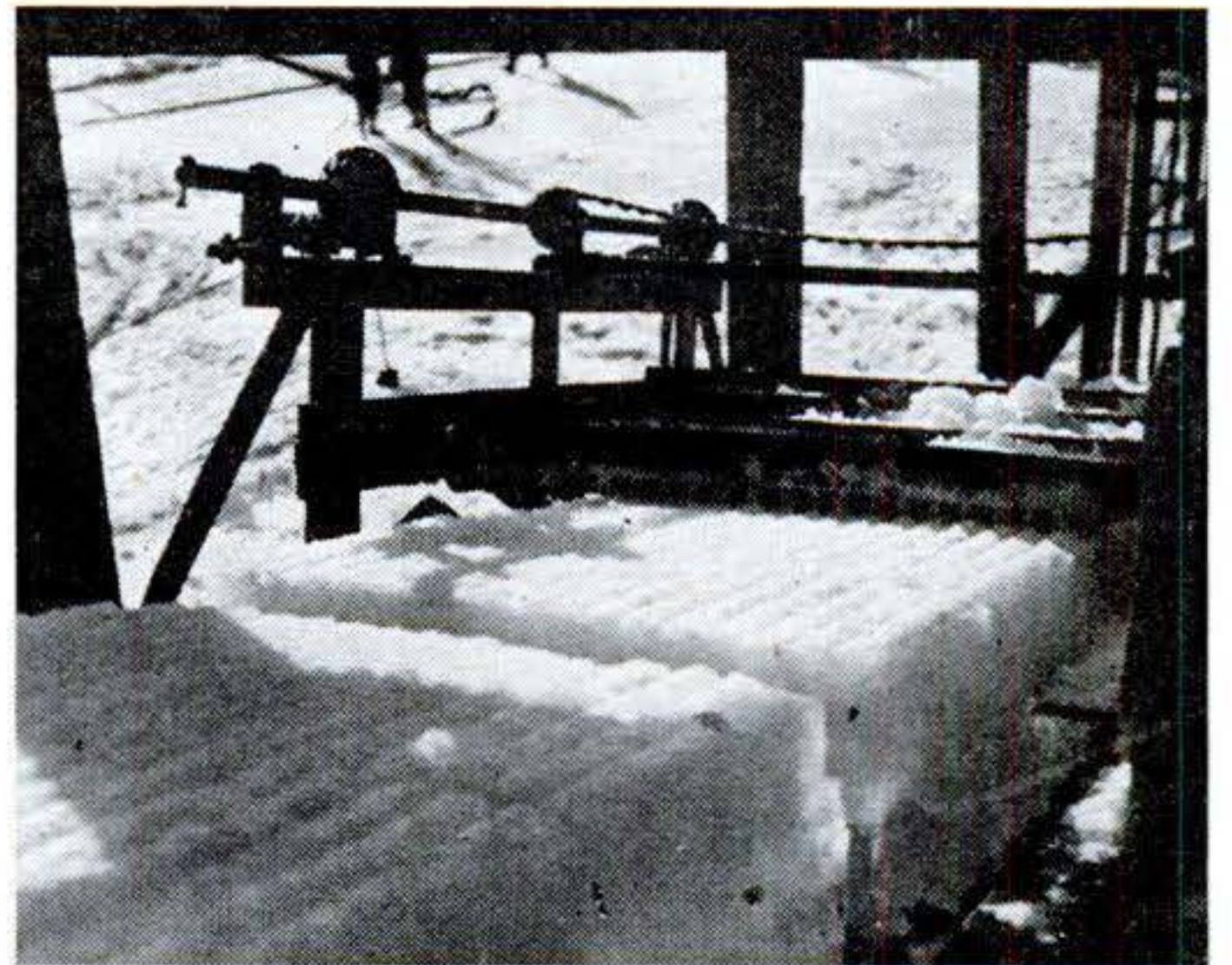

7. **As the individual cakes** move up, a planer shaves off slush and gives a rough surface to the ice for easier handling. Fourteen-inches of ice produce cakes weighing 322 pounds.

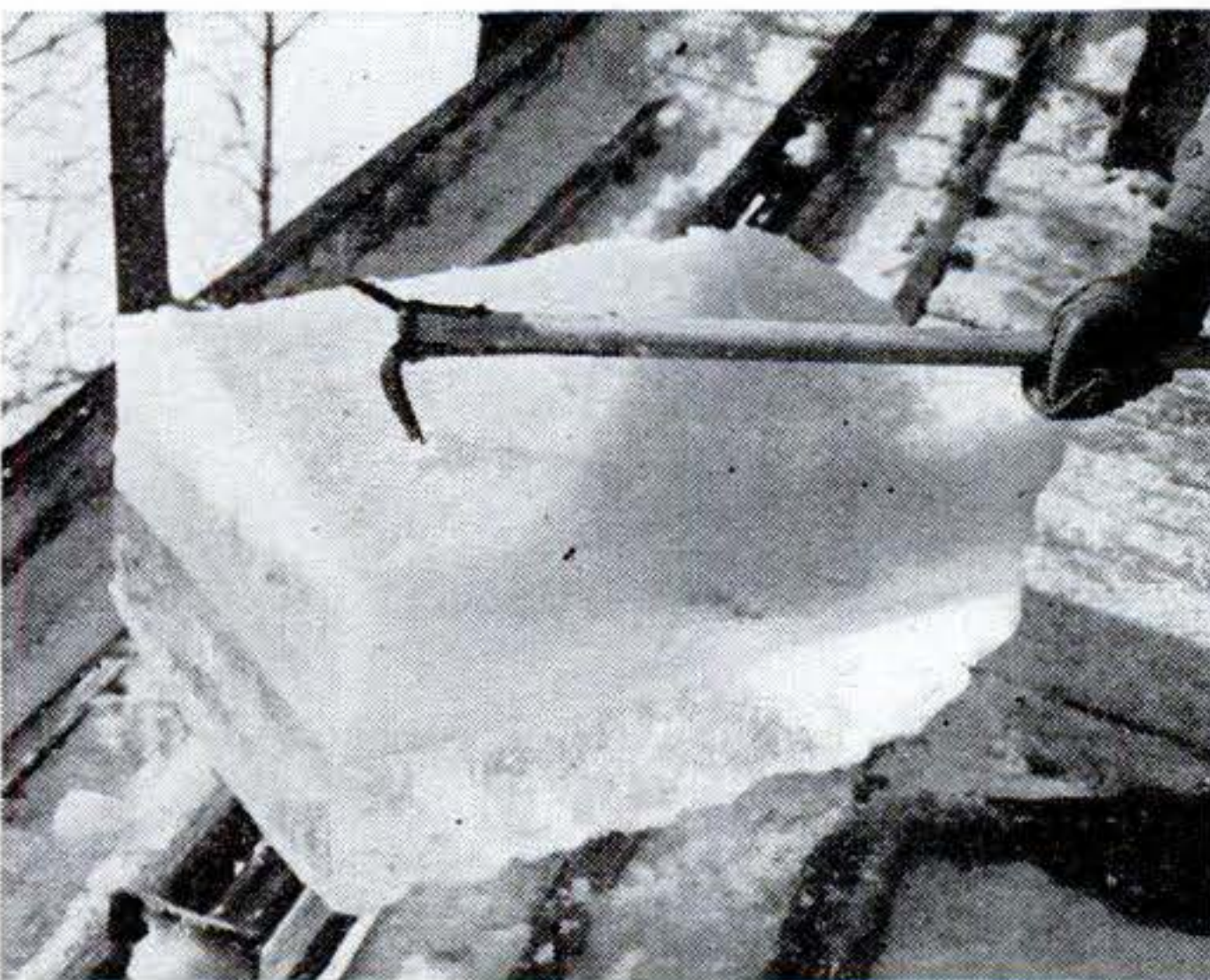

8. **As the cakes** move along the length of the icehouse, men with hooks stand at each of the eight entrances to the storage rooms and pull the cakes inward at the rate of one a minute.



9. **At 10 miles an hour**, the cakes slither down a chute to the packing crews. Keyman is the switcher, who must catch the quarter-ton blocks and guide them to where packers are working.

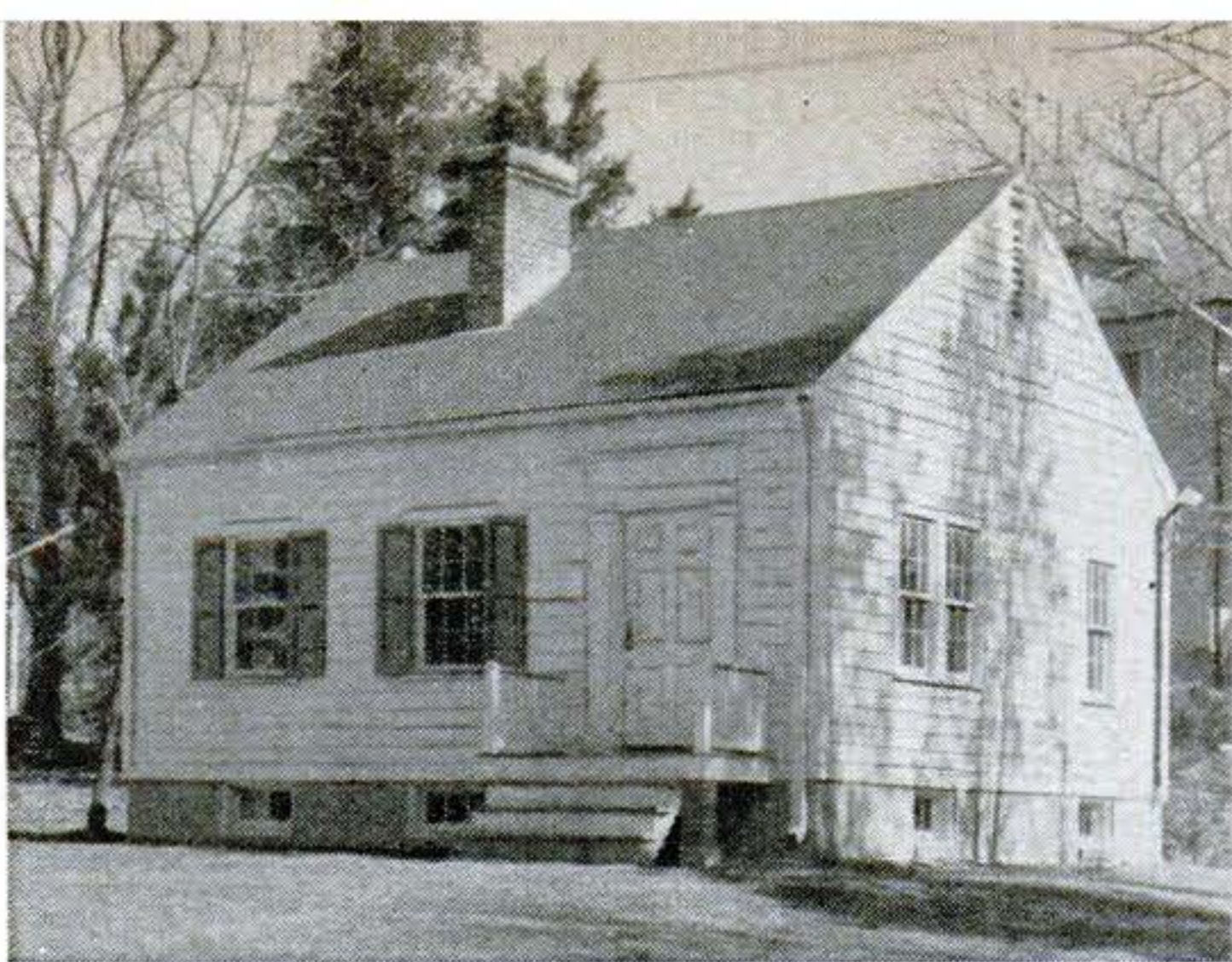

House Tests Heat Flow

IF ANYONE is cold in this house, it won't be for lack of heat—the house has nine complete heating systems, while scores of special heat-measuring gadgets take its temperature by the square foot.

Built by the National Bureau of Standards to test heat distribution and equipment, the bungalow was equipped with gas, oil, and electric heaters of various types, with meters to determine heat loss through walls, floors, and ceilings; thermocouples for temperature variations; and recording thermometers. The house itself, since enclosed in an insulated shell, follows plans widely used for low-cost homes, with the exception of wall insulation and weatherstripping.

Chief discovery was that many heating systems produce wide temperature varia-

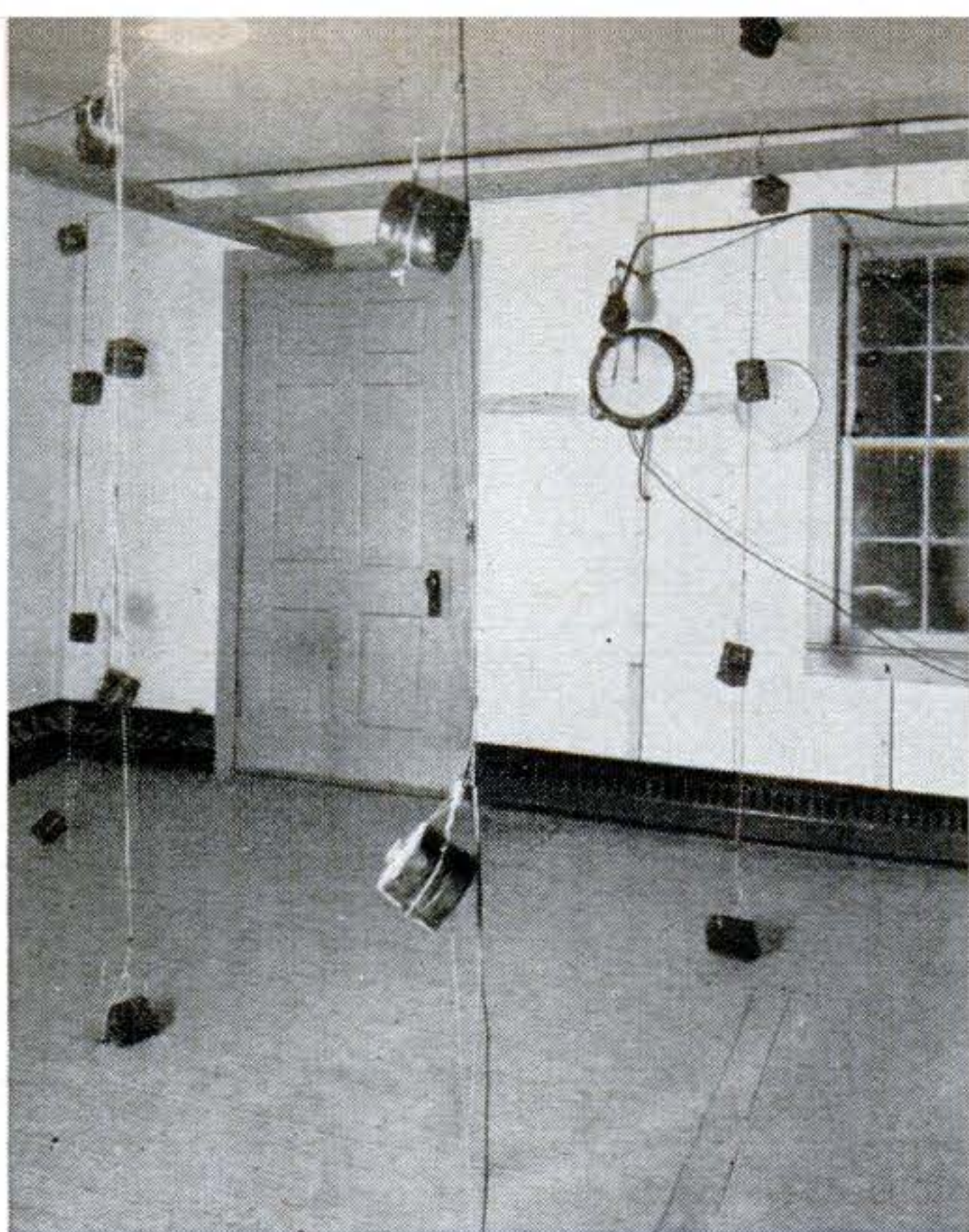

Closely spaced thermocouples, suspended from the ceiling throughout the house, register minute temperature variations at different levels.

tions between foot and head levels, which, for health and comfort, should not exceed 15° , say engineers. So far, top honors have gone to a hot-water furnace, which squeezed the difference down to a mere 5° , and an electric heater and a gas heater, both equipped with blowers, which held the difference to 10° .



Sphere Maps End Errors

THE problem of navigating a round world with a flat map may be solved by the use of curved maps that eliminate the distortions of flat projections—distortions that complicate long-range, high-speed flight planning.

Devised by Col. Carl J. Crane, U. S. Air

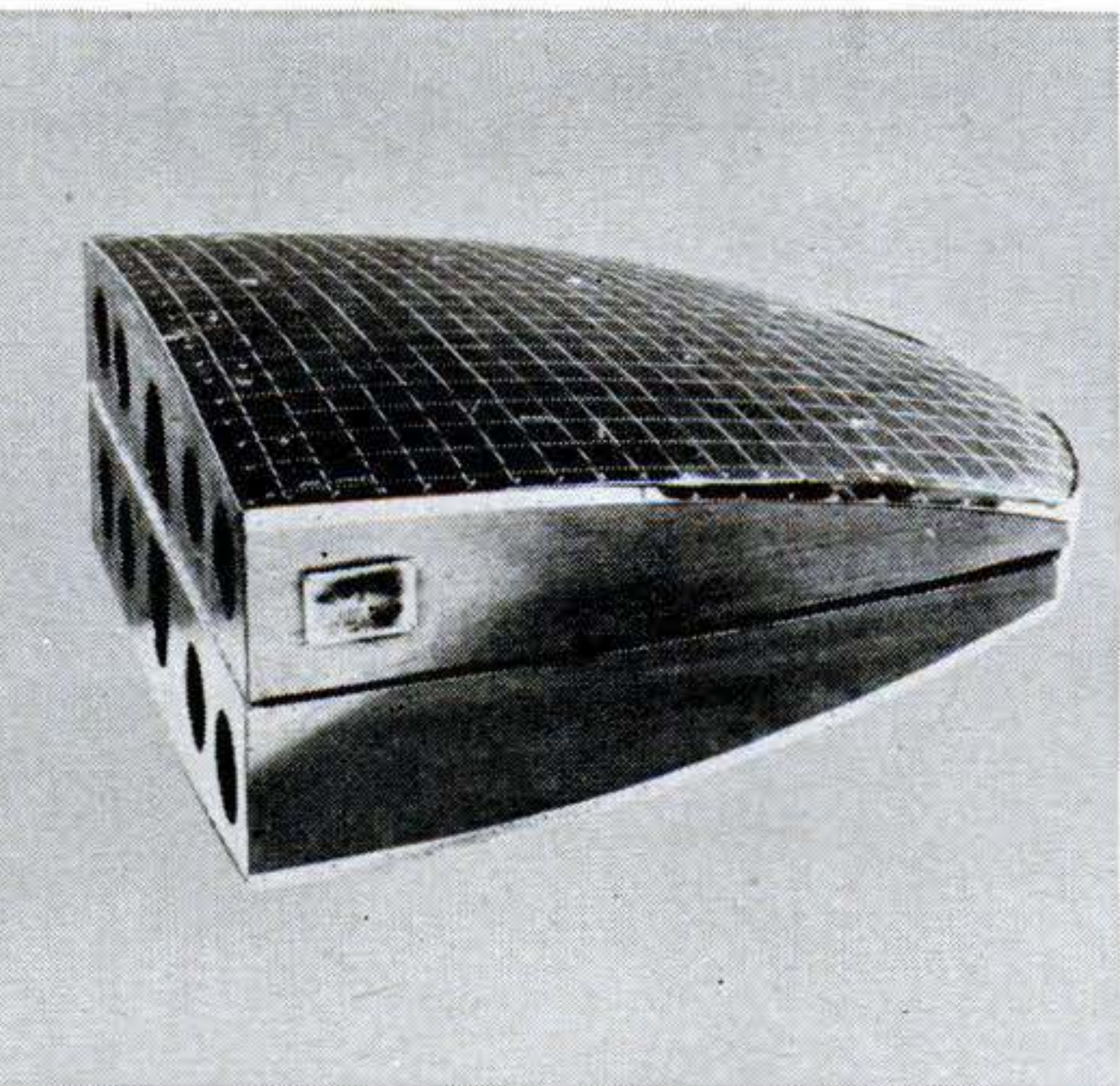

Force, the slightly curved maps are actually sections of what, if assembled, would be a giant, 17-foot globe. Formed of translucent plastic, they can be fitted into the plotting table, at left above, and sections necessary for a particular flight can be carried in a plane. A special version of the air map is shown folded on the right.

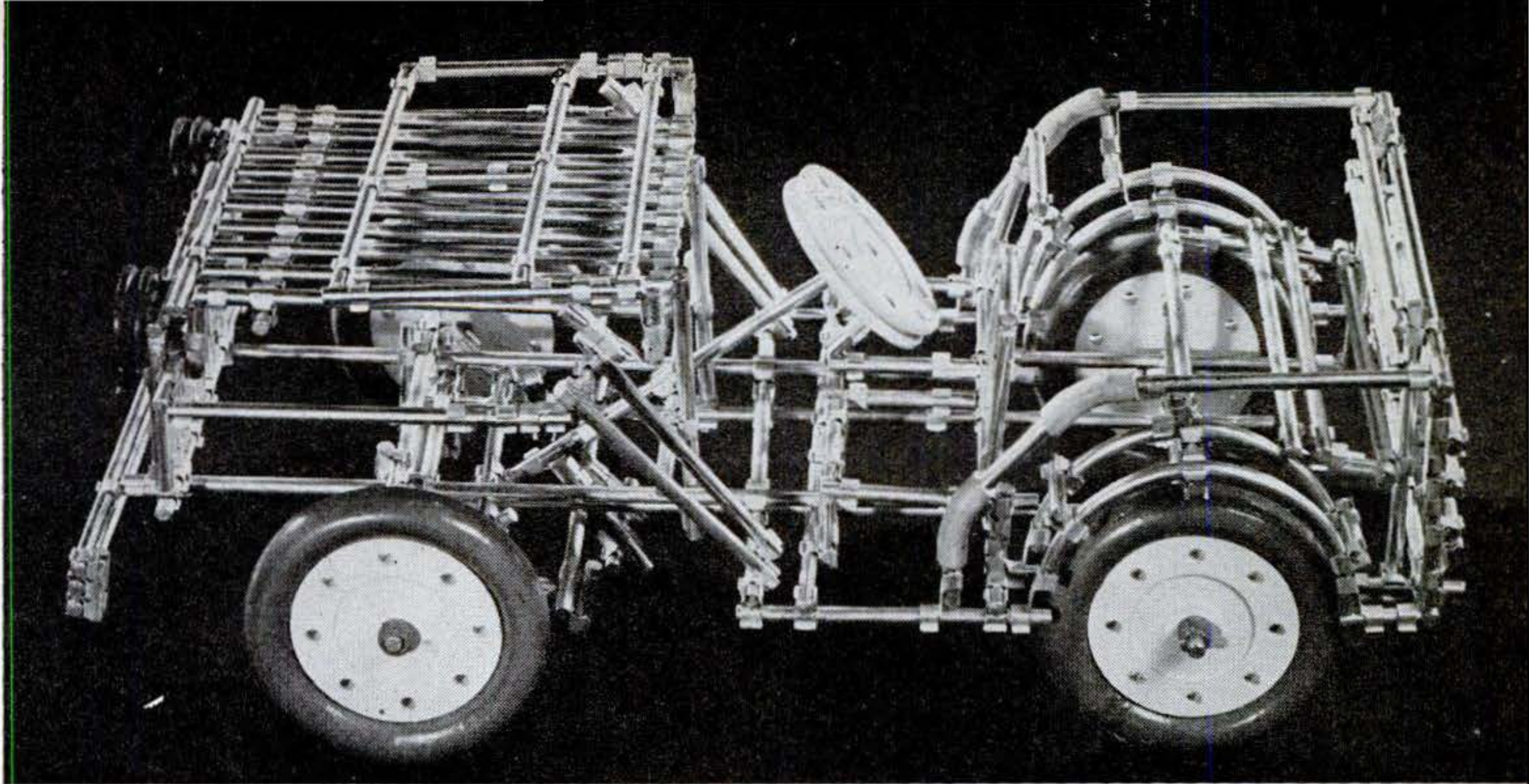

This toy jeep may look complicated, but new construction set's clips make it easy to build.

Clipping a Toy Together

TAKE some straight and curved rods, snap them together with steel clips, add a few wooden wheels, and you have built the toy jeep shown above.

Secret of the new construction set, made by the Clip-Craft Corp., of New York City, is in the specially tempered steel clips that hold the aluminum parts tightly in place. Their edges are rounded and turned outward, so that a slight finger-tip pressure is all that is needed to insert the rods and arcs; dismantling is just as easy. The snap-action clips take the place of screws, nuts, and bolts, and make tools of any kind unnecessary for building even the most complicated structures.

Flat sheets of aluminum are furnished for covering surfaces of the models and for fashioning fins for planes. The wooden wheels can be used for gears and pulleys.

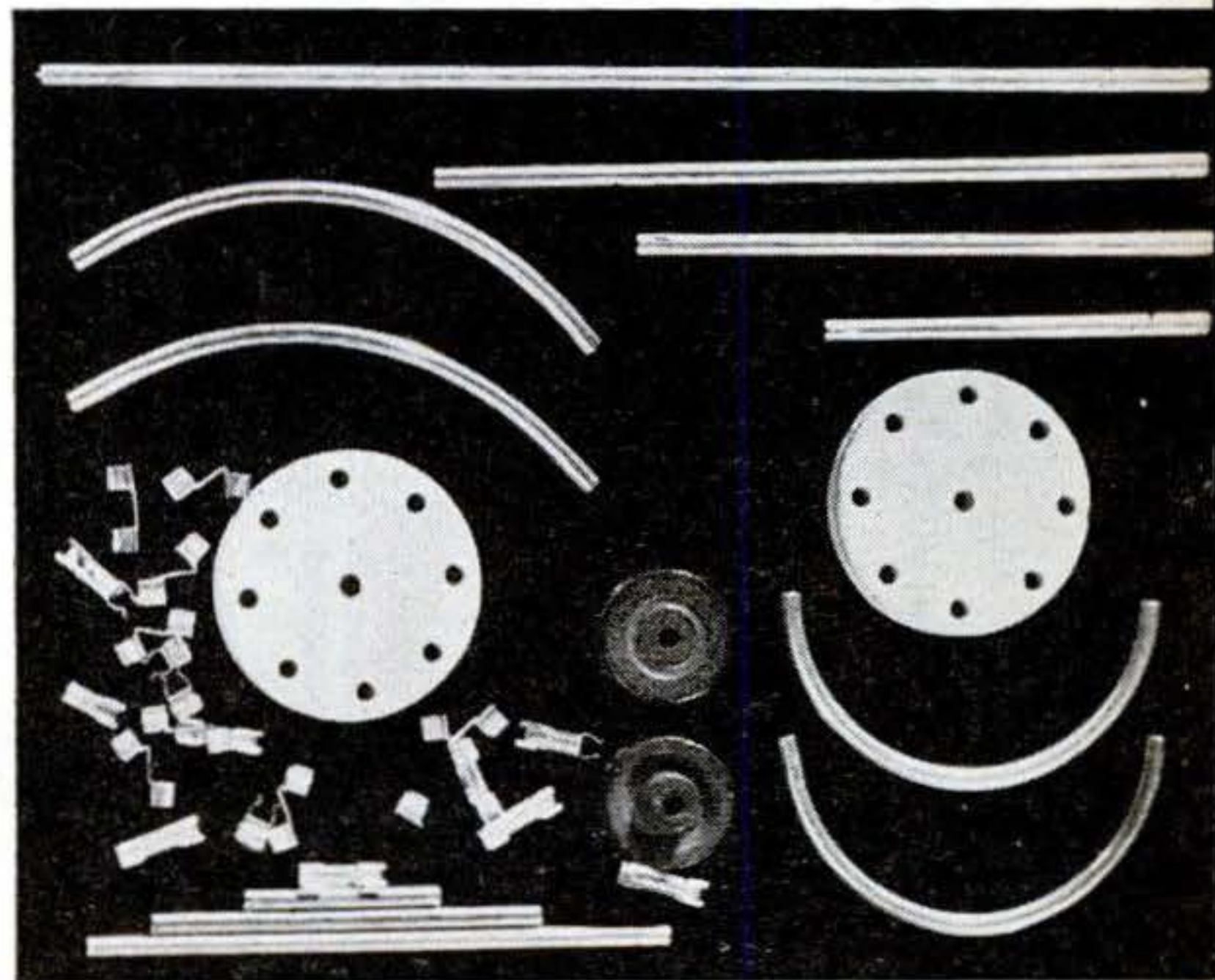

Using only these basic parts, hundreds of different toys can be clipped together. Arcs can be used to form complete circles.

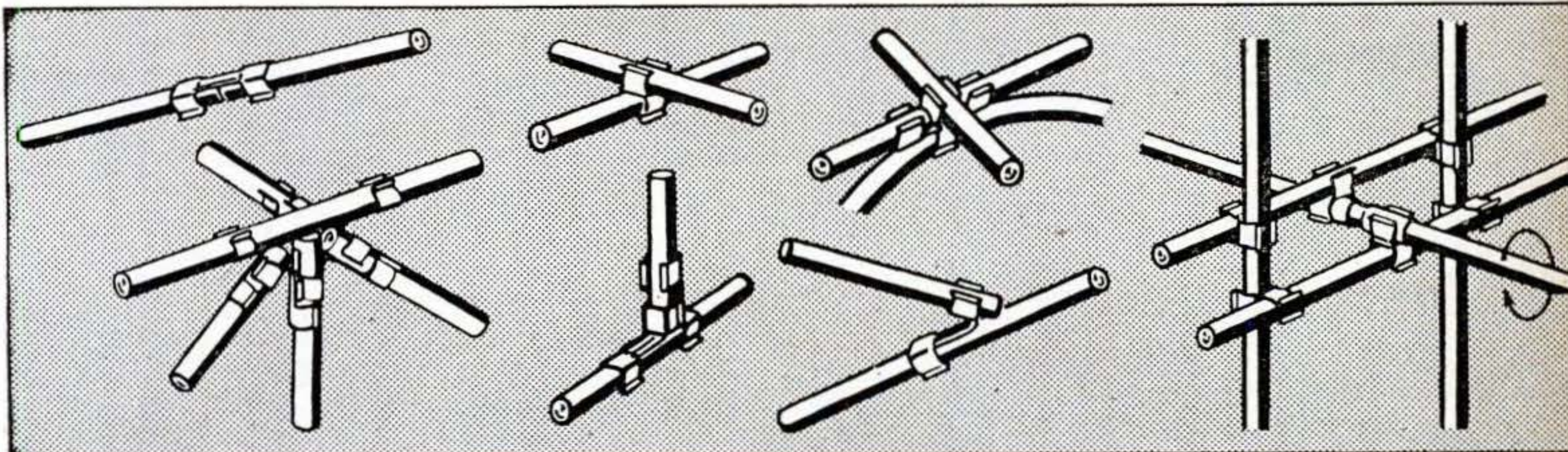

These are a few of the joints that can be formed by combinations of the rods, arcs, and clips.

A bearing added to a joint makes it a support for rotating or sliding shafts.



New 6,000-horsepower engine in foreground heads line-up of Diesels outside the new shops.

Shop in Desert Keeps Diesel Giants Rolling

BARSTOW, Calif., the gateway to Death Valley and once a desert junction for overland wagon trains, will soon be the center for servicing the Santa Fe Railway's fleet of huge passenger and freight Diesel-electric locomotives.

Although some of the overhauling and servicing shown on these pages is now done at other points, most of it will be transferred to Barstow as soon as new facilities are completed. Already the desert service center handles over half of the more than 700,000 Diesel horsepower the Santa Fe road has in operation.

Overhauled Diesel engine is lowered into a unit of the locomotive. When new shops are in full operation, they will handle every kind of

work, stock 10,000 replacement items for all types of Diesels. At present 42 locomotives go through the desert center daily.

148 POPULAR SCIENCE

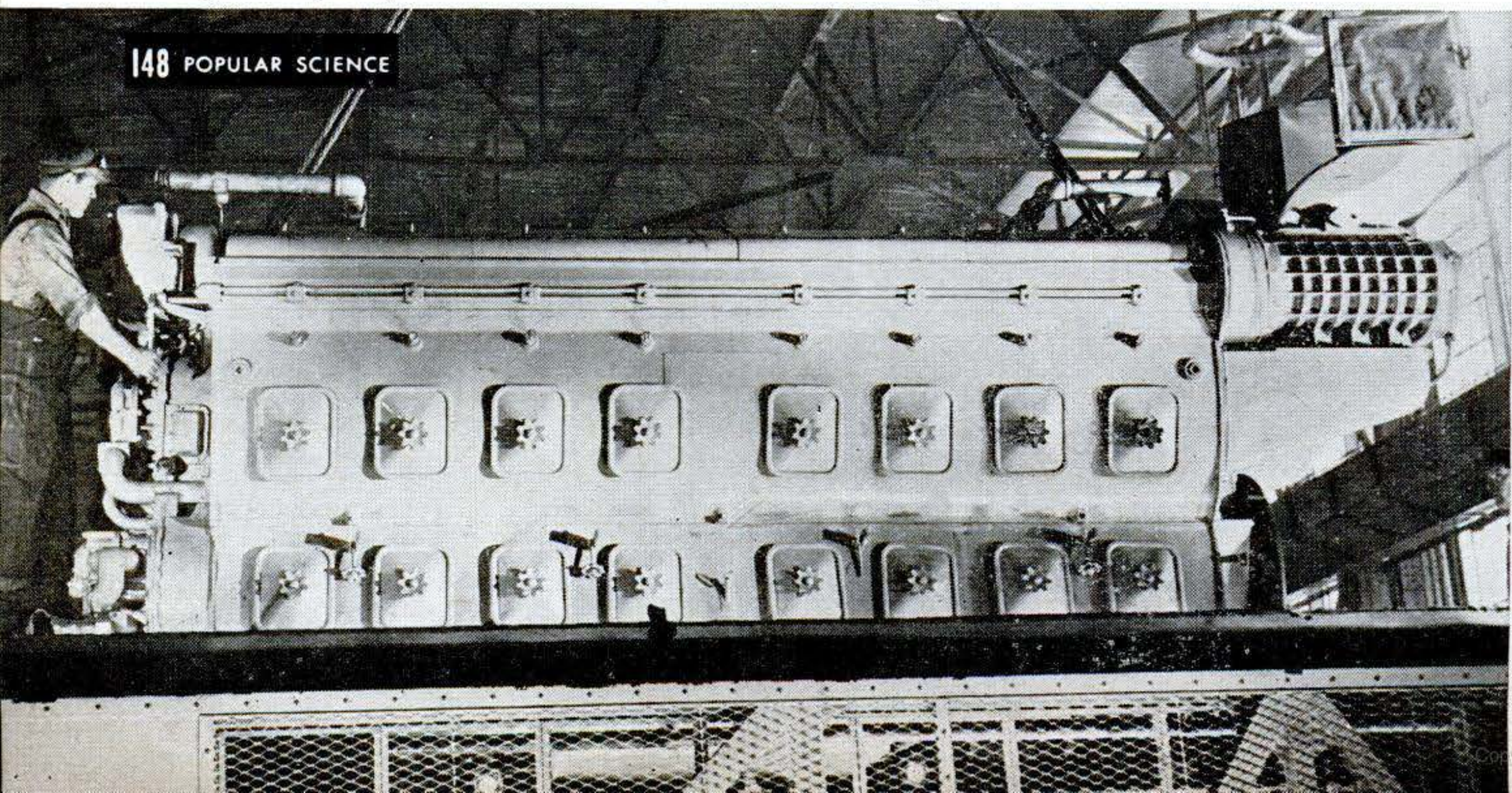



Major repair jobs on trucks and engines of the Diesel-electric units require the use of heavy-duty hoists and giant cranes. Here a 250-ton-

capacity crane lifts the body of a locomotive as workers wheel the trucks away so that new ones can be brought up and bolted into place.

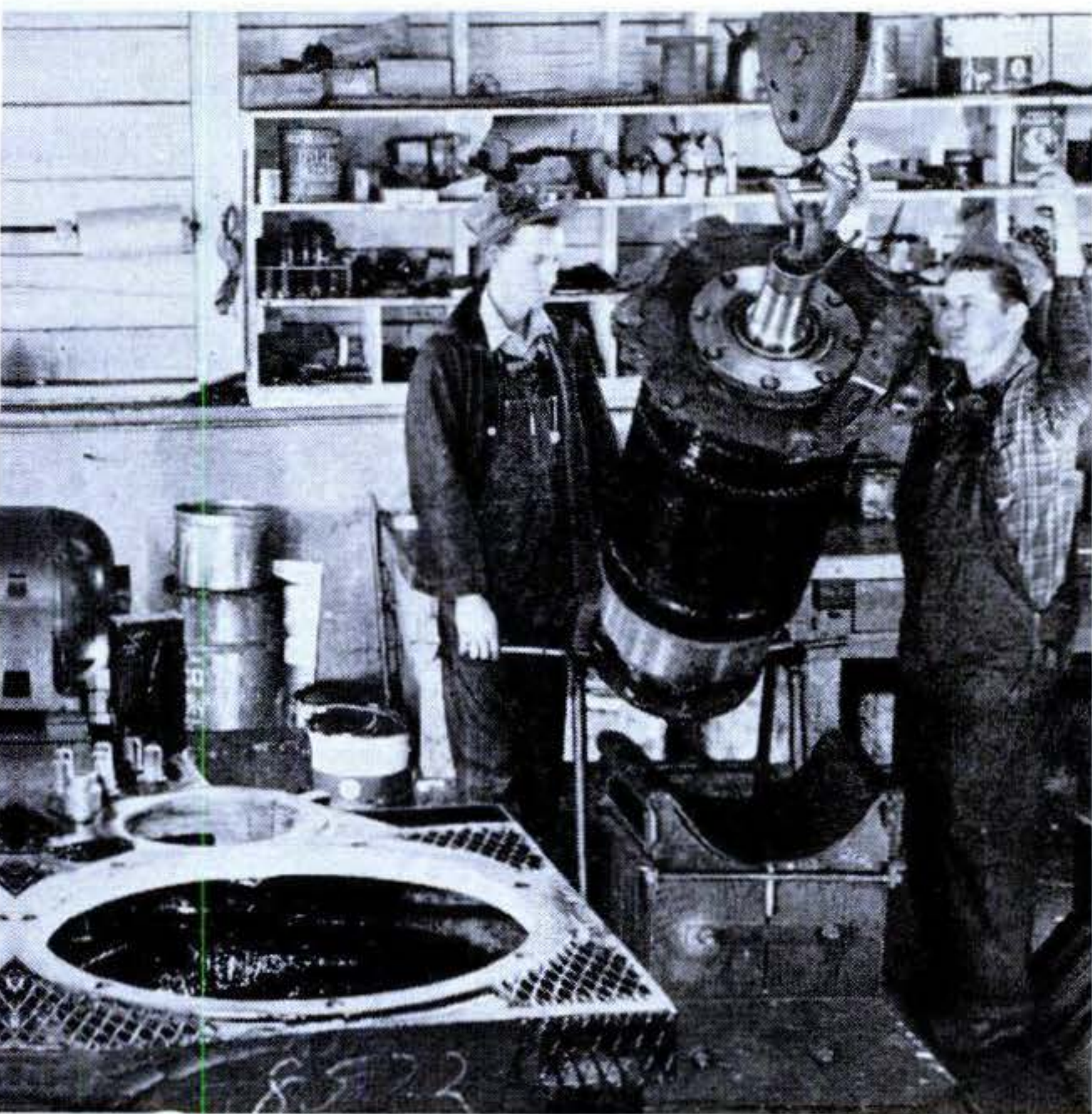

After overhaul in electrical shop, traction-motor armature is picked up by air hoist for return to frame in the foreground. Unless it balances within half an ounce, it is rejected.

Fuel injector, heart of the Diesel engine, is shop-tested by applying pressure to the spring plunger, creating pump action. This shows whether orifices are open for proper functioning.

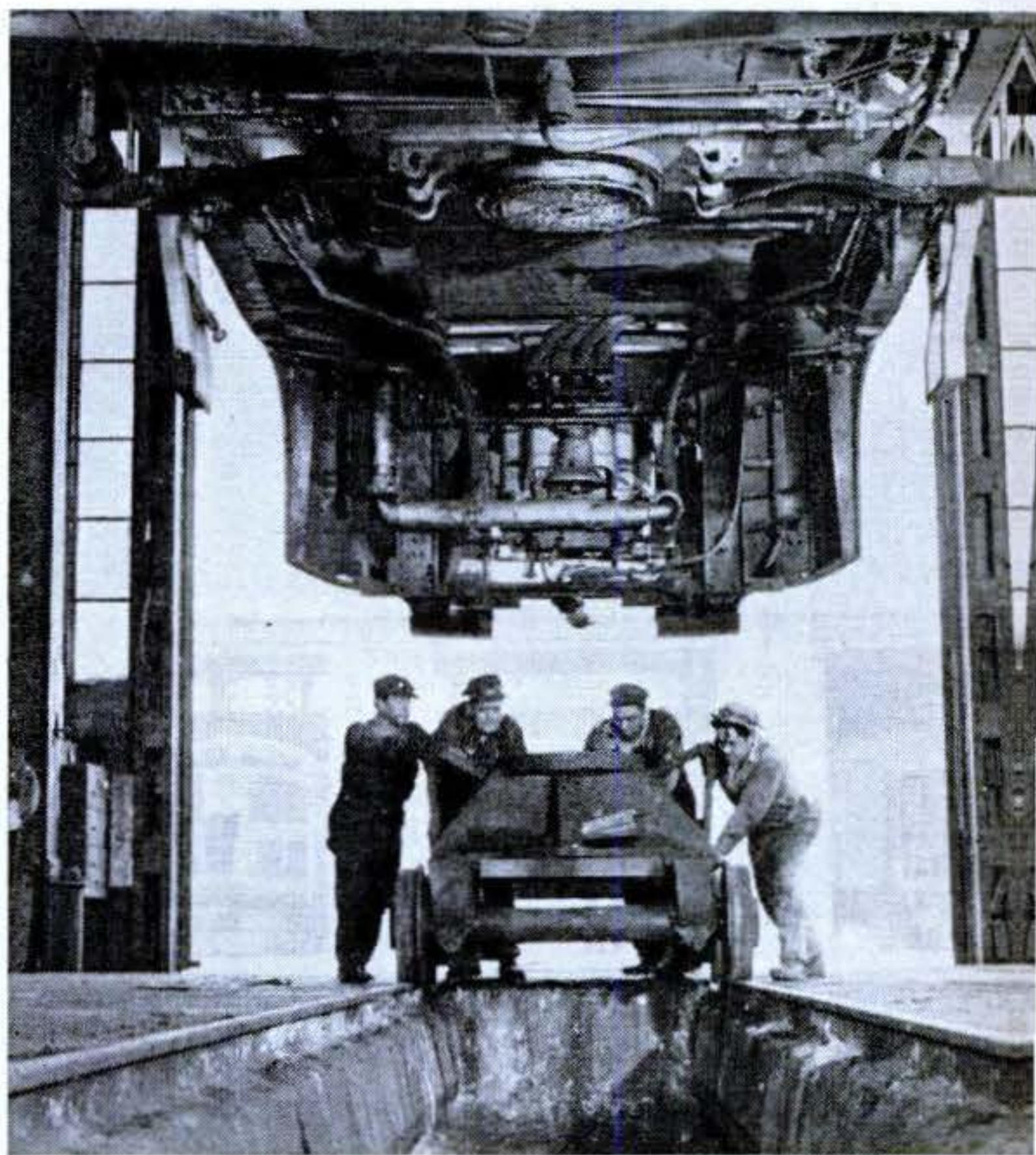
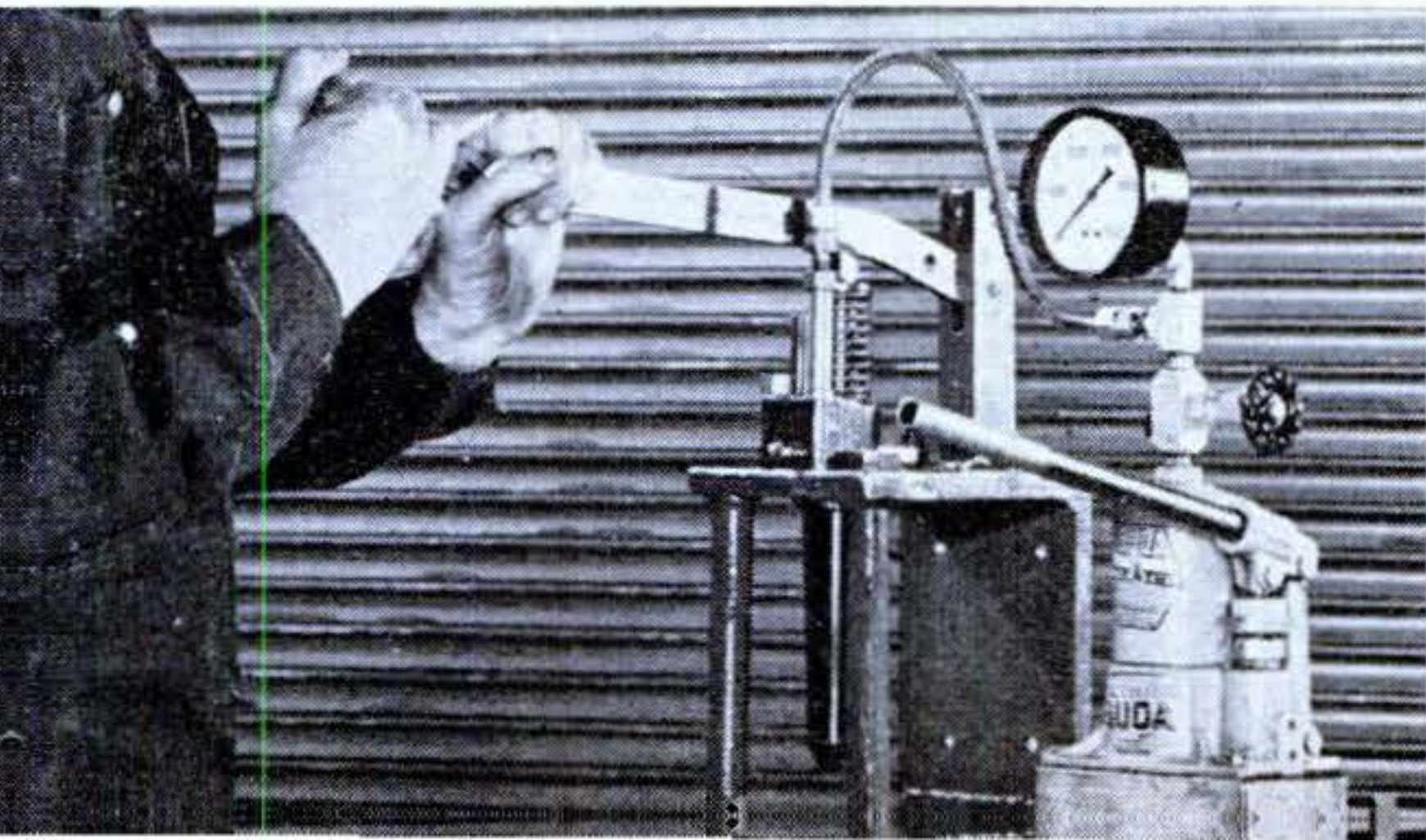

Only four men are required to handle dollies onto which locomotive is lowered after trucks have been removed. Locomotive is then wheeled away to make room for another unit.

Fuel, lubricating oil, and even the air in a Diesel locomotive must be filtered to eliminate grit and dust. This geyser of cleaning solution is spraying one of the many filter units.



Antenna Gives Plane Radios Global Range

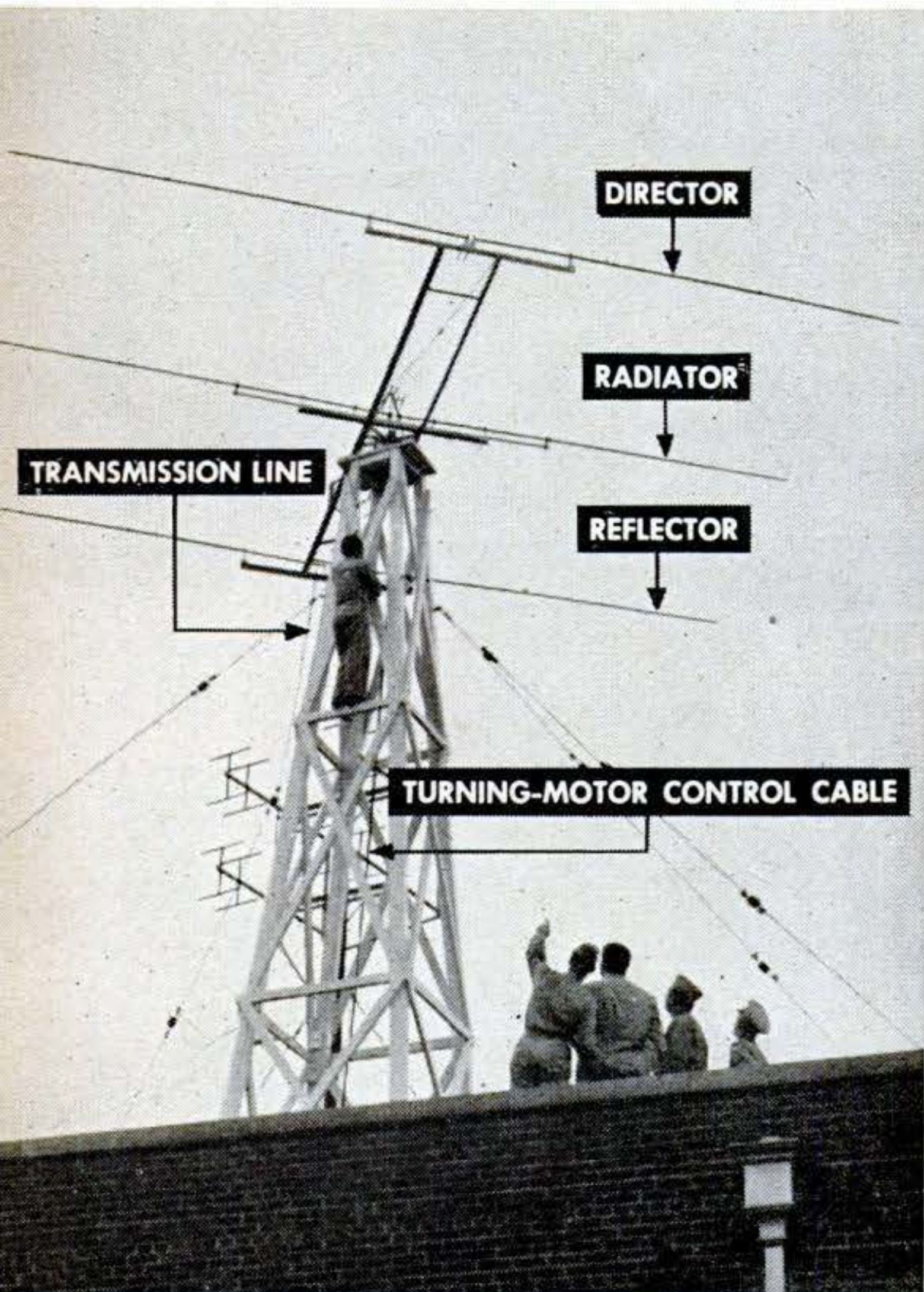

High-frequency rotating three-element array antenna, developed by the Air Force and Army Signal Corps, permits long-range communications between planes and command headquarters.



System requires no special equipment in plane. Using standard AN/ARC-8 liaison transmitter-receiver installed in all Air Force aircraft, operator has world-wide radio coverage.

GLOBAL air power needs global radio communication. The United States Air Force has both. Recently a flight of B-29 Superfortresses left Tokyo bound for Washington on a one-stop flight. Forty minutes out, they turned on their radios and a few twists of the dials brought them into direct contact with headquarters-on-the-Potomac, some 6,000 miles away.

The planes didn't have any special equipment, used their standard liaison radio sets. Something new had been added in Washington, however—a "rotary beam parasitic array antenna" that literally tracks a plane along every mile of its flight any place in the world.

Known to radio hams for years, but used heretofore only for point-to-point transmission and receiving (PSM, Aug. '47, p. 92), this was the first use of the system for long-range air-ground radio communications.

The first transmission from the planes in flight gave map co-ordinates of their position, their indicated airspeed, altitude, and course. The radio operators in Washington then calculated the approximate position of the planes at the next scheduled transmission. The rotating beam was swung to bear on the expected position, and when the planes began sending, the antenna was tuned until the strongest possible signal was received.

With emphasis on long range both in military and commercial planes, the advantage of instantaneous communication with a flight, no matter how distant, is obvious. Another advantage is the compactness of the new ground antenna unit, plus the push-button action that swings the tracking antenna completely around the compass in less than a minute.

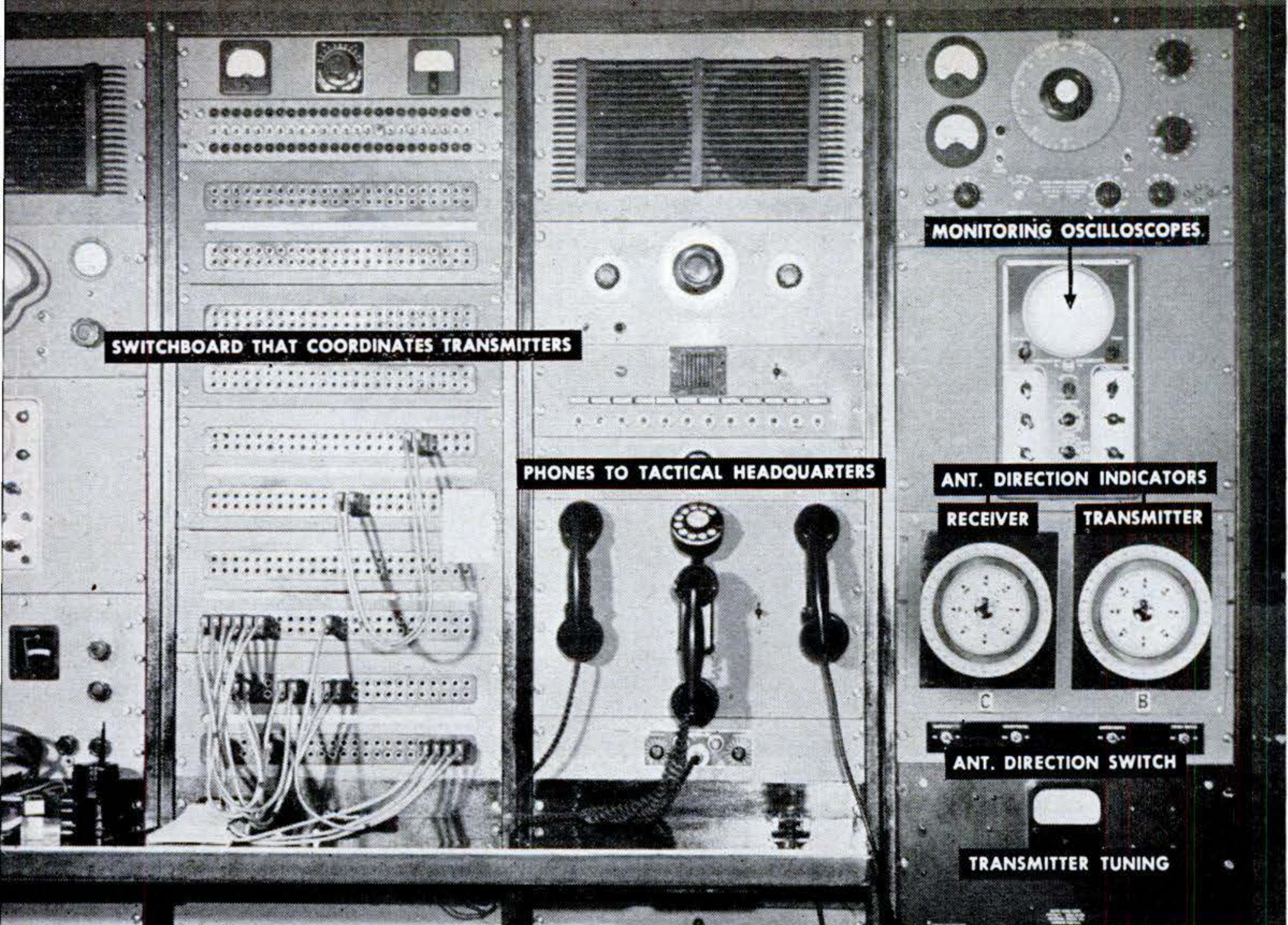

Brain center of the long-range communications setup is this control board. Center telephone panel connects directly with tactical headquar-

ters, which normally would be some distance away. Receiving and transmitting antennas are also separated to avoid interference.

Wetter Water Helps Douse Fires

TO PUT out fires faster, fire departments now can get a chemical that, added to ordinary water, makes it "wetter." The chemical, produced by the American-La-France-Foamite Corp., of Elmira, N. Y., breaks the microscopic film normally sur-

rounding water droplets. Mixed one part to 100 of water, the chemical, called Penetrate, gives the water a fast-spreading and penetrating quality that strikes at the heart of deep-seated, smoldering fires. It is no more harmful to materials than plain water.

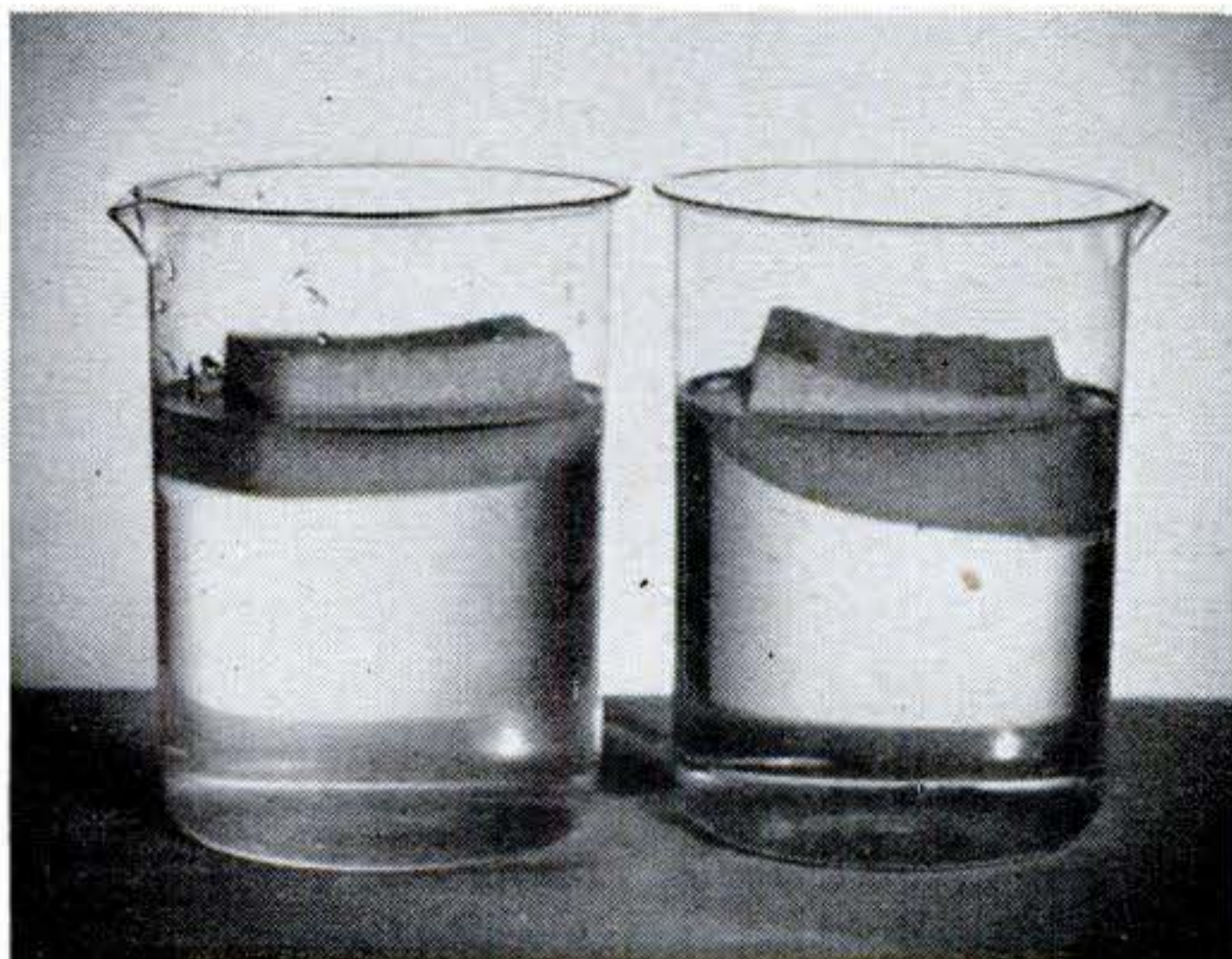

Artificial sponge, dropped in beaker containing ordinary water, got soaked but refused to sink all the way, as shown above.

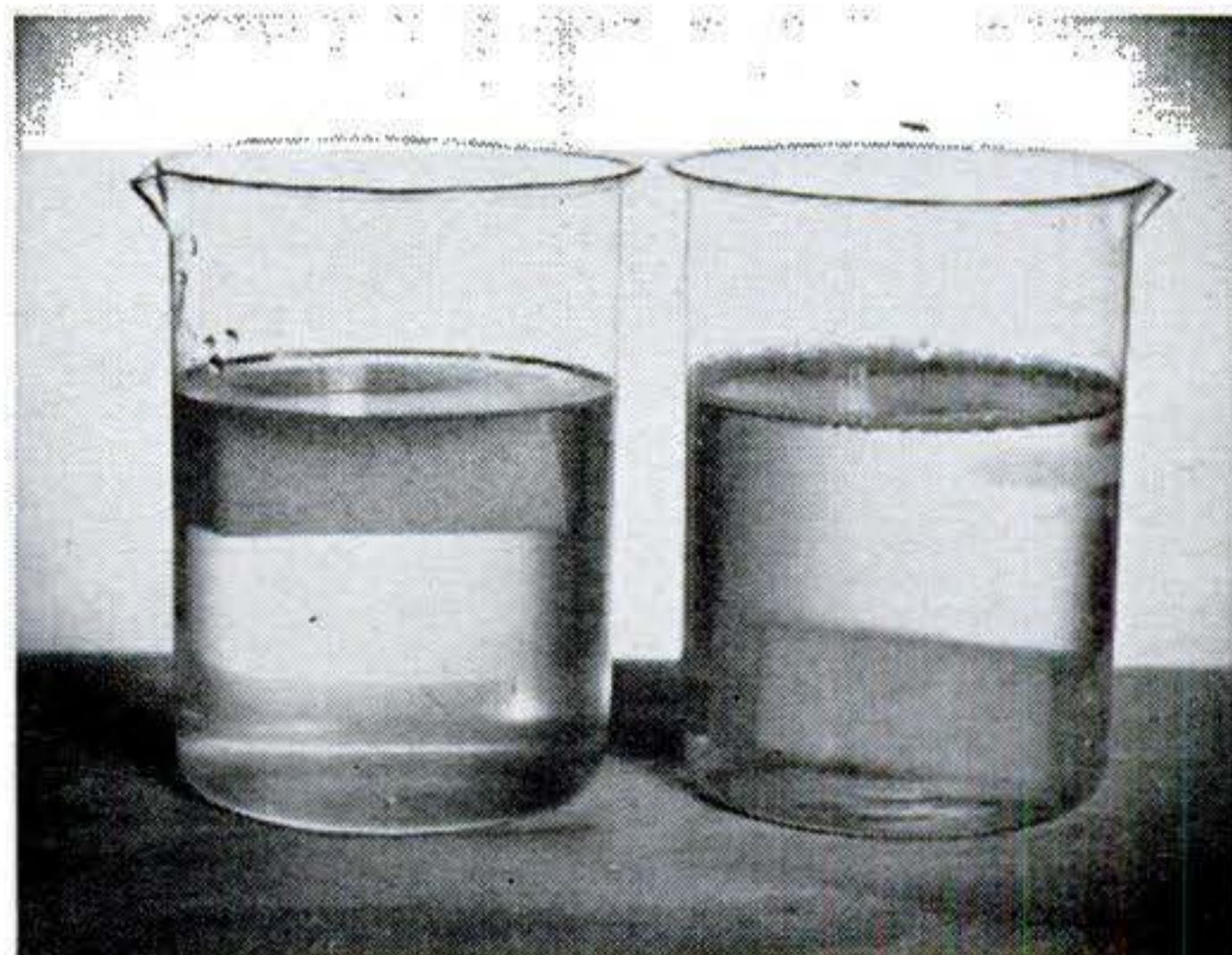

Similar sponge, dropped in wetter water, sank to bottom in three minutes because the chemical had broken surface tension of the water.



AIDS TO MODERN LIVING

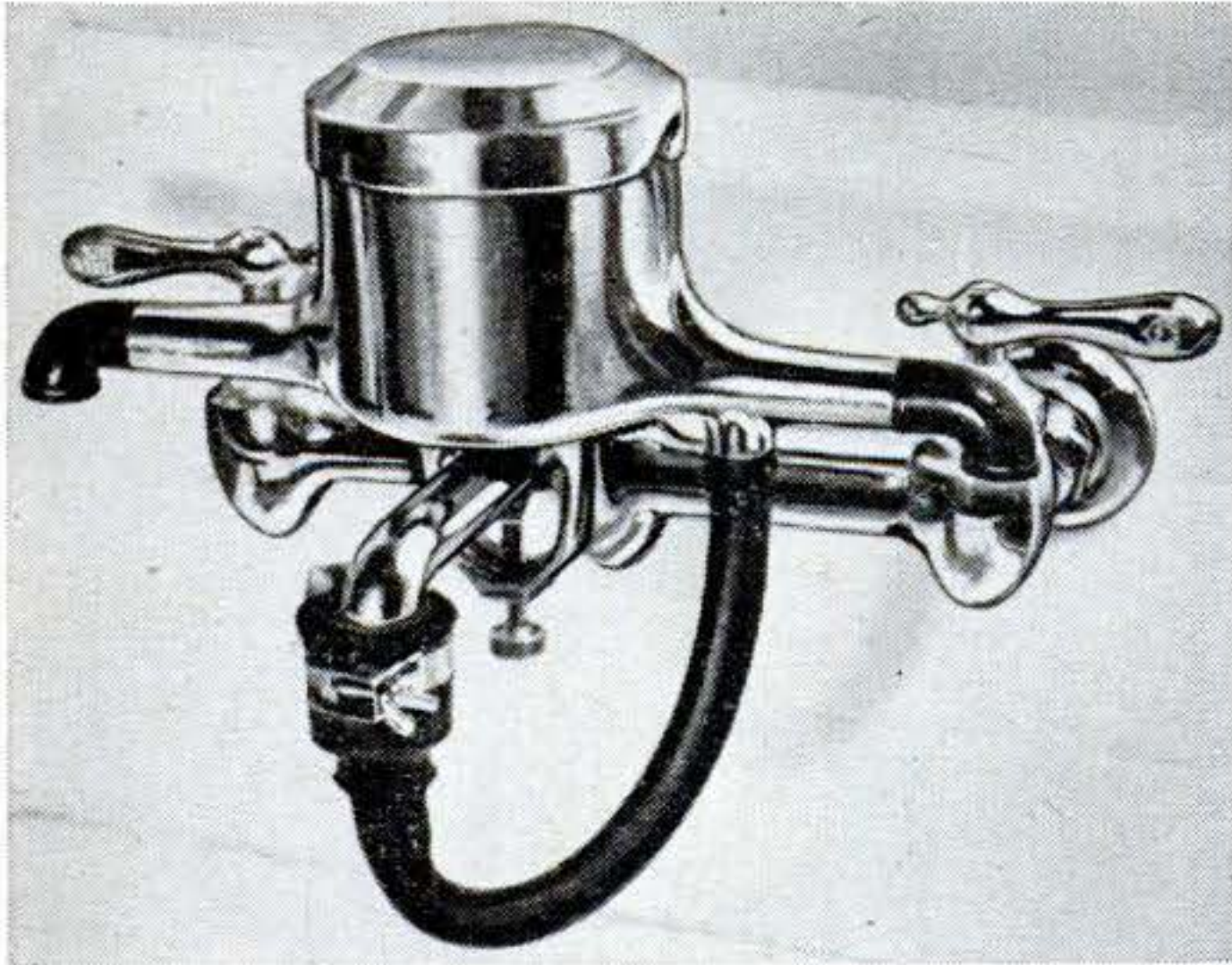

Washer Eliminates Dishpan. A new dishwasher introduced by Caldwell-Noel Corp., of Los Angeles, Calif., operates on any standard combination faucet. Soap is inserted and the water turned on to the desired temperature. Two streams of water emerge, one soapy for washing the dishes and the other clear for rinsing. Selling for about \$7, the washer is available in polished aluminum or in enamel in pastel shades.



It Blows Hot or Cold. Containing a heating element, this new oscillating heater-fan may be used to circulate either warm air or cooling breezes through a room. It offers a choice of two speeds and two temperatures, can be set to oscillate or remain stationary, and may be tilted on its base by the turn of a knob. Priced at about \$22, the appliance is a product of the Wittie Manufacturing & Sales Company, of Chicago.

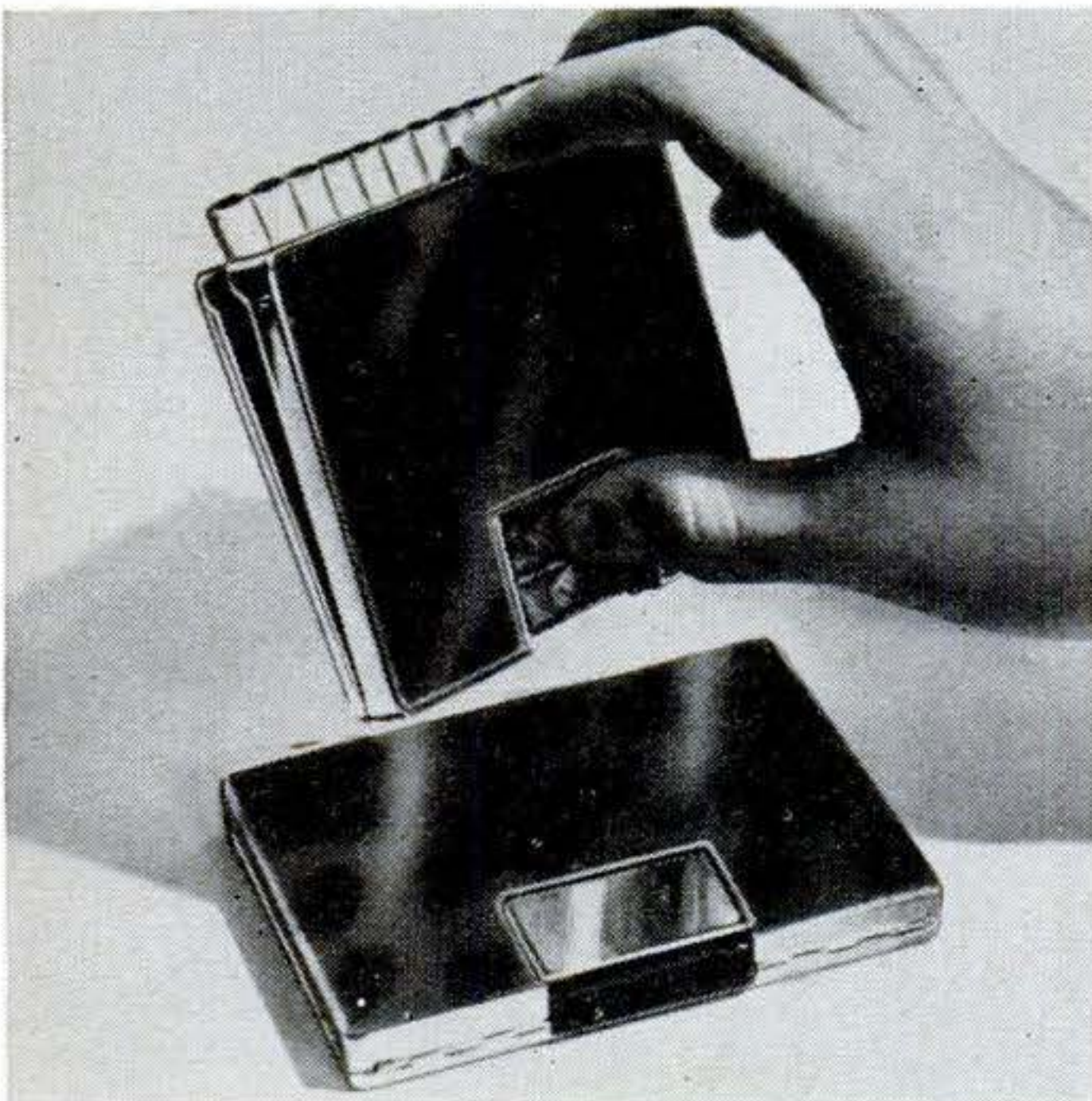

Cigarettes Pop Out. Upward pressure on a thumb plate snaps open this cigarette case and lifts a carrier that forces the cigarettes up so they may be easily grasped. When pressure is removed, a spring returns the plate to its original position. The case, priced at \$9, is a product of the Arthur C. Sogno Co., of New York.

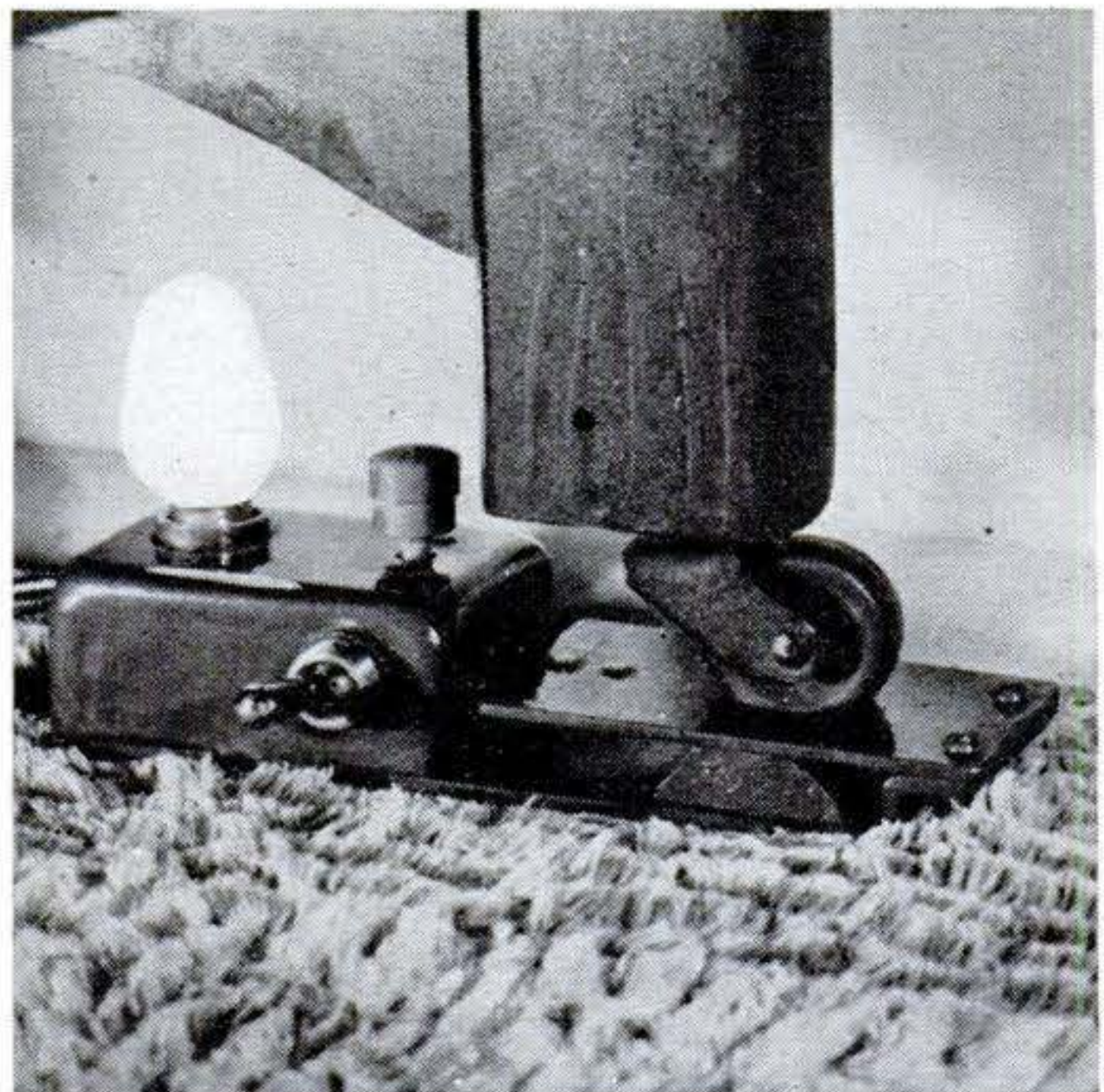

Light Shines When You Rise. If you get up at night, removal of your weight from the bed permits a spring-actuated switch to turn on this light. When you return to bed, it turns off again. The device, adjustable to the sleeper's weight, is made by the Rise N Shine Company, San Diego, Calif. It may be turned off during the day.



Device Grips Hot Pans. Operated like a pair of pliers, this stainless-steel kitchen tool is designed for easy handling of hot pans or plates. Priced at about \$1, it is made by the Taylor Products Manufacturing Company, of Colorado Springs, Colo.

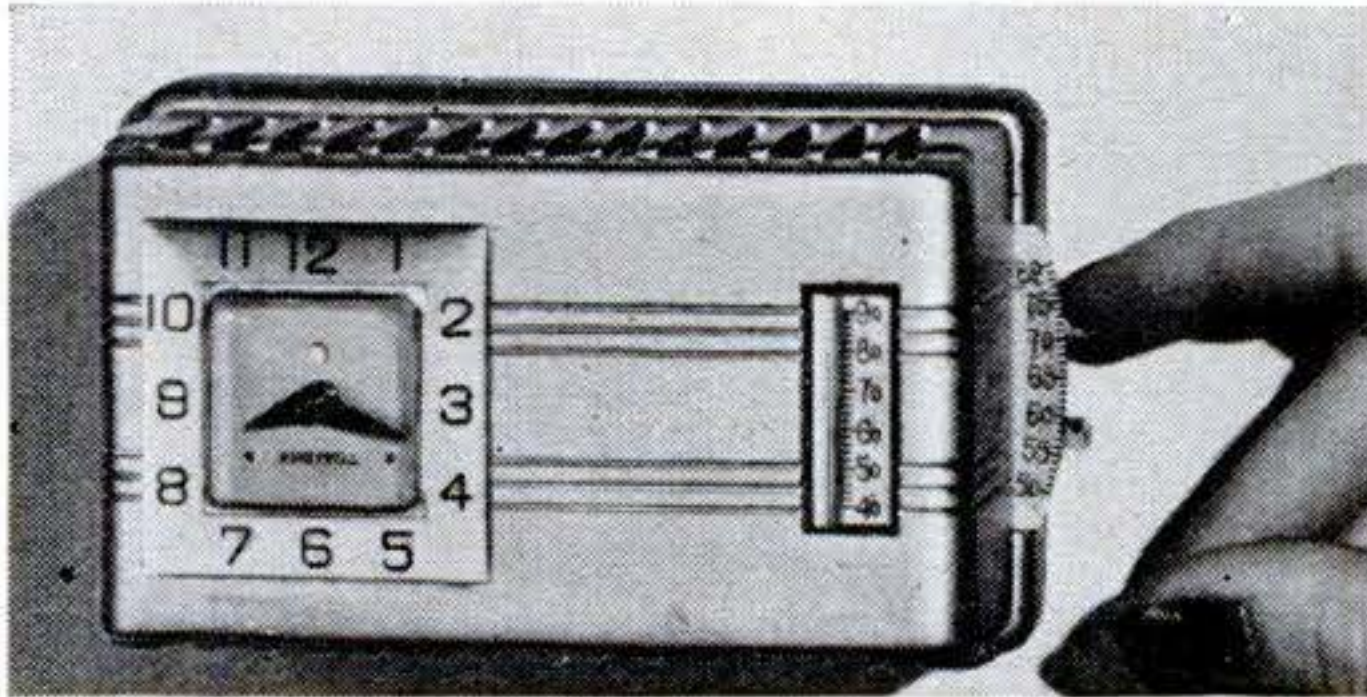

Thermostat Saves Heat. Fully automatic, a time-control thermostat announced by the Minneapolis-Honeywell Regulator Company, Minneapolis, Minn., includes a new electrical mechanism that prevents the heater from overshooting the daytime temperature limit during the morning. External controls permit easy setting.

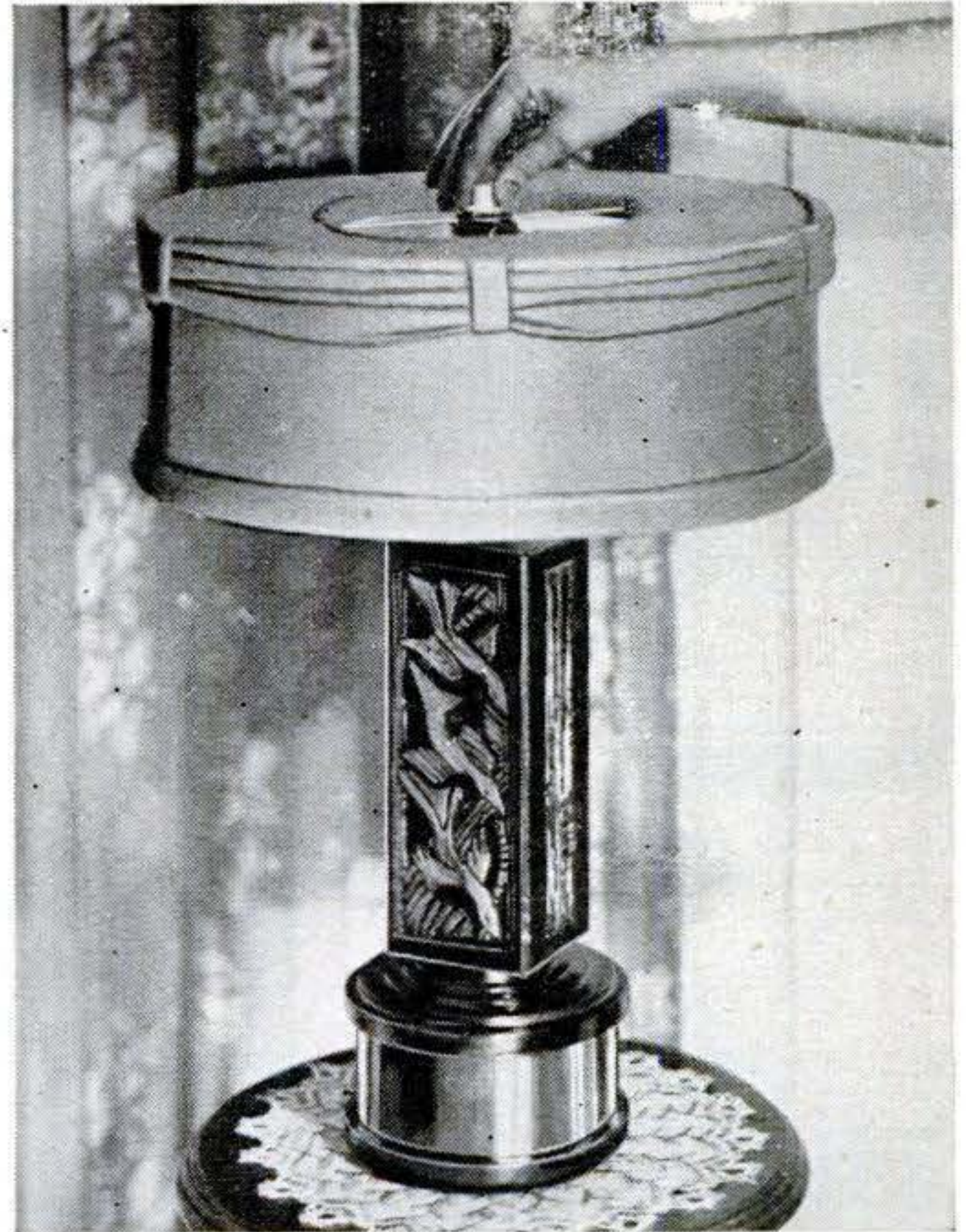

Lamp Has Switch on Top. A table lamp made by Homecraft Electronic Products, of Chicago, has the switch conveniently located on top of the shaft, eliminating the need of reaching under the shade. Using a circular 32-watt fluorescent tube for diffused light, the lamp has a brass base and wood shaft. Various shades are offered.

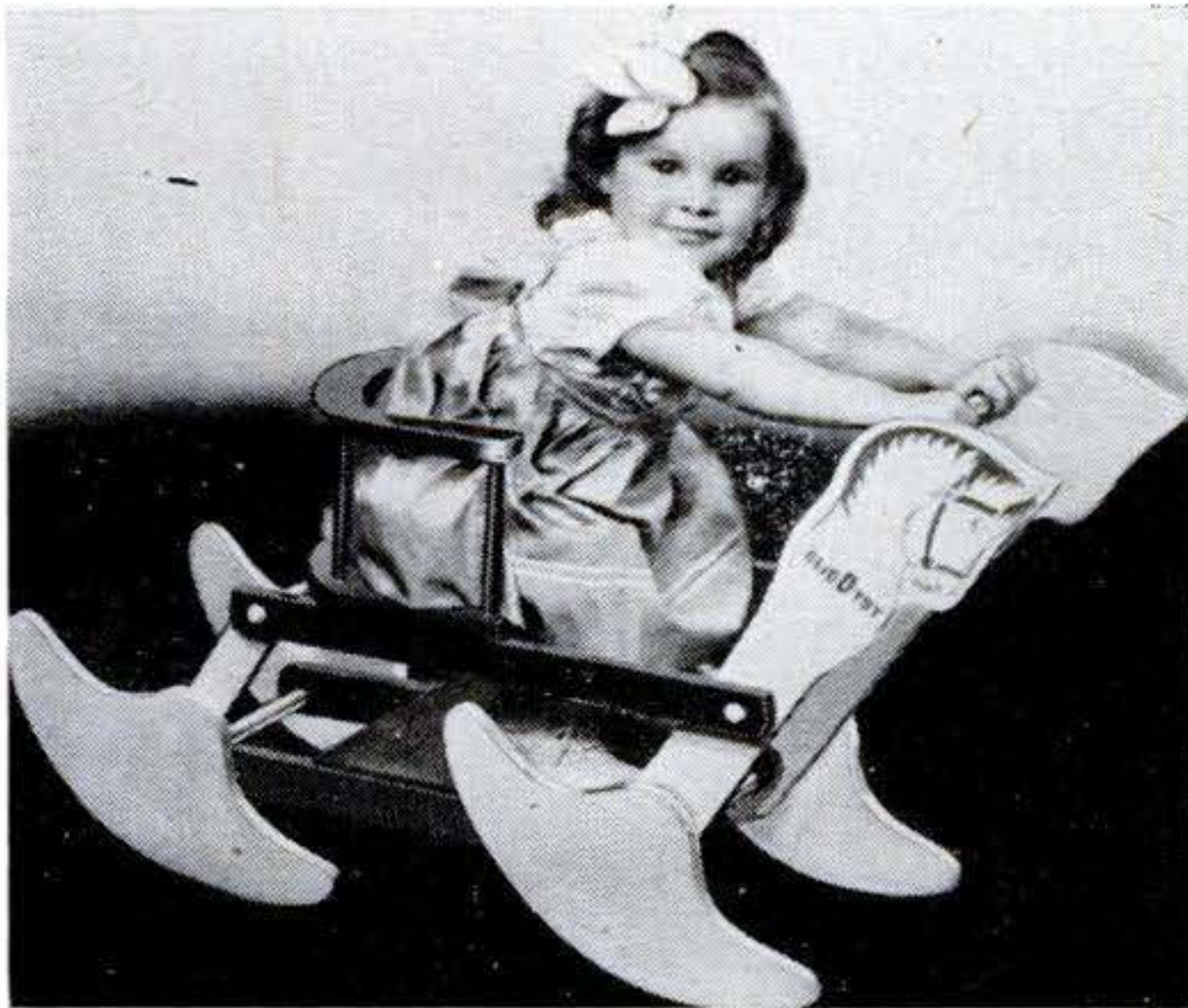

Toy Has Three-Way Action. This wooden rocker is designed to give a child an active ride. When the arms set the rockers in motion, the feet move up and down with the platform on which they rest, and the seat glides back and forth. The rocker is built by Hall Industries, Inc., of Chicago. It costs approximately \$9.



Stand Turns Yule Tree. Powered by a small AC motor, this stand not only supports a Christmas tree but turns it at the rate of three revolutions a minute. In addition, a special device supplies current to sets of tree bulbs while the tree is turning. The stand is produced by the General Die and Stamping Co., New York.

Most Flats Are Your Own Fault

By R. P. Stevenson

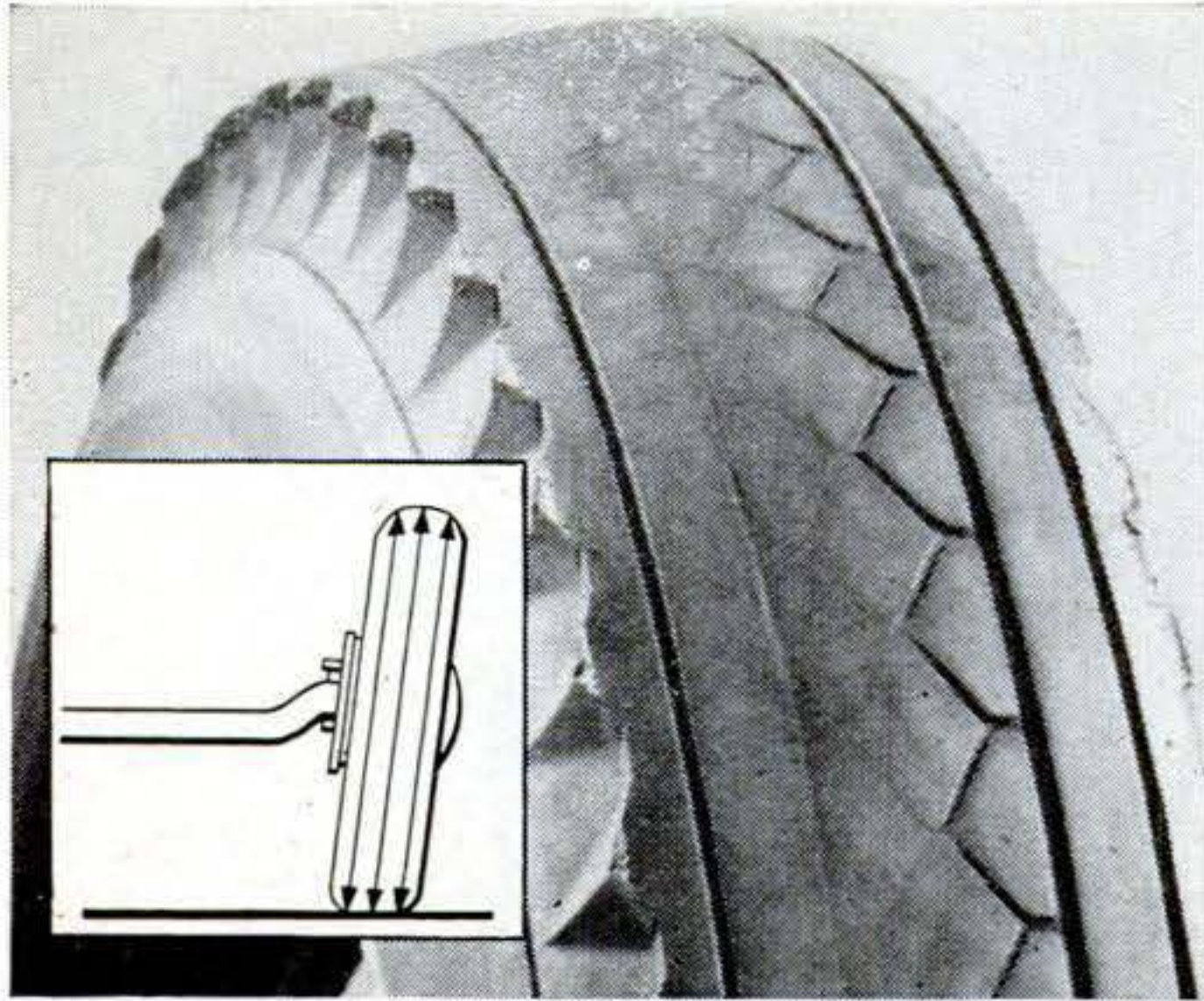

Excessive camber wears the tread away along the outer edge. When a tire shows wear like this, or as seen in the two photos below, an alignment job on your wheels is long overdue.

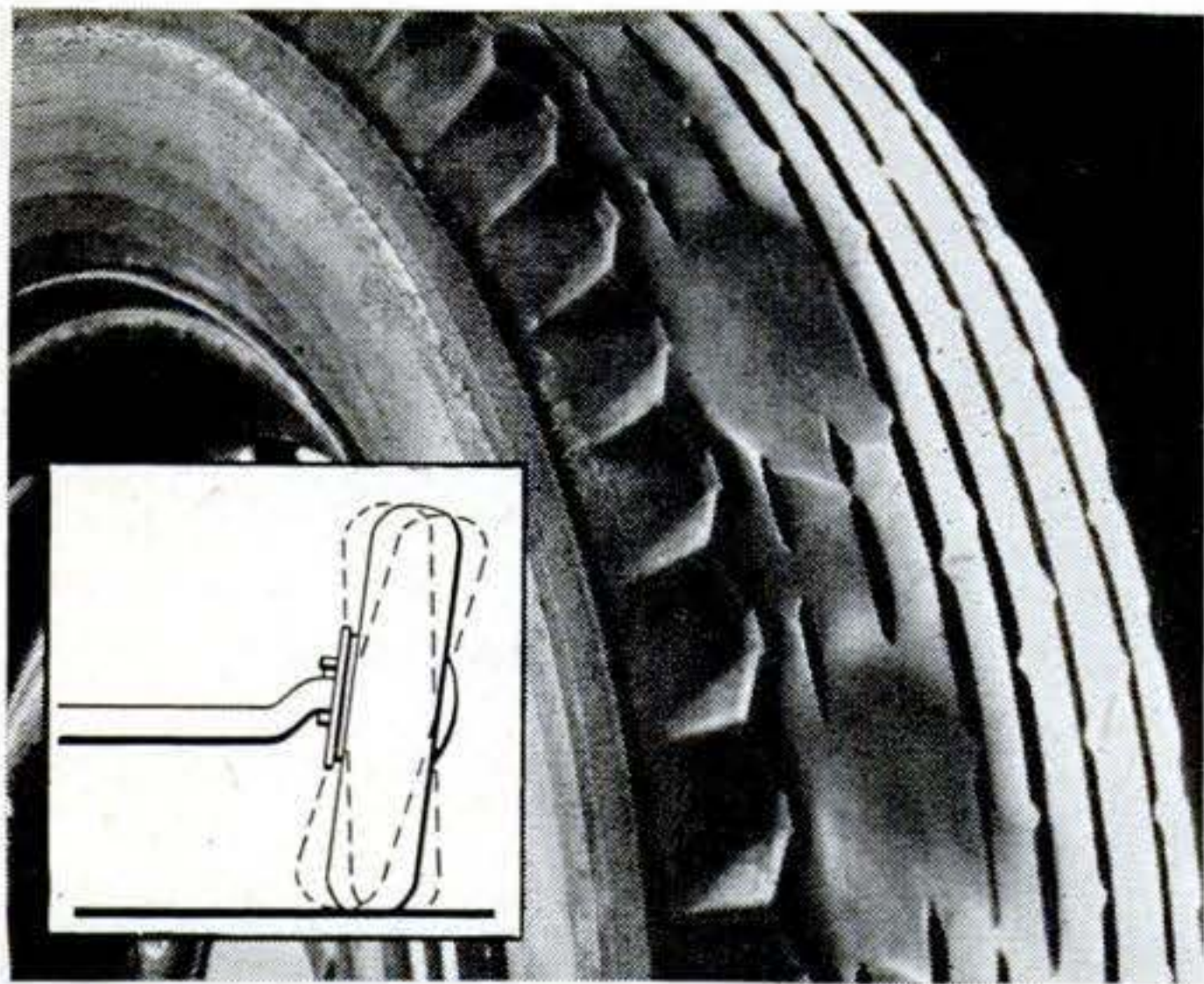

Wobbly wheels resulting from such mechanical defects as a bent axle or uneven caster soon make a tire look like this, flat spots being worn in the tread at irregular intervals.

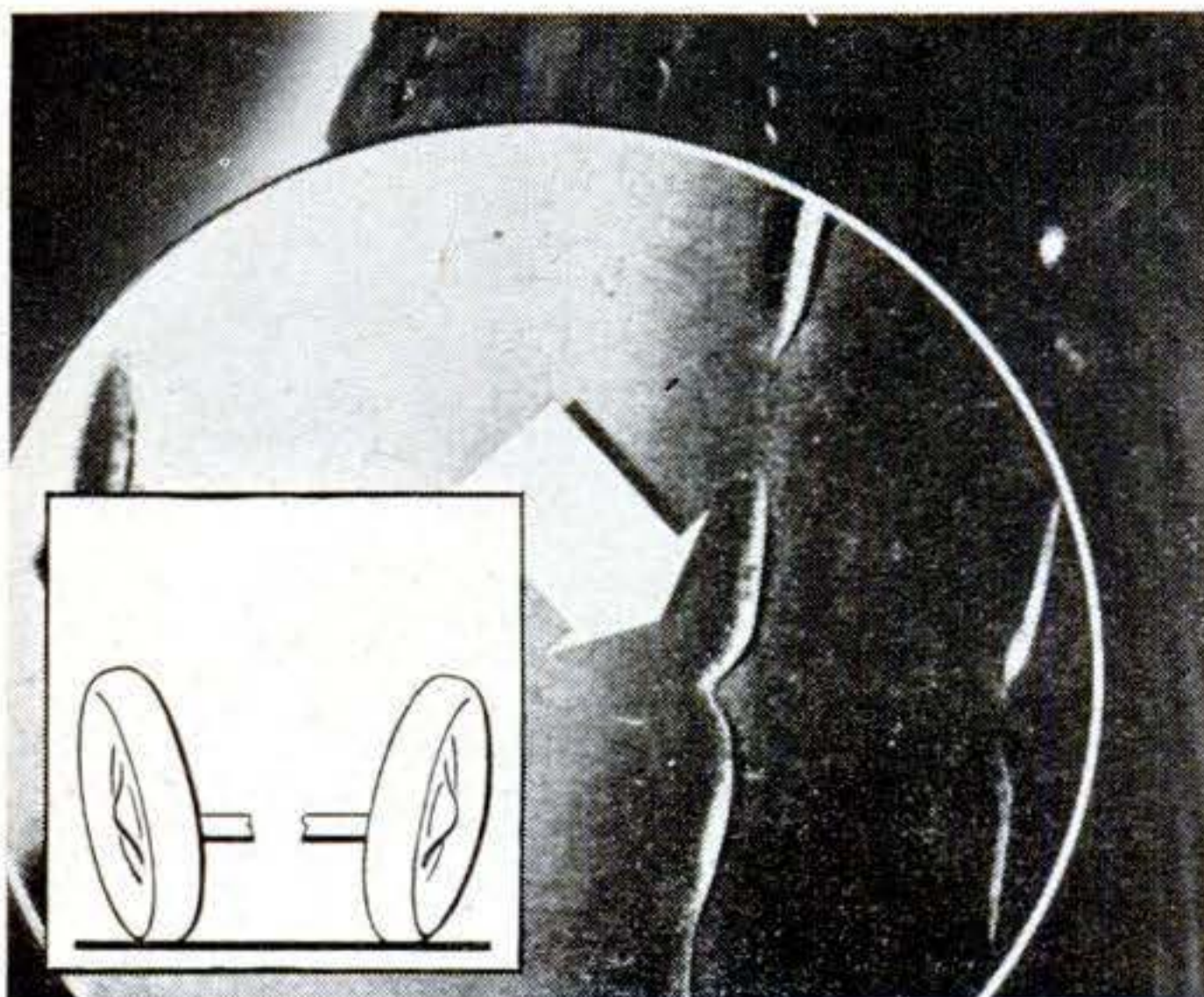

A **feather edge** of rubber on front-tire treads is a sign of wrong toe-in or toe-out. A wheel $\frac{1}{2}$ " out of alignment drags the tire sideways about 67' every time the car travels a mile.

WHEN one of your tires goes suddenly flat along the highway, perhaps miles in the country on a dark and blustery night, it's a pretty safe bet that you might have detected the impending trouble and taken steps to prevent it. There's evidence to prove that some 90 percent of all such inconvenient tire failures can be avoided.

This doesn't mean you must scan every inch of the roadbed ahead for nails and tacks. Anyone is apt to puncture a tire now and then, and even the most careful driver occasionally bumps a rock or curb with sufficient force to break the fabric. Such damage almost invariably results in a flat. But—and this is a fact that drivers often fail to realize—complete failure may not come for days, and perhaps weeks. In the interval, there usually is ample opportunity to detect the symptoms of forthcoming failure and repair the tire before it hangs you up along the road.

Tires are built to give their maximum mileage under operating conditions over

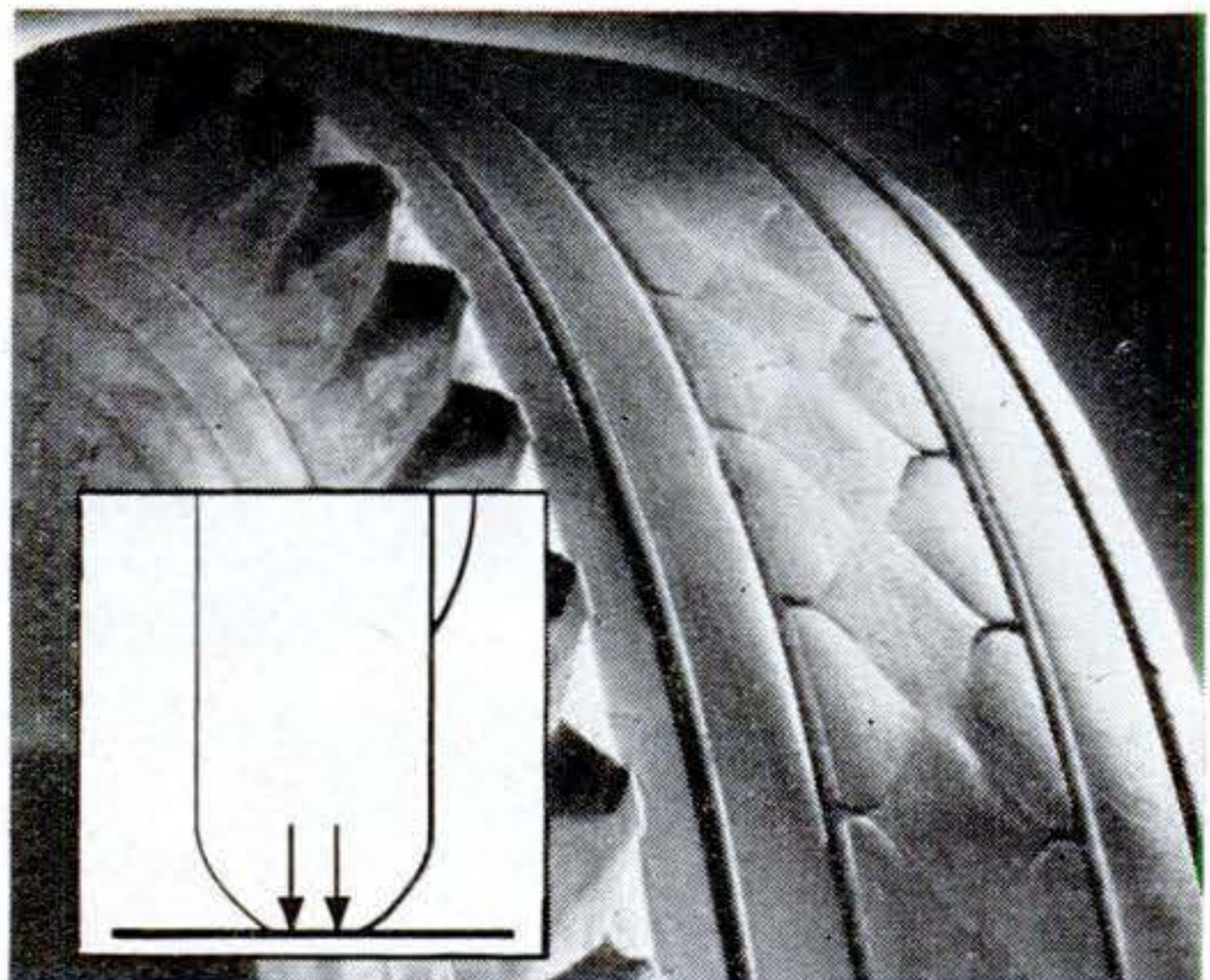

Overinflation wears the tread in the center, leaving the fringes in fairly good condition. Because of abnormal tension, such a tire also is more susceptible to cuts and tread breaks.



A streak of worn rubber behind one wheel of a stopping car means the brakes are unequalized.

which the individual driver has direct control. Basically, these are proper inflation, correct wheel alignment, proper adjustment and **efficient use of brakes**, and avoidance of damaging road obstacles. Carelessness about any of these points may quickly ruin a tire. Examples of such damage are illustrated on this and the preceding page.

When a tire has been badly worn or damaged because of one of these reasons, it may of course go flat or blow out without warning. But suppose a comparatively new and

apparently undamaged tire fails unexpectedly? What then?

In such cases, you may be sure that, barring a leaky valve or the slim chance of a manufacturing defect, the flat occurred because the tire, or maybe only the tube, was damaged in some way during operation—usually quite a while before the failure.

This fact may be turned to your ad-

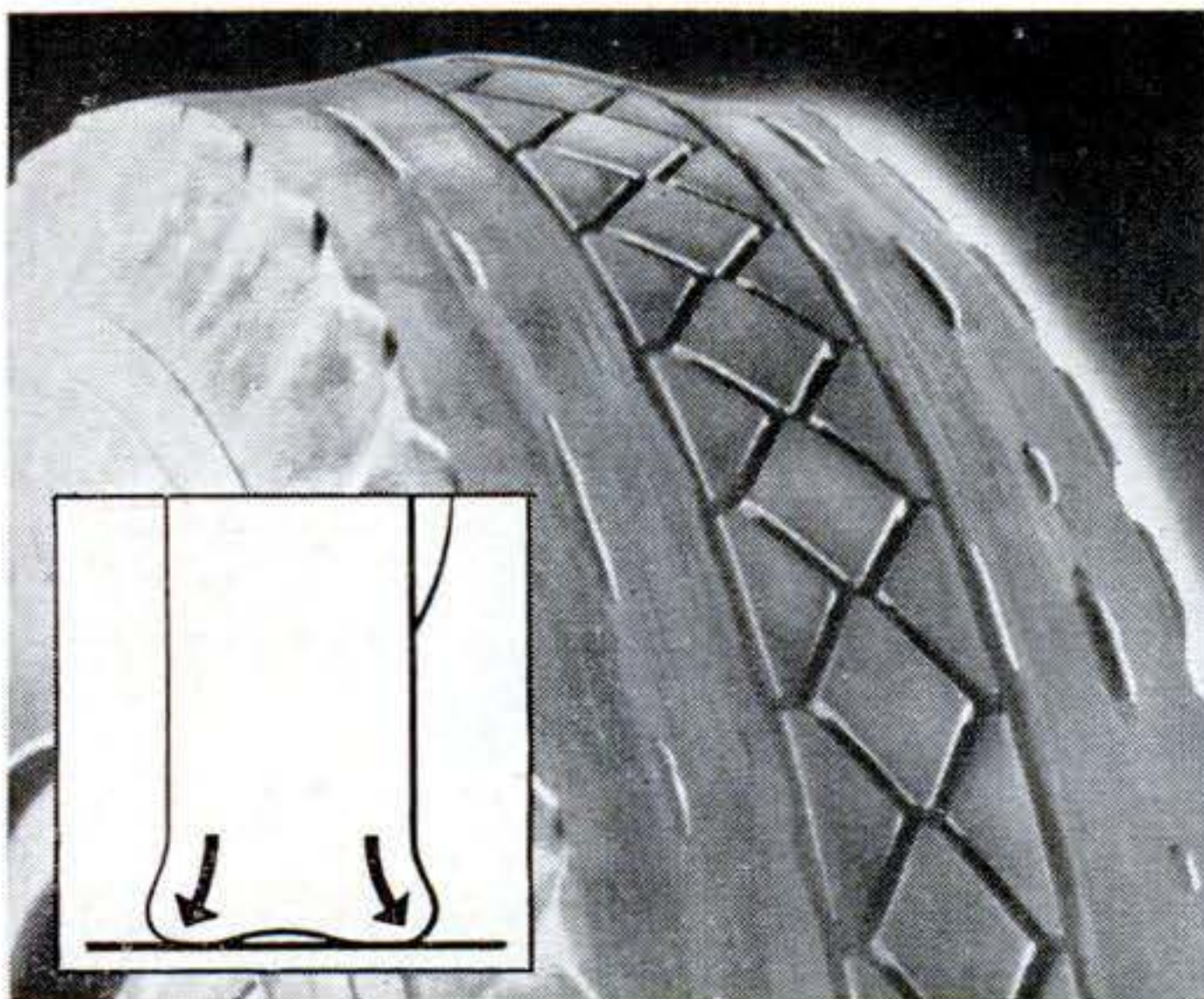

Underinflation, especially if it is excessive, may have this unexpected result—heavy wear only on the shoulders. For the cost of underinflation, see the chart on the next page.

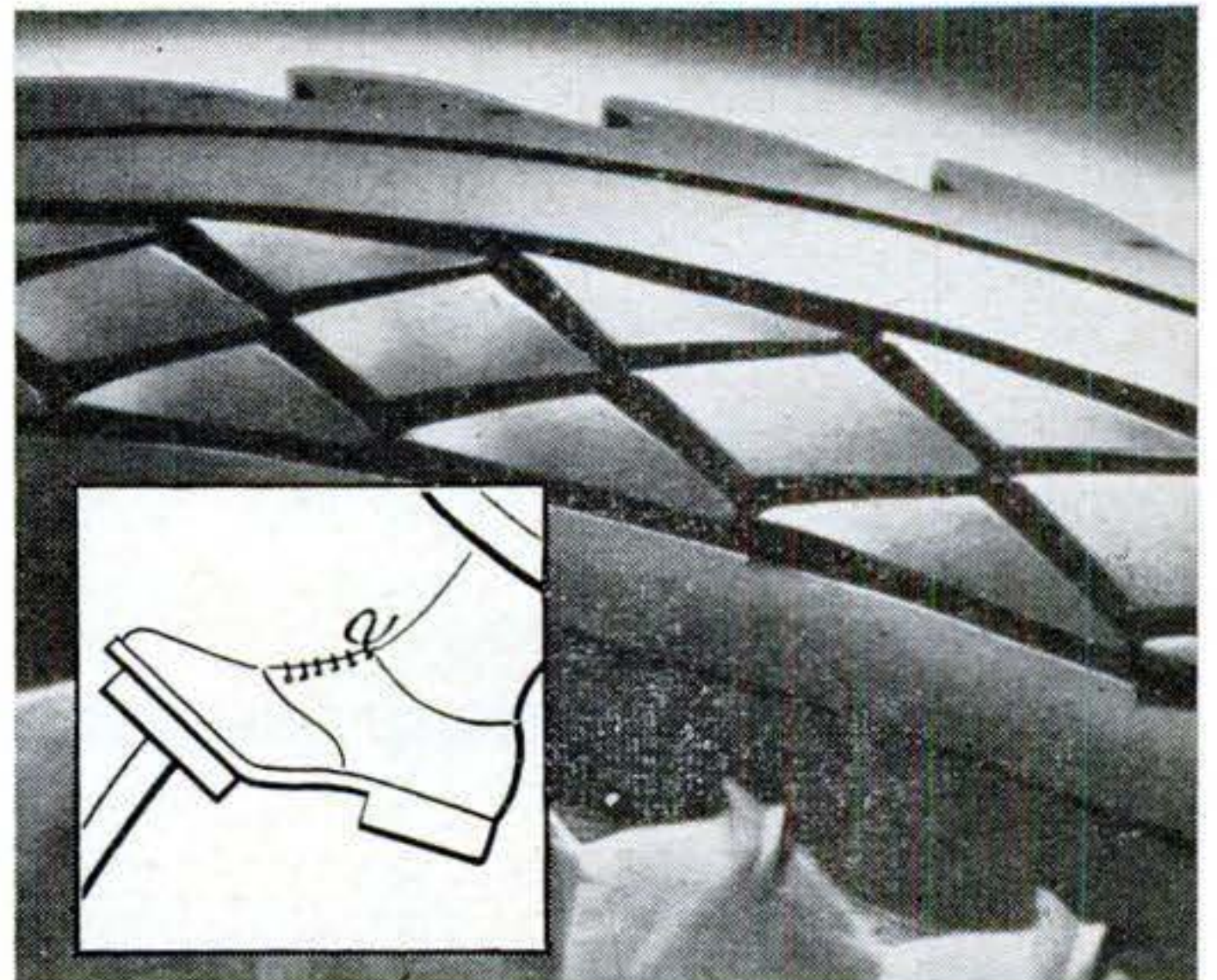

Sudden braking causes one end of each tread button to wear more than the other, heaviest wear occurring on the end that first contacts the road. This is known as heel-and-toe wear.

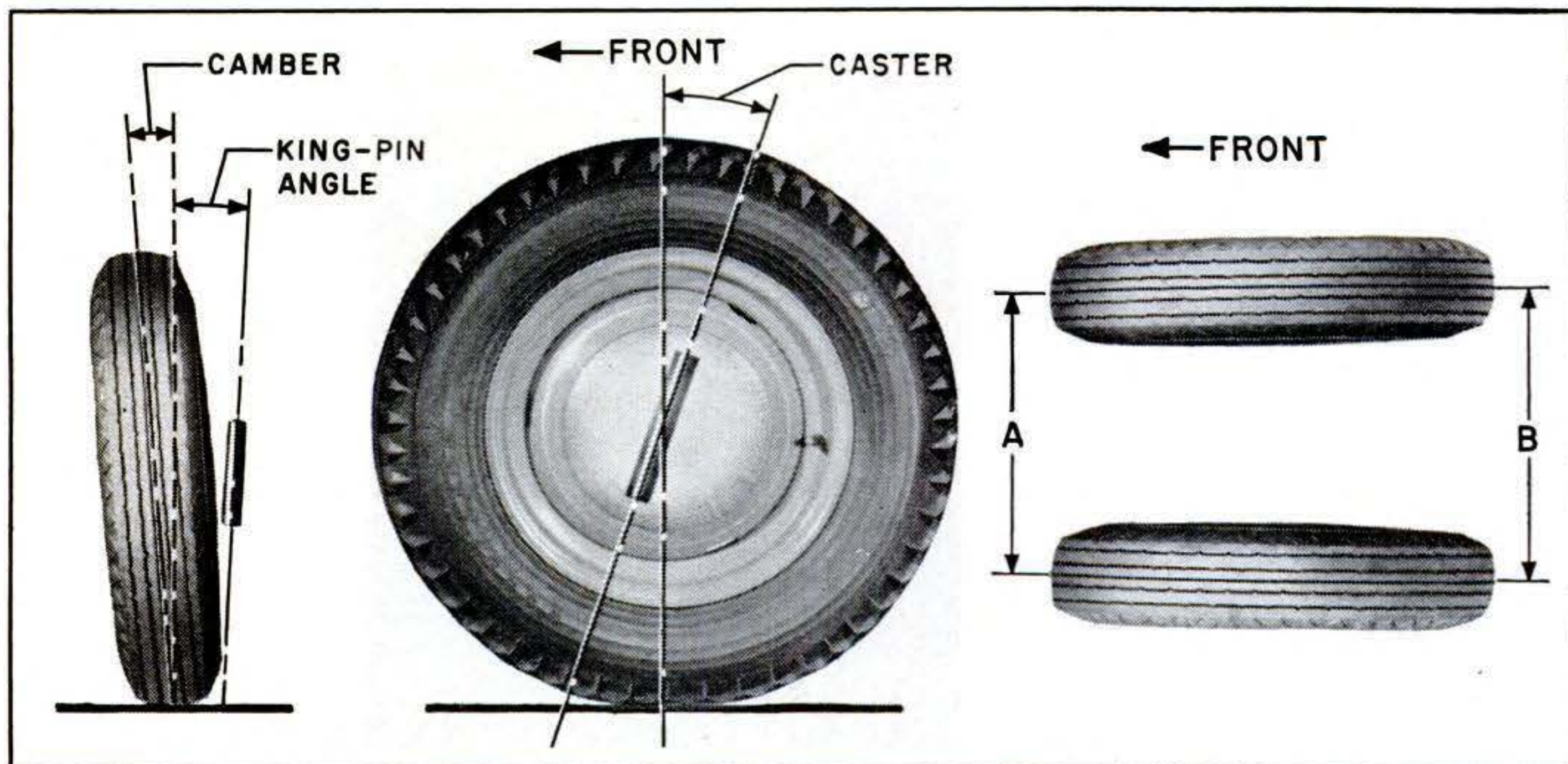

Steering geometry involves proper relationship of camber, caster, king-pin angle, and toe-in

(which requires that A be less than B.) If any element is off, undue tire wear will result.

vantage. It is the basis of a method of preventive maintenance developed by A. Schrader's Son, of Brooklyn, N. Y., a division of the Scovill Manufacturing Company, Inc. Called the "Comparative Air-Loss System," this method of preventing tire failure emphasizes that any excess loss of pressure, as shown by regular gauging, should be regarded as a warning that the tire has been damaged and will eventually go flat.

The system embraces four points:

1. Gauging of tires when they are cool, once each week before adding air.

2. Recording and careful comparison of the pressures. If the pressure of one tire is 3 lb. below its running mate, there probably is a leak in the tube, and the cause should be immediately determined.

3. Keeping a valve cap firmly applied at all times, not only to prevent air loss in case the valve is faulty but also to restrict any source of leakage to the tube.

4. Removal of foreign objects from the tire surface when the car is lubricated.

Originated during the war as a tire conservation measure, the system was featured

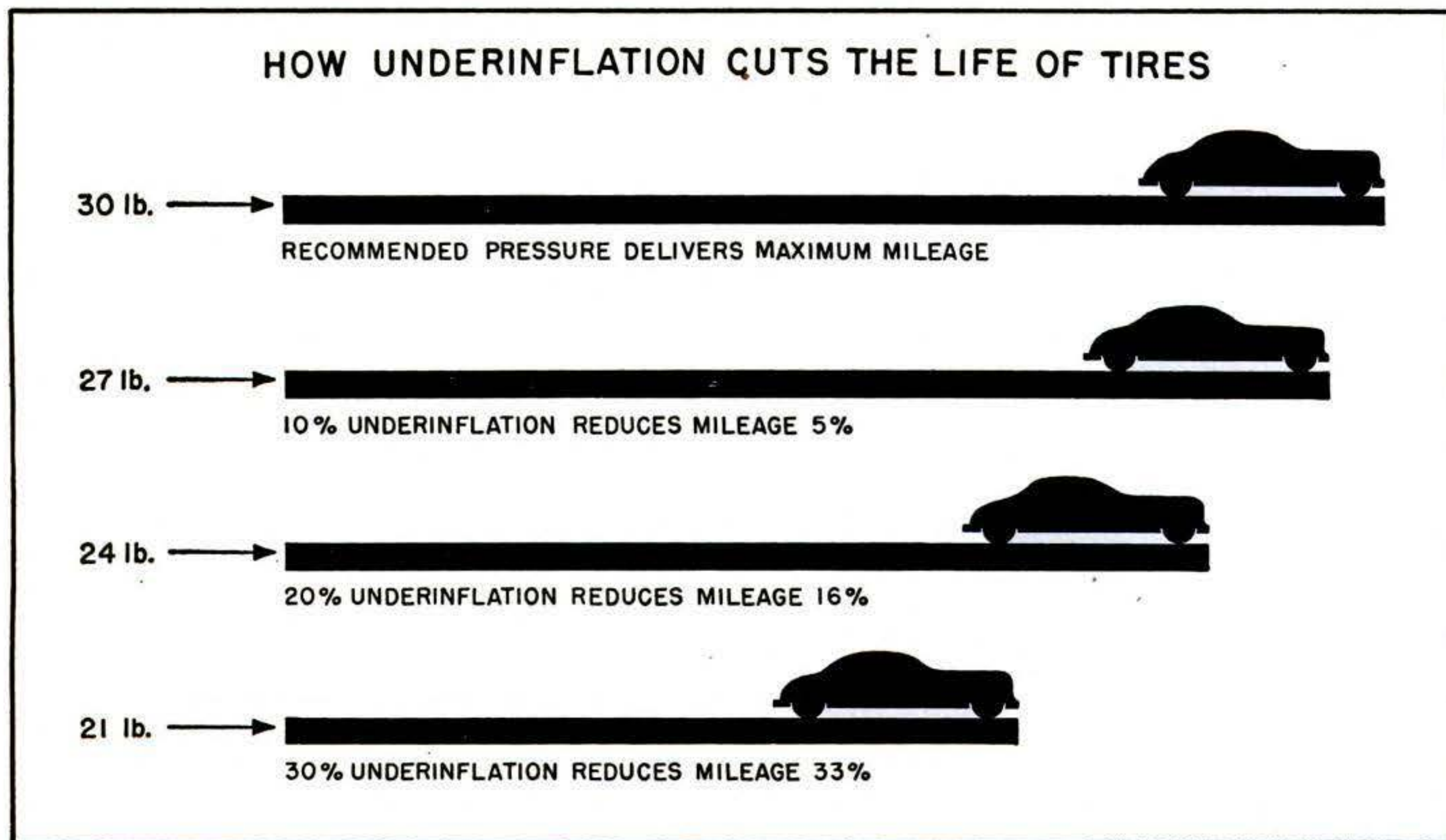

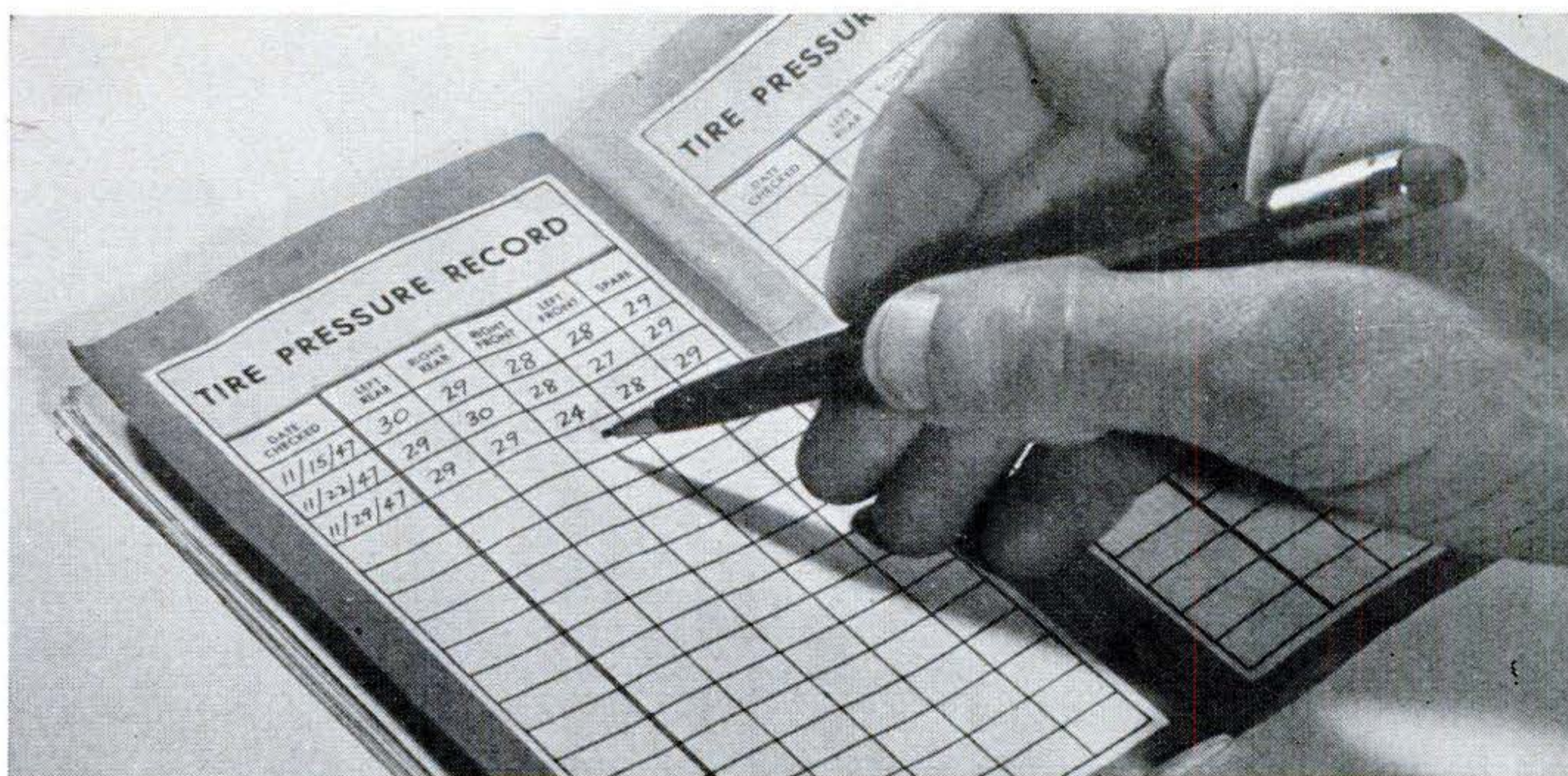

Warning of a flat tire is contained in this record. The excess pressure loss in the right

front tire indicates a slow leak. If a flat is to be avoided, this tire should be checked at once.

in a bulletin distributed to branches of the armed forces and to bus and truck fleet operators. That it produces results is shown by the experience of one company operating a fleet of trucks. Before adopting the system, the company had an average of three flats a day. Subsequently, the same trucks ran for six months and one day, a total of 236,000 miles, before the first roadside flat occurred.

The system can be applied to passenger cars with equal results, and a test on a 1946 model, reported by the Schrader company, shows why. At the beginning of the test, the car still had the original tires and tubes and already had run 11,284 miles. While cool, the tires were inflated to 28 lb. Then, 20 nails were deliberately driven into the four tires, and the car was started out on a test run at above average speed. At the end of five days, the tires were reinflated to 28 lb., after first being gauged. At that time, despite the presence of the 20 nails, the greatest air loss for any tire was 10 lb. On each day thereafter, the tires were brought back to 28 lb.

Finally, after the car had been driven 1,051 miles, one tire dropped from 28 to 10 lb. pressure, and then went completely flat after the car had been standing about 10 minutes. The second gave out at the end of 11 days and the third after 16. It was not until the 18th day, after 1,844 miles of driving, that the fourth suddenly went flat on the road. If any one of these tires had been punctured accidentally, the excessive

amount of air required to keep it properly inflated should have been taken as a warning.

One important point to remember in applying the air-loss system is that tires should be gauged and inflated only while they are cool; that is, at atmospheric temperature. During operation, normal flexing of a tire generates heat, and the heat causes the pressure to increase, possibly several pounds. If a tire is inflated—or deflated—at this time to what is assumed to be correct pressure, it will be underinflated when cool.

To make the air-loss system work to your best advantage, it is therefore advisable to have your own hand gauge and use it before moving the car from the garage. Then, if no tire shows an excessive loss, you can drive to a filling station and bring them up as needed. But if one does show a sudden drop, better investigate at once. **END**



Gauge your tires weekly, taking the reading after the car has stood at least two hours.



AUTO IDEAS

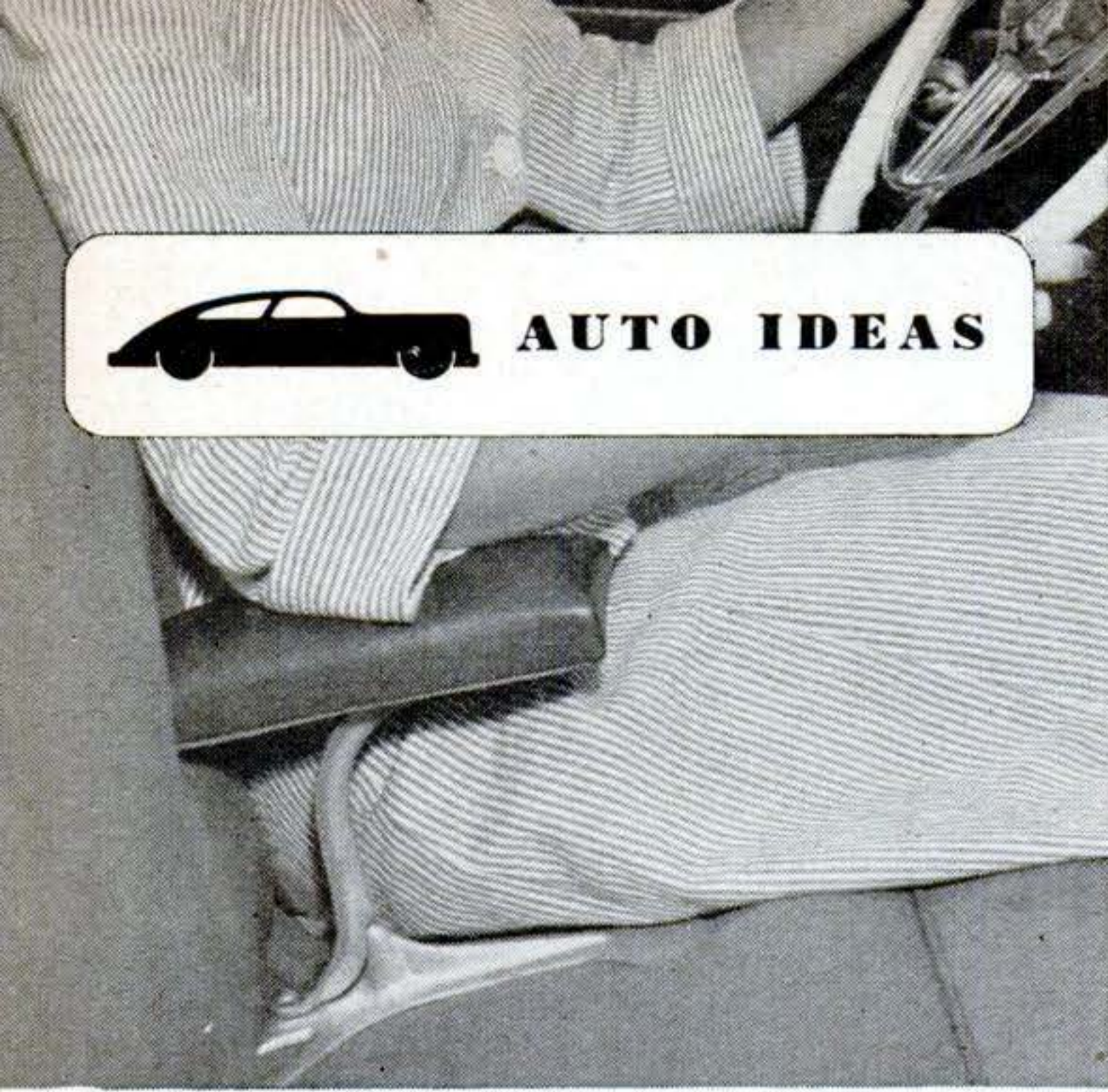

Arm Rest Is Removable. Although designed particularly to support the driver's right arm on long trips, this arm rest also may be used by a passenger in either the front or rear seat. If turned sideways, the foam-rubber cushion also doubles as a high chair for a youngster. A broad metal base keeps the rest upright while in use. Manufactured by the Perlin Perfect Products Company, of Chicago, the rest sells for about \$3.50. It stows away compactly when not in use.

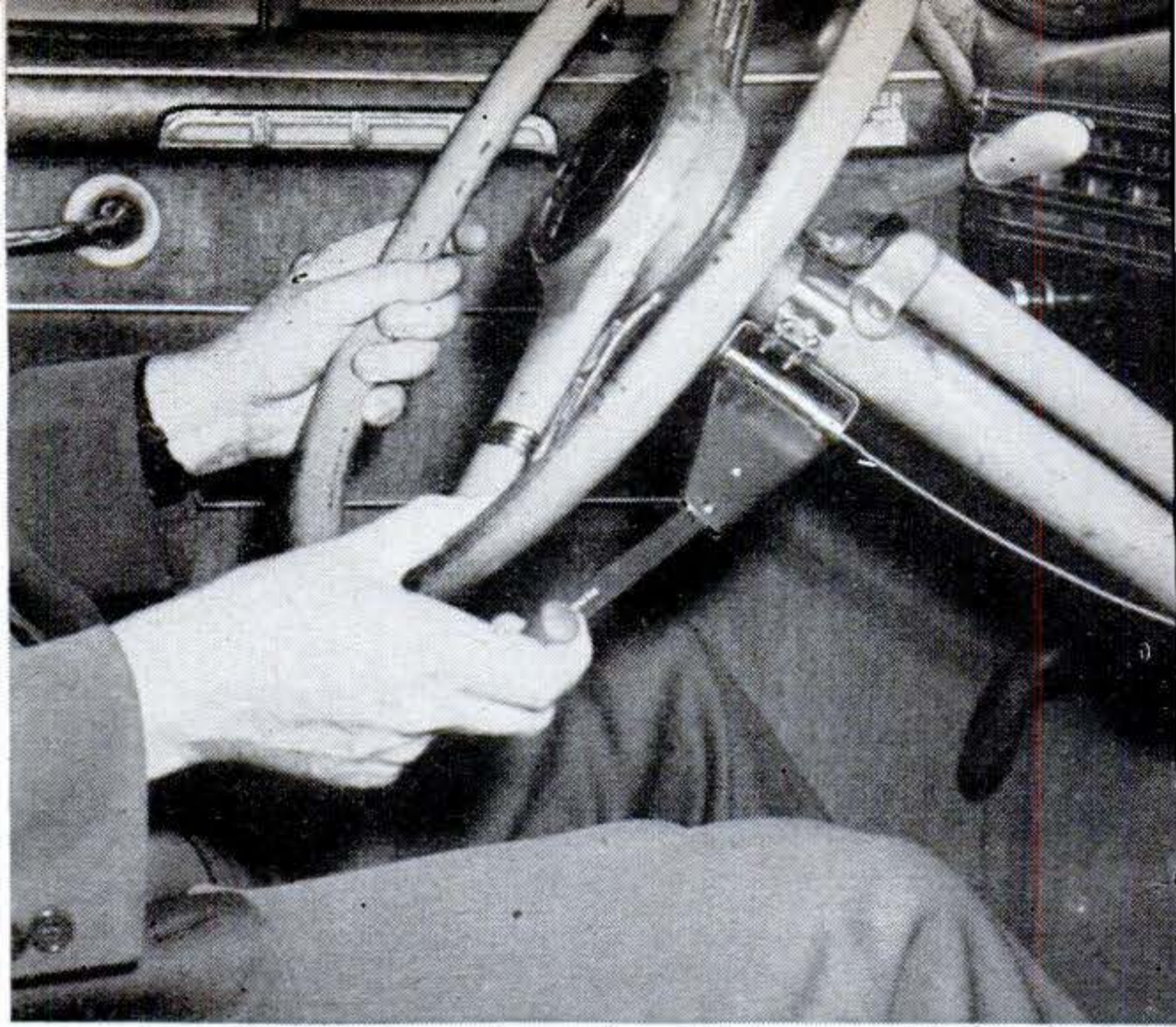

Hand Throttle Rests Foot. Pivoted under the steering column so it may be swung right or left for use by either hand, this hand throttle is connected to the carburetor by a flexible wire and may be used interchangeably with the foot accelerator. The throttle is placed so that it does not interfere with operation of the gear shift, gas being fed by drawing the lever gently upward toward the steering wheel. Made by Trans Continental Industries, Inc., of St. Louis, Mo., it sells for about \$6.

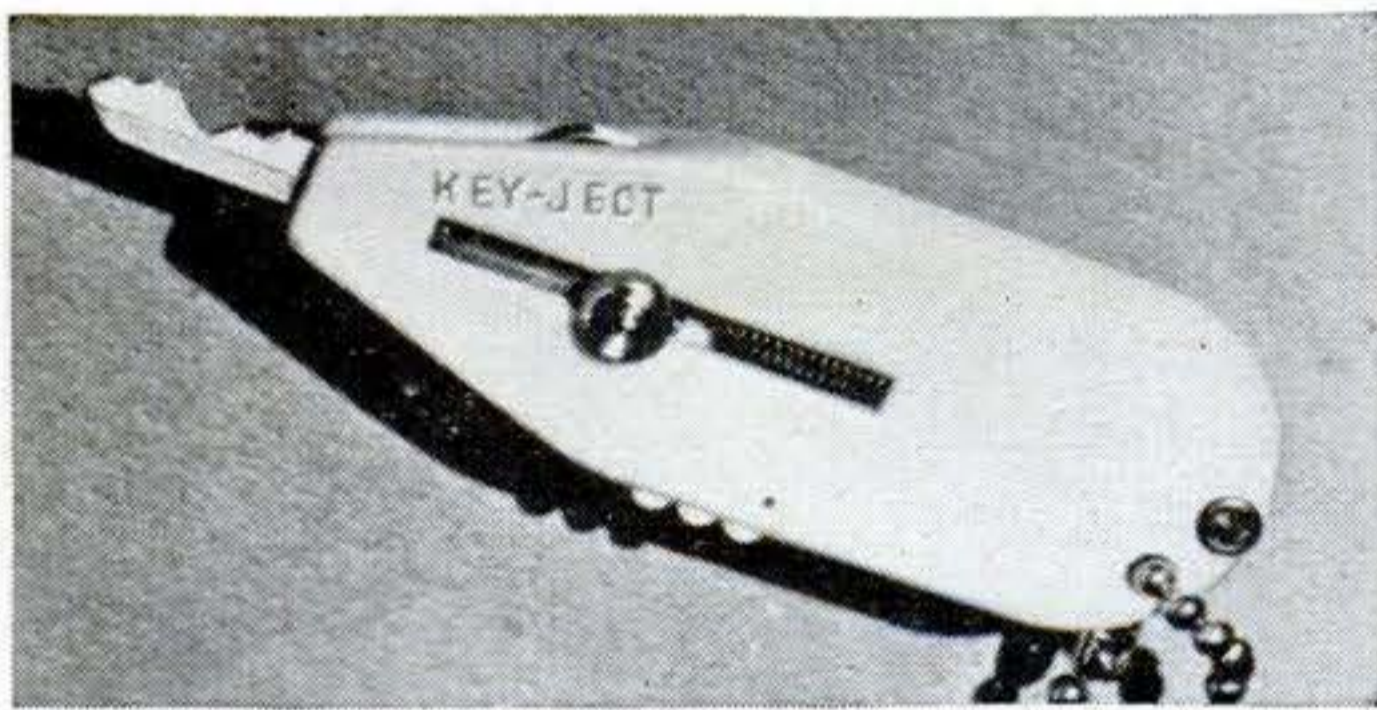

Key Springs from Lock. Designed to prevent drivers from leaving the ignition key in the lock, a key case manufactured by Robert Hetherington & Son, Inc., of Sharon Hill, Pa., contains a spring that causes the key and case to spring out into the hand as soon as the ignition is turned off. It retails for about 40 cents.

Caution Sign Reflects Light. A caution sign introduced by Strayline Products Co., of Dobbs Ferry, N. Y., measures 9" by 24" and stands 24" high, but it may be collapsed into a compact bundle for storage. Made of aluminum, the sign has reflecting letters that are clearly visible up to 250' at night. It sells for about \$3.

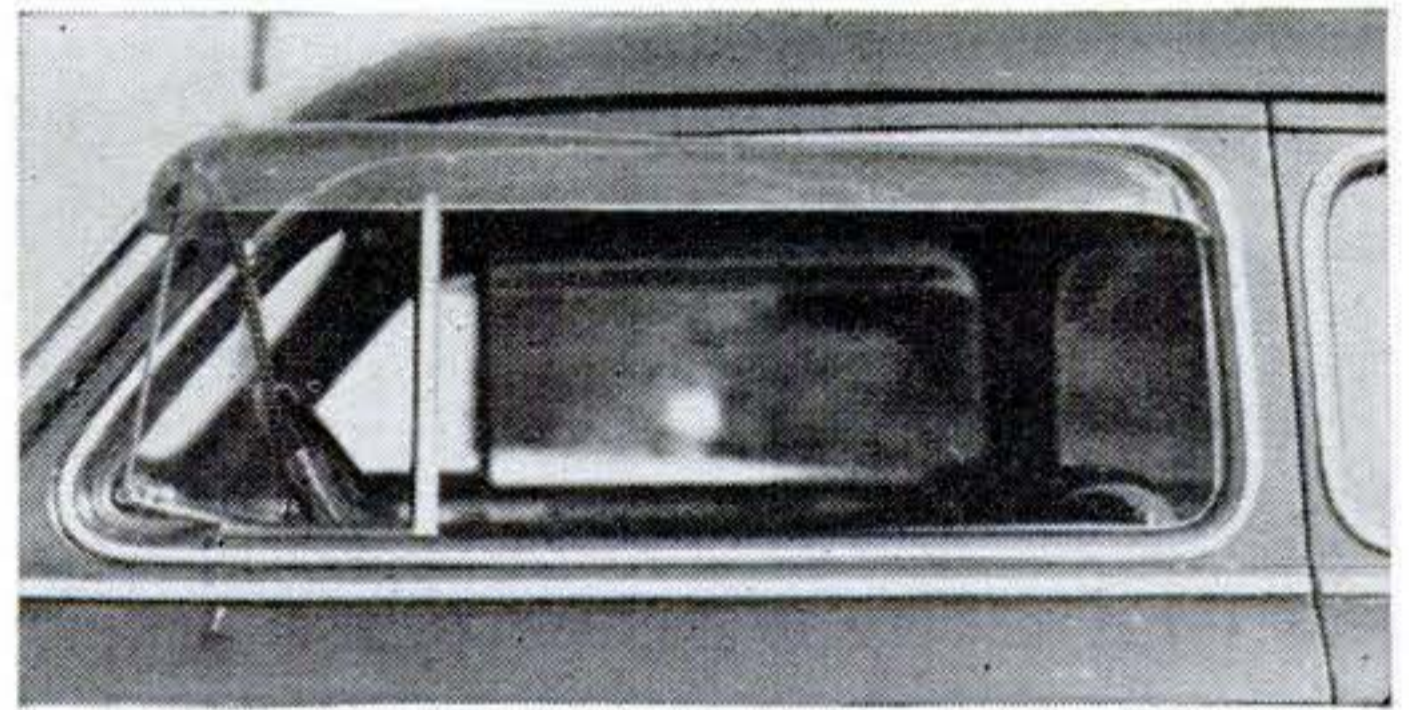

Awnings Are Transparent. Made of transparent plastic in blue or smoky green, these car-door awnings provide shade without materially reducing the visibility. In addition, they afford protection from rain and snow. Introduced by the Toadroy Manufacturing Co., of Wellington, Kan., they sell at \$13.50 to \$19 a pair.





AUTO HINTS

1. How to Thaw a Radiator. Hot water poured against a frozen radiator in a narrow path from top to bottom directly over the lower hose connection will thaw a strip 2" or 3" wide and restore circulation. When the motor is started, the hot water inside the thawed tubes will soon free the entire radiator. A length of hose slipped over the kettle spout will enable you to reach inaccessible spots.—E. R. WALSHAW.

2. Belts Serve as Chains. Heavy V-belts wired to a wheel as illustrated work well as emergency chains. I always carry a few for that purpose.—GEORGE E. TOMLIN.

3. Inexpensive Flares. Waxed milk containers may be used effectively as flares to warn oncoming traffic when you must make car repairs along a highway at night. Ignited at the top with a match, they burn like torches for five or six minutes. A small stone dropped in the bottom will keep the wind from tipping them.—N. W. GOODWIN.

4. Turner Cleans Off Snow. An ordinary pancake turner carried among your tools will prove a convenience when next you return to your parked car and find the windshield and rear window coated with clinging snow. It may also be used to chip ice off the windshield.—W. E. PRITCHARD.

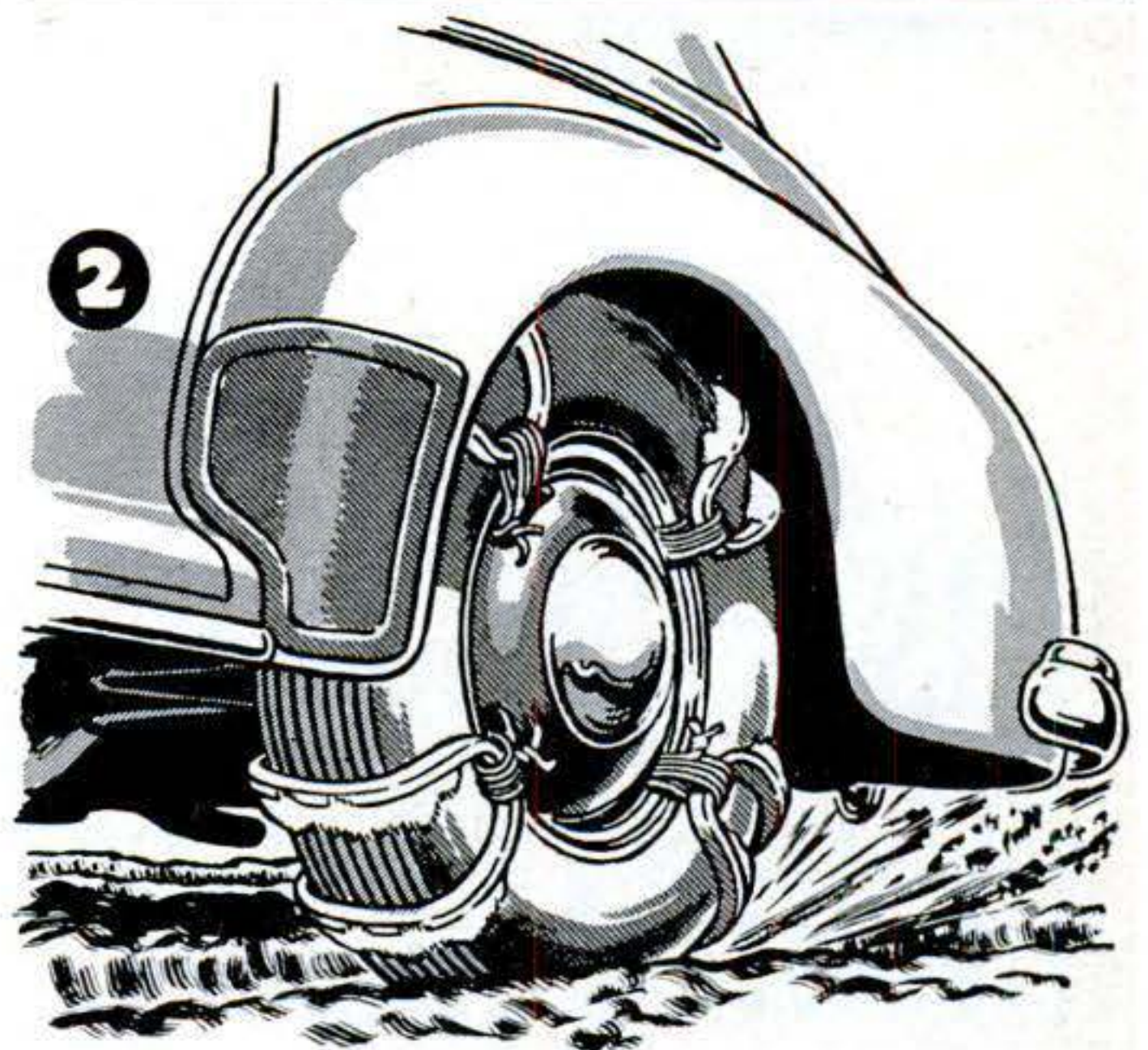
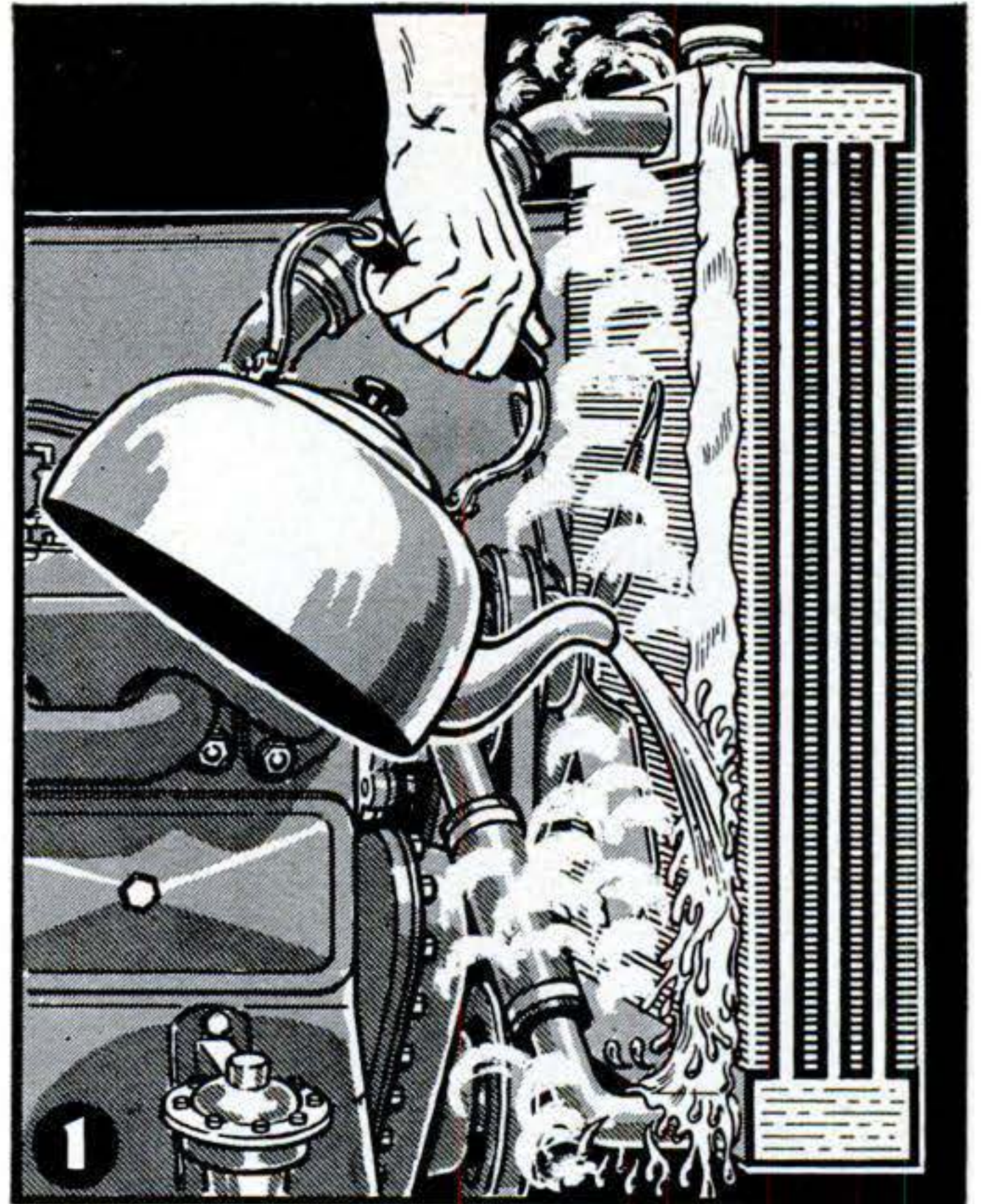

Drawings by STEWART ROUSE

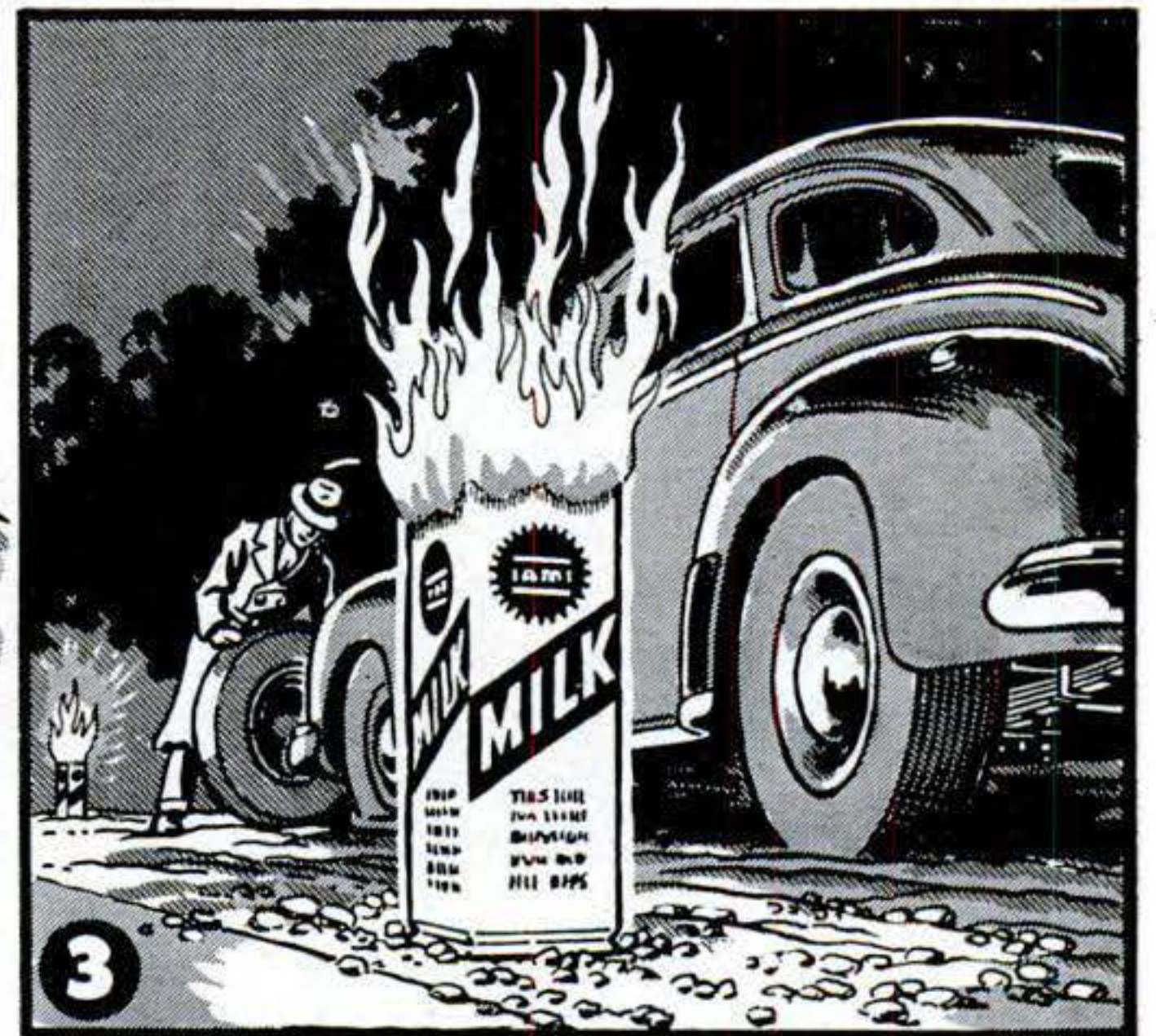
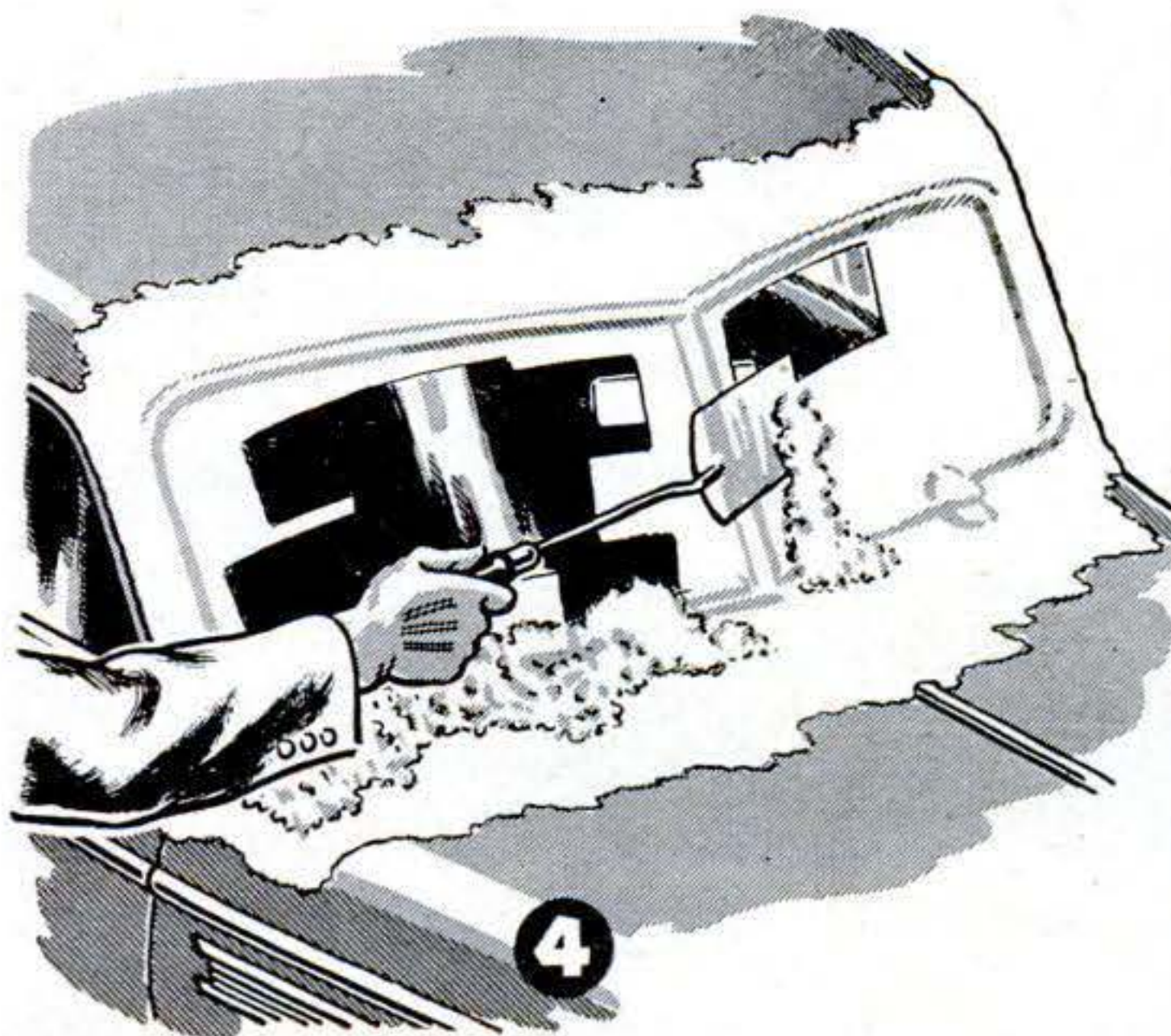

"I spotted a sign saying there was a garage
and repair shop 15 miles further on."

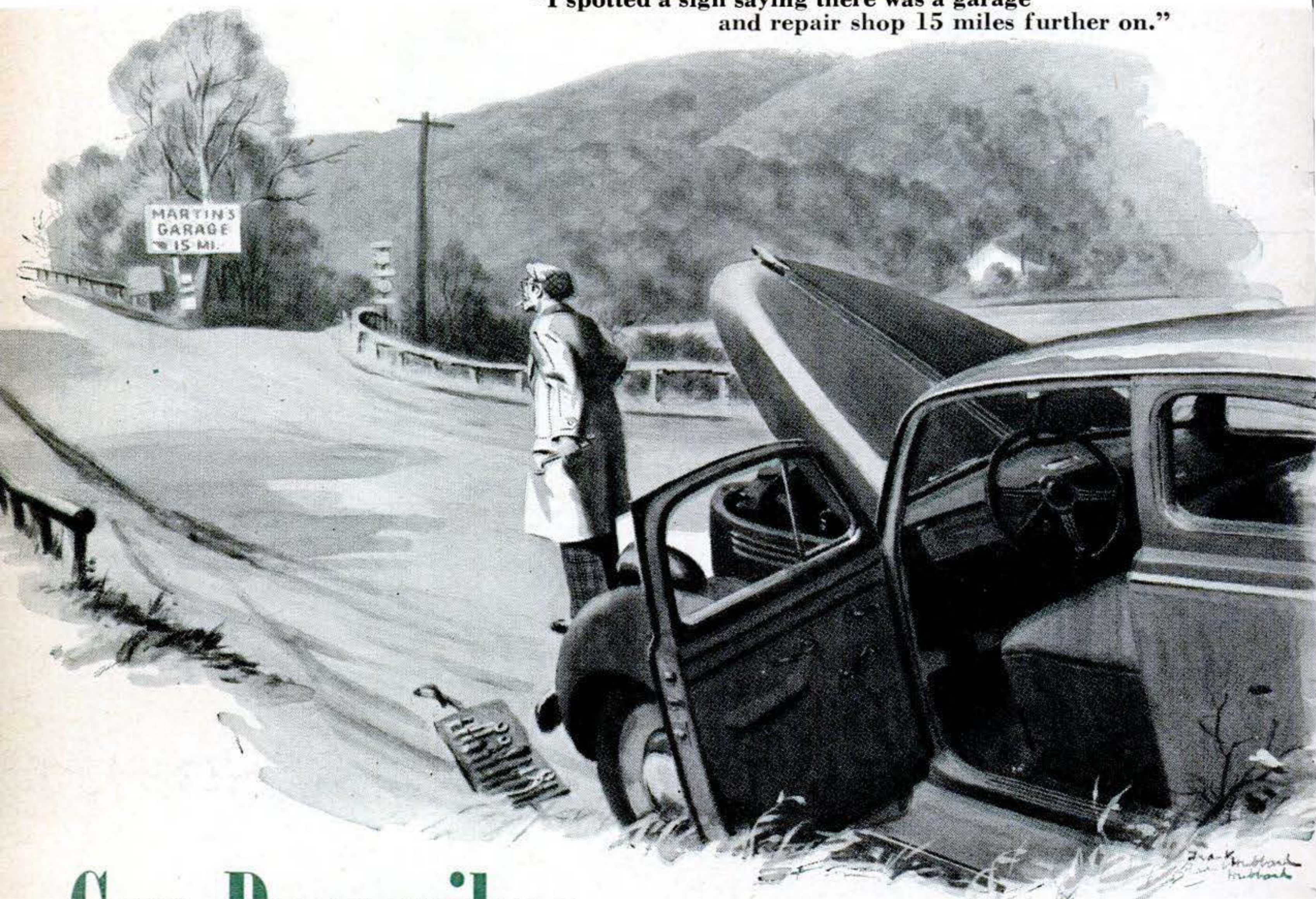

Gus Prescribes an Oil Change

By Martin Bunn

JOE CLARK'S voice over the wire was waspish. "That highbinder charged me twice what the job was worth to put in those new rods—and when he got 'em in the engine wouldn't even turn over. I told him that I wouldn't pay him for work that hadn't done any good, and he said he'd hold the car until I did pay him. Then I told him—"

The thought of Joe Clark on the customer's end of an argument over a repair-job bill made Gus Wilson grin. "Never mind what you told him. What did you *do*?"

Joe's voice went up three notes. "Do?" he yelled. "What could I do? I had to pay him, of course. But I wouldn't let him

touch the car again. A fellow helped me push it out of his shop; now it's standing in the street. The engine won't start, and the next garage is 10 miles away. They'd charge plenty for a tow and probably won't be any better than this nitwit! You or Stan'll have to come with the wrecker and tow me home."

"That's quite an order," Gus hedged. "Where did you say you are?"

Joe named, in highly uncomplimentary terms, a very small town.

"That's well over a hundred miles from here," said his partner after a brief tussle with a road map. "It's almost closing time now, and it'll take most of the night to bring you in . . . Well—O. K. I'll send Stan. By the way, Joe, is there a college handy to that burg you're in?"

"How'd I know?" Joe yelled. "And what difference does it make?"

"I was just thinking that while you're waiting for Stan it would be a good idea to take a quickie course in mechanics!"

The receiver was slammed on its hook

at the other end of the line. Gus grinned. Then he went serious. He was a prey to the vague uneasiness that assails every conscientious mechanic when he hears that a car he has worked on has conked out. "I checked Joe's bus before he started on this trip to Pittsburgh," he thought, "and it was in good shape—considering it's a '39 and has clocked over a hundred thousand miles. Well—we'll see."

STAN and Joe reached home sometime in the course of the night. When Gus got down to the Model Garage next morning he found his partner's car in the shop and its owner, still simmering, waiting for him. "You're a swell advertisement for our business," Gus grinned. "What happened?"

"Nothing happened until I'd got three-quarters of the way home," Joe growled. "I was driving along at about forty with the car running swell—just like it had been running ever since I left here—all of a sudden there was the darndest clatter you ever heard. The sound seemed to come from the crankcase. I figured it was a burned-out connecting-rod bearing that was just about to let go. This happened 'way out in the sticks, but I spotted a sign saying there was a garage and repair shop 15 miles further on. I decided to take a chance that the bearing would hold out until I got there. The clatter didn't let up, but it didn't get much louder, and I made it.

"The fellow who ran the garage could probably find a flat tire if you pointed it out to him, so to save time I said I thought it was a burned-out rod bearing. After he fooled around for 15 minutes he reckoned I was right. I let him go ahead and fix it, and went down the main drag to get something to eat. When I got back he had the crankcase all unbuttoned. He said that all six rods were bad and I'd have to have new ones. Frankly, they didn't look too bad to me, but I was still hoping he knew what it was all about, so I asked what the job would cost. He quoted more than twice what we would have charged for it, and we had an argument. But in the end I told him to go ahead.

"He sent his grease monkey 20 miles to get the rods, and when he finally got started I could see he was strictly a left-handed mechanic. At last—late in the afternoon—he got the rods installed and the engine back together. Everything was fine—except that she wouldn't run! That reformed black-

smith stood there scratching his head. He suggested one thing after another that might be the matter, but I could see he was up a tree. I told him that if he found out what was wrong and fixed it I'd pay him for the job, but I wasn't going to pay for putting in six new rods that weren't needed. We had another argument. He threatened to phone the constable and have my bus held, so in the end I had to come across. By that time I was so sore I wouldn't let him try anything else. I found a fellow to help me roll the car out into the street, and then I called you . . . What do you think can be the matter with the old bus?"

"Soon find out," Gus grunted.

HE RAISED the hood, and went over the engine. While he was doing it Stan came in yawning widely. Gus told him to touch the starter. "No use, boss," Stan protested, but he did as he was told.

The starter ground over with no response from the engine, not even a cough. Deftly Gus checked the fuel and ignition systems; both were operating properly. He thought for a moment and then, on an impulse, removed the valve cover plate and touched the starter solenoid. As the engine was cranked over, Gus was startled to find that the valves remained motionless. Frowning as he worked, he took off the housing on the camshaft timing gear.

"Here's the trouble!" he exclaimed. "Look—five teeth have been stripped off this timing gear. I wonder what caused that? It's made of laminated plastic, so it'd probably give before the steel crankshaft gear, but—hey! The jet that's supposed to spray oil in here is plugged solid!"

He cleared the oil passage with a piece of wire, and rolled what he got out of it between his thumb and forefinger. "Solid sludge," was his verdict. "It stopped lubrication of the gears; heat and friction did the rest. I wonder—"

He got an old drinking glass from his bench, washed it, drained a little oil from the crankcase into it, and held it up to the light. "Your oil is foul with sludge and muck," he said. "No wonder you had trouble—the surprising thing is that you didn't have more of it." He looked hard at his partner. "I told you to fill up with fresh oil before you started. Did you forget to do it?"

"Of course I didn't forget to do it!" Joe snapped. "What do you think I am—a

dope? Why, I even used heavy-duty oil—that new premium stuff we got in just before I left. The oil-company salesman had been telling me how it keeps sludge and such stuff suspended instead of letting it settle in the oil pan, and I figured that using it on my trip would be a swell way to clean out my engine. When I got to Pittsburgh I checked the oil level. The dip stick was as shiny as new—the oil had cleaned all that sticky brown stuff off it, so I knew it was doing the job the salesman said it would.”

Gus stared at his partner. “And you didn’t change the oil?”

Joe looked surprised. “No. Why should I? I’d gone under 1,000 miles and there was plenty in the crankcase. What’s all this about, Gus? Aren’t the new premium oils any good?”

“Sure, they’re good,” Gus assured him. “So is dynamite or TNT or atomic power—if you know how to use ’em. But premium, or heavy-duty, or detergent oil—they all mean pretty much the same thing—can cause a lot of trouble if you don’t use it right. So much trouble in fact that some of the oil companies aren’t recommending it for passenger cars.”

Joe looked horrified. “That’s bad!” he said in a worried voice. “I haven’t sold any of it yet, but I’ve talked it up to several customers. We’ll be behind the eight ball if any of them take my word for it and get in trouble, the way I did.”

“That’s all right,” Gus reassured him. “You can go right ahead recommending it for cleaning out engines, and for all-the-time use by drivers who make long trips at high speed—so long as you make darn sure that the people you sell it to know how to use it.”

JOE pointed to the broken timing gear. “That doesn’t look as if I know how to use it. If it’s that tricky—”

“There’s nothing tricky about it,” Gus interrupted, “if you stop to think that a detergent oil is just what it claims to be—a purging oil. While it lubricates, it cleans off the sludge and other muck—the waste products of combustion—that accumulate on the innards of an automobile engine. Usually there is a dispersant in these oils, a chemical that is added to keep dirt and sludge suspended, instead of allowing them to settle into the oil pan. What you’ve got to remember is that the detergent cleans the accumulated sludge *off* the engine parts

but not *out* of the engine until it is drained off with the oil.

“Your car has been driven over a hundred thousand miles, mostly short runs, without ever having its oil pan down, so its engine must be pretty dirty. I’ve been meaning to clean it up for you, but since we’ve always babied the car and it continued to run well, I never got around to it. You put in detergent oil and then drove from here to Pittsburgh and three-quarters of the way back—say 750 miles. That long run gave the purging oil a good chance to do its job, and it did it. The trouble was that it cleaned so much sludge out of the engine and into the oil that the oil passages couldn’t digest it. They clogged up. The jet that sprays oil between the crankshaft drive gear and the camshaft gear was plugged solid with hard, high-temperature sludge. If the resulting breaking of the timing gear hadn’t laid you out on the road, you probably would have burned out a bearing—the bearing lubricating tubes are nearly filled up.”

“And still,” Joe growled, “you say there’s nothing tricky about detergent oil!”

“There isn’t,” Gus said. “Not if you change it before the sludge it has cleaned off the engine parts has a chance to do any damage. For an engine that’s just average dirty, the oil should be drained, and the crankcase flushed, after about 300 miles, and again after another 500 miles. But for an engine that’s really dirty, the first change should be made after only about 100 miles. You can’t do any harm by changing the oil too soon—but you can do a lot of harm by not changing it soon enough.”

“You’ve got something there,” Joe admitted. “Now if you can get my bus rolling, maybe I’ll take a little drive.”

“What for?” Gus asked apprehensively. “You aren’t figuring on trying to collect the dough you spent for the con-rod job?”

“Naw.” The co-owner of the model garage smiled sheepishly. “We got a college right here in town, and I’m thinking it’s about time I took that quickie course in mechanics you’ve been talking about.” **END**



Mechanics and Handicraft



Clock Plays Music PAGE 166

Child's Wardrobe PAGE 170

Glass-Topped Iron Tables PAGE 186

How to Silverplate Wood PAGE 210

Chemistry Spins a Yarn PAGE 214

Basket Chair and Taboret Covered with Cowhide

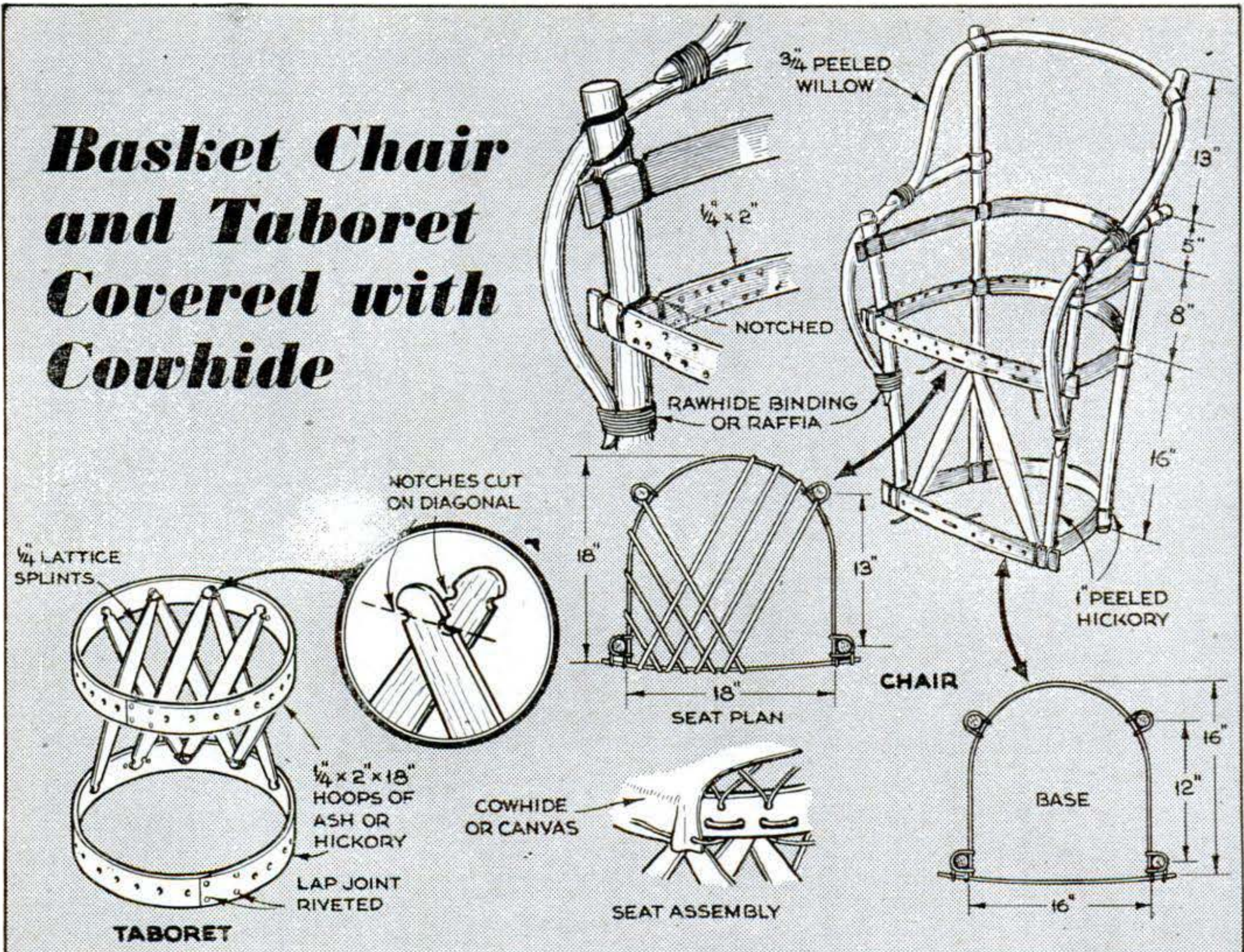

MEXICAN craftsmen introduced this patio furniture to the Southwest. Working with primitive tools and materials, they have managed to fashion such comfortable and eye-appealing pieces that the supply of imported chairs and taborets like those illustrated has fallen hopelessly behind the

demand. If you have a spot in your porch or garden that calls for this rustic furniture, you'll find that the quickest way to fill the vacancy is to build it yourself.

The drawing shows a simplified adaptation of the original; it can be made with jackknife, saw, and hand drill. Willow withes or other flexible branches that may be picked up in the woods are ideal for the frame. Hickory or ash should be used for the seat and base hoops, and $\frac{1}{4}$ " lattice splints for the diagonals that join them. Rawhide or raffia, and cowhide or canvas, in any combination, serve for the lacing and seat and back.

Soak or steam the ash or hickory and bend it around a rough form to make the three semicircular hoops needed for the chair. Bind them to the four legs with rawhide or raffia set in casein glue or shellac. The curved top frame and arms are installed next, and the diagonal slats are bound inside the hoops as shown. Rawhide strips are crisscrossed over the seat to support the cowhide or canvas cover, which is then fitted and laced in place. Seat and back are cut separately, and each piece is laced tightly in its frame.—HI SIBLEY.



Date-palm fronds are used in this Mexican original, but $\frac{1}{4}$ " splints may be easier to obtain.

Swinging Doors Close Off Kitchen

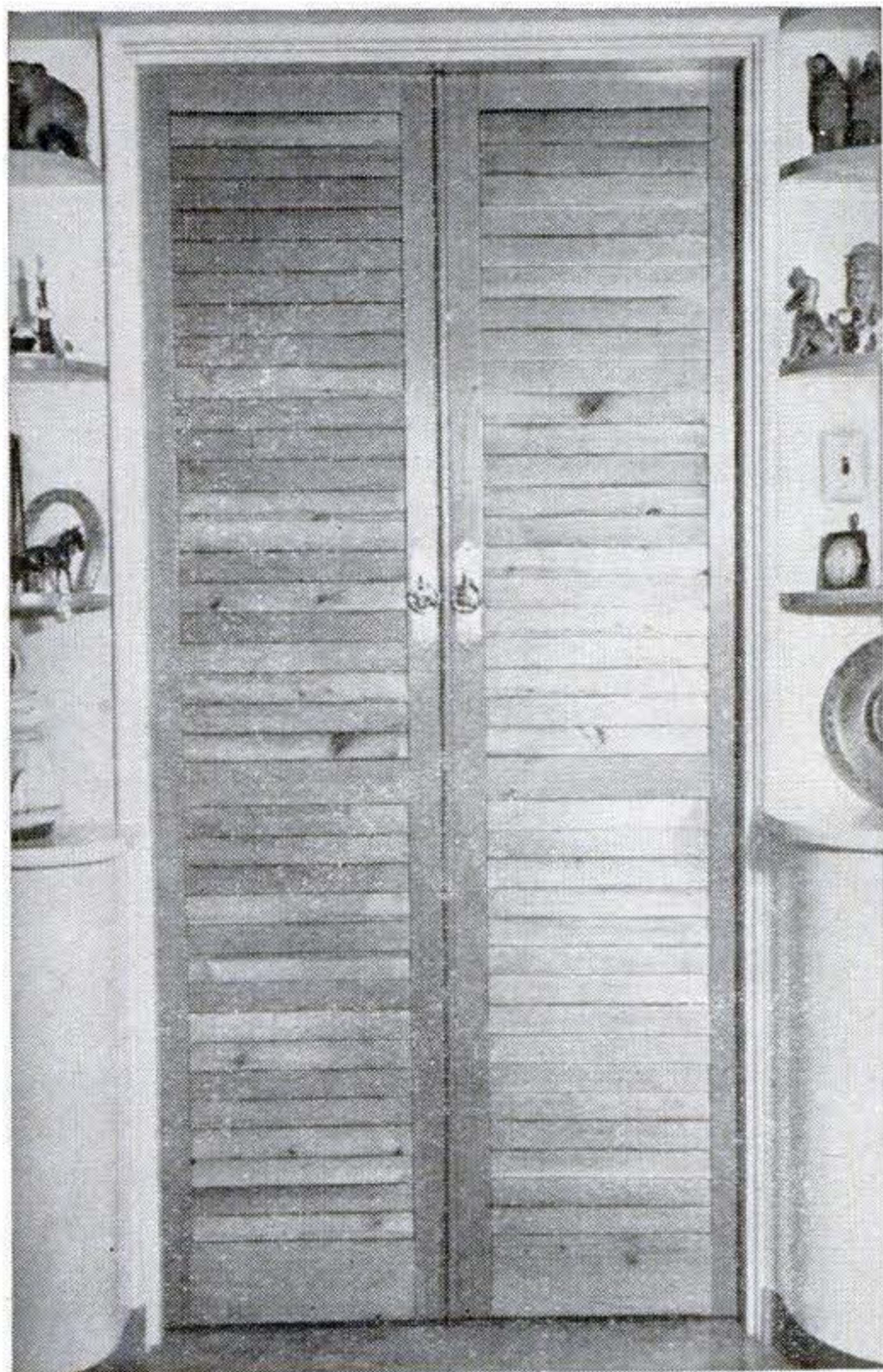

Fit the doors with brass hardware. Hang them to swing either one or both ways as desired.

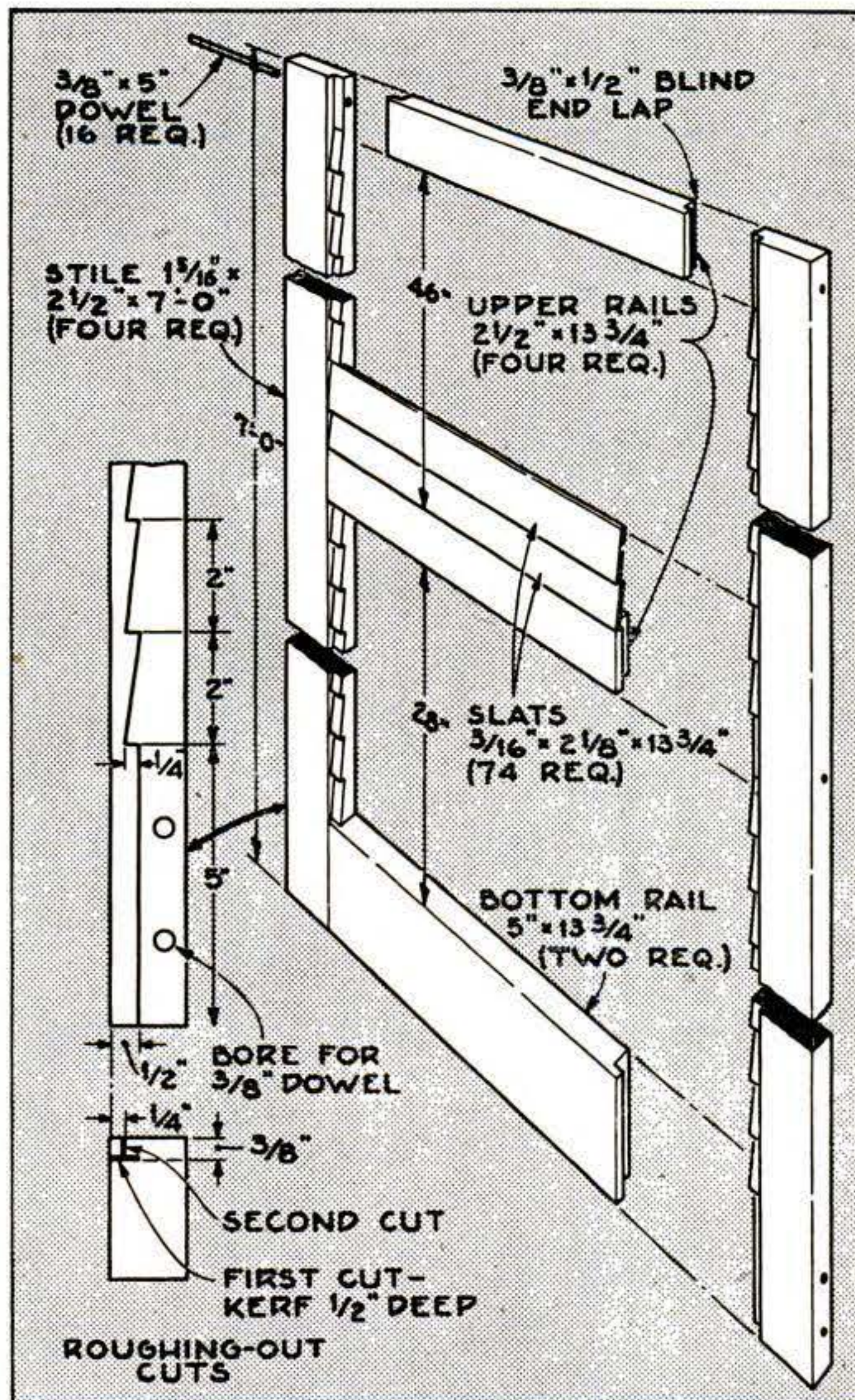

BESIDES being a convenience, swinging doors of the ship's-cabin type bring a note of distinction to a doorway between the kitchen and dining room. The dimensions and requirements given in the above drawing are for two doors to suit a 3' by 7' doorway.

Stiles and rails may be made from 1½" door stock (it measures 1 5/16" net), cut to size, and joined by blind end laps pinned with 3/8" by 5" dowels.

Notches may be cut in the stiles for the slats by first making a saw kerf ½" deep 3/8" from the edge and then sawing away a ¼" section of this cut. At the points where the three rails join the stile, chisel out to the bottom of the first saw cut. Then mark off the notches 1 7/8" apart to allow the slats to overlap slightly, and chisel out the notches. Alternatively, notches might be made by cutting wedges and gluing them into a rabbet.—EDWARD R. LUCAS.

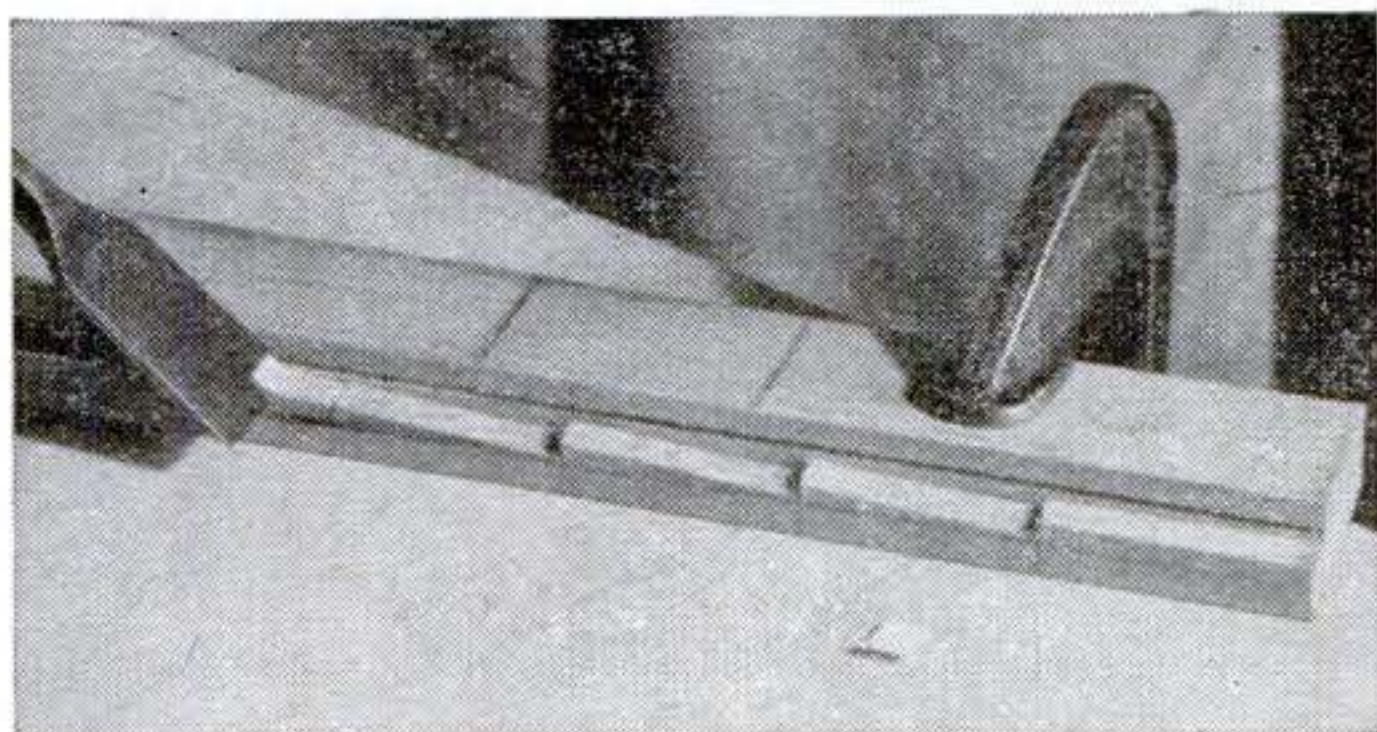

Chisel out each notch after cutting kerfs as shown in the drawing. Space them 1 7/8" apart.

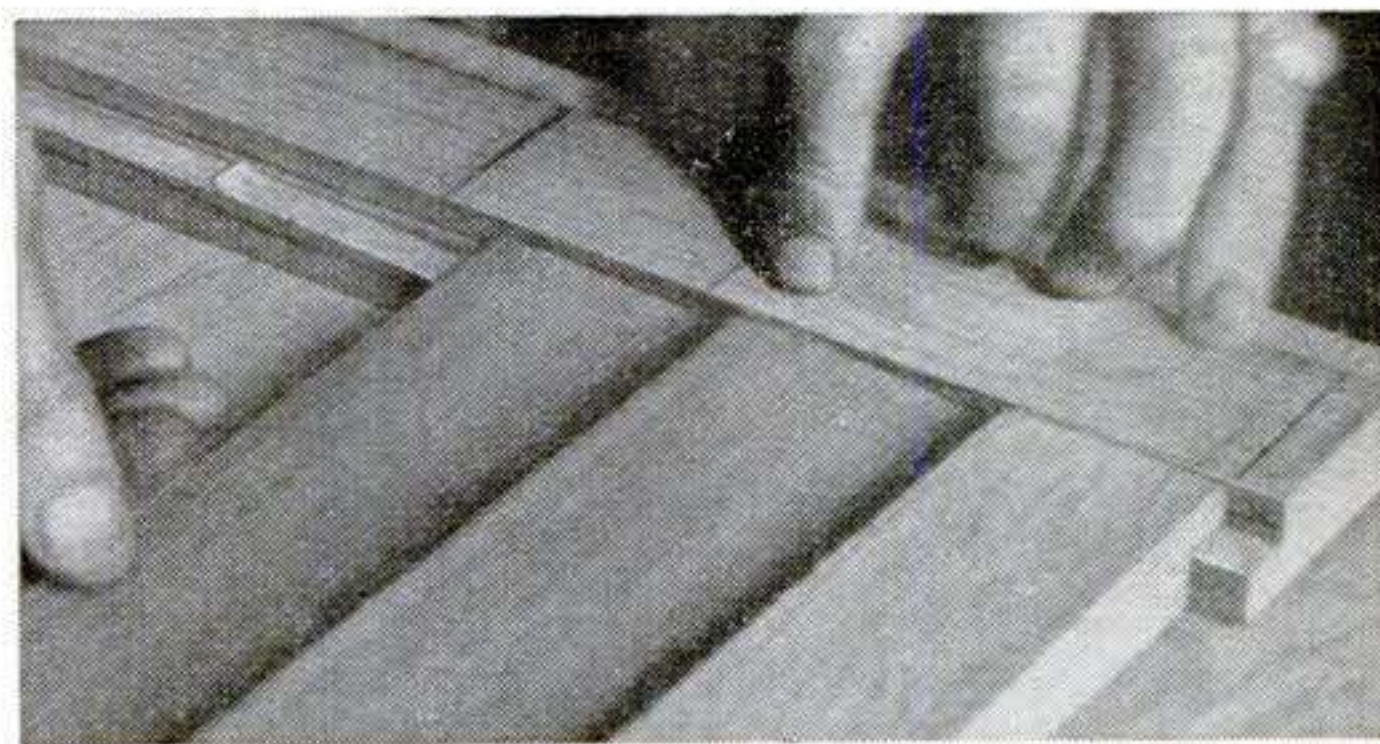

Overlap the slats slightly and glue them in position. Also glue all the joints of the frame.



Electric Clock Plays Music on the Hour

By **R. J. De Cristoforo**

IF YOU are looking for a project worthy of becoming a real heirloom piece, here's one with absolutely no strikes against it—an electric clock housed in a handsome case along with a Swiss music-box movement that plays music on the hour, every hour. A toggle switch mounted on the back and wired into the circuit makes it possible to shut off the music during the night if you wish.

Selection of the music movement deserves a lot of care. The unit shown has a large drum and plays two tunes to each revolution. In any event, since you will be hearing it so often, make certain you choose one that especially appeals to you and your family. Perhaps a movement can be salvaged; if not, one can be bought from a mail-order supply house.

Before starting the project, it is advisable to study the drawings and photographs thoroughly to get a clear picture of the action and construction. You will note that a pin on the clock minute-hand gear triggers the action. Revolving once an hour, this pin momentarily presses together two electrical contacts—just long enough for the music-mechanism motor to turn the music drum until two other spring contacts are pressing firmly against a brass disk on one end of the drum. This completes the main circuit, and the drum then makes a full revolution, stopping only when one of the latter contacts drops into a notch in the brass disk and breaks the circuit. When the next hour rolls around, the pin again closes the first pair of contacts and the cycle repeats.

Selection of the electric clock itself is an important feature, since it may have a face

Housed in a walnut case, the clock marks each hour with a tinkling tune from a music box.

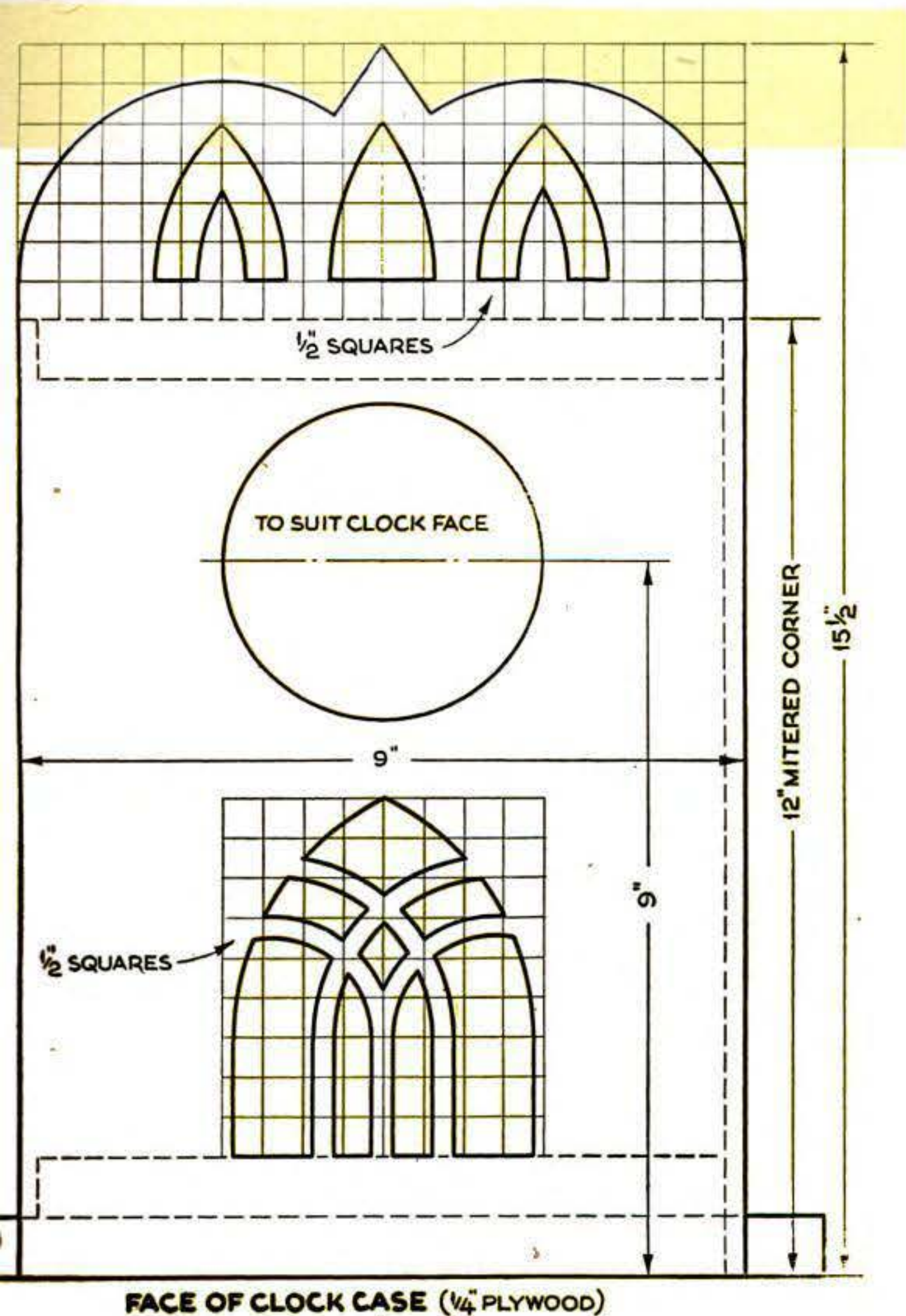

of a size or shape that will necessitate altering the case. For this reason, it probably will be best to leave the case until last, and start by assembling the music mechanism on the sliding bottom shown in the photo and drawing at right.

Availability undoubtedly will determine your selection of a motor to run the music movement. In browsing through various stores, I found a dozen or so different motors that appeared suitable for the job. When tested, however, several lacked sufficient torque to turn the movement. I finally came across a capacitor type with a built-in gear box that turns at 2 r.p.m.—just the speed required.

Wiring for this motor is shown, but if any ordinary motor having only two power leads is used, connect it at A and B in the drawing. If you should use a larger or smaller music unit, check the speed of the drum while turning under the original spring power and then buy or gear down a motor to turn the movement at this speed.

A capacitor was included in this circuit to make sure the induction motor would start immediately, but it is optional. A slight delay in starting should not make any serious difference.

Take the music movement apart and discard everything except the drum and reed comb. The drum may be mounted as indicated in the drawing, or you may prefer to hacksaw the original casting and utilize its parts as I did. Mount the brass contact disk with two small screws after drilling and tapping suitable holes in the drum. The size of the notch in the disk is best determined after you have noted how much the motor overruns when the current is cut. Locate the notch directly opposite a blank space on the drum so the music will stop at the end of a tune—not in the middle.

A gear also may be screwed to the drum, or if you prefer it could be soldered in place. To simplify the job, the large gear was attached directly against the original one in my clock. Before operating the mechanism, be careful to see that the motor turns the drum in the right direction, for turning it in reverse might ruin the reeds.

After the motor, gears, and music assembly are in place on the mounting board, set up the two spring contacts and apply the current while one is in the circuit-breaking notch. Then push this spring with your finger to complete the circuit and allow the drum to make a complete revolution. If the

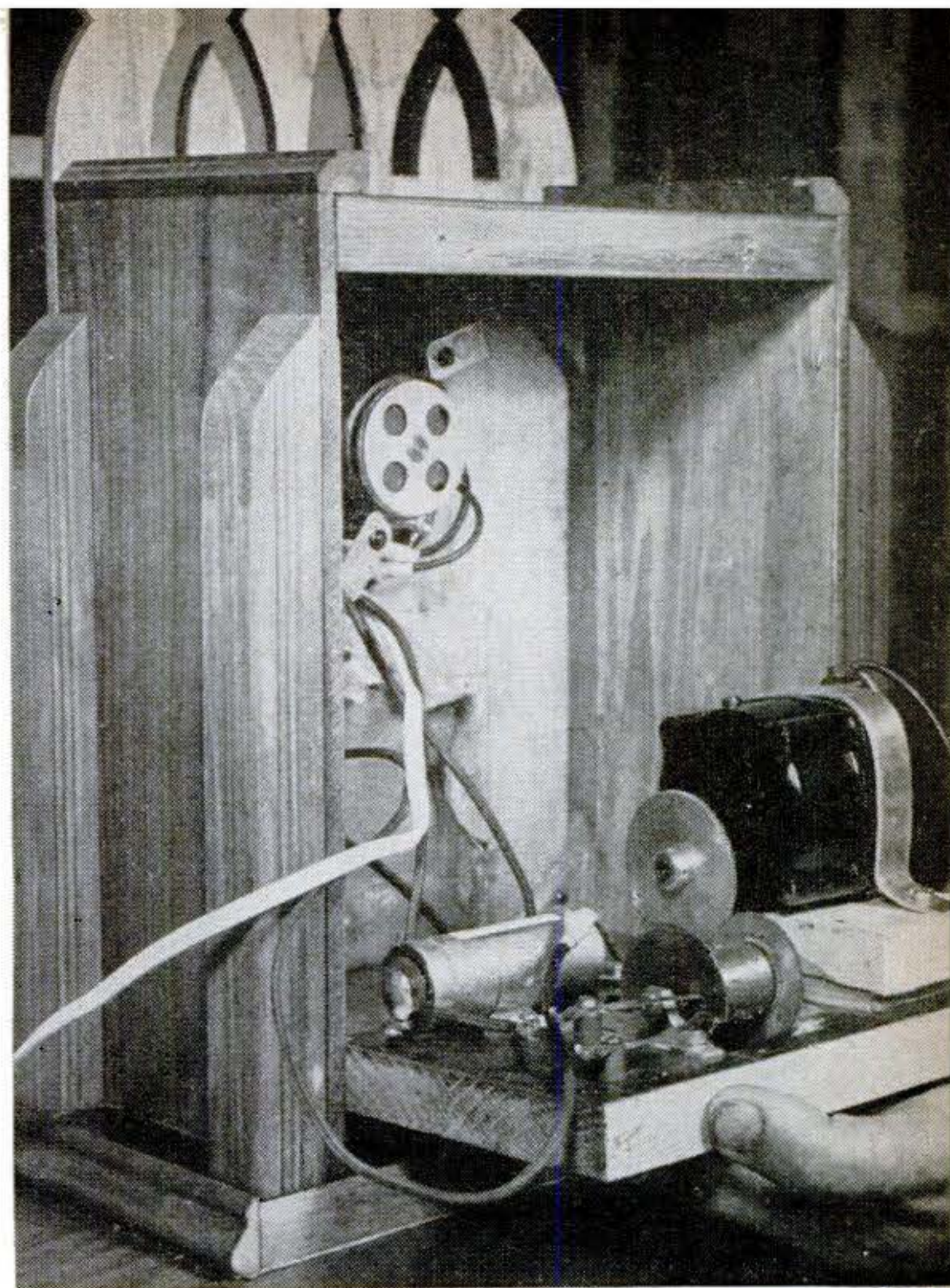

An electric motor drives the music drum. Both are mounted on a board that is slid into place.

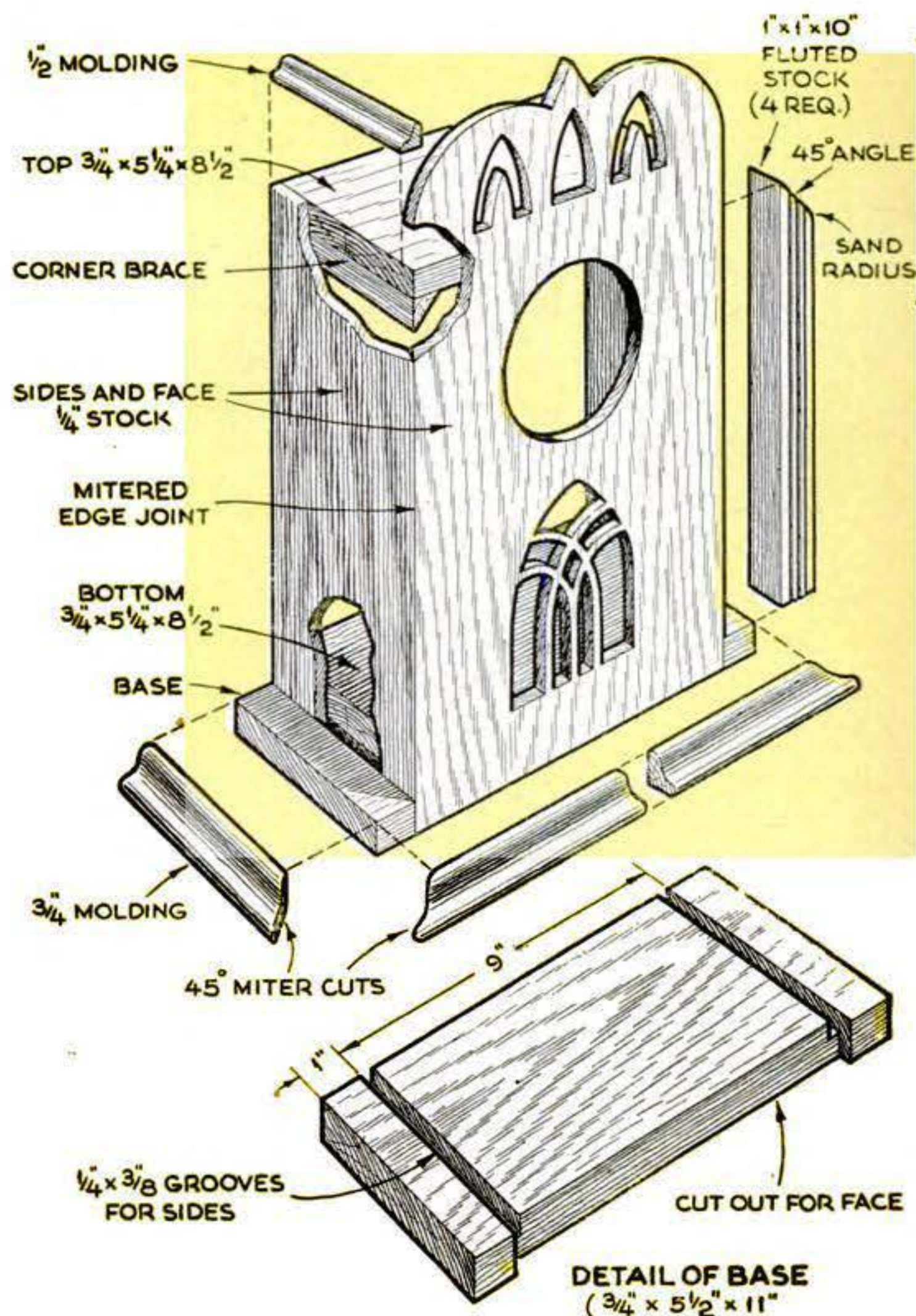

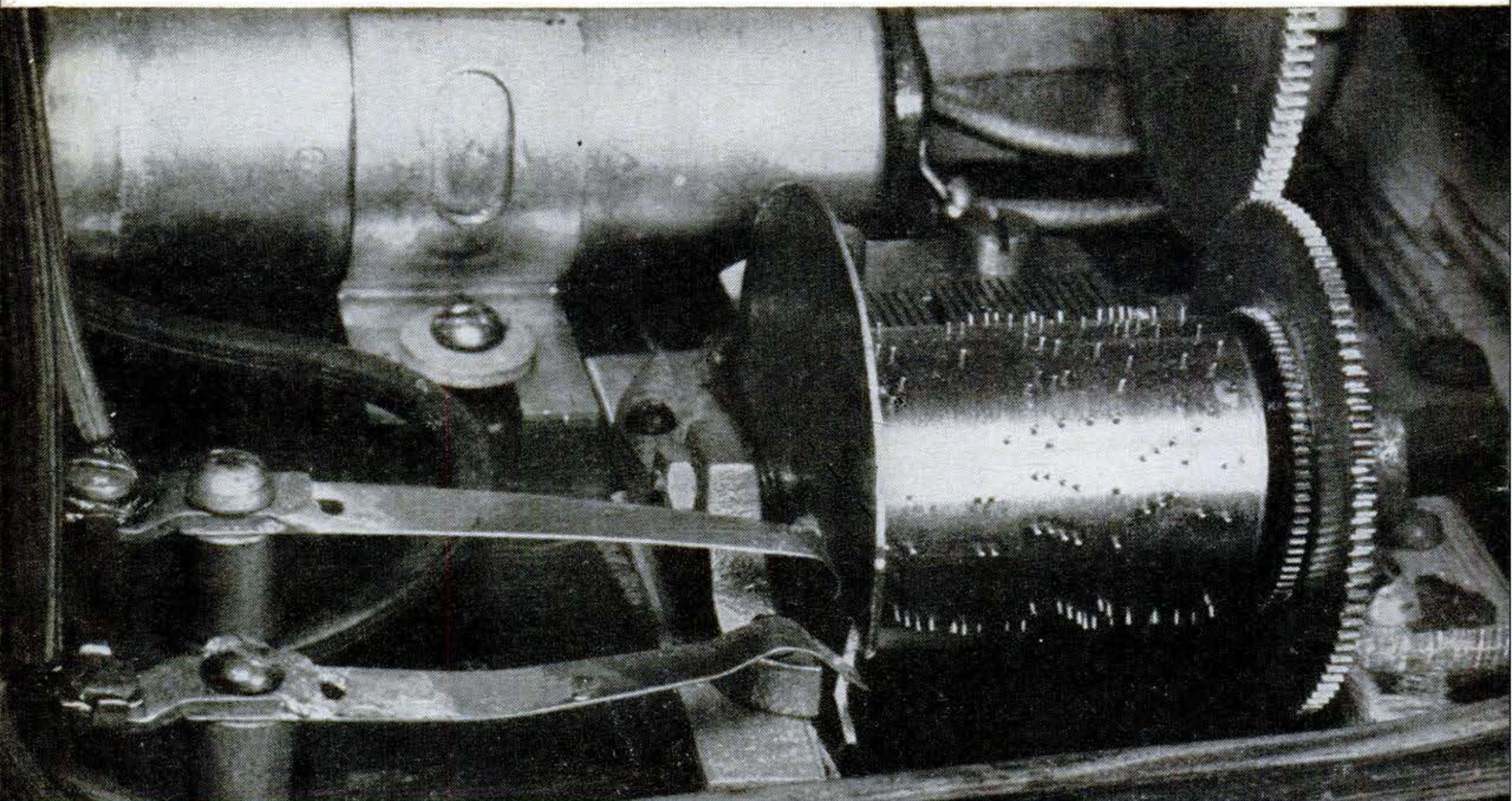

Two spring contacts ride against a brass disk on one end of the drum while it revolves. The

circuit is broken when one drops into a notch in the disk. This stops the drum and the music.

motor overruns enough to allow the spring to jump the notch, lengthen the latter slightly with a file so that it will not.

When this part of the project is operating successfully, make the two upper contacts and mount them on a piece of wood. Then include them in the circuit and again apply the current to check the action.

It is now time to think about the clock to be used. An inexpensive kitchen model will do the job if you can find one with a face that pleases you.

When you have located the minute-hand gear, the one that makes one revolution an hour, attach the trigger pin to it, being careful to see that the pin does not interfere in any way with the rest of the clock movement. In the clock that I used, this gear is readily accessible, but in some it may not be. This is a point to bear in mind when selecting the clock.

Another is the fact that in the ordinary electric kitchen clock the gears do not turn when the hands are operated manually to set the timepiece. Because of this, you will face the problem of synchronizing the clock and music movement so you will get your tunes on the hour—and not somewhere between. Such clocks can be adjusted so that moving the hands will move the gears, but this is a job that will vary with each indi-

vidual clock. Rather than go to this trouble, it is suggested that when the clock and music mechanisms are complete you follow this procedure:

Apply the current until the music starts to play, but cut it off immediately. Then set the hands of the clock to the next exact hour. When another timepiece shows that this hour has rolled around, apply current and let the clock go.

Since it is necessary to synchronize the mechanisms in this manner only when you first set them going, the setting procedure is not enough of a drawback to discourage you from using an inexpensive clock. Of course, if you have a clock in which the gears turn as the hands are set you can forget about this operation.

Straight-grained walnut with an oil finish will give the clock case a handsome appearance. After jigsawing the face of the case to the pattern in the drawing, cement a piece of tapestry cloth over the back of the lower scrollwork, and attach the clock with bent metal straps. Install two runners on the inside of the case bottom to support the music-mechanism mounting board when you slide it in or out. To soften the music tone, cement a piece of felt to the base of the mounting board. A back may be either screwed or hinged to the case. **END**

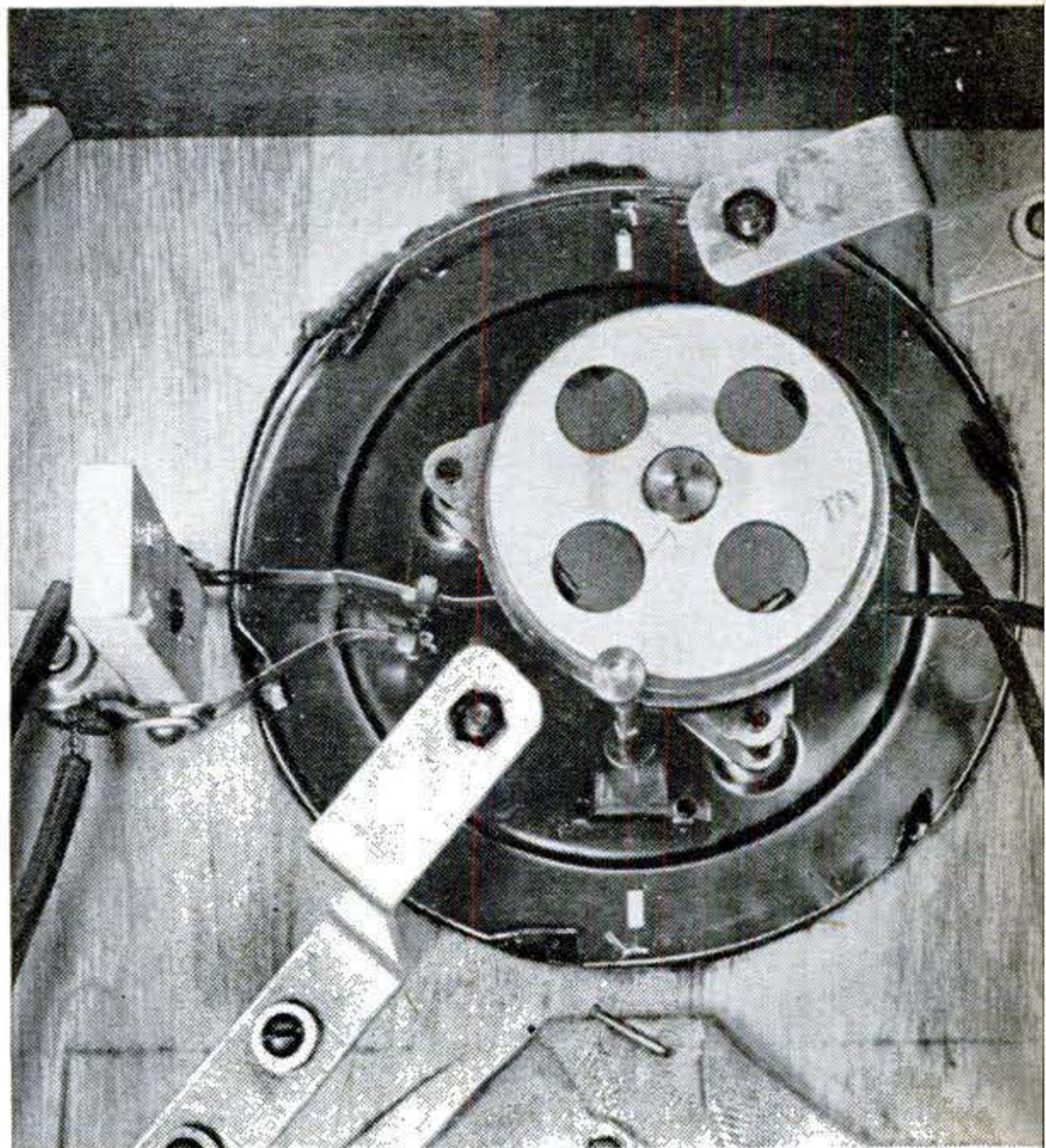
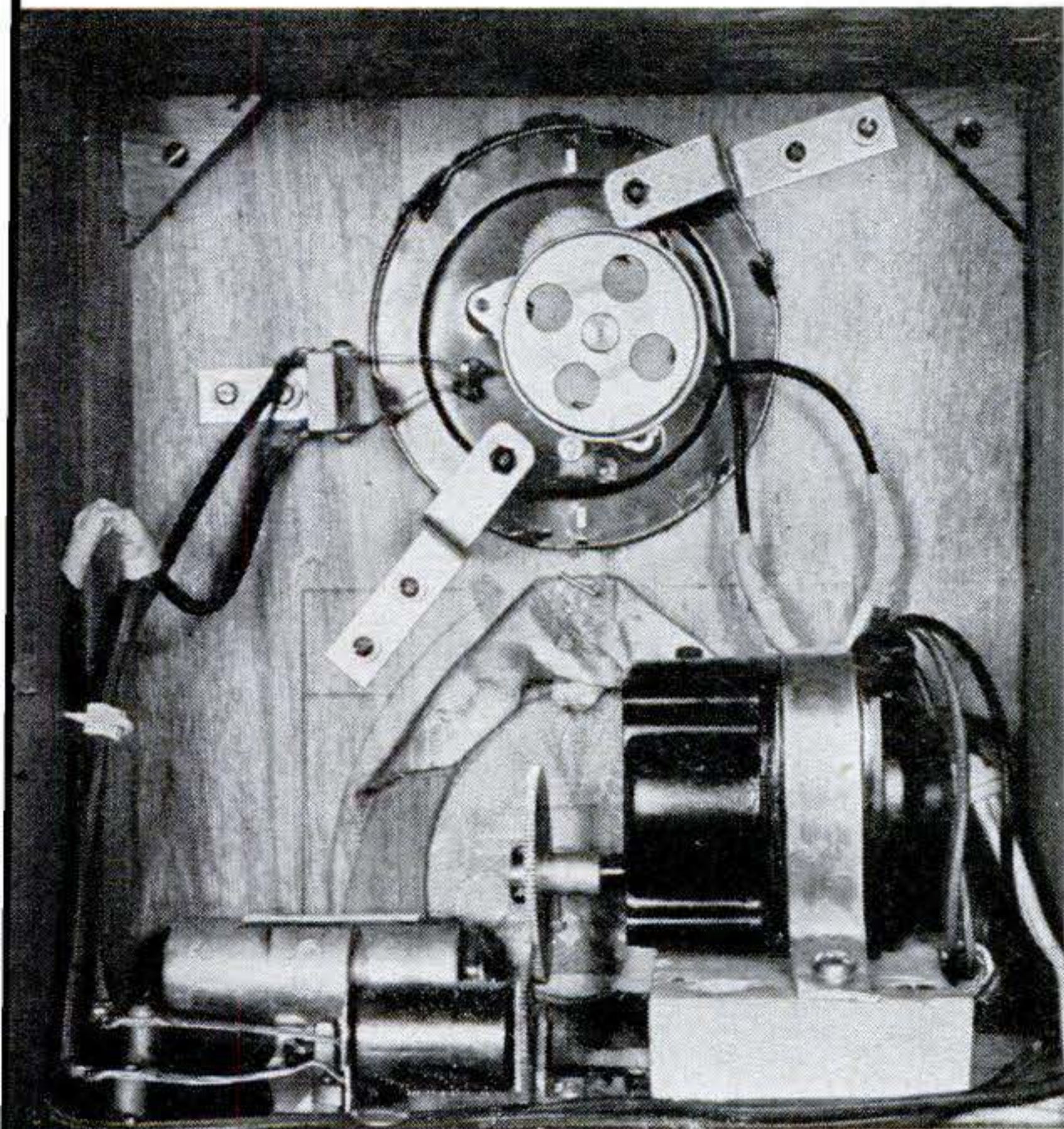

Revolving once an hour, the minute-hand gear has a pin that forces two electrical contacts to-

gether just long enough to start the music drum, which then makes one complete revolution.

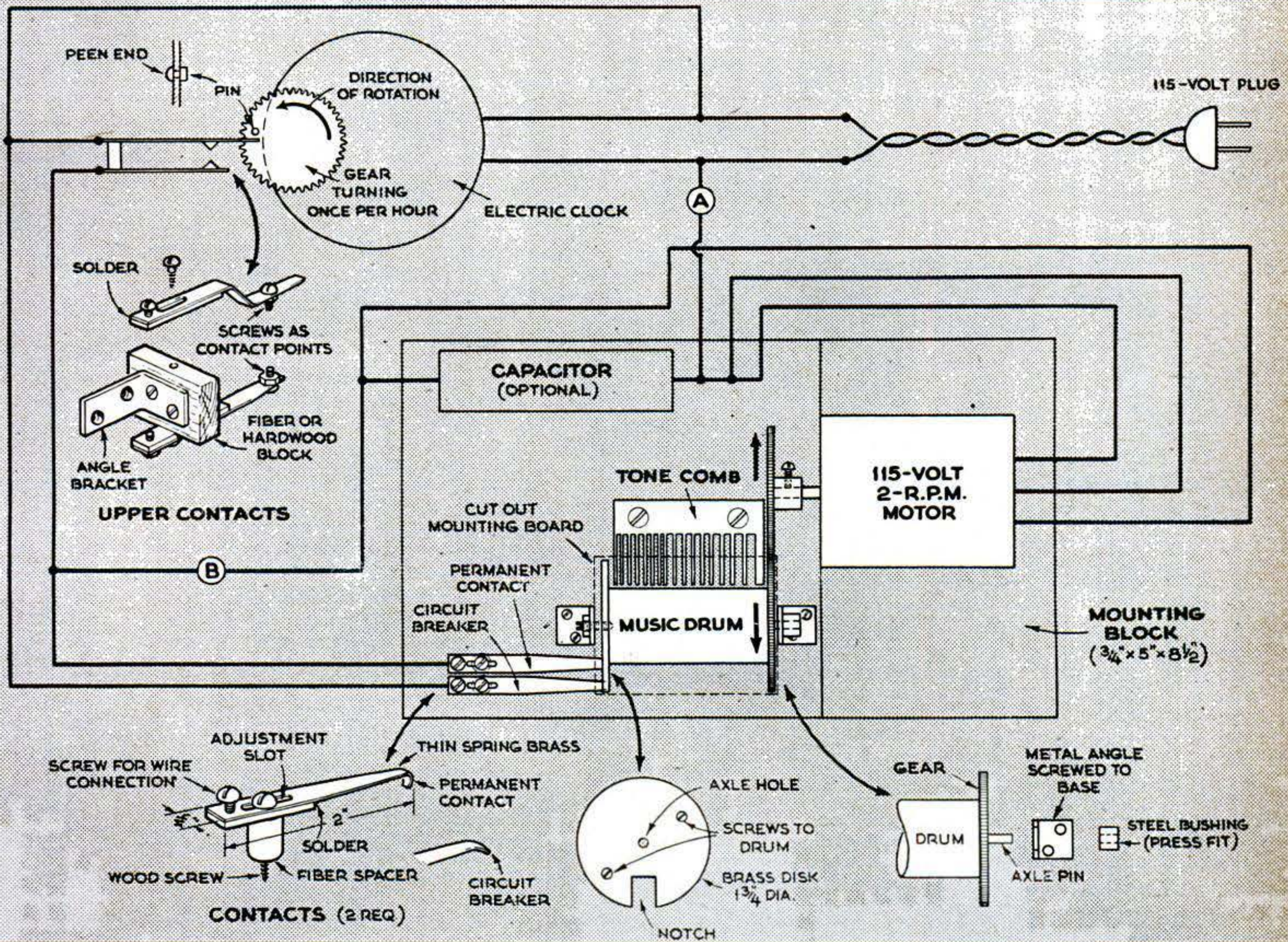

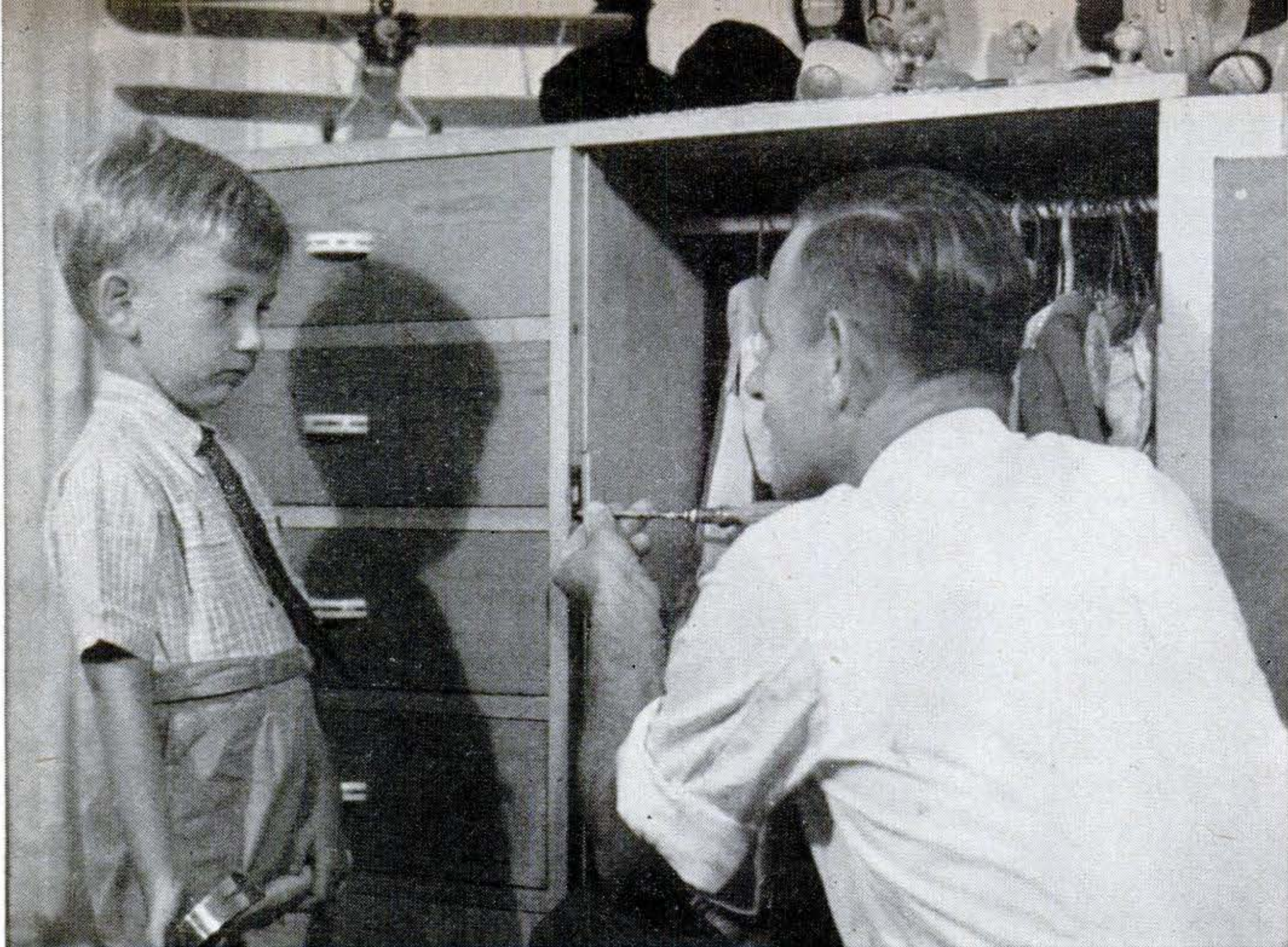

Tired of squeezing your youngster's duds into your closet? Build him a wardrobe of his own.

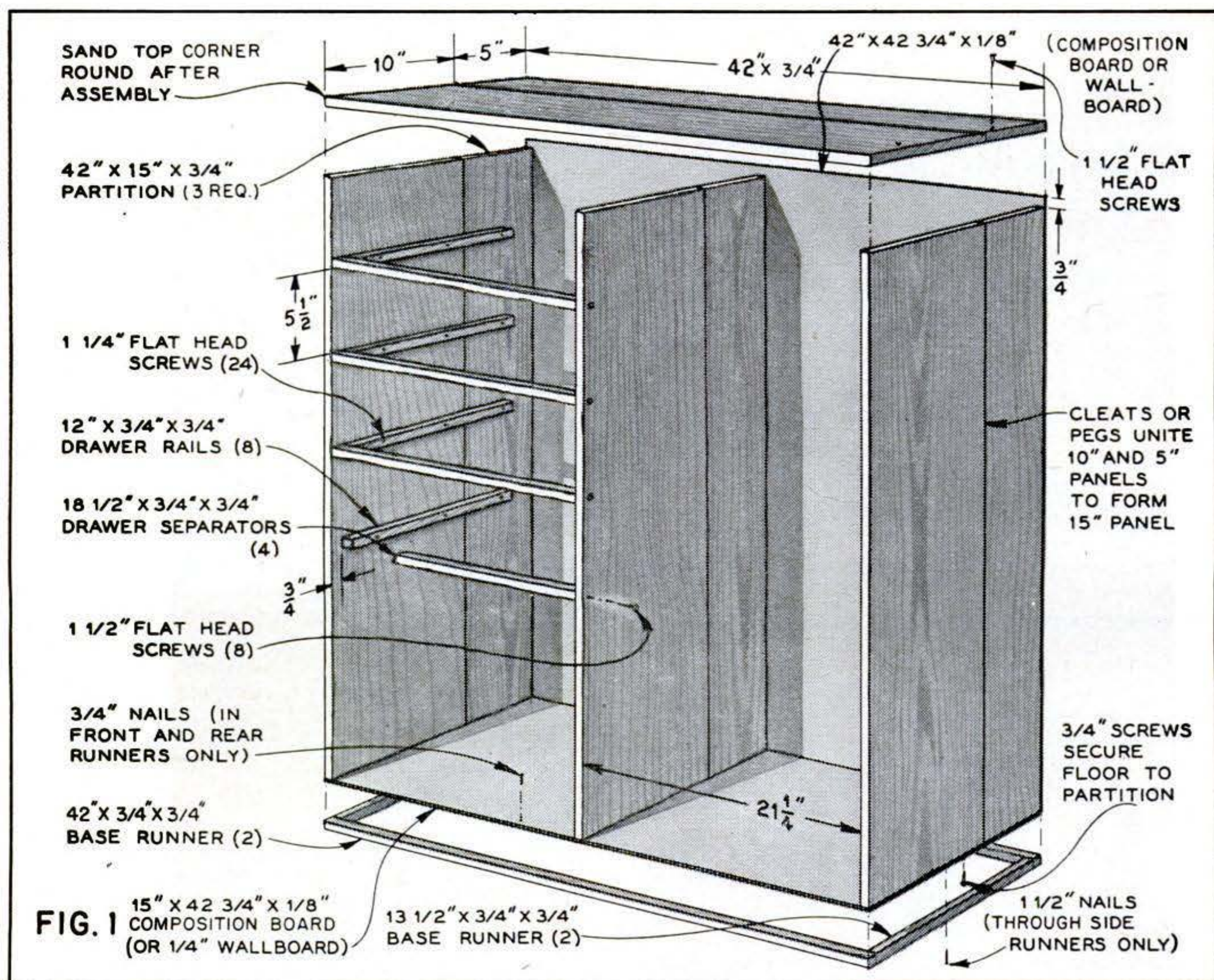

Child's Wardrobe Is a Hammer and Saw Job

By Henry Clark

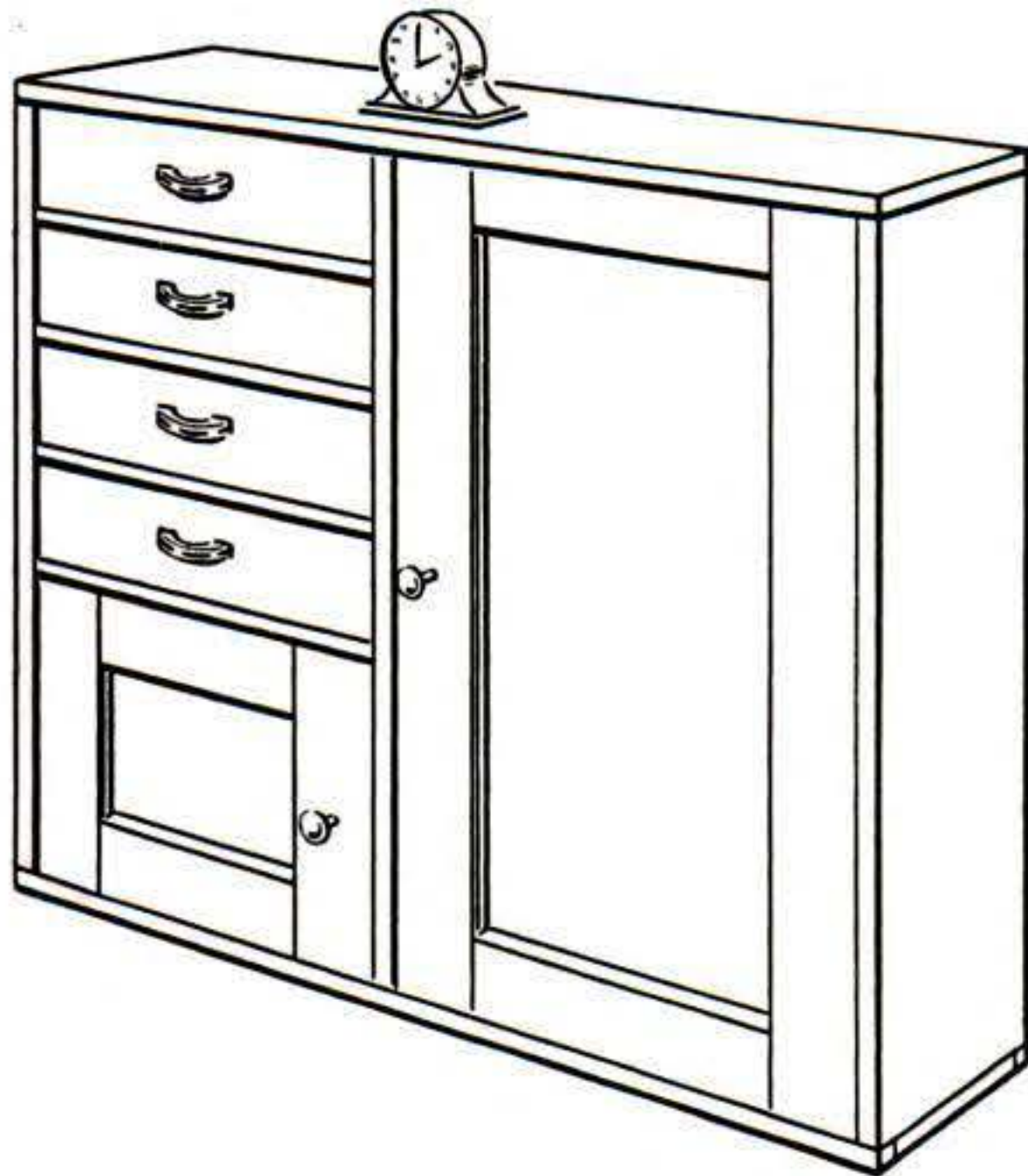

IF YOU'VE gotten past the stage of wondering how you are going to buy all the clothes your growing youngster needs, you have probably started wondering where you are going to put them. That's the time to dig out the hammer and saw and get to work on this handsome, modern child's wardrobe or closet.

The basic structure is shown on the facing page. Three walls are cut from $\frac{3}{4}$ " by 15" stock—if wood of that width is available—or built up from 10" and 5" widths. To these a top is added, and joints are butted and screw fastened. Back and bottom are made of wallboard or composition board; cut them to size and screw them in place.

Base runners are put on next. Drawer rails consisting of $\frac{3}{4}$ " square strips are then added in the left compartment. Separators are

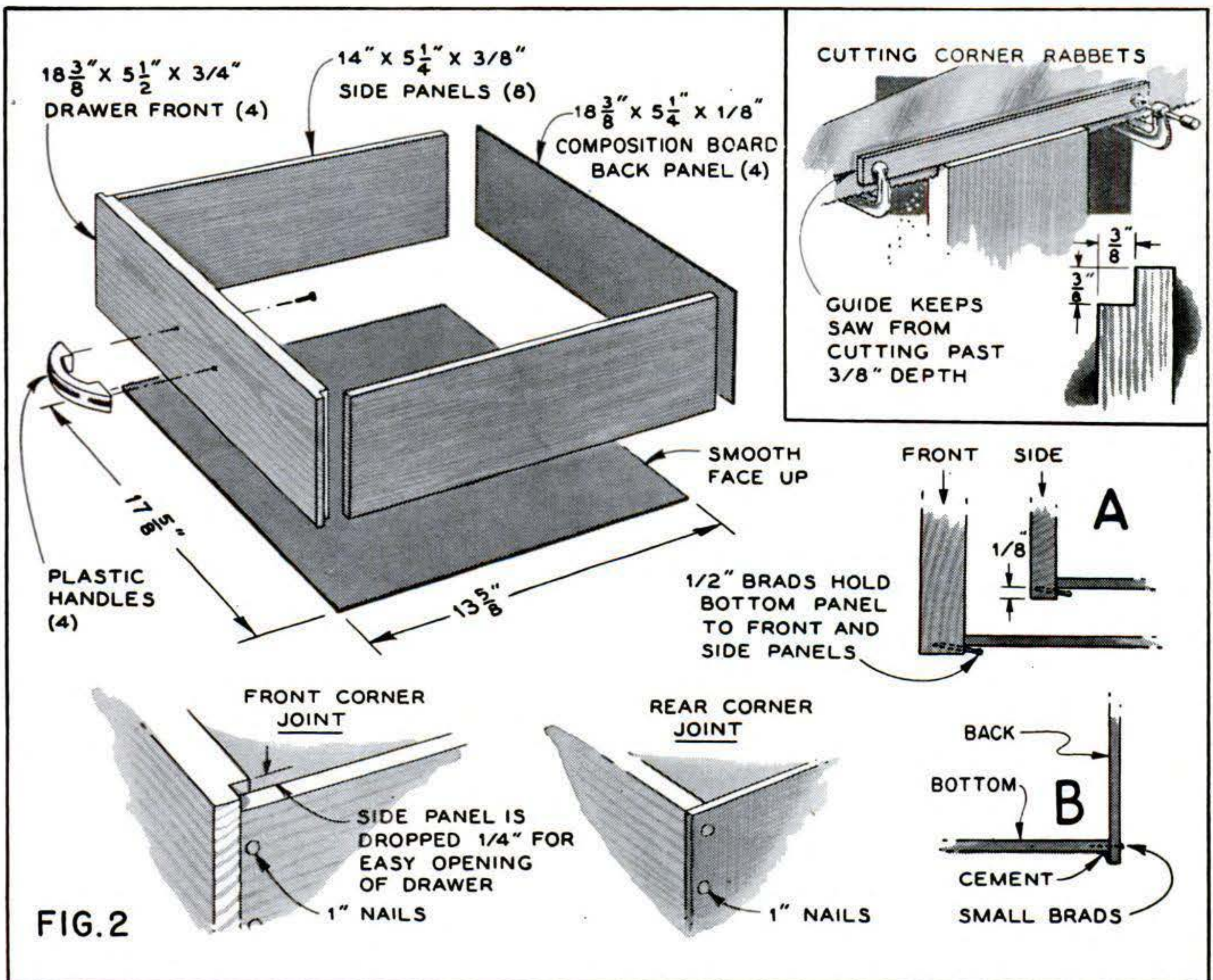

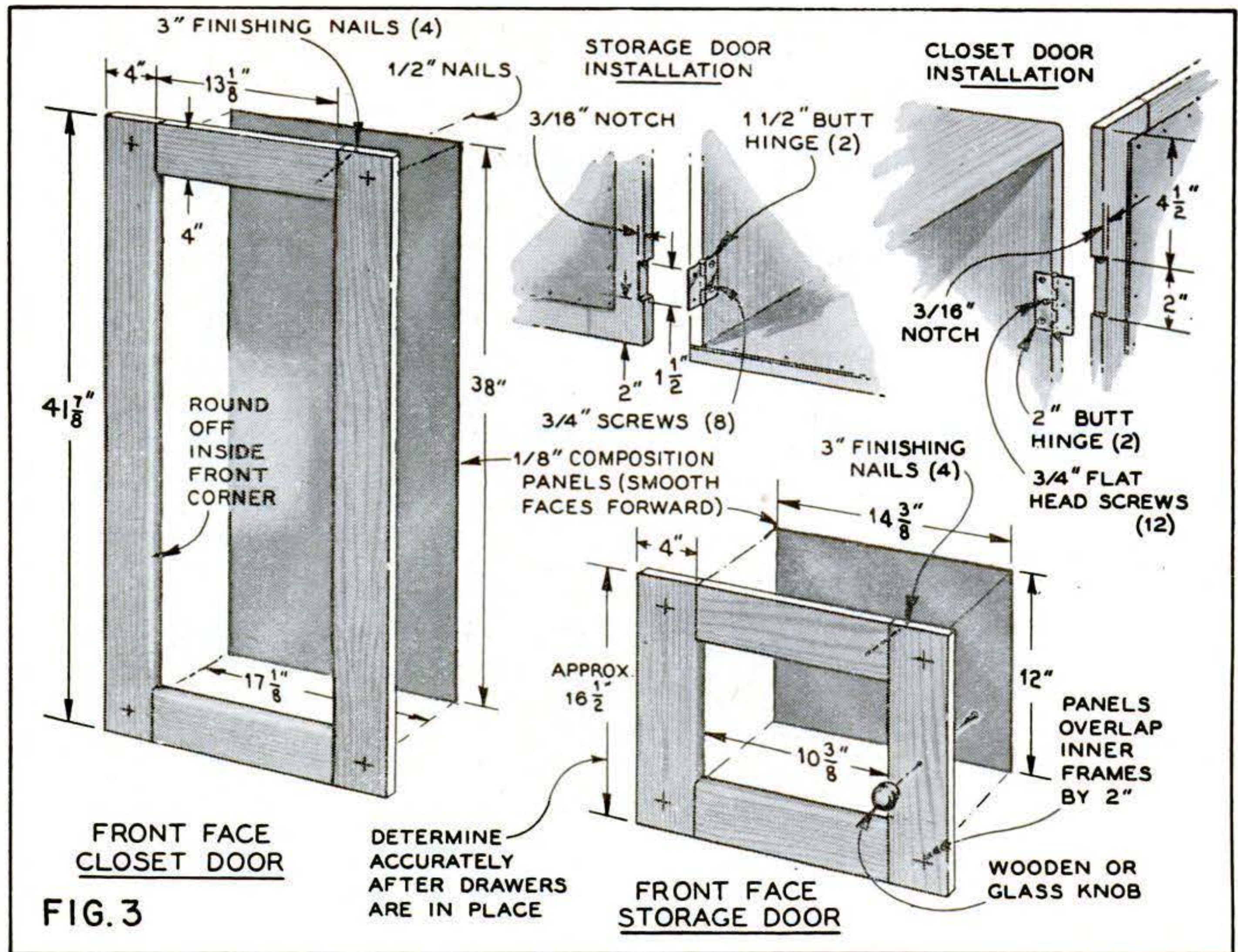

butted in front of the rails and secured with countersunk flathead screws driven through the left side and center partition as in Fig. 1.

Cut the drawer faces to size—in one operation if possible—and rabbet them as shown in Fig. 2. Eight sidepieces, all exactly alike, are sawed out and squared. Backs and bot-

toms are made of composition board, and drawers are assembled with glue and small nails. If front, back, and sides of each drawer are properly squared, the bottom should fit snugly into the open box. Plastic handles are attached, and the drawers are put in place. Planing and filing will correct for sticking or jamming.

You can now determine the exact height of the storage door. Cut and assemble this and the closet door as shown in Fig. 3. Butt hinges are added after their positions are determined and notches are chiseled out.

It is important to get the hinges and doors properly aligned for correct closing. A small doorknob and latch are installed as in Fig. 4, and stops are nailed in to keep the doors from swinging past the shut position. Add a friction catch to the small door, a clothes pole and utility shelf as illustrated, and the construction work is completed—unless you'd care to install a mirror in the recessed closet-door panel.

To finish the piece, round the corners of the top and sand all surfaces smooth. A coat of stain or enamel dresses up the wardrobe—and you have a piece that will serve your child for years to come.

END

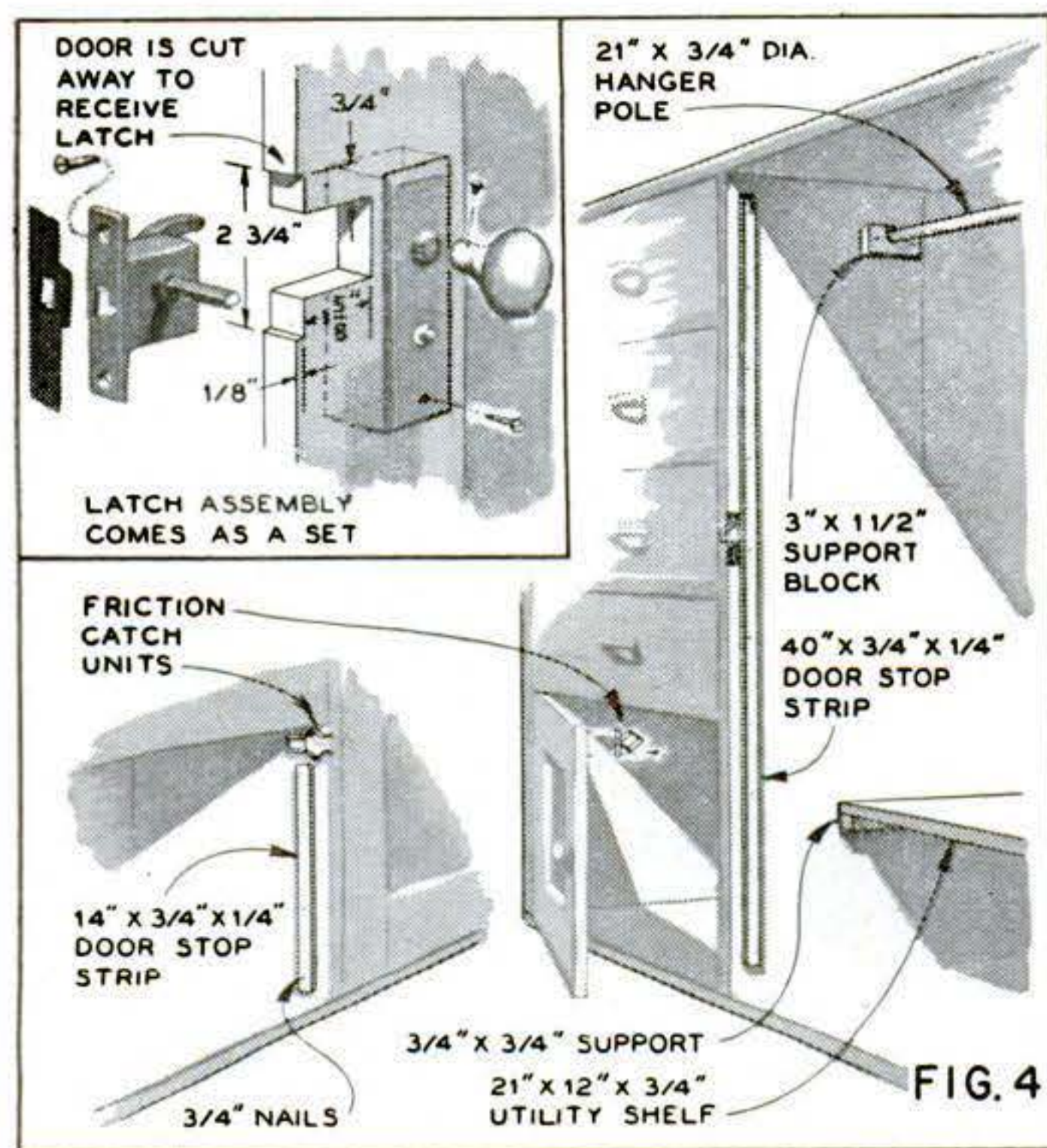

Kiddy Car in Tractor Style

KICKED along like a kiddie car, this little tractor will give a child many happy hours. As maneuverable as a tricycle, it runs easily because of the large wheels.

Build up the body from pieces cut approximately to the sizes in the photo below. Assemble rigidly with glue and countersunk flathead wood screws. If tricycle wheels are not available, wheels turned from maple may be fitted with rubber tires and axle bushings.

Form the rear axle from 1" channel iron, bending it to a U-shape so as to provide adequate room for the child's heels on their rearward thrust. Use sufficient length to space the wheels 16" apart. Bolt the axle fast in a notch cut in the top of the long frame member about 3½" from the rear. Over this attach a seat cut from ½" stock. Round all metal corners with a file.

Although a tricycle fork was used in this case, a fork may be assembled as seen in the drawing. Steering is provided by a single ¼" rod, directly coupled to lugs on the fork and on an 11" steering shaft cut from ½" rod. You probably can find a suitable steering wheel on another toy.

Paint the body red and the wheels some contrasting color.—WILBER H. FULKER.

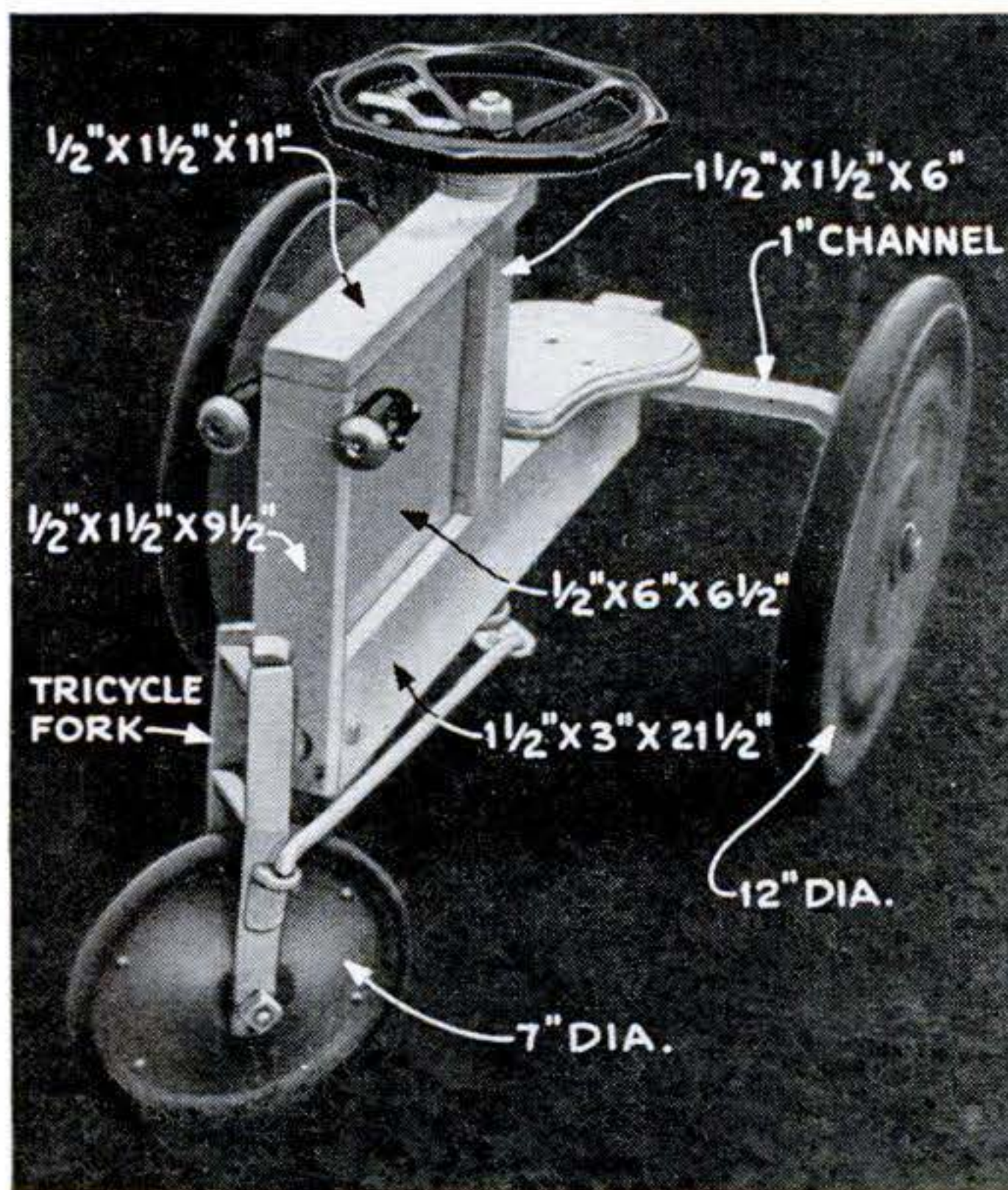
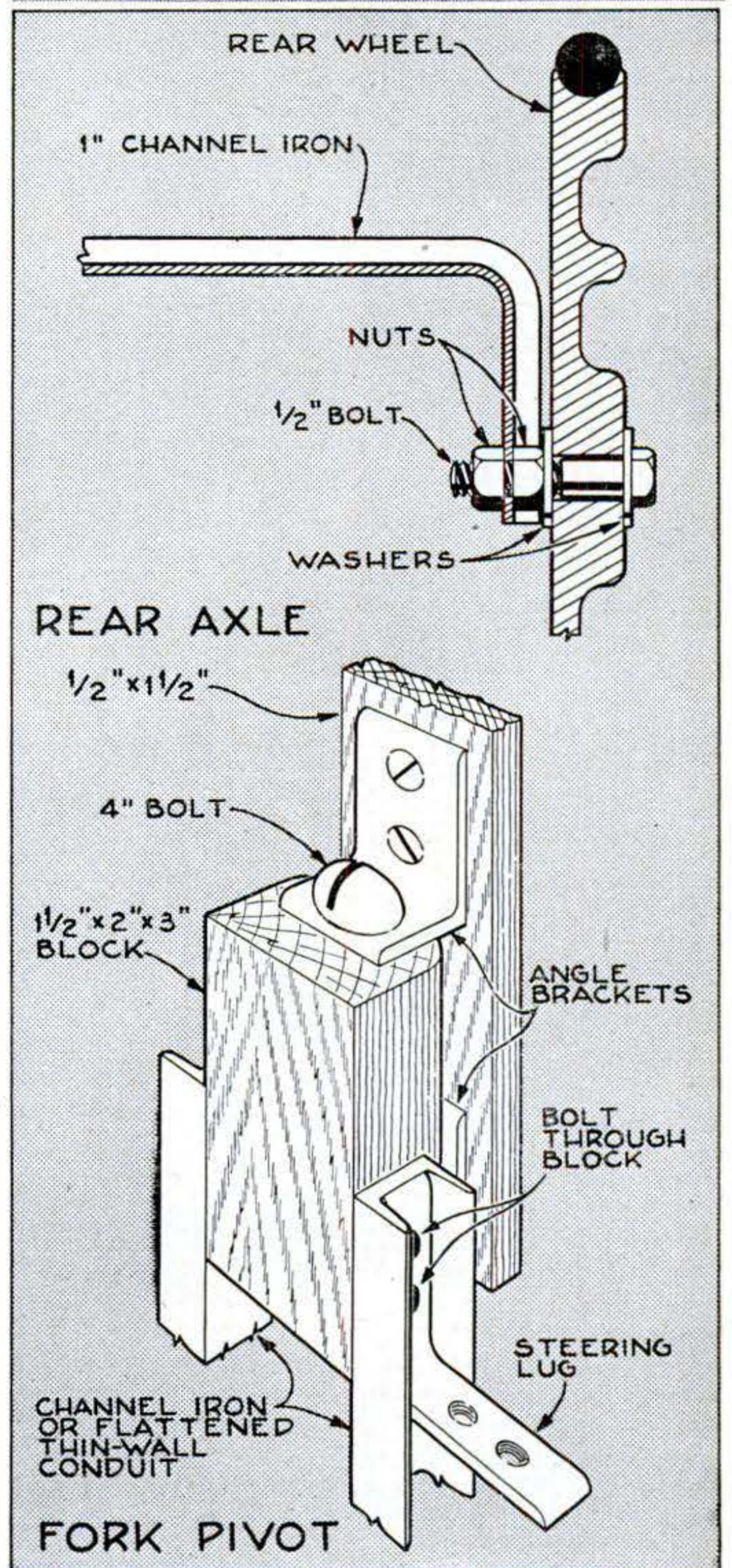
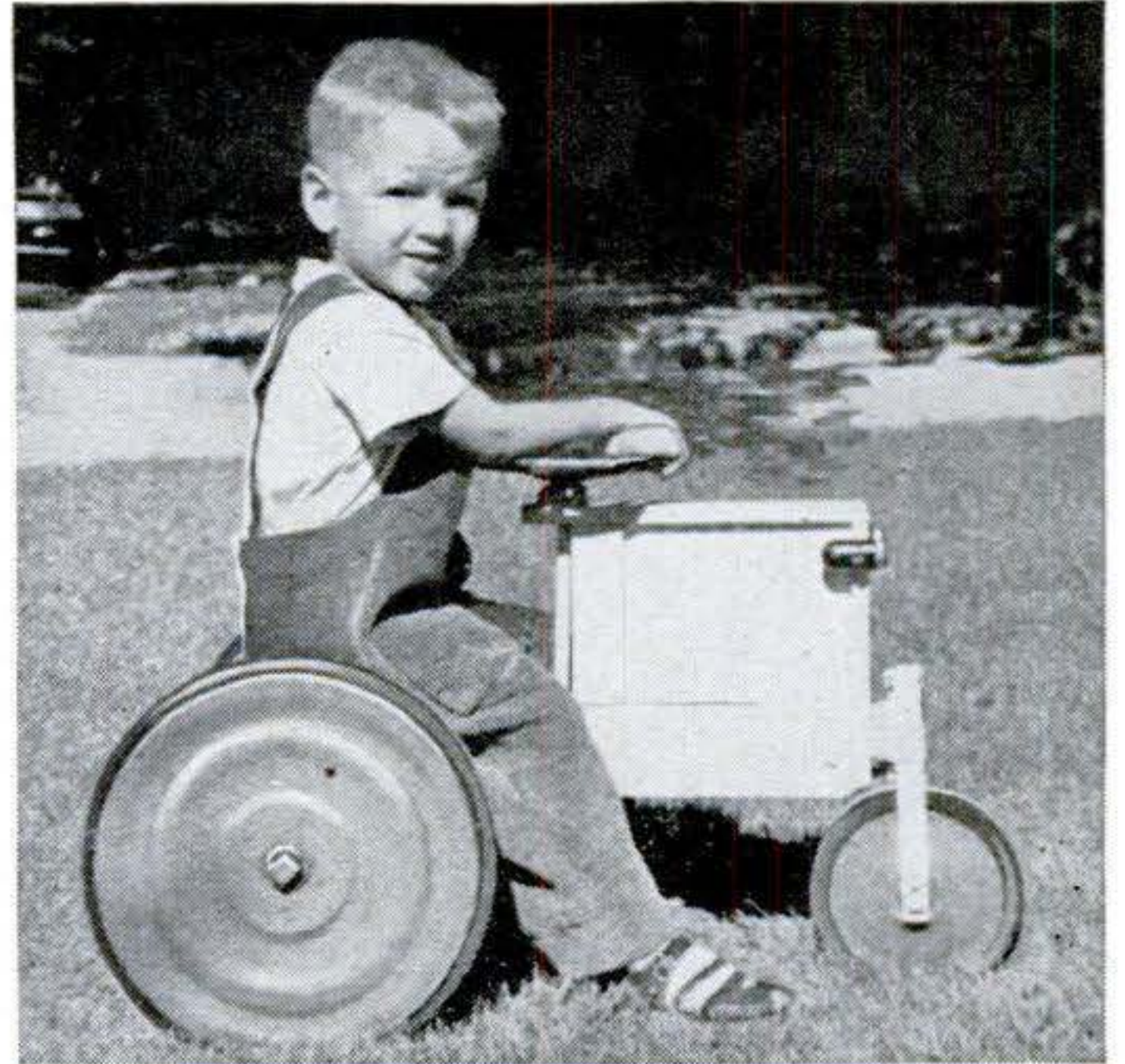



KEEPING THE HOME SHIPSHAPE

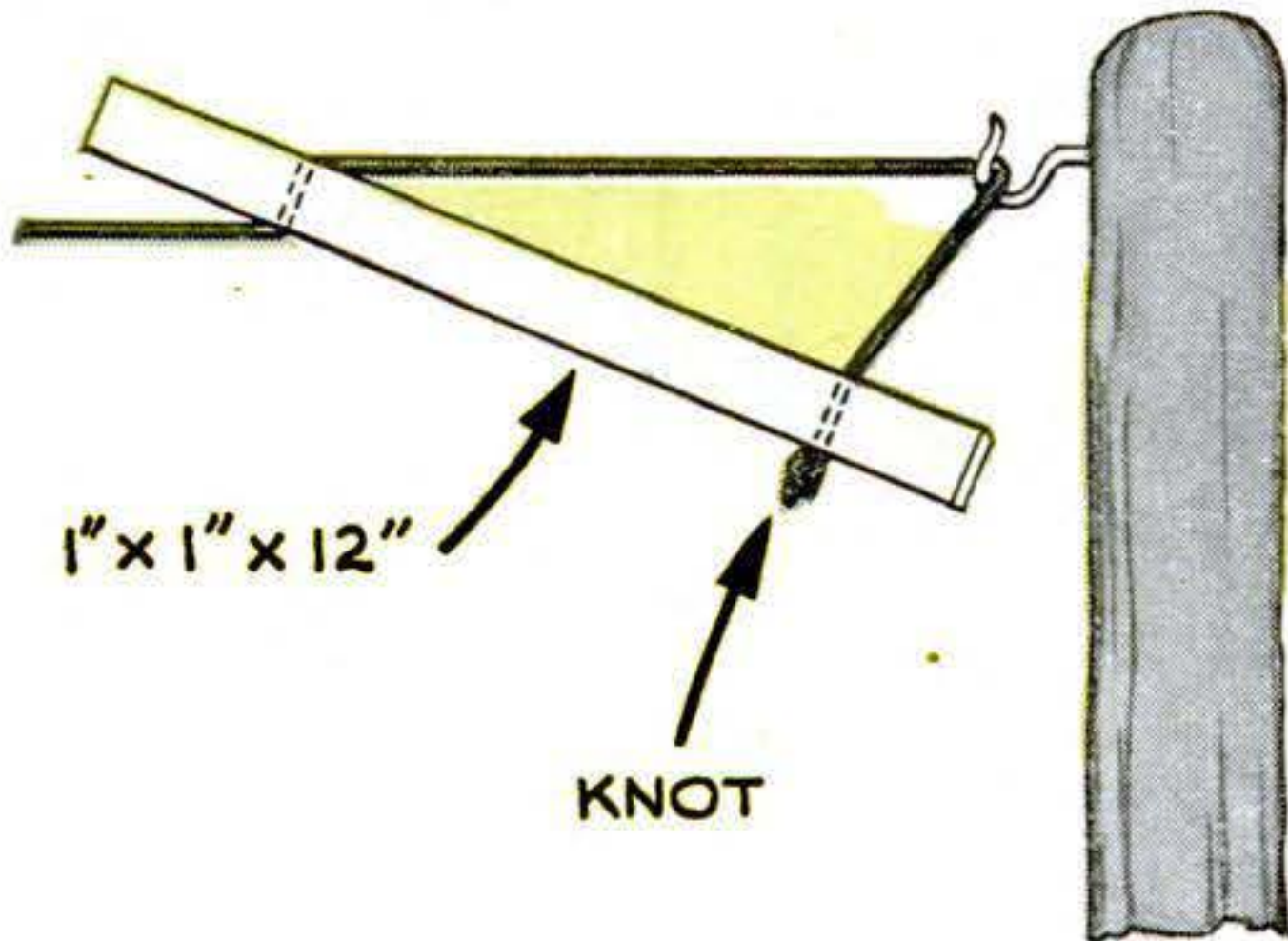

A clothesline can be taut though detachable if it is fitted with a tightener as shown. Slide the stick back until the line is tight; the weight of the clothes will keep it that way.



If you have to take a baby out into rain or snow, wrap him in a transparent plastic tablecloth. It will keep him and his clothing dry and allow him to see what's going on outside.



You need not discard a vase that has sprung a slight leak. Warm it, melt some paraffin, and swish this about inside to coat the bottom and sides. The waxy film will calk small holes.

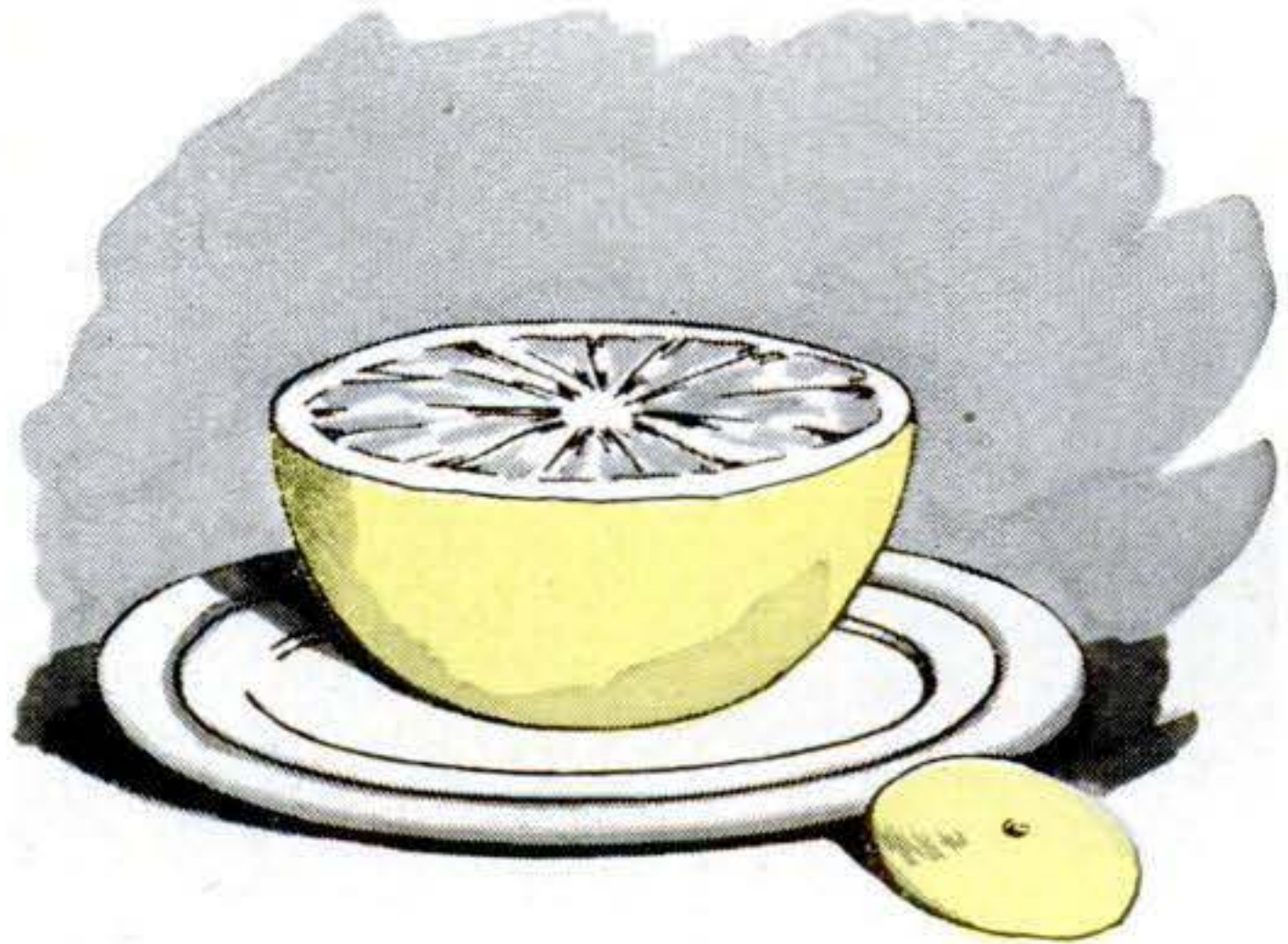

To keep grapefruit, canteloupe, and melons from sliding about on the plate, cut a flat on the bottom before serving. Be careful not to cut too deeply, or juices will escape.

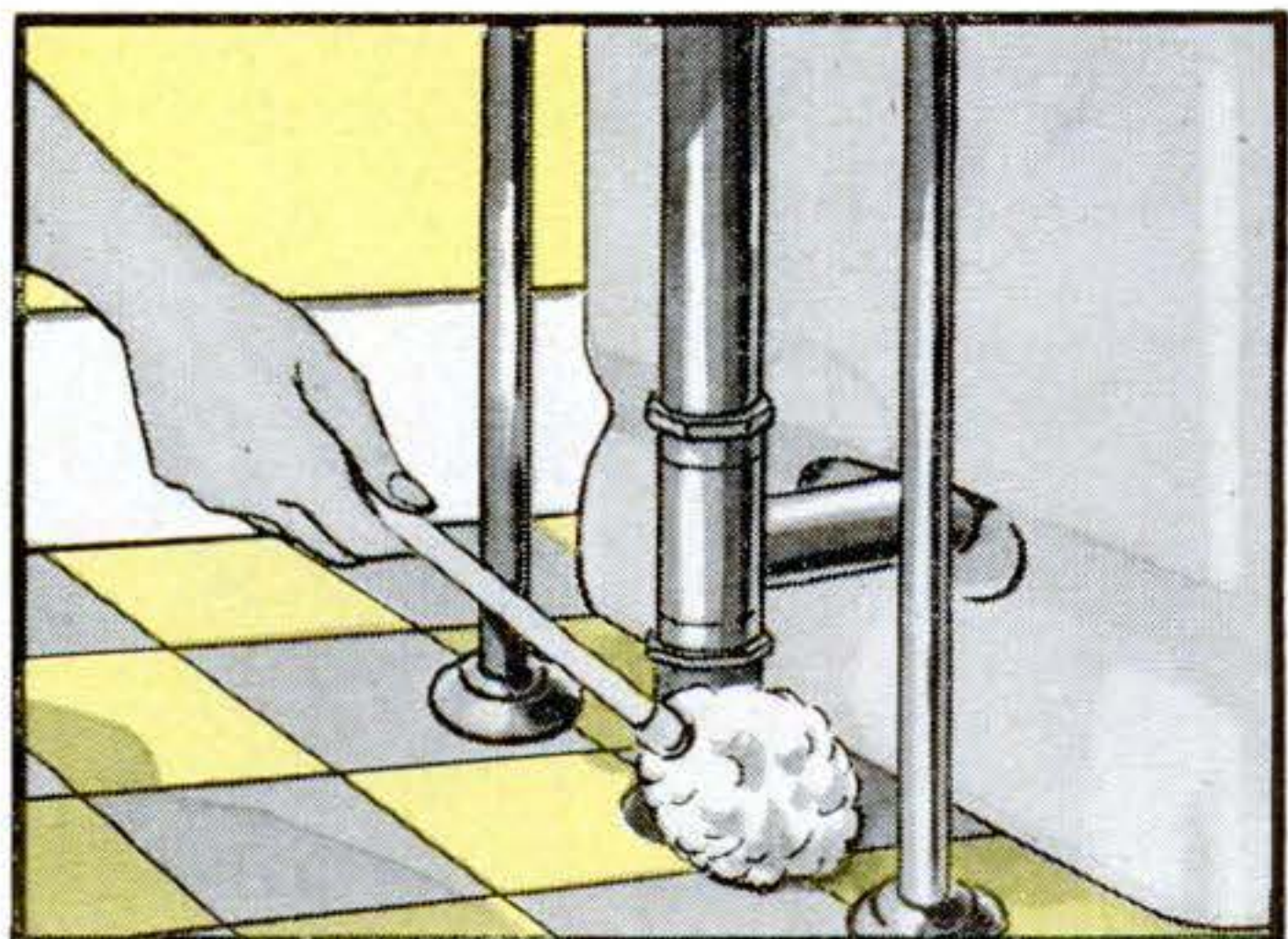

A dish mop makes a good floor mop for use under sinks or wherever there isn't enough room to swing a large mop. It gets between pipes and under radiators and furniture.

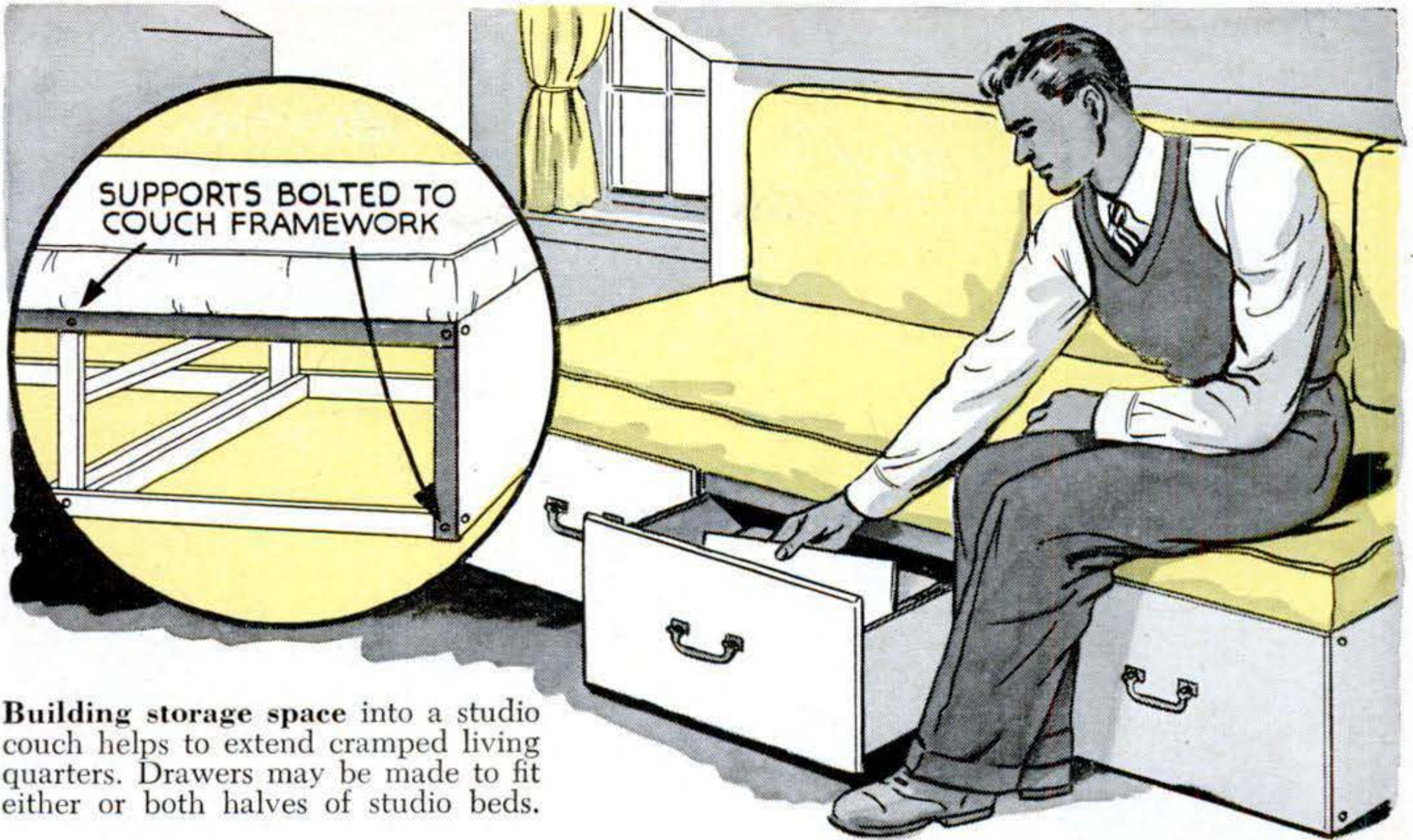

Building storage space into a studio couch helps to extend cramped living quarters. Drawers may be made to fit either or both halves of studio beds.

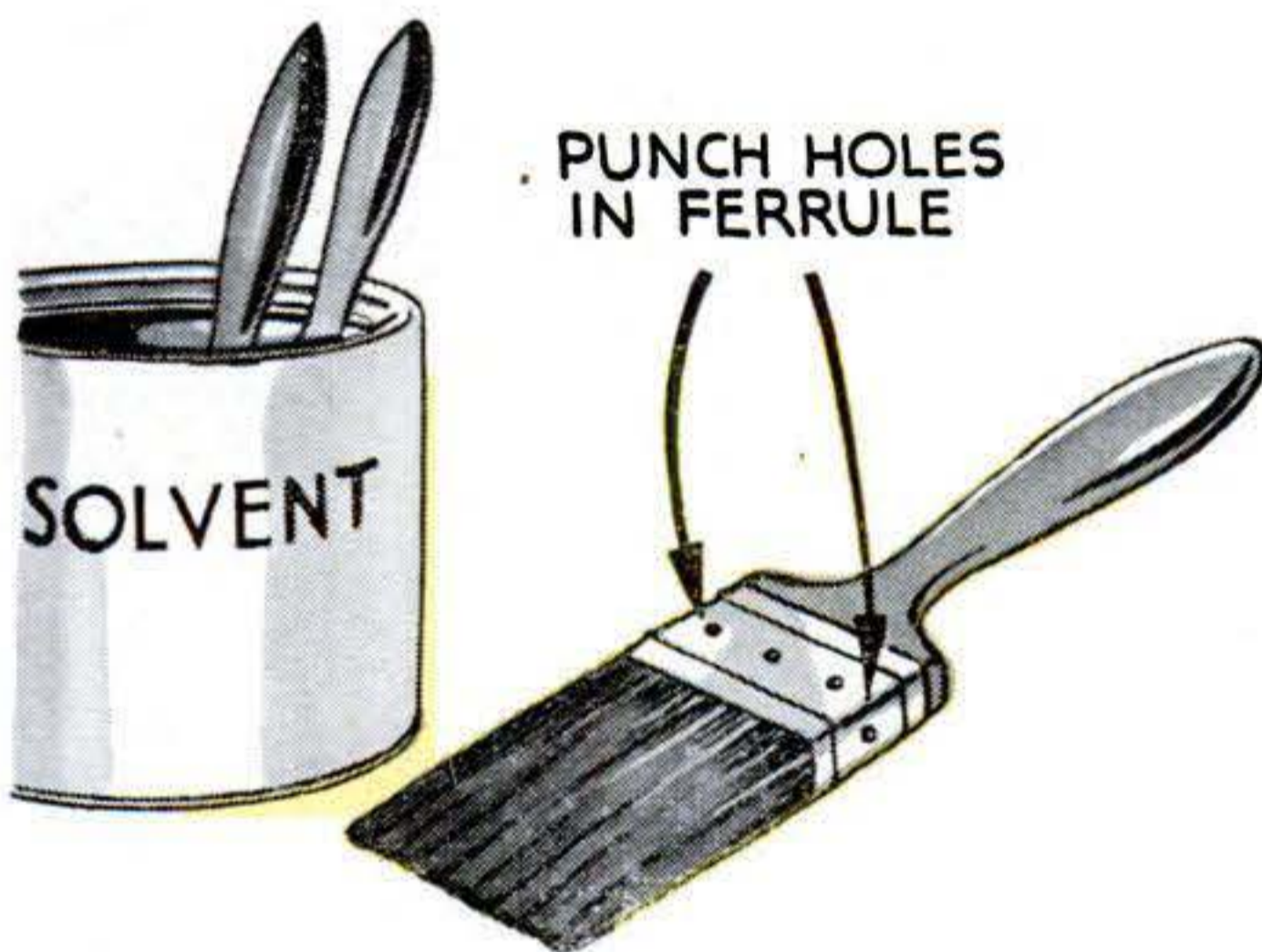

For faster, better cleaning of hardened paintbrushes, punch a few holes in the ferrule between the bunched bristles and the end of the handle. This lets the solvent work through.

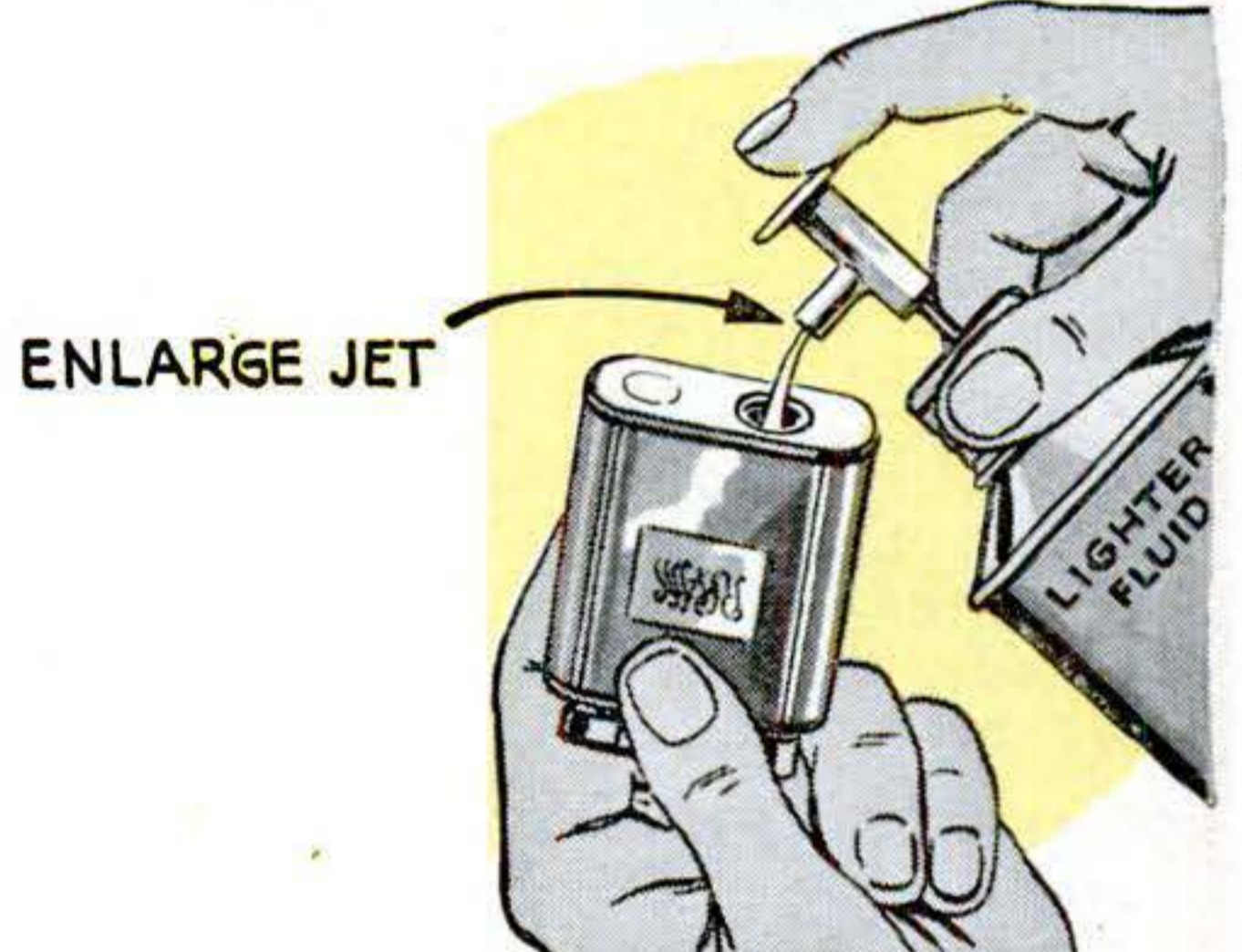

If you have trouble filling your lighter from a bottle that has no spout, obtain a screw-cap window-spray dispenser of the type shown. Cut the tube to fit the bottle and enlarge the jet.

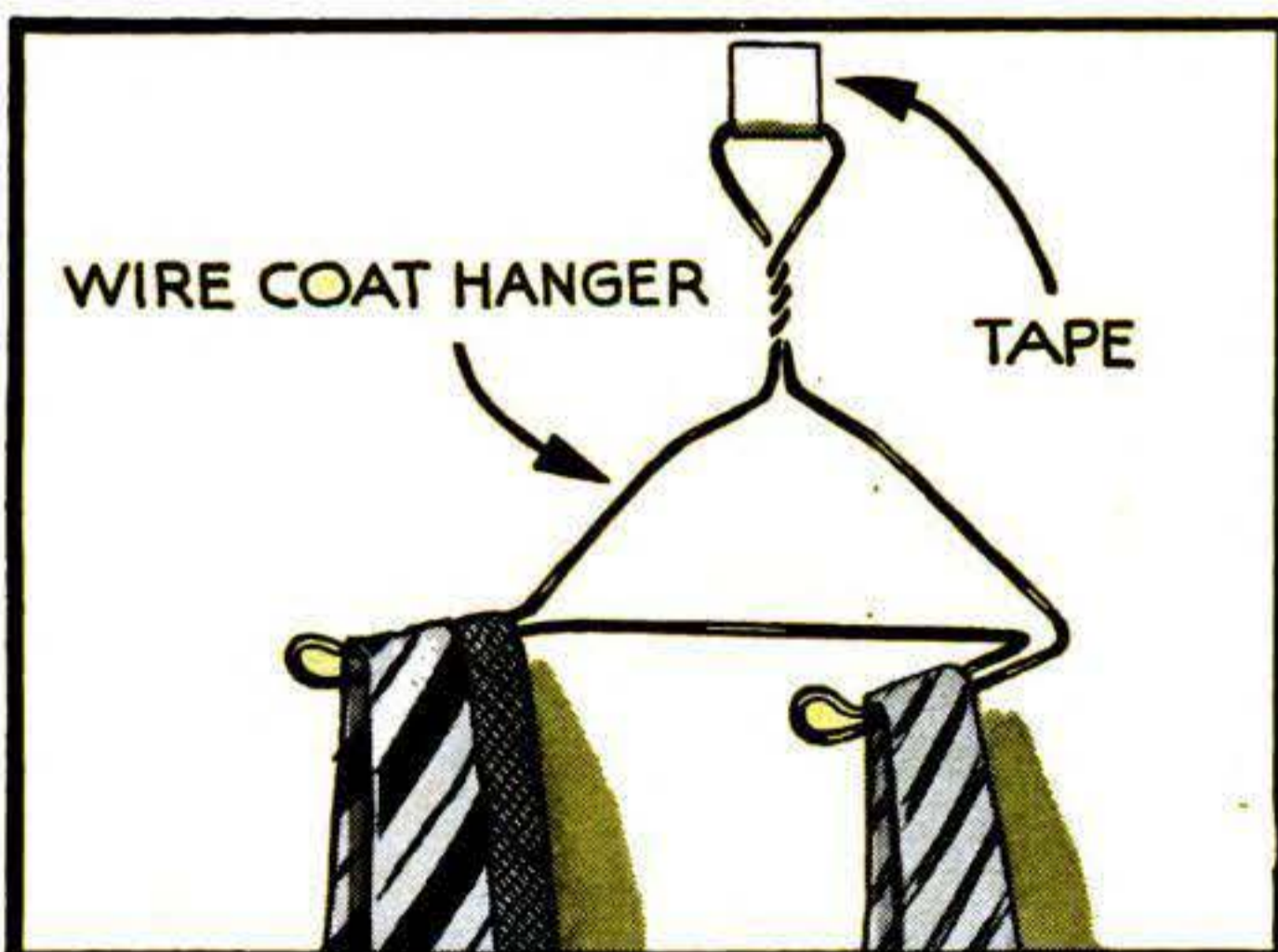

Tie racks can be made easily from wire coat hangers. Bend parallel legs for about 4" from each end; then turn the legs out at right angles. Hang the rack on the wall with tape.



Breaks or tears in collapsible tubes, such as those used for toothpaste and shaving cream, can be mended with strips of cellulose tape wrapped once or twice around the break.

Flat Storage Chest Rolls Out of Way Under Bed

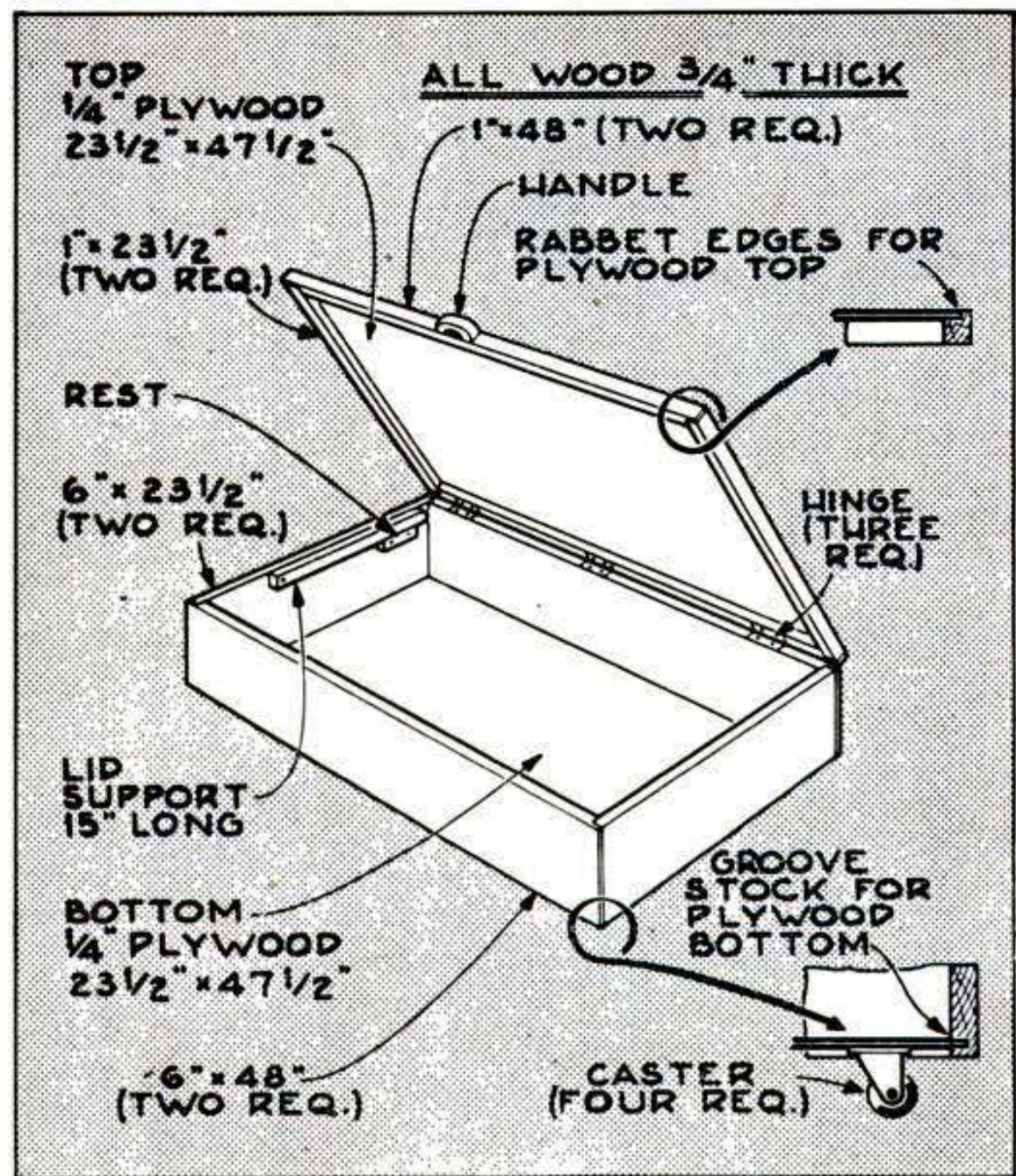
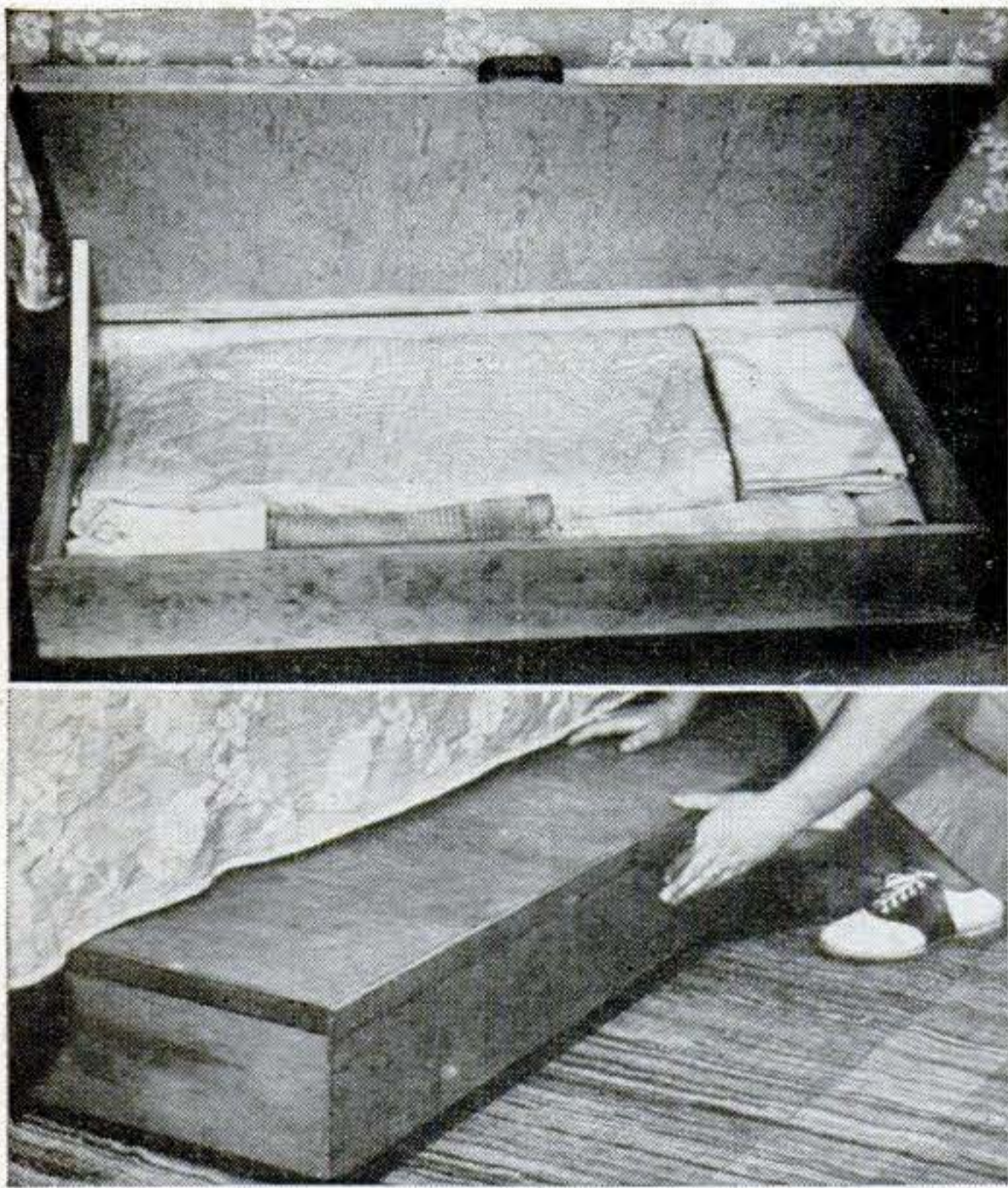

DESIGNED for use under a bed, this shallow chest solves the problem of where to store those extra blankets that overflow all available closet space. Mounted on casters, it may be moved easily when desired.

Except for the $\frac{1}{4}$ " plywood top and bottom, $\frac{3}{4}$ " stock is used throughout. As indicated in the drawing, the bottom is set in a $\frac{1}{4}$ " groove cut $\frac{1}{2}$ " deep into the sides and ends $\frac{1}{4}$ " from the bottom edge. Simple rabbet joints are used at the corners, rabbets $\frac{3}{4}$ " wide being cut $\frac{1}{2}$ " deep across the ends

of the 48" pieces. Assemble the box with finishing nails.

Rabbet joints also are used in making the top framework, and the plywood top is fitted flush by means of a rabbet cut around the inside edges of the frame. Attach the plywood with headless brads, and screw a handle to the front edge. Locate a lid support on the inner face of each end of the box, pivoting it on a screw at the forward end, and install a small block as a rest at the back.—ELMA WALTNER.

Infrared Lamp Speeds Up Work in Drafting Room

THIS simple device has opened up a production bottleneck in the drafting room where I am employed. Instead of having to wait for ink to dry before continuing a job, we now just snap on the light, hold it over the wet ink for a few seconds, and get on without the usual delay.

Because the heat is so rapid and intense, it is best to hold the lamp a bit above the surface to be dried. Since the sheet-metal shade is considerably longer than the conventional reflector, it also serves as a convenient rest for the lamp when not in use—

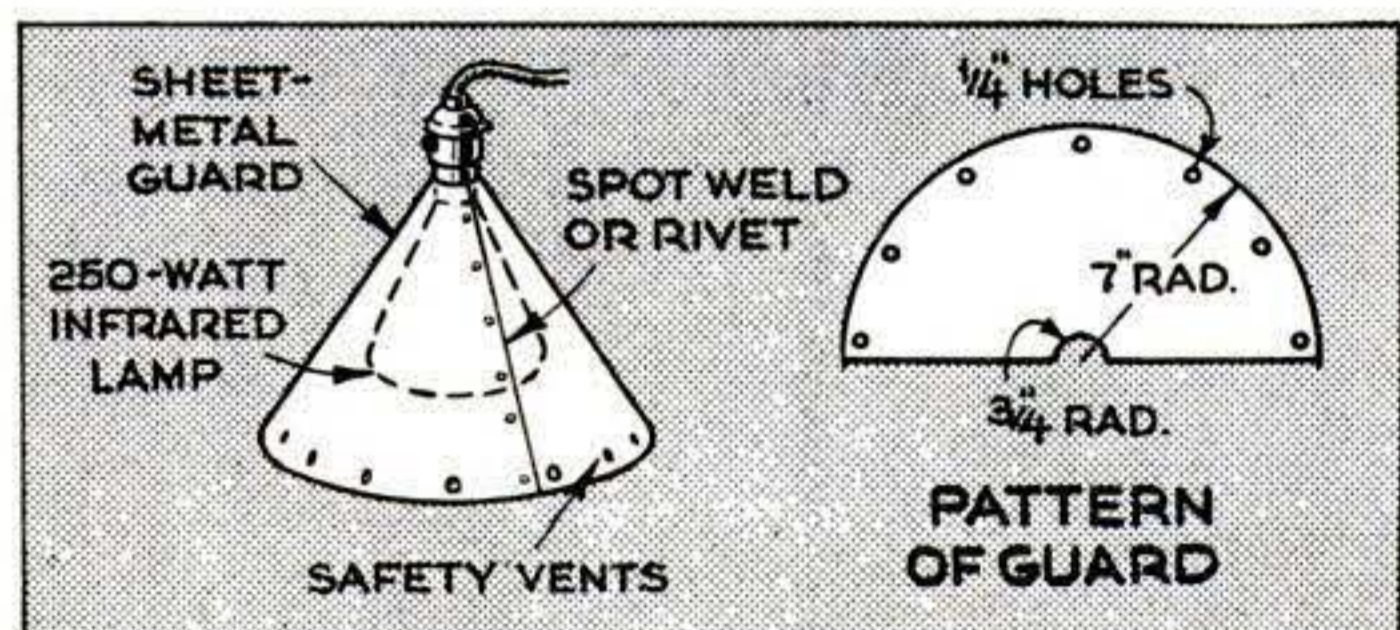

as well as providing a safety guard in case the bulb should shatter. The holes in the shade lessen the possibility of someone leaving the light on by error.—ROBERT DELSON.

Spool Substitutes as a Level

WHEN a carpenter's level is not available, a typewriter ribbon spool makes an excel-

lent substitute if the surface is smooth. Put down on edge, it will indicate even a very slight incline by rolling toward the area that is lower.—FRANK SHORE.

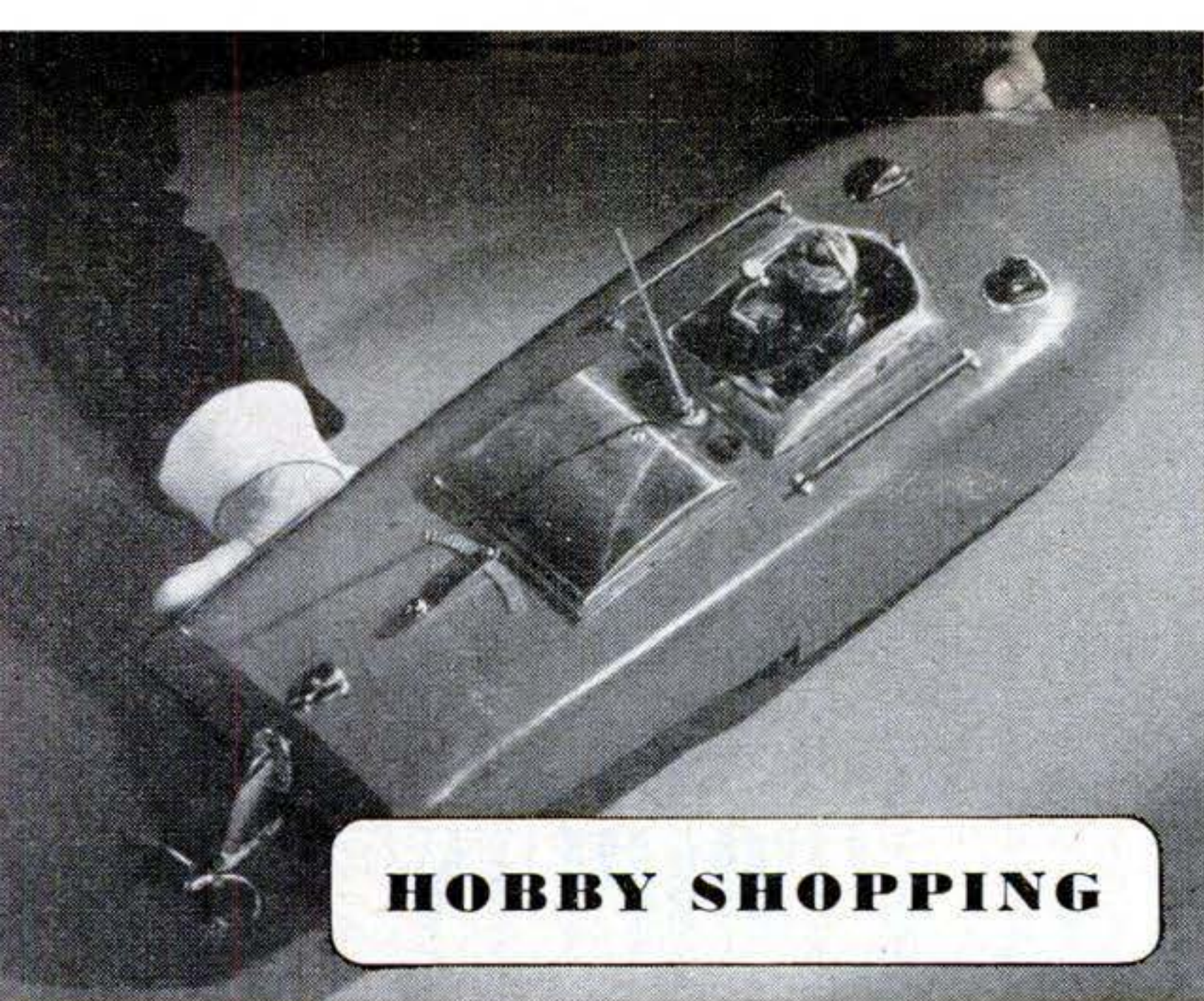

HOBBY SHOPPING

Boat Has Plastic Hull. Supplied in kit form, this speedy hydroplane has a molded plastic hull. Quickly assembled with only simple tools, the boat is 25" long, has a beam of 7 $\frac{3}{4}$ ", a maximum depth of 3 $\frac{3}{4}$ ", and weighs only 34 oz. without its air-cooled gas engine. Special molded ribs increase the strength of the hull, enabling it to withstand shock and vibration. The boat is manufactured by Reuhl Products, Madison, Wis.

Fly by Thumb.

A new plastic control for control-line model planes has a wheel that may be operated by thumb to raise or lower the elevators. Victor Stanzel & Co., of Schulenburg, Tex., makes the handle.



Pistol Has Various Uses. An air pistol introduced by Healthways of Hollywood, Calif., is supplied with two interchangeable barrel nozzle attachments. These make it possible to shoot corks, darts, BB's, or imitation bullets—just as you choose. Sold for about \$4 with a supply of each projectile type, the pistol is accurate within 20'.

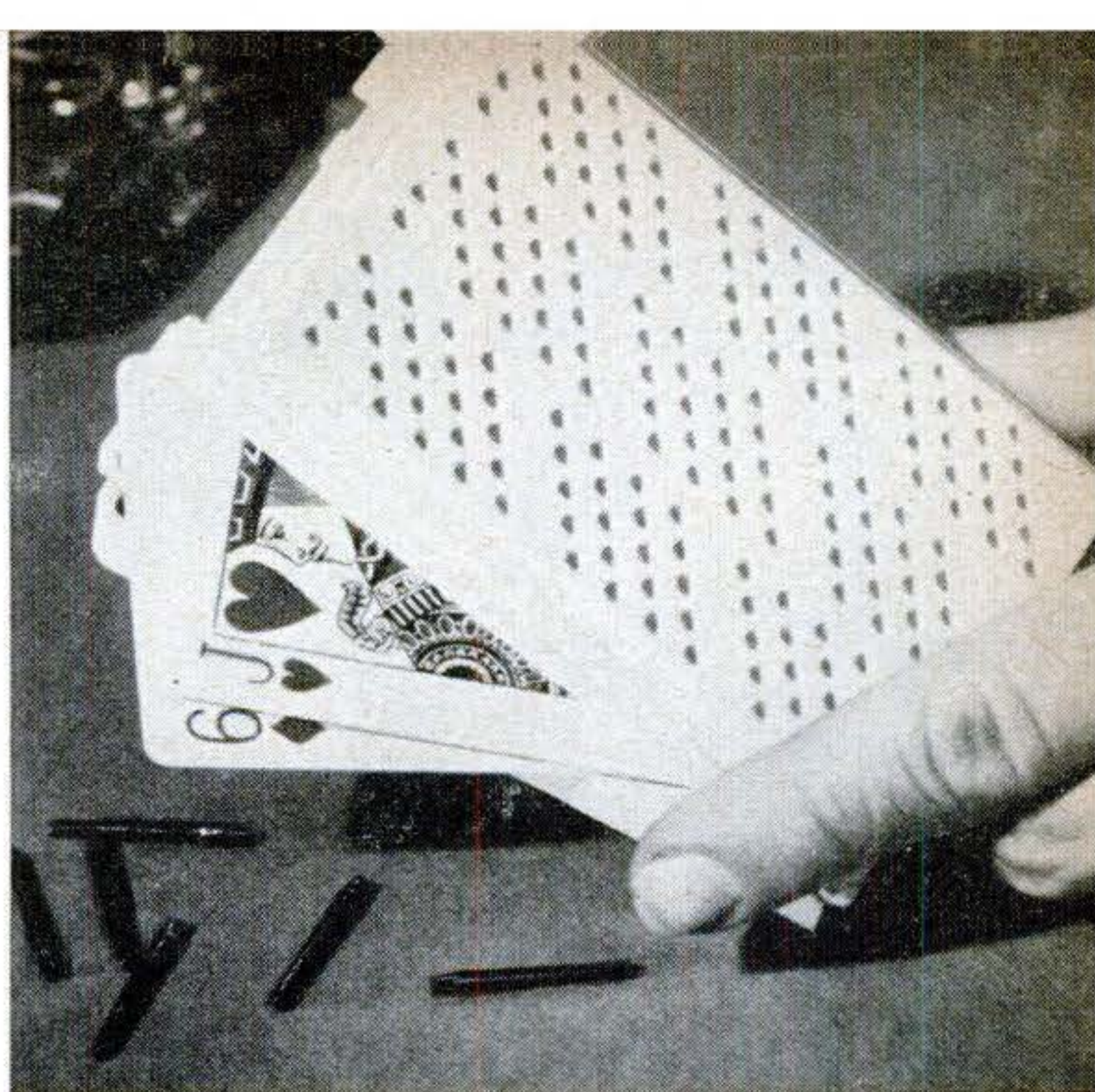

Cribbage Game Fits Pocket.

Made of lightweight plastic, this portable cribbage set fits easily in the hand or vest pocket. Opened flat, it forms a standard cribbage board. Closed, it serves as a container for a deck of cards and the score pegs. The price is about \$2, and the manufacturer is Kencroft Associates, Inc., of Buffalo, N.Y.



Plastics Kit Available. Materials needed for internal carving of plastics (PSM, Aug. '47, p. 160) have been assembled in kit form by the Chicago Wheel & Manufacturing Co., of Chicago. The kit includes special cutters, sanding disks, buffing and polishing compounds, polishing wheels, plastic dyes, and cements.



**HANDICRAFT
FOR
CHRISTMAS**

Last-Minute Gift Projects

Here are seven handsome home accessories that you can make in a jiffy from a few Venetian-blind slats.

By R. J. DeCristoforo

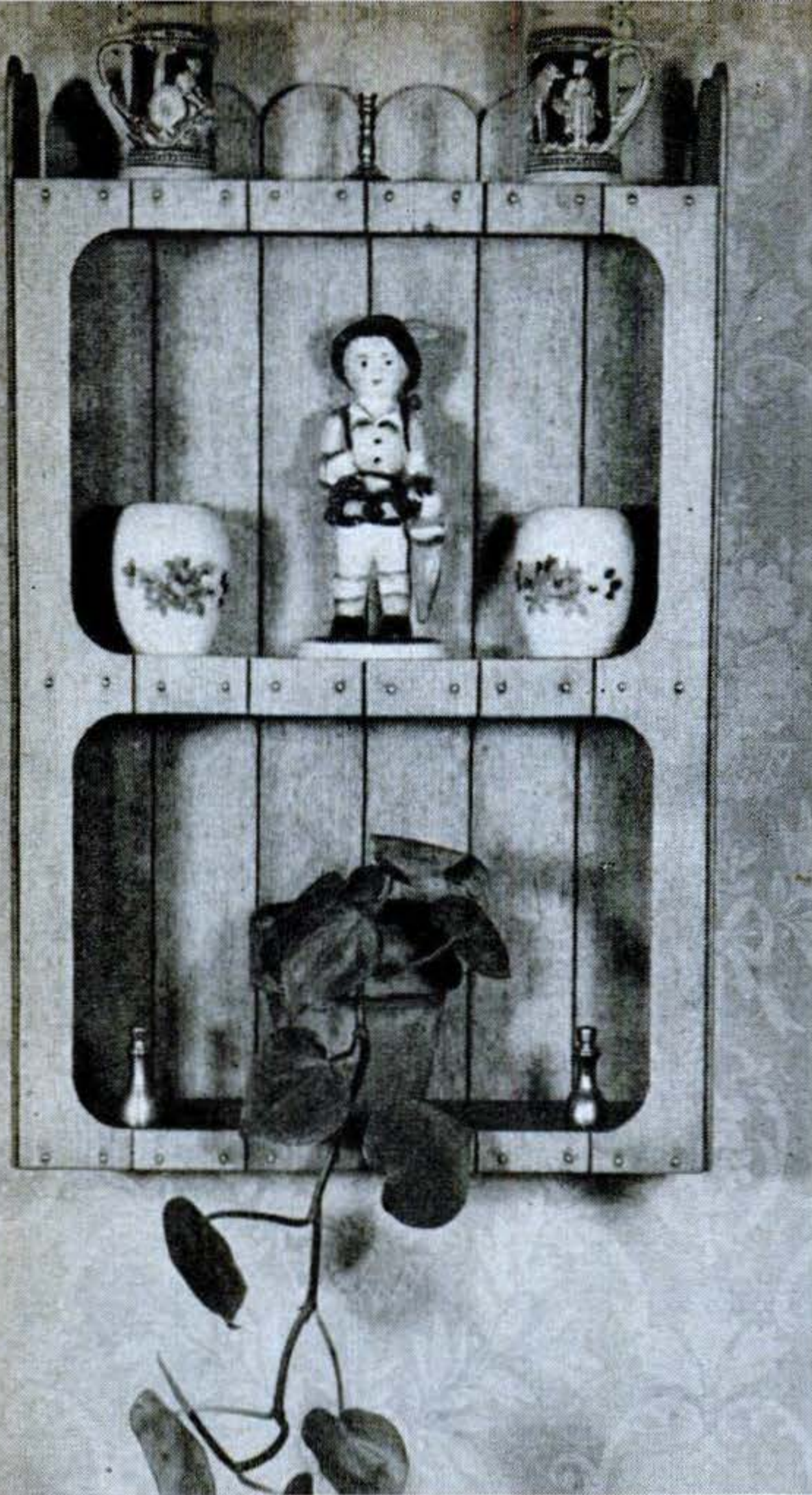

Knickknack Shelf. Painted or stained, a pair of these shelves will help dress up a bare wall.

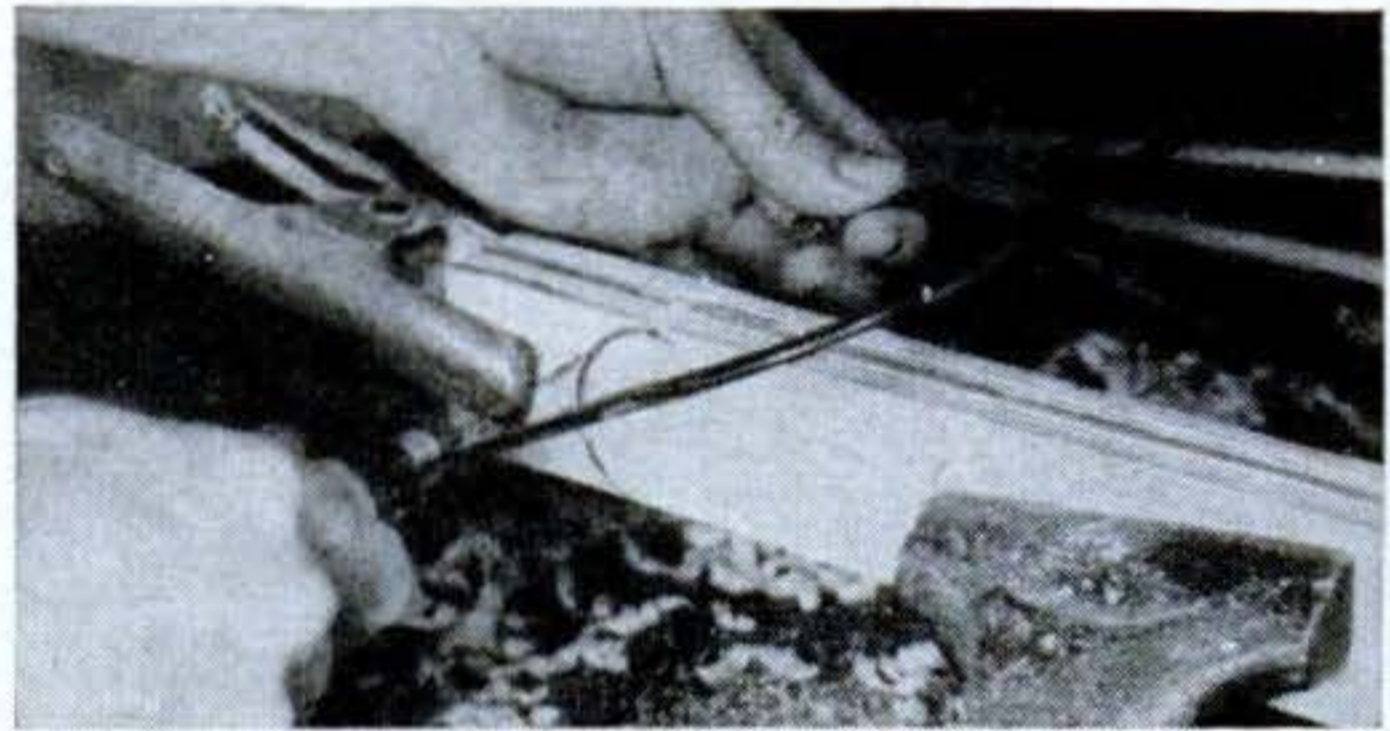

Several slats may be sawed simultaneously if clamped in a vise. Sandpaper the cut edges.

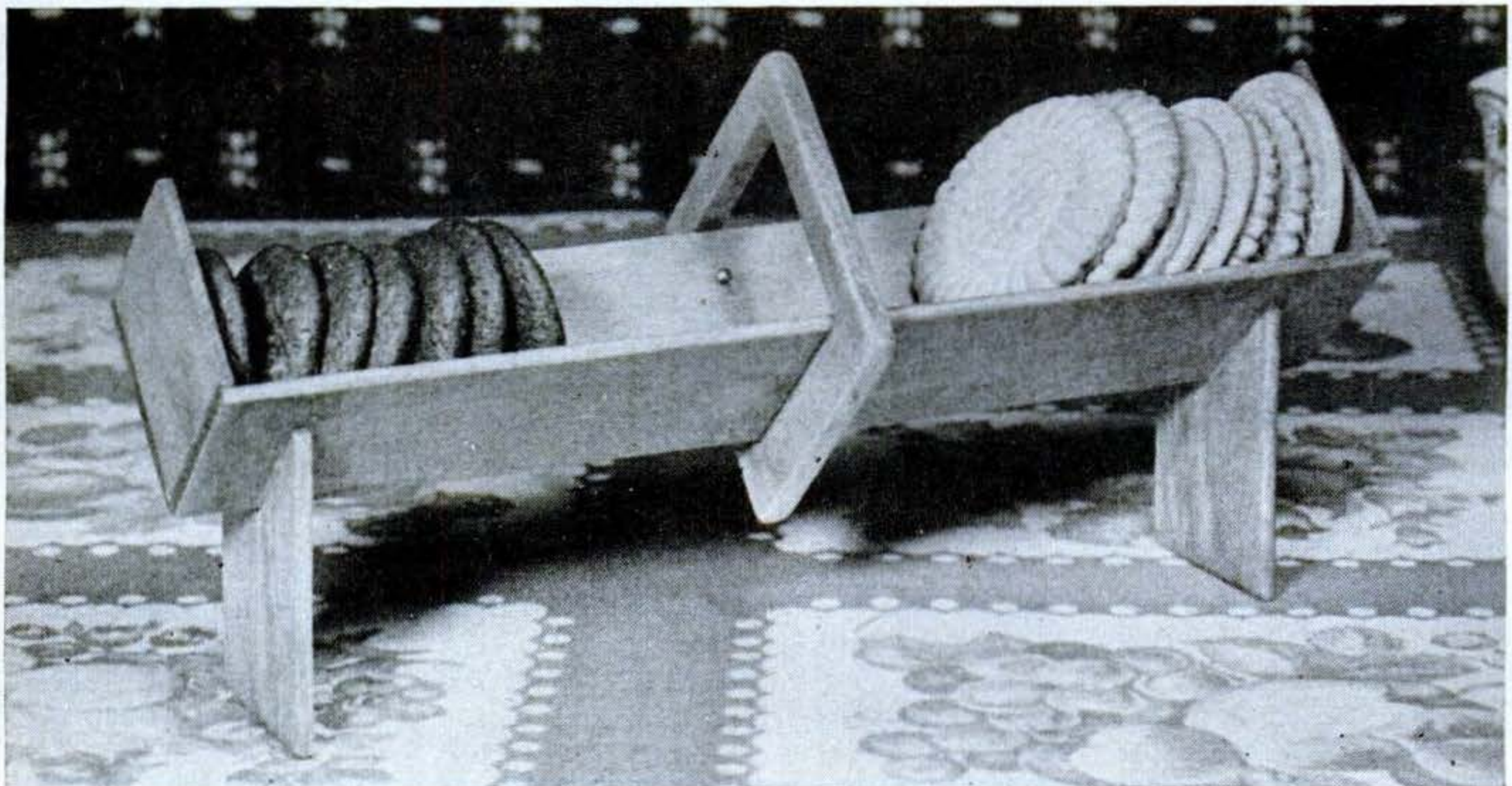

Cookie Server. Although dainty and fragile in appearance, it is quite strong. The handle is

a square frame cut from $\frac{1}{4}$ " stock. Remember to slide the handle on before attaching the feet.

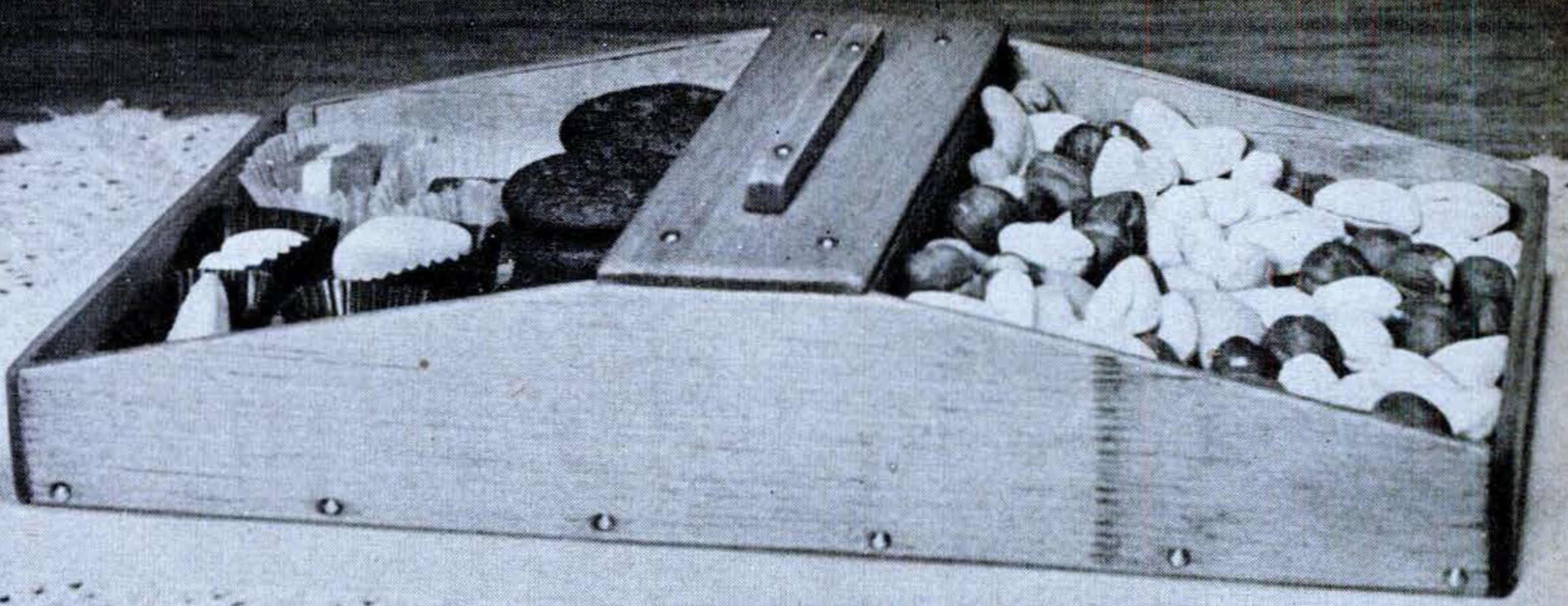

Candy Tray. The lid in the center covers a narrow receptacle that may be used to store

matches or other small articles. Cleats under the lid will prevent it from sliding off the box.

QUICKLY made at little cost, these gift items all use new Venetian-blind slats. Made of good wood, such slats are a pleasure to work with, for they come in various widths, have nicely rounded edges, and are smoothly finished, ready for staining or painting. A local Venetian-blind manufacturer probably will sell you cutoffs for a few cents, or failing that, you can buy a supply from a mail-order house.

The slats may be worked with just a few simple tools. A coping saw is good for cutting curved pieces. When it is necessary to make a lengthwise cut, a sharp knife and a straightedge will do a good job. Edges may be smoothed and rounded with sand-

paper, and sandpaper wrapped around a block enables you to make bevels where desired.

Simple butt joints and brass escutcheon pins were used in making the projects pictured. To avoid splitting the wood, it is best to drill small holes for the pins. For greater strength, coat mating areas with glue before driving home the pins. Although slats take paint readily, the seven projects were finished in this case with a maple oil stain and then waxed.

The wall shelf is large enough to be a unit on its own, yet of a size that will permit hanging in pairs. It is 17" high and the width of six 1 1/4" slats loosely spaced. Two

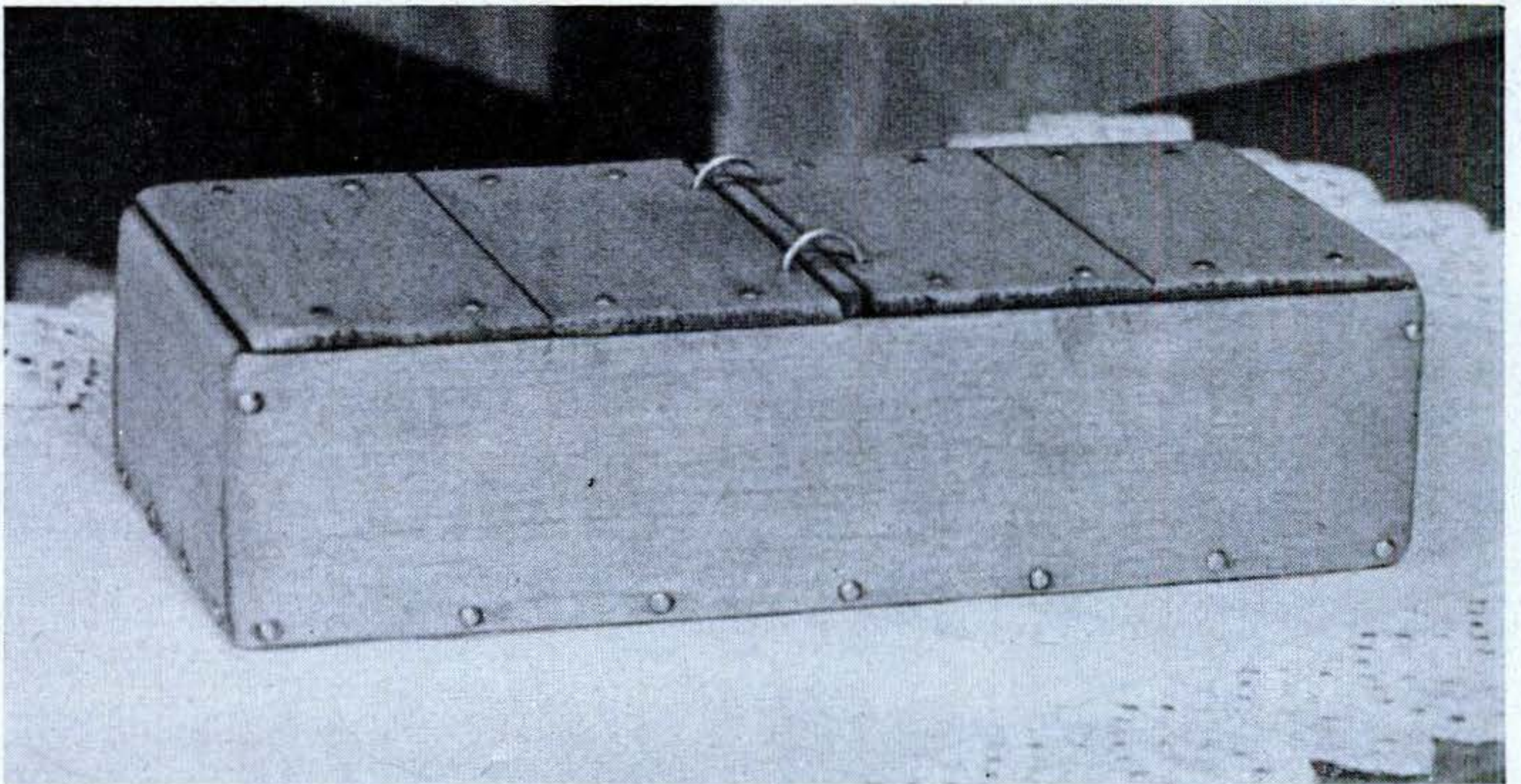

Cigarette Box. Two brass rings hinge the two lids, the rings being placed in holes drilled

in the lids and center partition. A cleat on each lid would make it easier to open the box.

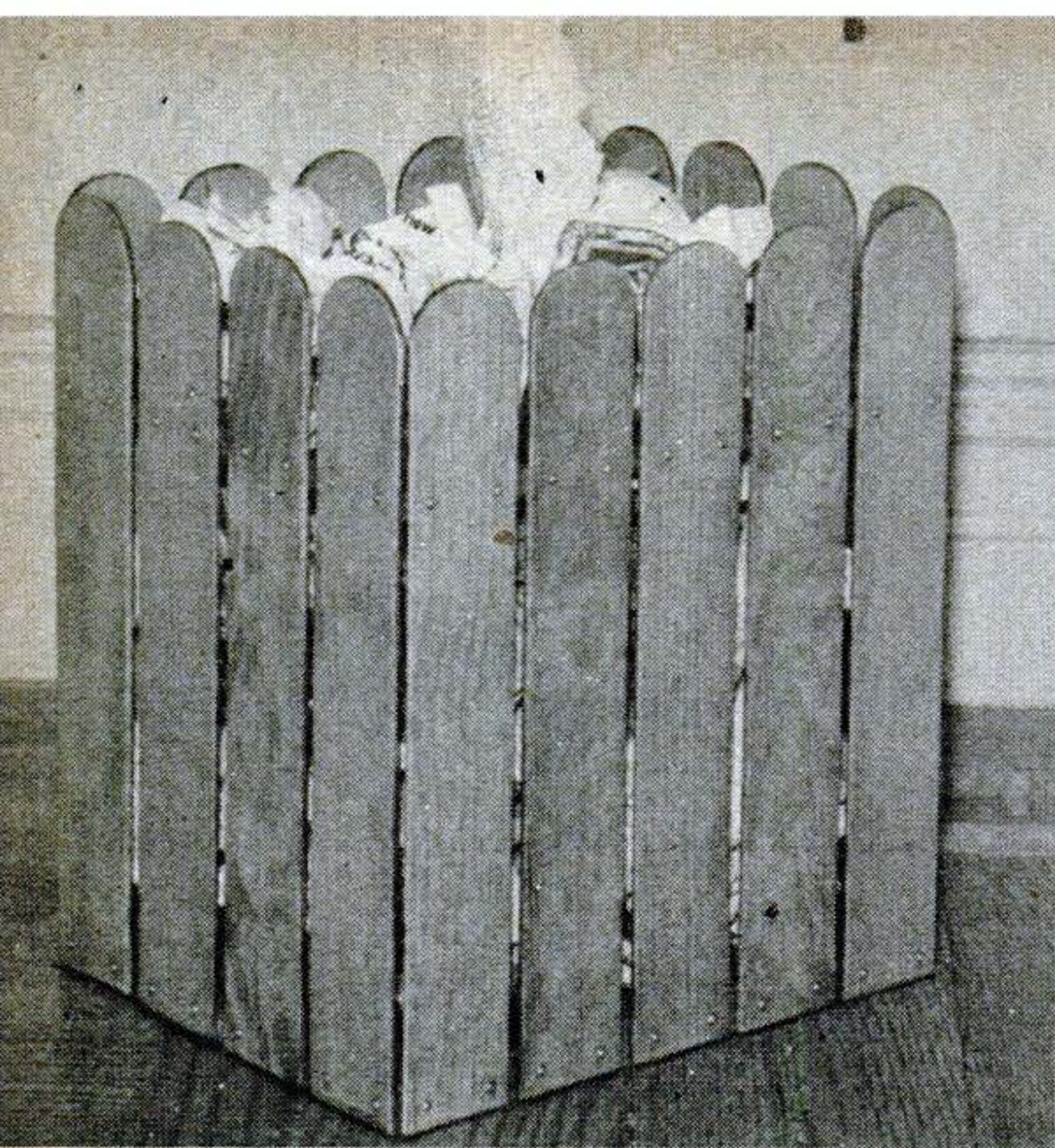

Wastebasket. Lined with cardboard, it may be used to empty ashtrays, but watch live butts.

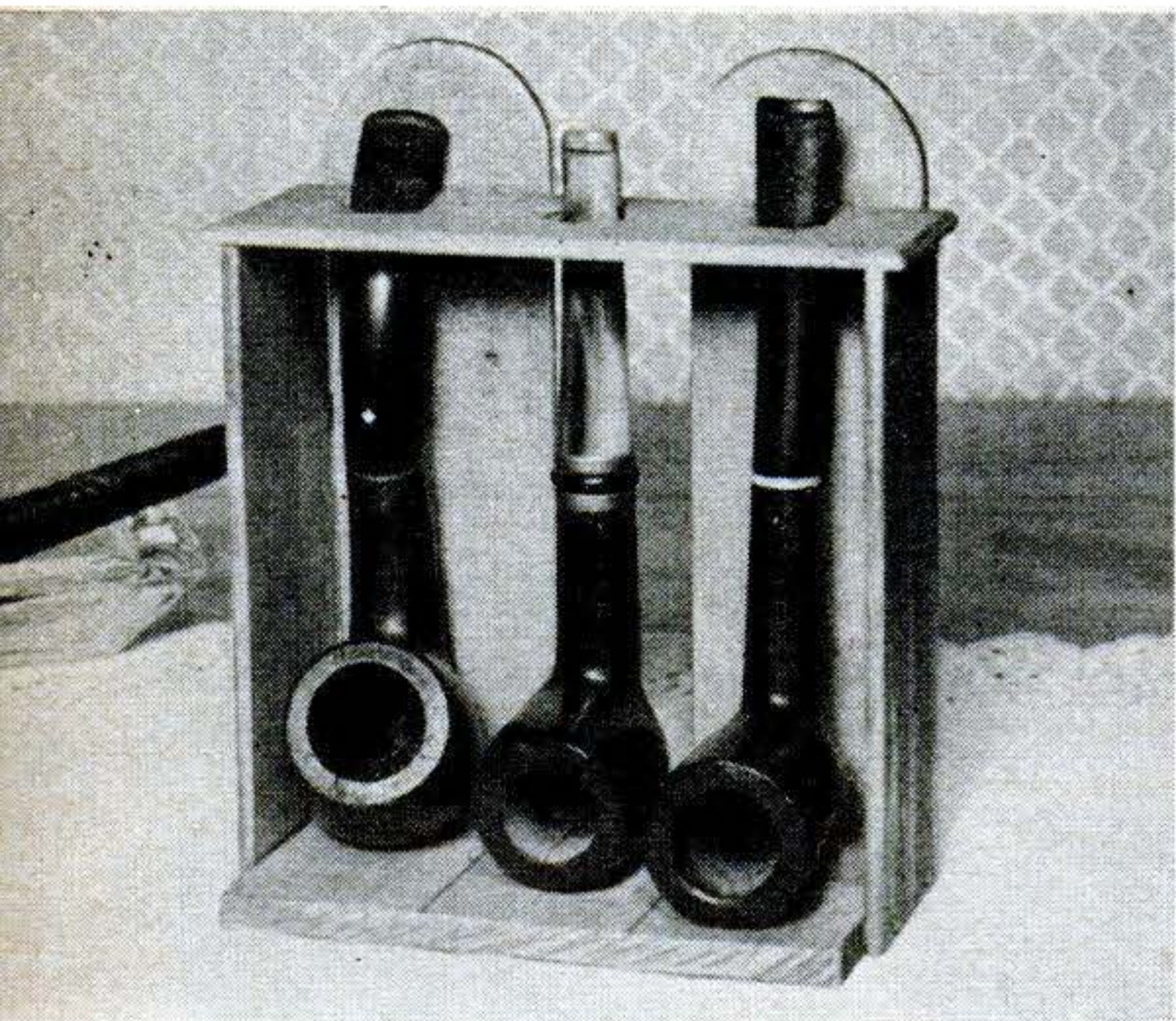

Pipe Rack. Lengthen to take additional pipes if the man who'll get it has more than three.

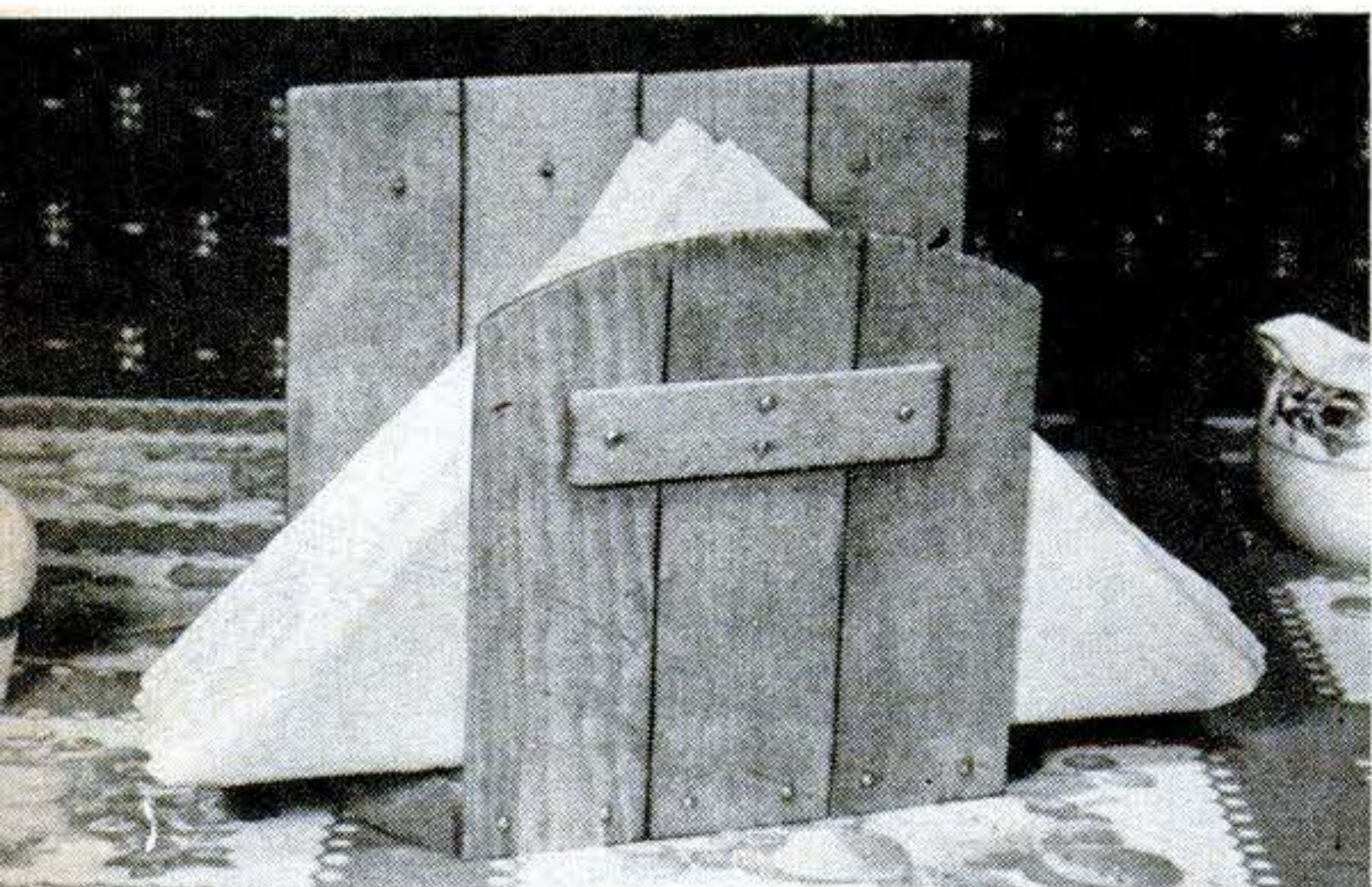

Napkin Holder. A natural finish and the heads of brass pins give it an old-time appearance.

slats butted together make the $3\frac{1}{2}$ " sides. All are nailed around three shelves cut from $\frac{1}{2}$ " stock and spaced $6\frac{3}{4}$ " apart. It would be wise to lay the slats side by side to the required number and measure them so that you can cut the shelves to suit. The pieces used to edge the front of the shelves are $\frac{1}{2}$ " lengths cut from $1\frac{3}{4}$ " slats.

A $1\frac{5}{8}$ " slat is butted against the edge of a $1\frac{3}{4}$ " slat to form the trough of the cookie server. The ends are $1\frac{5}{8}$ " squares butted inside the trough, and the uprights are $1\frac{3}{4}$ " by $2\frac{1}{2}$ " with a 90-deg. notch. Made of a $2\frac{3}{4}$ " square of $\frac{1}{4}$ " stock, the handle is cut out in the middle to fit the trough. The joints may be glued.

For the cigarette box, sides and ends $1\frac{1}{8}$ " wide are fitted around a bottom of $\frac{1}{4}$ " stock, forming a box $3\frac{1}{4}$ " by $7\frac{1}{2}$ ". A partition is fitted midway, and the two lids are hinged to this with brass rings. Small holes should be drilled simultaneously in both covers and the partition so that the brass rings line up perfectly. The lids each are made of two pieces joined by cleats below.

The candy tray is a structure similar to the cigarette box, but the sides are cut on a slope and two partitions and a loose-fitting cover form a closed receptacle in the center. A piece tacked underneath keeps the lid from slipping. Outside dimensions of the tray are $5\frac{3}{4}$ " by $10\frac{1}{4}$ ".

For the bottom of the wastebasket, cut a square from $\frac{3}{4}$ " stock. Slats 12" long are nailed to it and to a square framework located 9" from the bottom. This frame may consist of $\frac{3}{4}$ " square stock assembled with butt joints. For uniform spacing of the slats and a pleasing effect, it's wise to lay the slats on a flat surface, spacing them as desired. Then measure across them and cut the bottom and frame accordingly. In this case, $1\frac{3}{4}$ " slats were spaced $\frac{1}{4}$ " apart.

Simple and pleasing in design, the pipe rack has a $2\frac{3}{8}$ " by $4\frac{1}{2}$ " base, cut from $\frac{1}{4}$ " stock. The slat framework is strengthened by a $\frac{1}{4}$ " square cleat (not seen in the photo) nailed under the $1\frac{1}{8}$ " by 5" top, the latter being beveled on three edges to soften the lines of the rack. The two back slats are $1\frac{1}{8}$ " by 6" and the sides are $4\frac{3}{4}$ " high. If desired, small partitions may be placed on the base between the bowls.

Built on a $\frac{3}{4}$ " by 3" by 6" base, the napkin holder stands $6\frac{1}{2}$ " high at the back and 6" in front. Cleats hold the front and back slats together. Rounding all edges improves the appearance. END

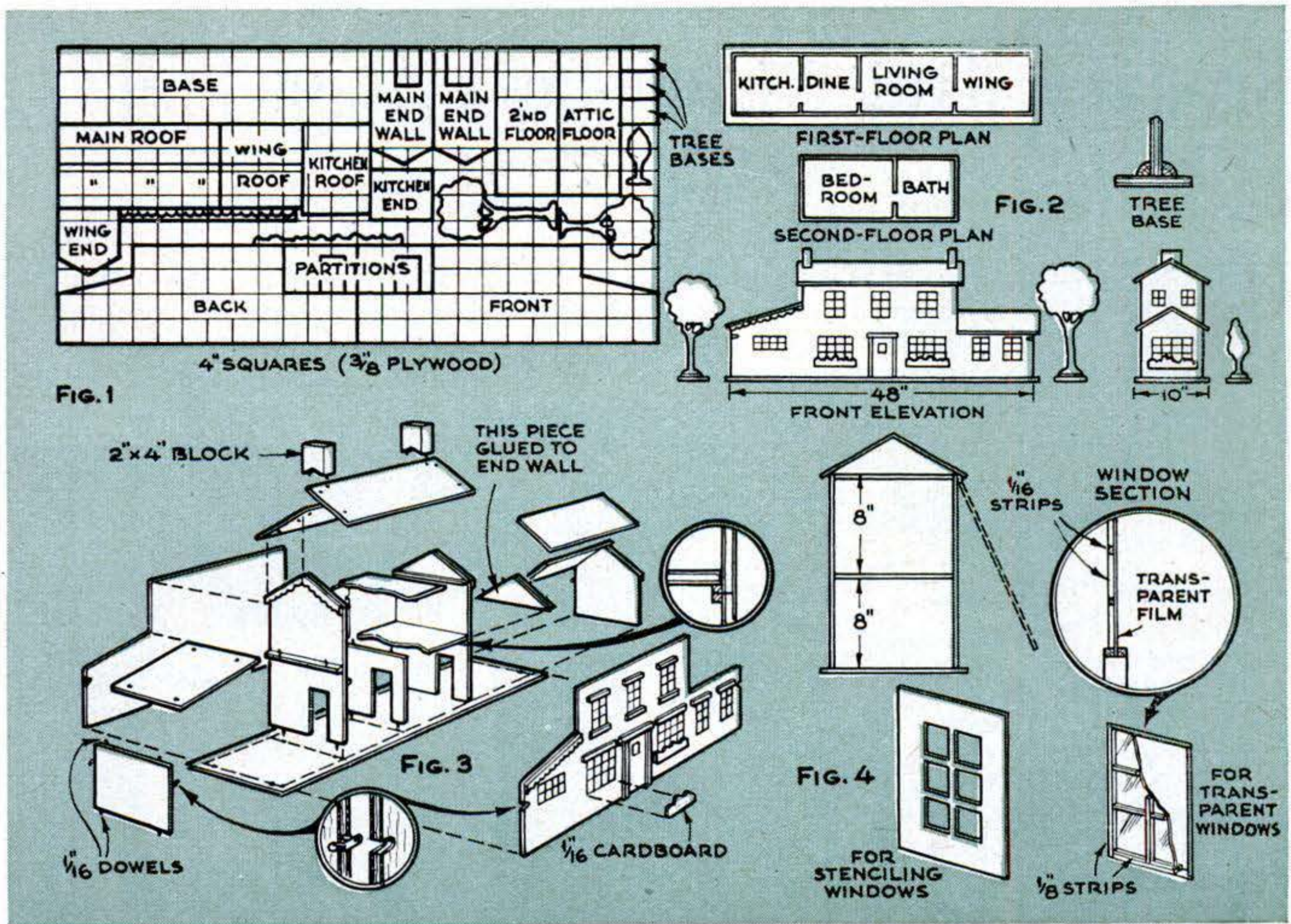

All structural parts of this doll house are cut from a single 4' by 8' sheet of $\frac{3}{8}$ " plywood.

Four-Foot Doll House Stores Flat

By Hi Sibley

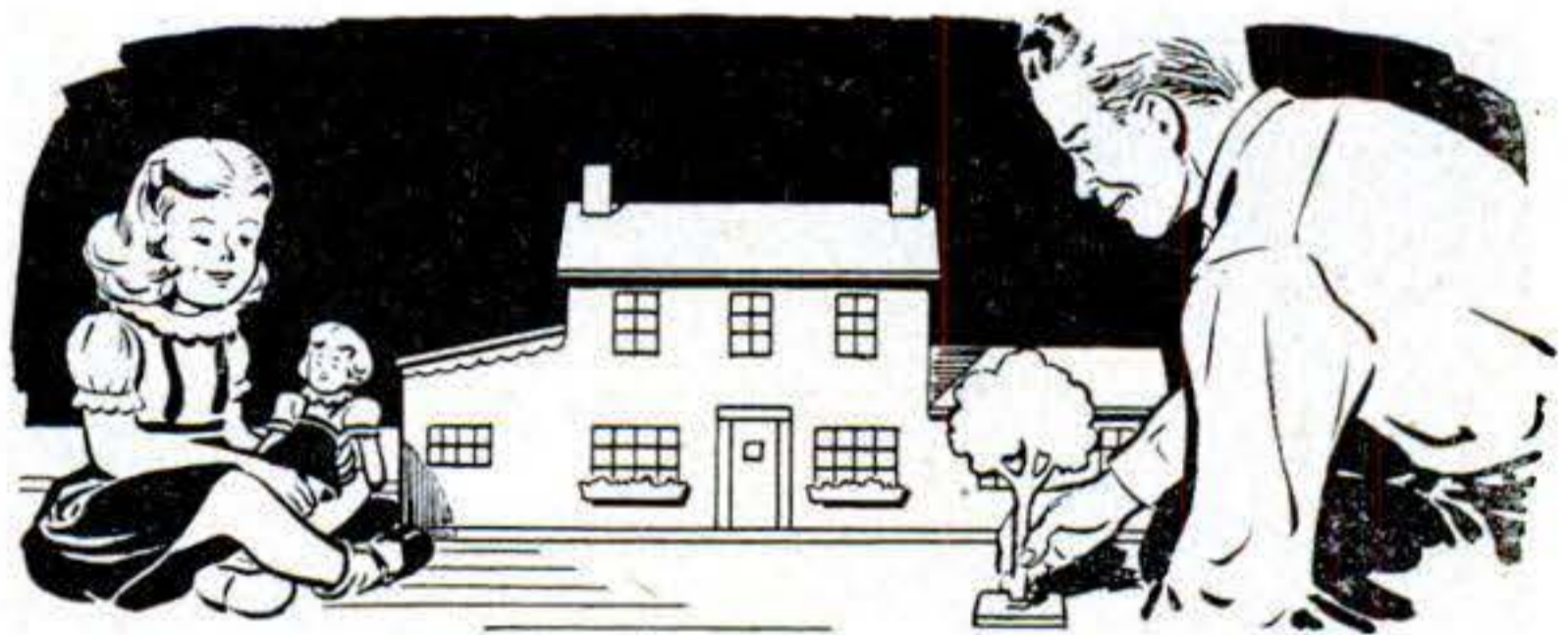

IT'S A GIFT

THERE must be some little girl on your Christmas list who has written to Santa for a real big doll house. Her mother probably didn't mail the letter because she knows that a big house for daughter's dolls won't leave much space for the rest of the family. But Santas who know all about housing shortages and small apartments can please both generations with a house that can be folded away in a jiffy.

One panel of $\frac{3}{8}$ " plywood supplies all the material needed except for dowels and a few strips of pine. Lay out the pieces as shown in Fig. 1. Appearance of the completed house is illustrated in Fig. 2. The front wall lifts off to give access to the interior.

Assemble the pieces as shown in Fig. 3. Small dowels with rounded ends are installed where indicated, and slightly larger holes are drilled in the matching pieces. End walls of the two-story part and of the wing and kitchen are dowel-fastened to the base, and the rear wall is added. Put in the partitions and floors, and then the roof and chimneys. The front wall goes on last; both it and the rear wall are secured by turn buttons as shown in the lower inset detail of Fig. 3.

If you want a simple job, stencil the windows in blue and put a frame of thin wood around the door. Transparent windows set in openings are made as in Fig. 4. Carved valances and window boxes are attached with brads and glue.

Grenade Bank "Explodes" When Full

By Jack Mellinger

UNLESS you choose to smash it with an axe, you'll never succeed in robbing this bank when you're short of change. The only way to get back the pennies, nickels,

or dimes already in it is to put in more—and more—until the bank is full. Then, the last coins unlatch the mechanism and allow the two halves to fly apart.

After turning the halves from softwood, cut the indicated grooves in the side with

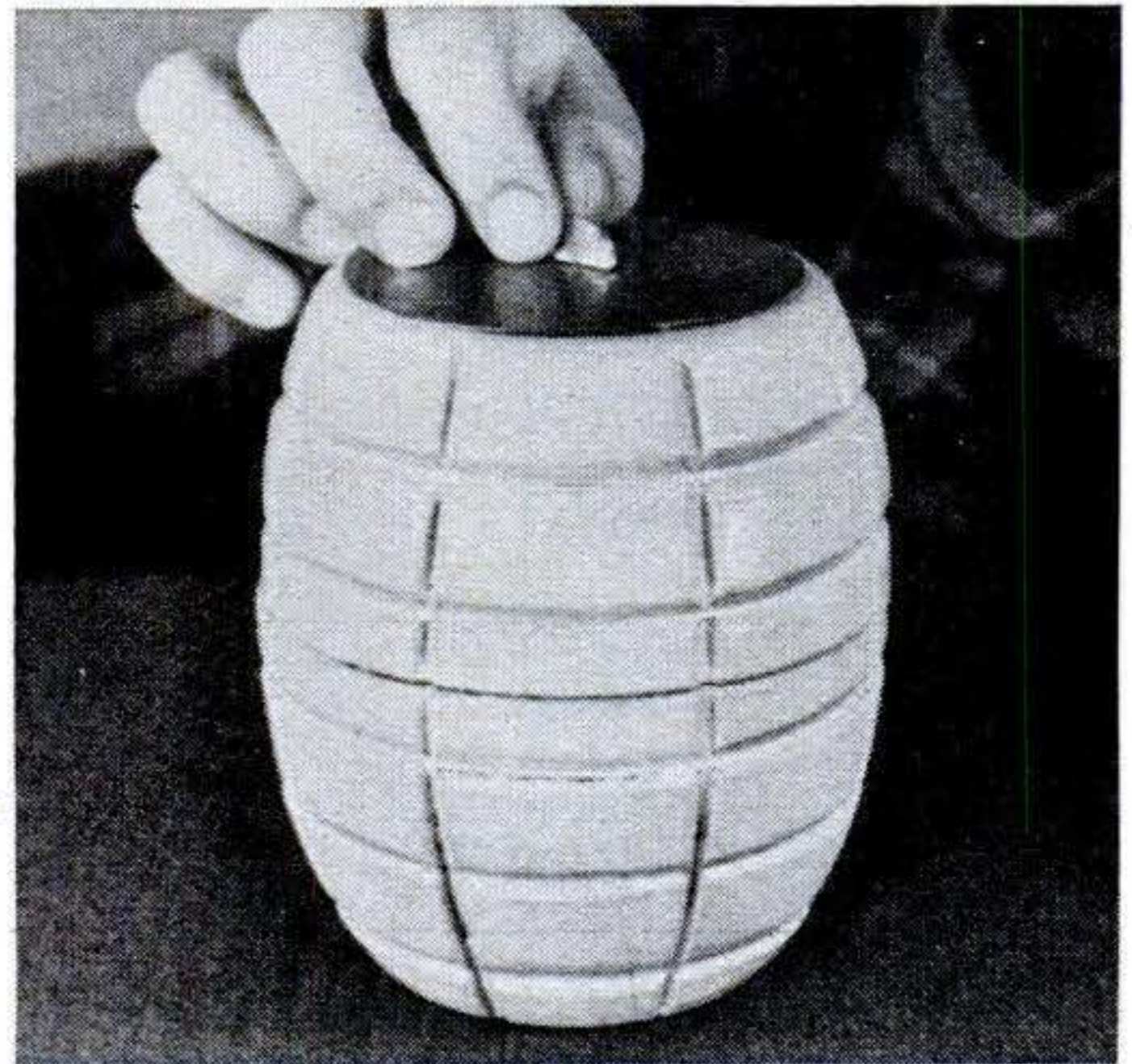
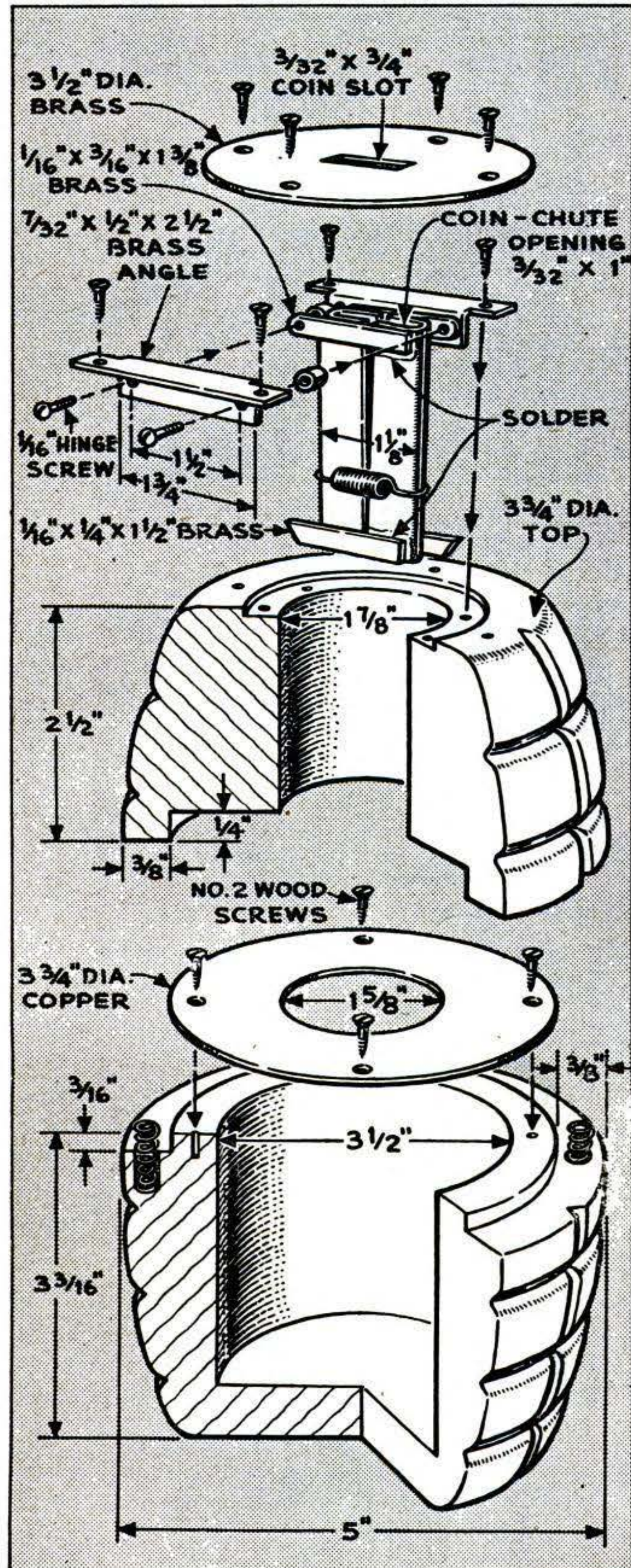

When the bank is full, the final coins force the chute halves apart, letting the bank open.

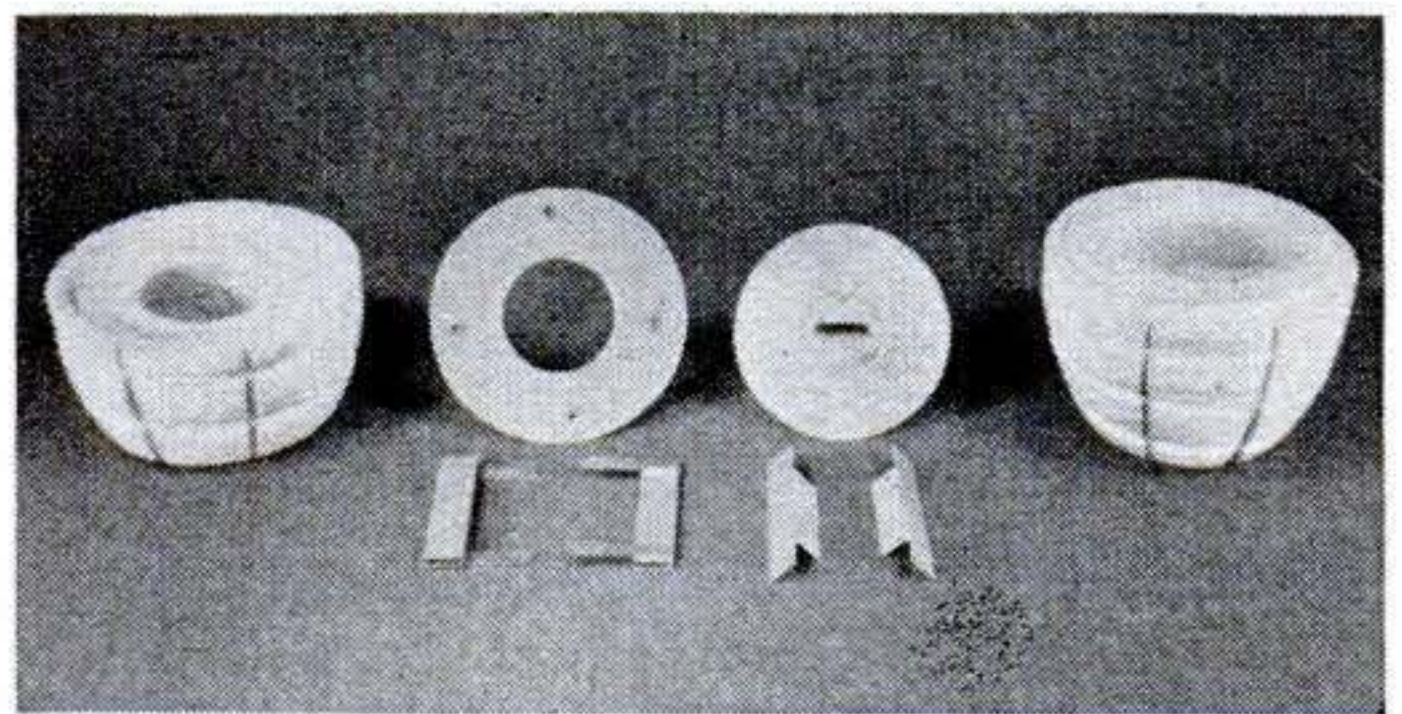

All the parts are pictured above. In the left foreground are the two halves of the chute.

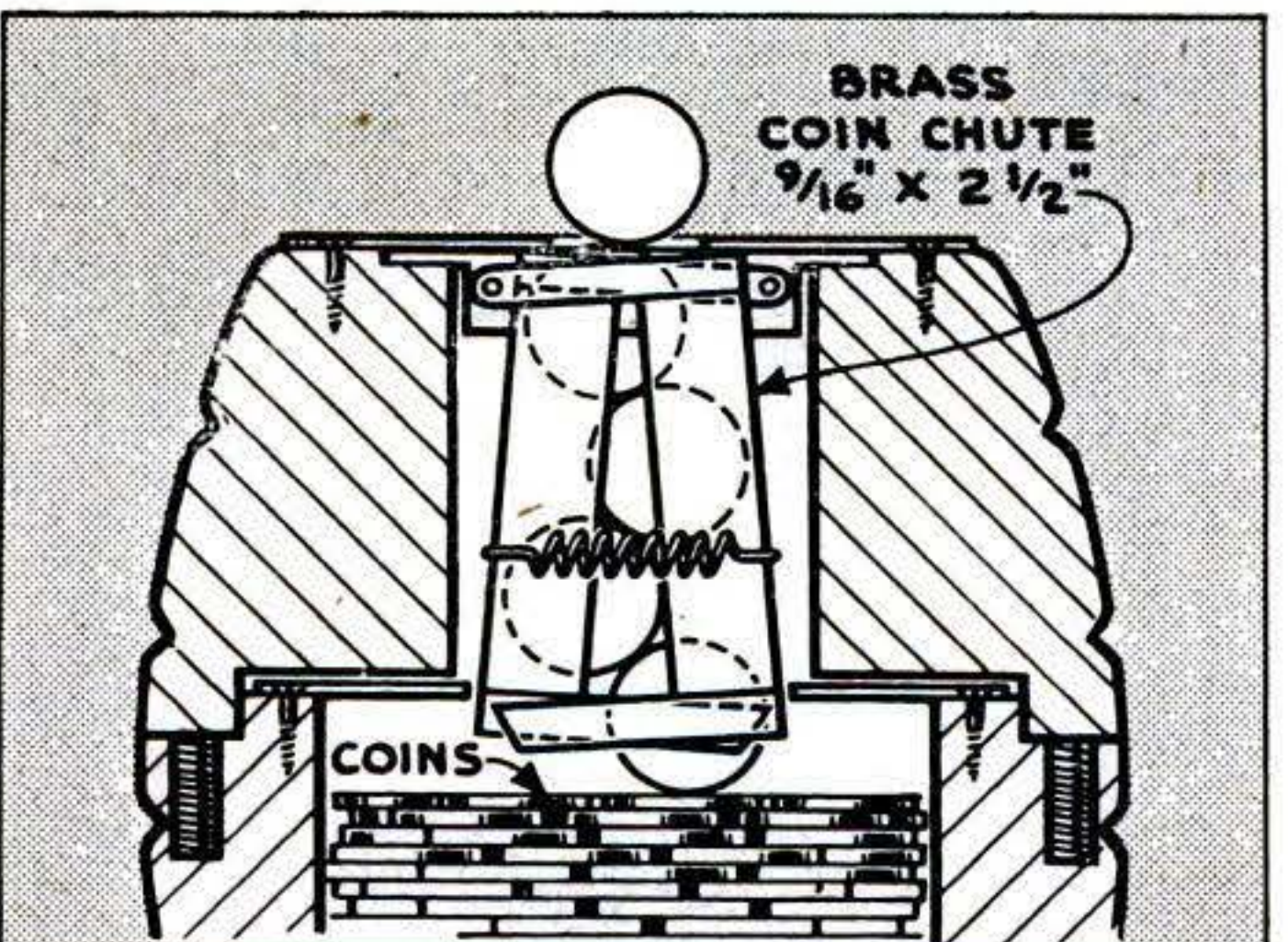

a rasp and drill $3/16$ " holes in the lower half for two springs. Form the coin chute from two $1\frac{1}{8}$ " by $2\frac{1}{2}$ " pieces of 20-gauge brass. Bend each lengthwise to a U-shape so as to form an opening just wide and long enough to take a nickel when the two pieces are placed edge to edge.

Examination of the drawings will show that the chute halves are pivoted at the upper end, a small spring holding them together at the lower. Make two $3/16$ " by $1\frac{3}{8}$ " hinge bars from $1/16$ " brass, and solder one bar to the side of each chute half at the upper end. Solder $1/16$ " by $1/4$ " by $1\frac{1}{2}$ " lock bars to corresponding sides of each chute half at the lower end. Note that each lock bar is filed at an angle at the outer end.

Two brass angles support this assembly, the chute halves being hinged on $1/16$ " screws fitted with small bushings. Attach

the angles to the upper half of the bank with flathead wood screws.

Cut the inside locking ring from sheet copper and fasten it to the lower half of the bank with flathead wood screws. You should now be able to snap the two halves together. If the lock bars fail to snap into place, you can probably remedy the difficulty by placing a cardboard ring under the locking ring to raise it slightly. If the bank halves are too loose, raise the angle plates slightly with cardboard shims. At this point, you can unlatch the mechanism with a small, thin screwdriver.

In the top plate, drill and file a coin slot that will just pass a nickel, being careful to locate it directly over the chute. Attach the plate with flathead screws, countersinking the heads. Then fill in with solder and smooth with emery paper.

Repeater Rubber-Band Gun Gets "Big Game"

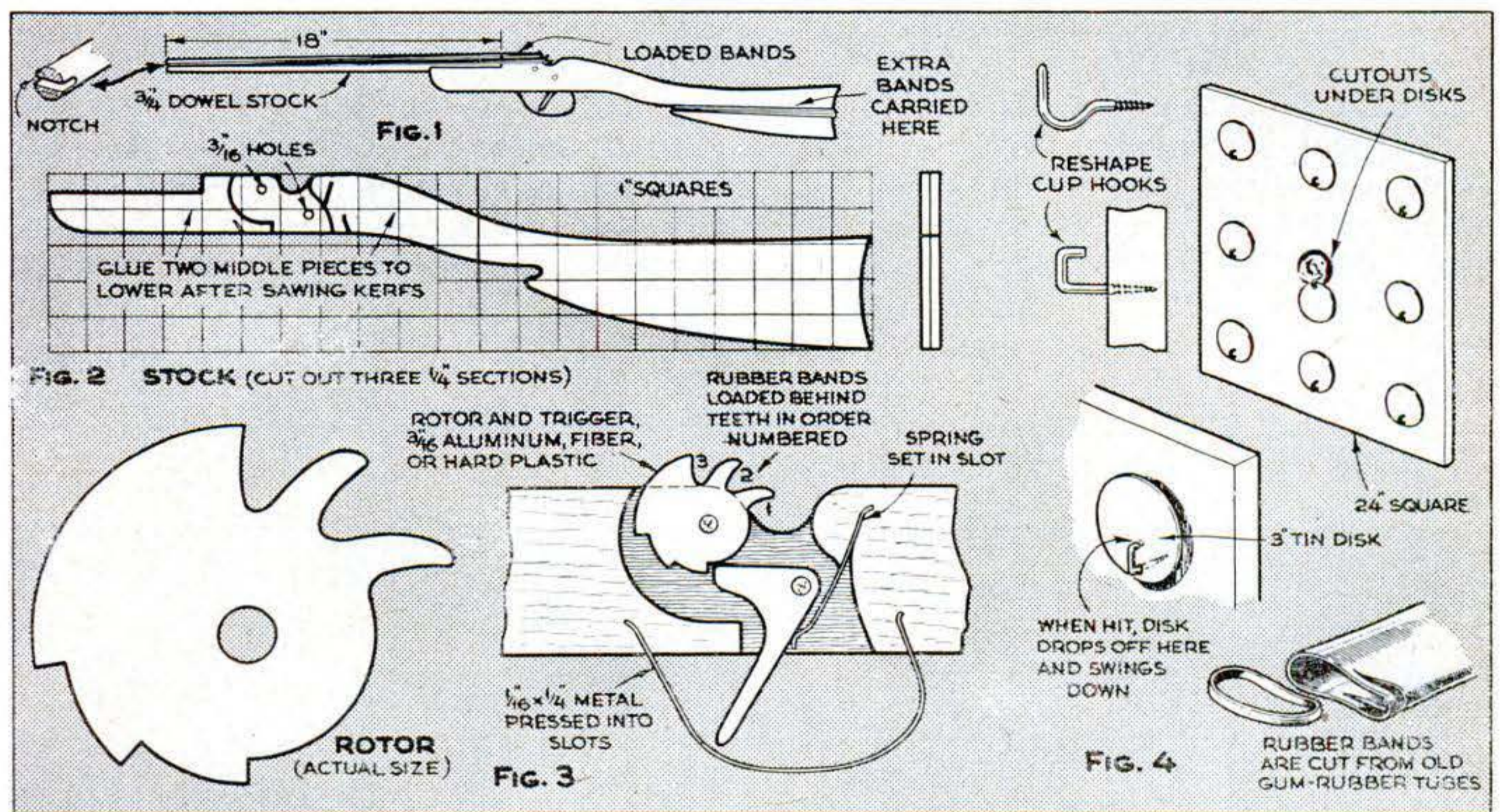

HERE'S a rubber-band gun that looks like a gun, cocks with a click, and shoots three bands one after another on one loading. By making several of these guns and a target panel, on which pictures of big-game animals are revealed when the flying bands knock aside covering disks, you will have an interesting indoor game.

Lay out the pattern of the stock on three sheets of $1/4$ " plywood bradded together. Then drill the two $3/16$ " holes and saw the stock to shape. Now separate the three sections of the stock. Cut away part of the

middle one to accommodate the trigger and rotor. Also make saw kerfs to take the trigger spring and guard.

Glue the two pieces of the middle section in their original position on one of the solid sections. After installing the rotor, trigger, and spring, put the other section on temporarily to see that everything works. If it does, glue this section in position. Notch the back 4" of the barrel to fit the stock and attach with two $1\frac{1}{2}$ " countersunk wood screws after gluing. When you use the gun, squeeze the trigger slowly.—R. R. COLE.

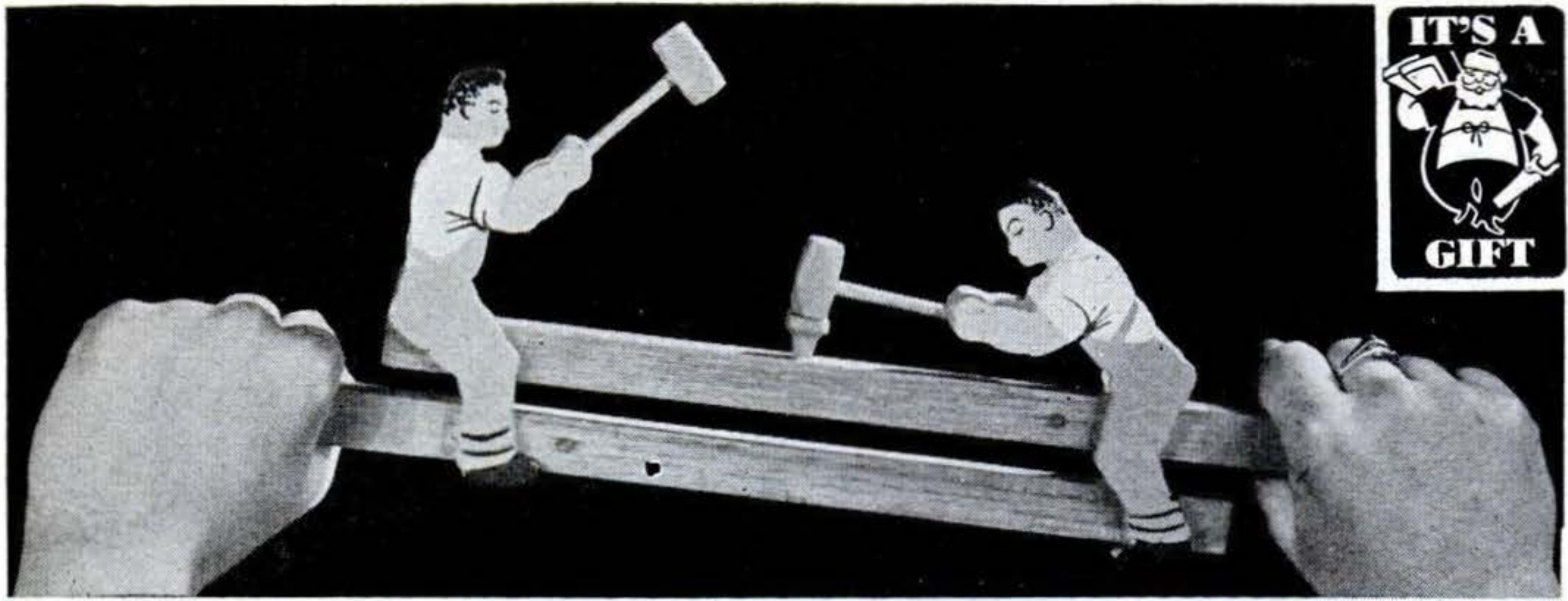

Youngsters who like action in their toys will enjoy making these tireless spike drivers work.

Toy Workmen Drive Spike

MECHANICAL toys seem so much a product of our own century that it may be hard to believe this one originated around 300 years ago. In the tavern scene reproduced on page 129, Jan Havicksz Steen depicted an ingenious plaything held firmly in the hands of its young owner. You can make a copy from pine and plywood.

The two handles are made of $\frac{1}{2}$ " wood with holes spotted in the same position on both pieces. Each of the figures is made of $\frac{1}{4}$ " plywood sides glued around the $\frac{1}{2}$ " center sections used for head and body and hands. If you have access to a power jig-saw, make all four sidepieces at one time.

Assemble the figures with glue and sand and shellac them carefully. Drill $\frac{5}{32}$ " holes into the center of the hands to hold the hammer handles, and also drill scant $\frac{3}{16}$ " holes through the legs as shown. Hammer heads and the spike are shaped from $\frac{1}{2}$ " stock. Dowels used for the hammer handles should be cut a trifle long initially so that they can be trimmed as needed until both hammers hit the spike squarely.

Give all parts a final sanding. Apply a coat of shellac and allow it to dry before assembling the moving parts. Paint in the detail and color as indicated in the photo on page 129.—JAMES J. O'HARA.

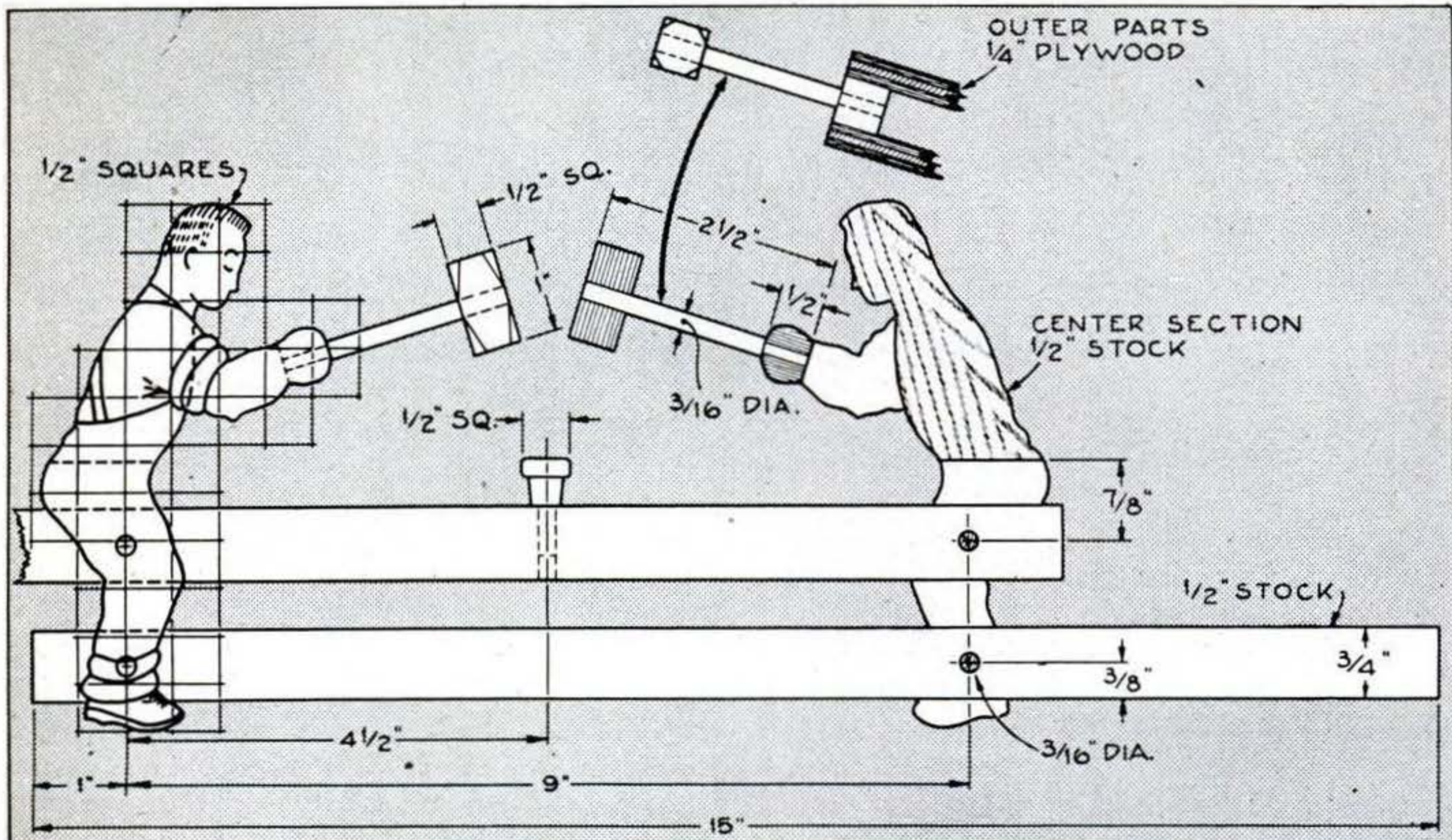

WHAT'S YOUR I.Q.?

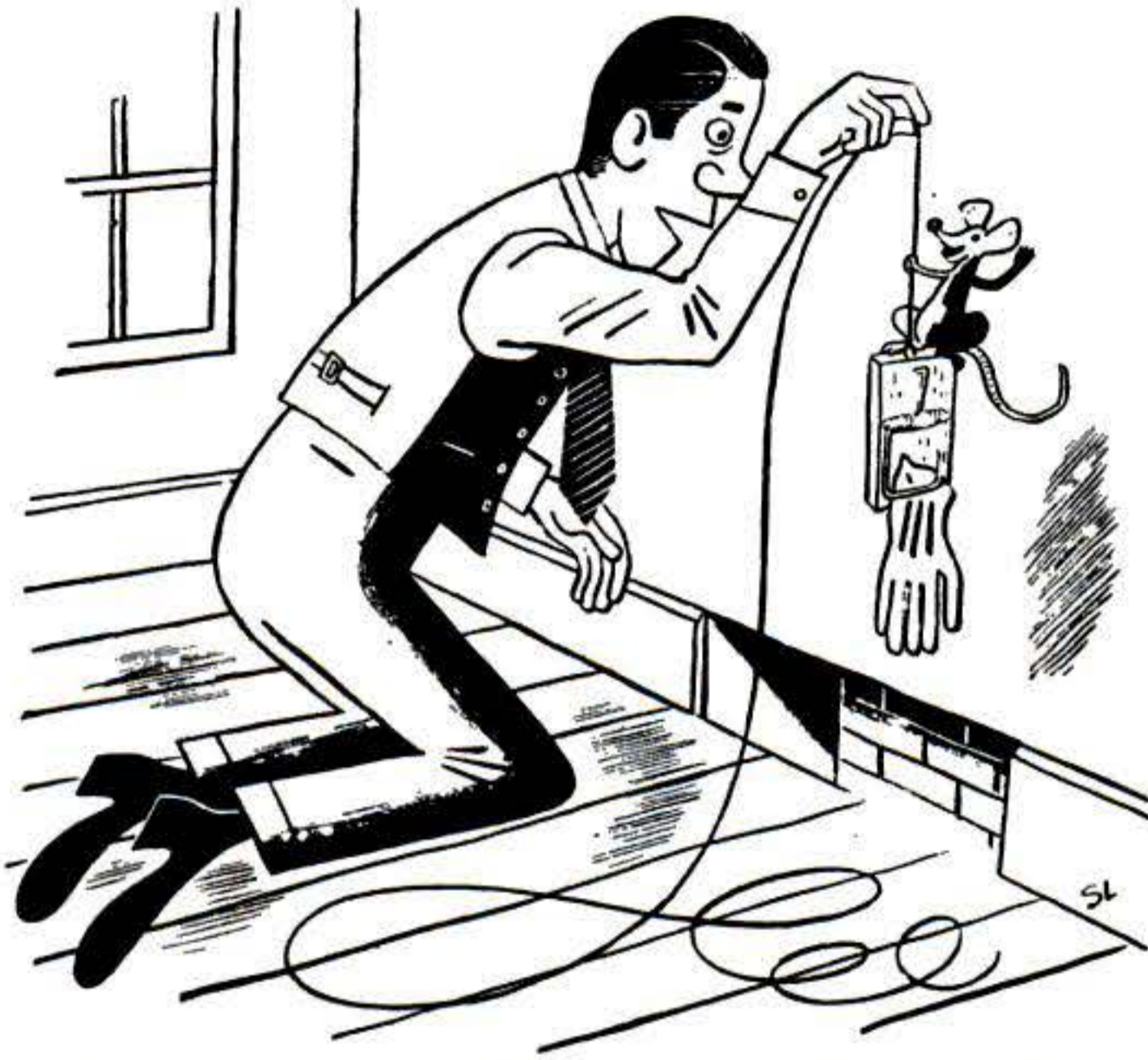

Mousetrap Garners Gauntlet.

While insulating my attic, I dropped a work glove into a partition. It came out promptly when I sent a string-suspended mousetrap down after it.—HOWARD A. GUNDERSON.



Freezing Holes in Rubber. I can't drill or cut sponge rubber cleanly when it's soft, but by soaking it in water and then freezing it in dry ice, I get a crisp, workable material. The drill or saw must also be kept slightly chilled.—RONALD J. MCKENZIE.



To find the fuse for an outlet with the least stair climbing, I plugged in a nonself-starting electric clock synchronized with my watch, and then downstairs pulled one fuse a minute. The time on the stopped clock told me which it was.—DONALD STEWARD.

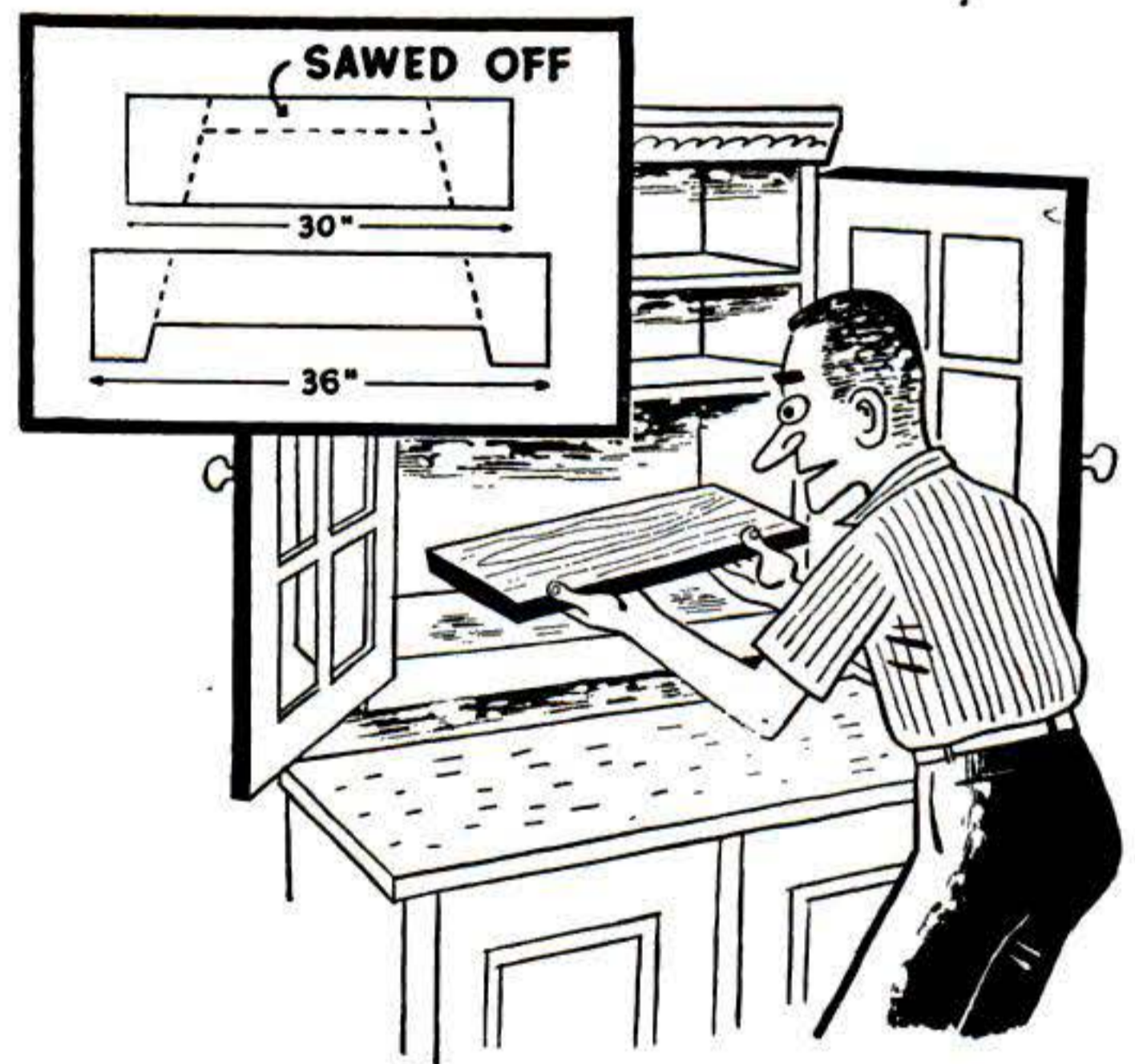

Saw Stretches Shelf. And it needed stretching, too, because the cabinet to be fitted measured 36" while the longest board I had was only 30". To make it bigger I cut it down as shown. The center piece moves back, the edge is sawed off, and I have an indented shelf.—A. RICHARD FISKE.

Have you pulled off a smart one lately? We will pay for acceptable contributions showing ingenious solutions of problems in the home, shop, garage, or camp. It doesn't matter if it's wacky—if it works.

Wrought-Iron Tables Have Glass Tops

By **John P. Arnold**

A GLASS-TOPPED wrought-iron table in either of the two designs shown here will quickly make a place for itself in the household. Impervious to weather in a terrace, porch, or garden spot, it's equally at home indoors as a serving table, a plant stand, or simply a side table. When not needed, it can be disassembled by removing two bolts and compactly stowed away.

Dimensions on the drawing are for a 24" by 32" glass top, but the length can be altered to suit. Whatever size you decide on, get the plate-glass top before starting work. Unless you are familiar with glass work, it's best to buy it cut to size with the edges polished. Legs should be not smaller than $\frac{3}{8}$ " square mild steel. You'll also need some flat bar stock for rails and stretchers. Aluminum might be used instead if available.

In making the cross-leg design, it's well to lay out a full-sized plan on paper and mark the half-lap joints from this. Cut the legs to length, lay them on the plan, and transfer the lines of the joint, which can be worked out with hacksaw and file. It should be a good push fit, without looseness. Drill through for the stretcher bolt.

If you prefer the half-round legs, lay out a full-size pattern of the curve and check the work against it frequently while bending it to shape. Form feet on the lower sections by heating red hot and upsetting the metal with a hammer to the form shown in the drawings. Join the two halves of each leg by welding, brazing, or bolting as shown in the drawing. In the latter case, fillets may be formed and gaps filled with iron furnace cement.

Both upper ends of either type of leg are



drilled and tapped. Cross rails are fastened with bolts and notched half their width from the top edge to form half-lap joints with the top stretchers. Notch the latter accurately so that the joint beneath the glass is flush. Bent-up tips on both members, formed as shown below, hold the top from sliding off.

The lower stretcher is drilled and tapped at both ends. If means are available, it can be twisted as in the photo above.

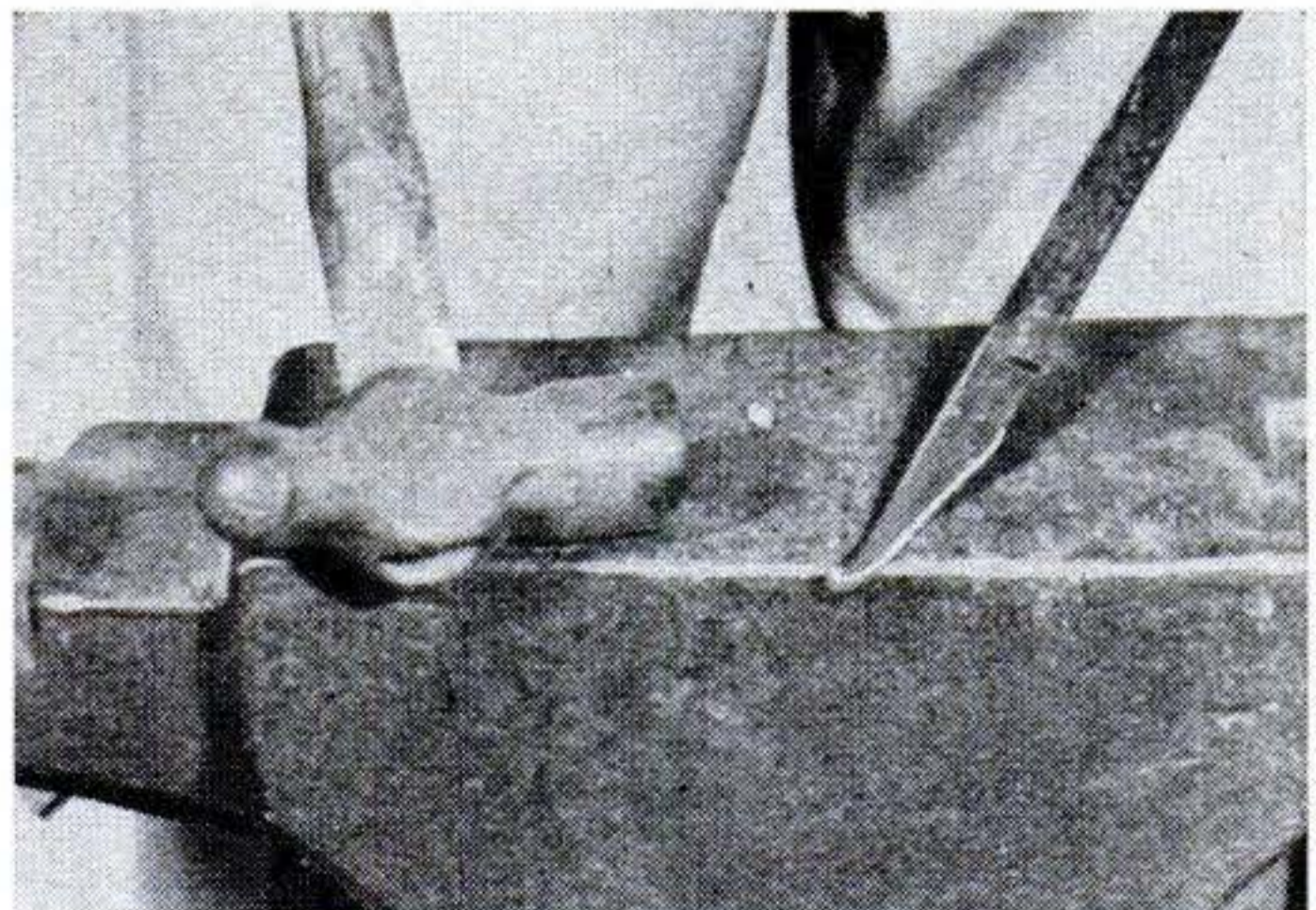

Tip up rail and stretcher ends by hammering to form lips that will keep the top from sliding.

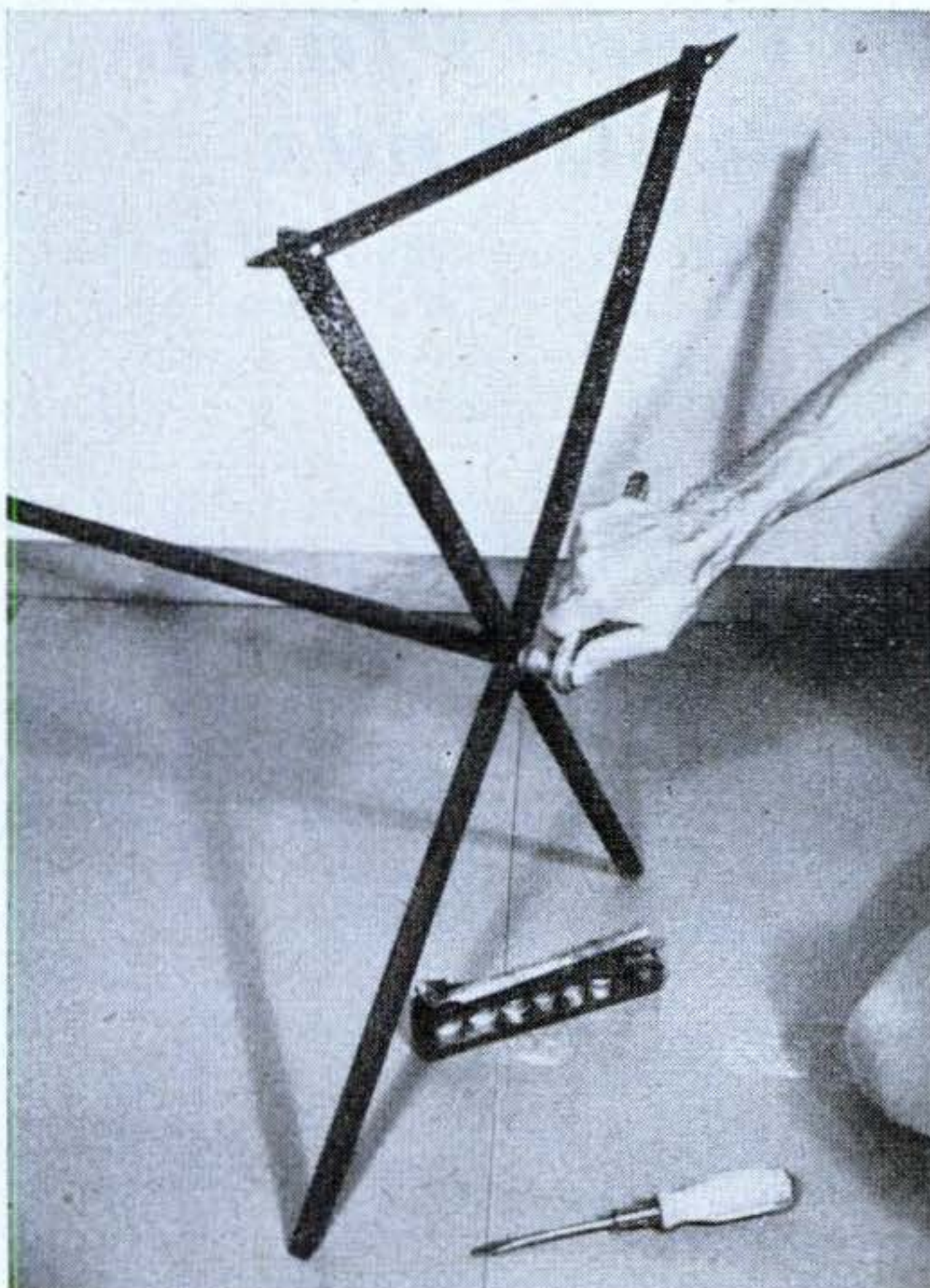
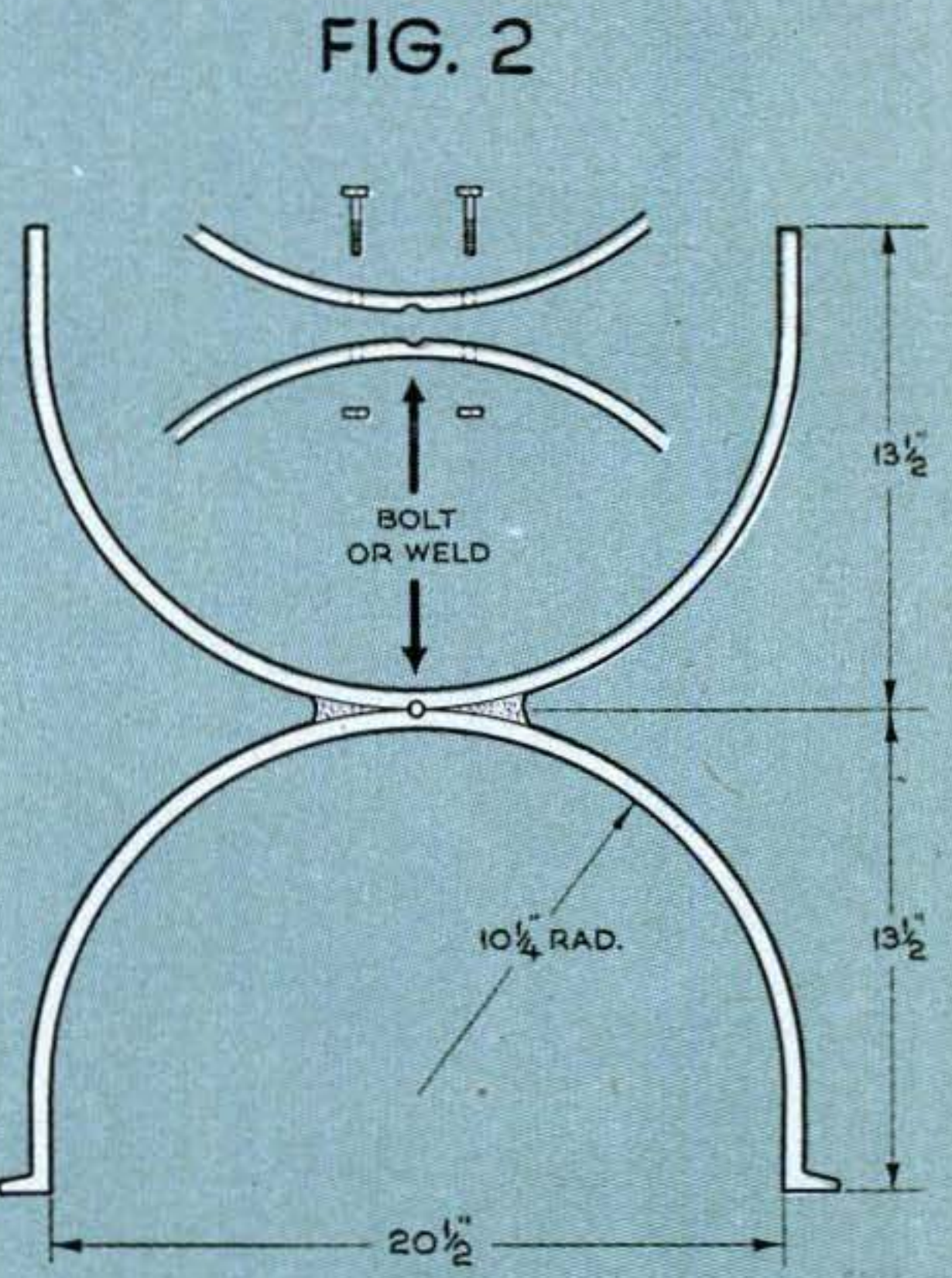
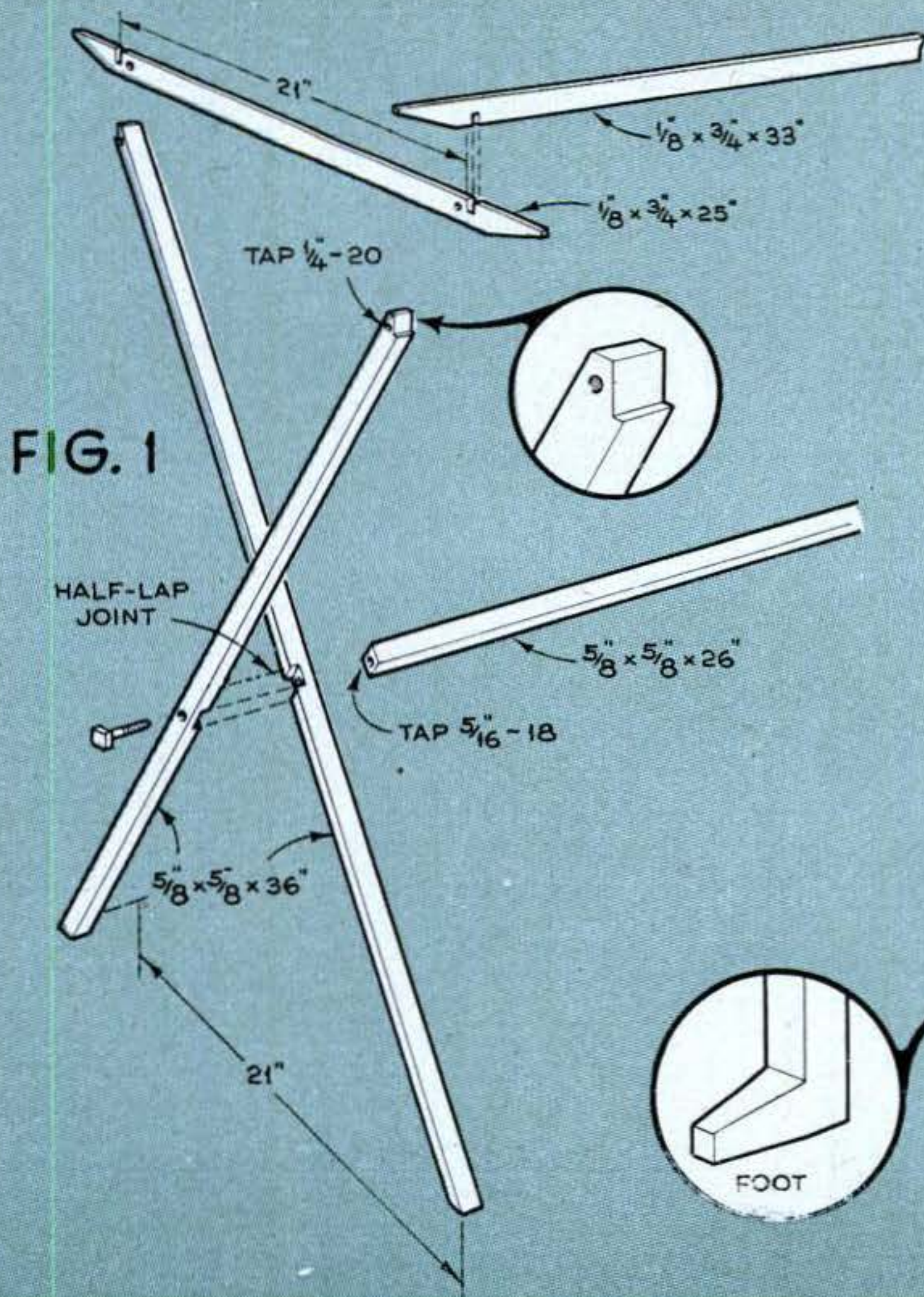

Two bolts hold the top rail. The stretcher is secured with a bolt through the half-lap joint.

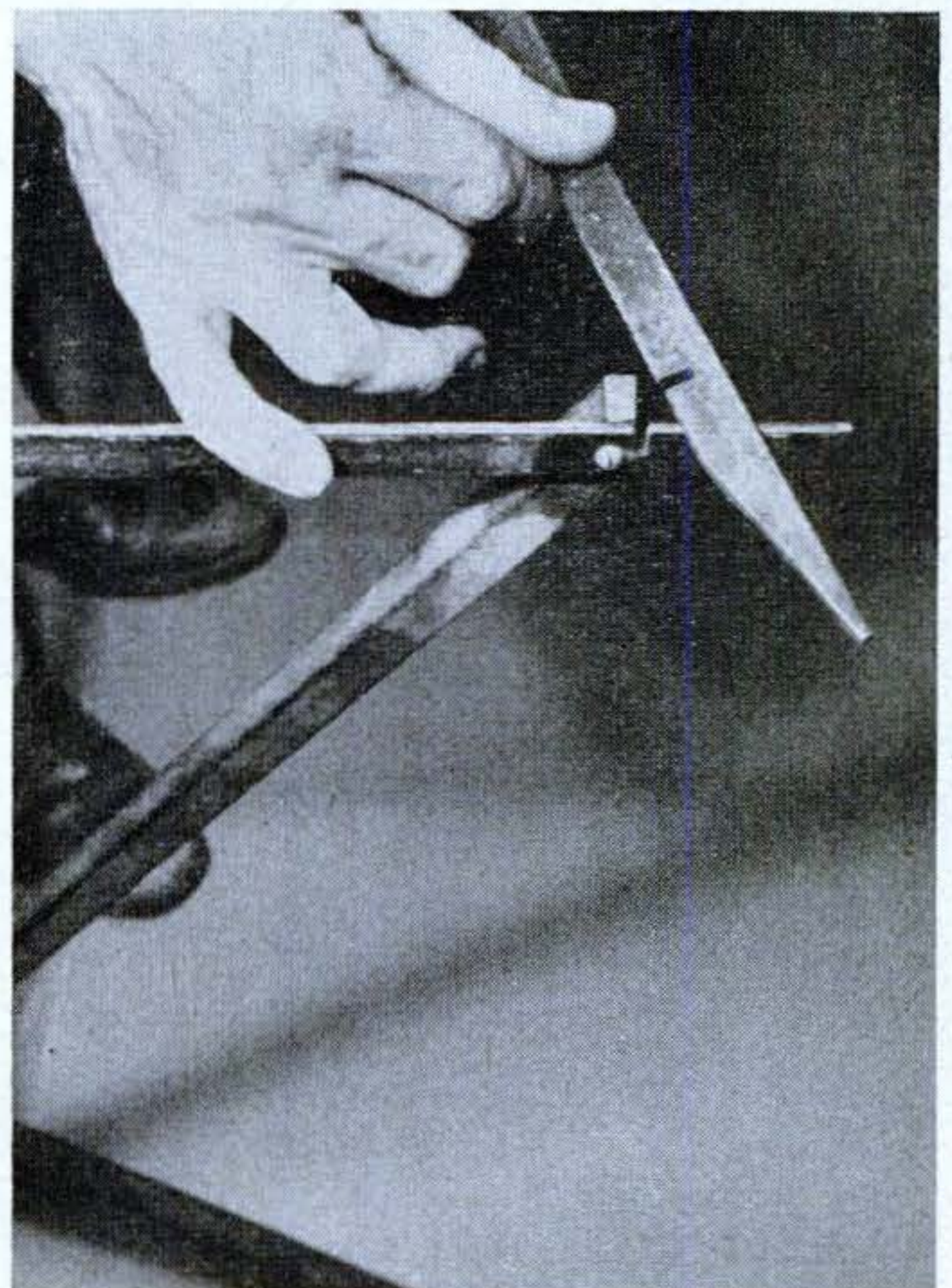

Notch top rails and stretchers accurately to form a flush joint for the glass to rest upon.

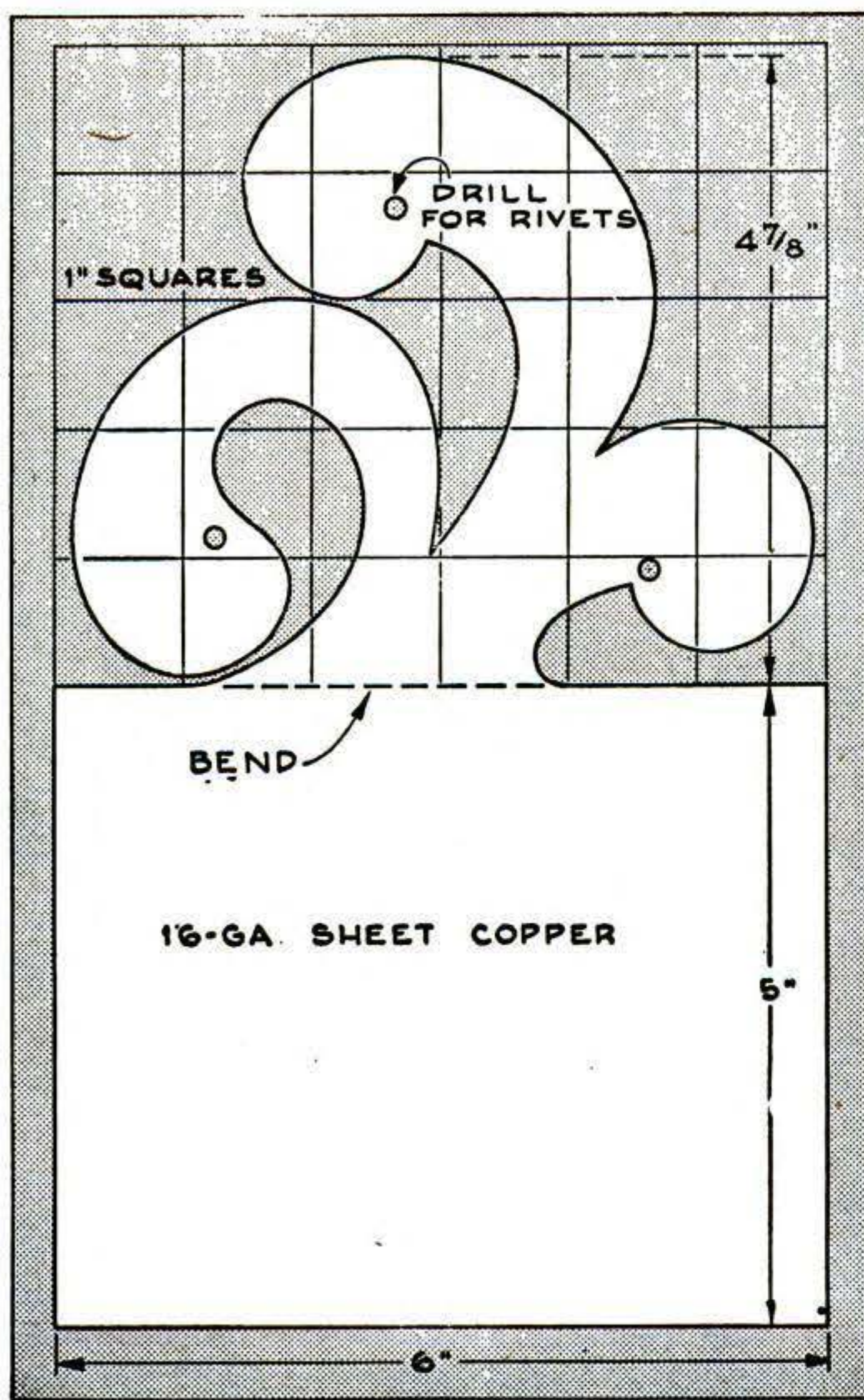
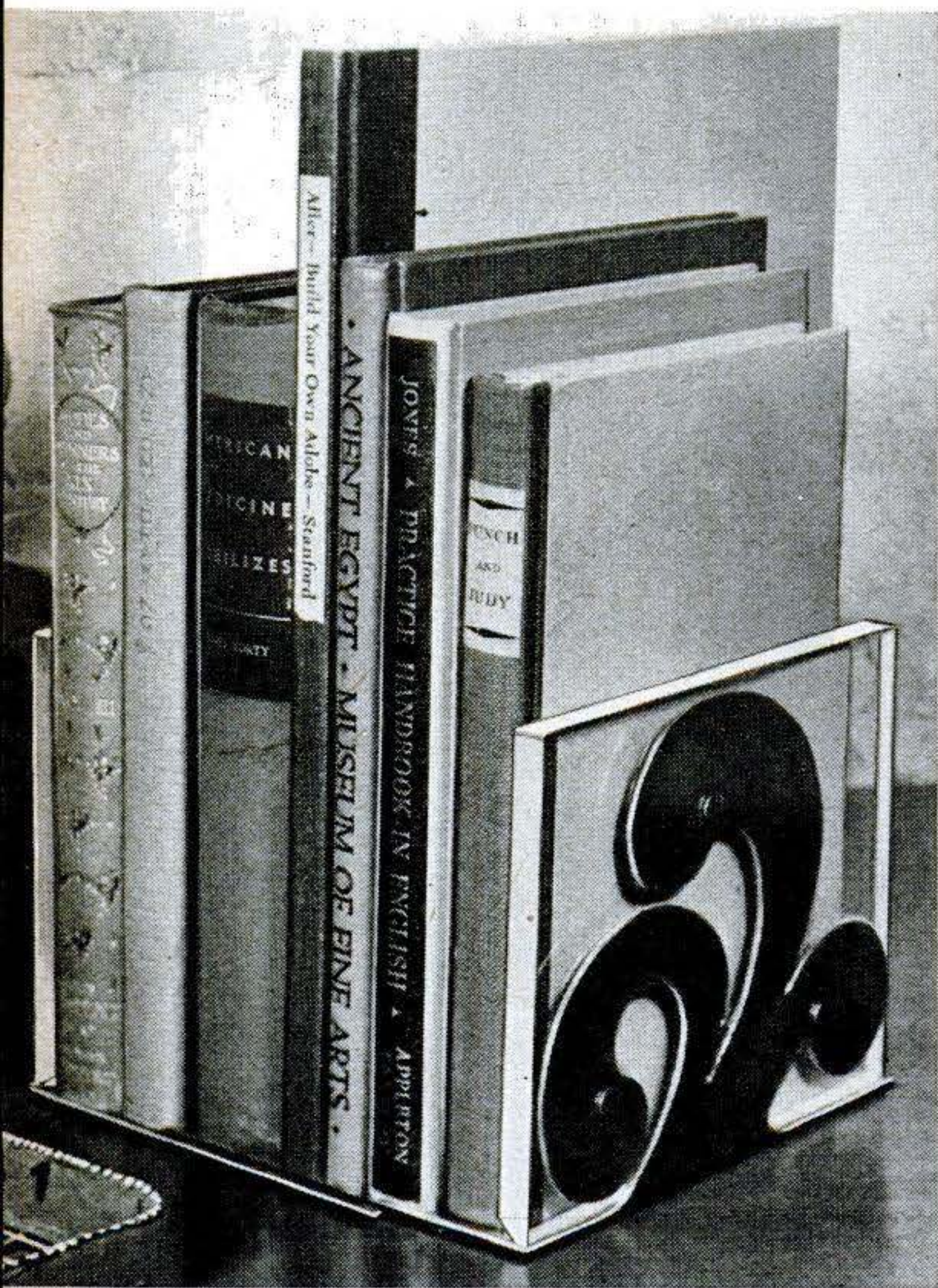

Copper Overlay on Clear Plastic Makes Modern Book Ends

GLEAMING copper and clear plastic are combined in this distinctive pair of book ends. The contrasting materials and simple design make them an appropriate accessory for use with modern furniture. Two 5" by 6" pieces of $\frac{3}{8}$ " clear plastic, two 6" by 10" pieces of 16-gauge sheet copper, and six $\frac{1}{4}$ " tubular copper rivets are the required materials.

After cutting, smooth all the edges of the copper and plastic with a file. There will be less chance of marring the plastic if the

filing is done before removal of the masking paper. If available, a bending brake would be a convenience in bending the copper, but it can easily be done without. Polish the copper, and drill holes in the plastic and copper for the rivets that hold the pieces together.—DORIS ALLER.



Cut the copper to shape on a jigsaw, or if this is not available, a jeweler's saw may be used.

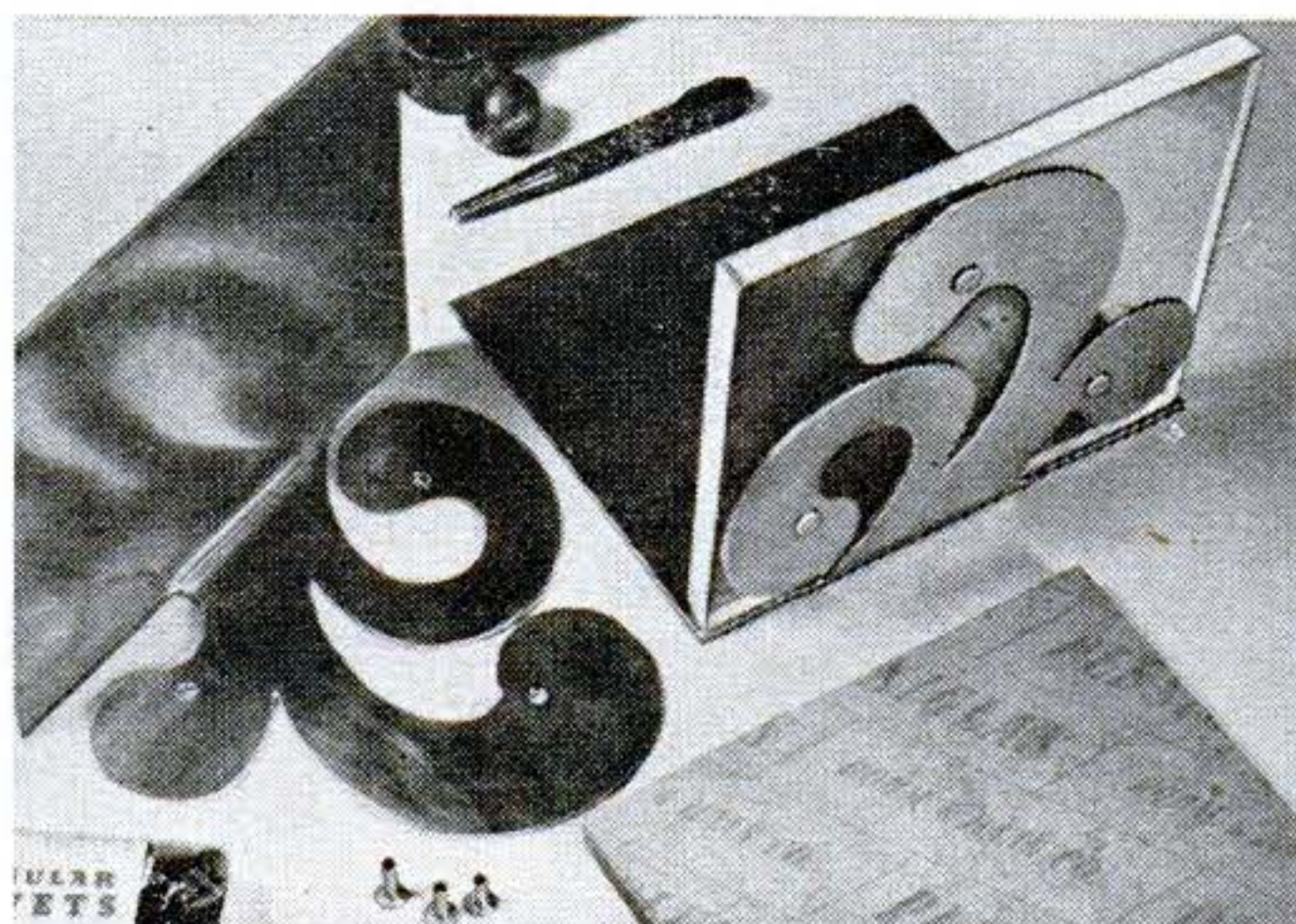

Tubular copper rivets are used to attach the copper overlay to the piece of $\frac{3}{8}$ " clear plastic.

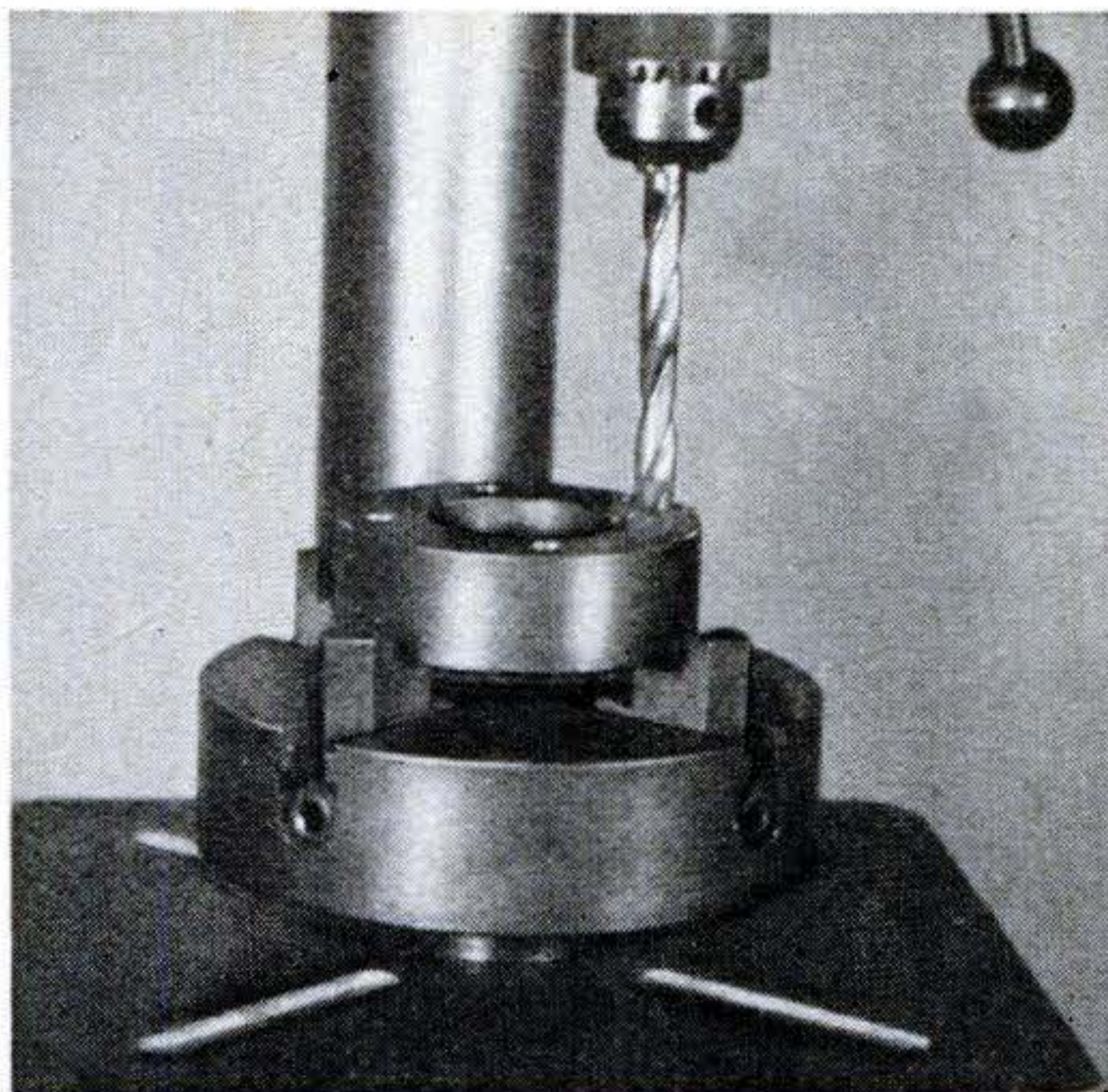

Chucked on the table, lathe work can be drilled with holes accurately parallel to the turning axis.

Lathe Chuck Doubles as Drill Vise

WITH this adapter your lathe chucks and faceplates can be used on the drill-press table, often without disturbing the way the work is chucked or clamped. Lathe work can be transferred to the press with assurance that all drilled holes will be parallel to each other and to the axis of turning, and at exactly 90 deg. to the face. Any desired drilling location can be selected by a combination of table swing and rotation of the chuck or faceplate.

For accurate results the center hole of the table must be bored round and free of taper.

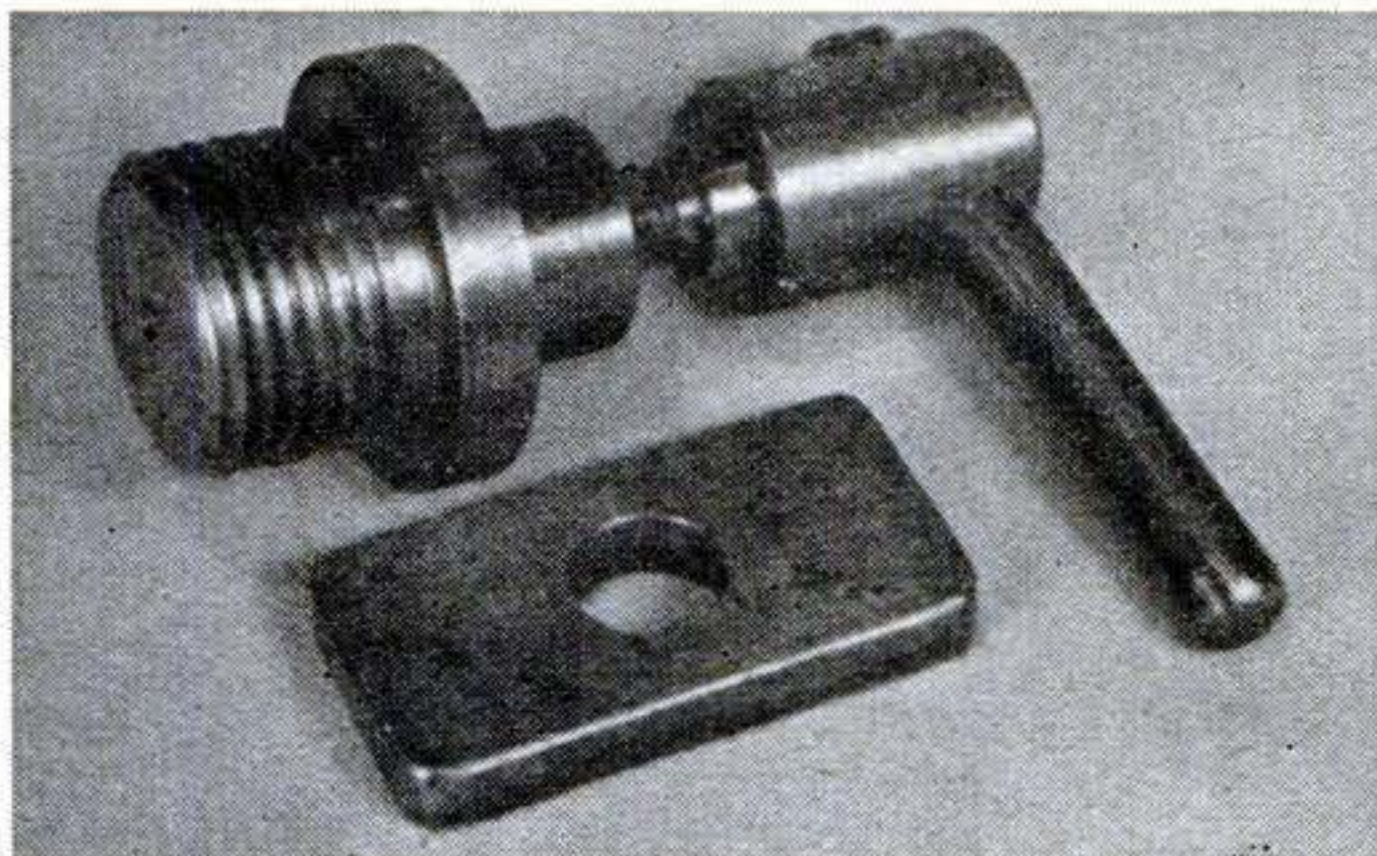

These three parts are all you need to mount lathe chucks or faceplates on the drill press.

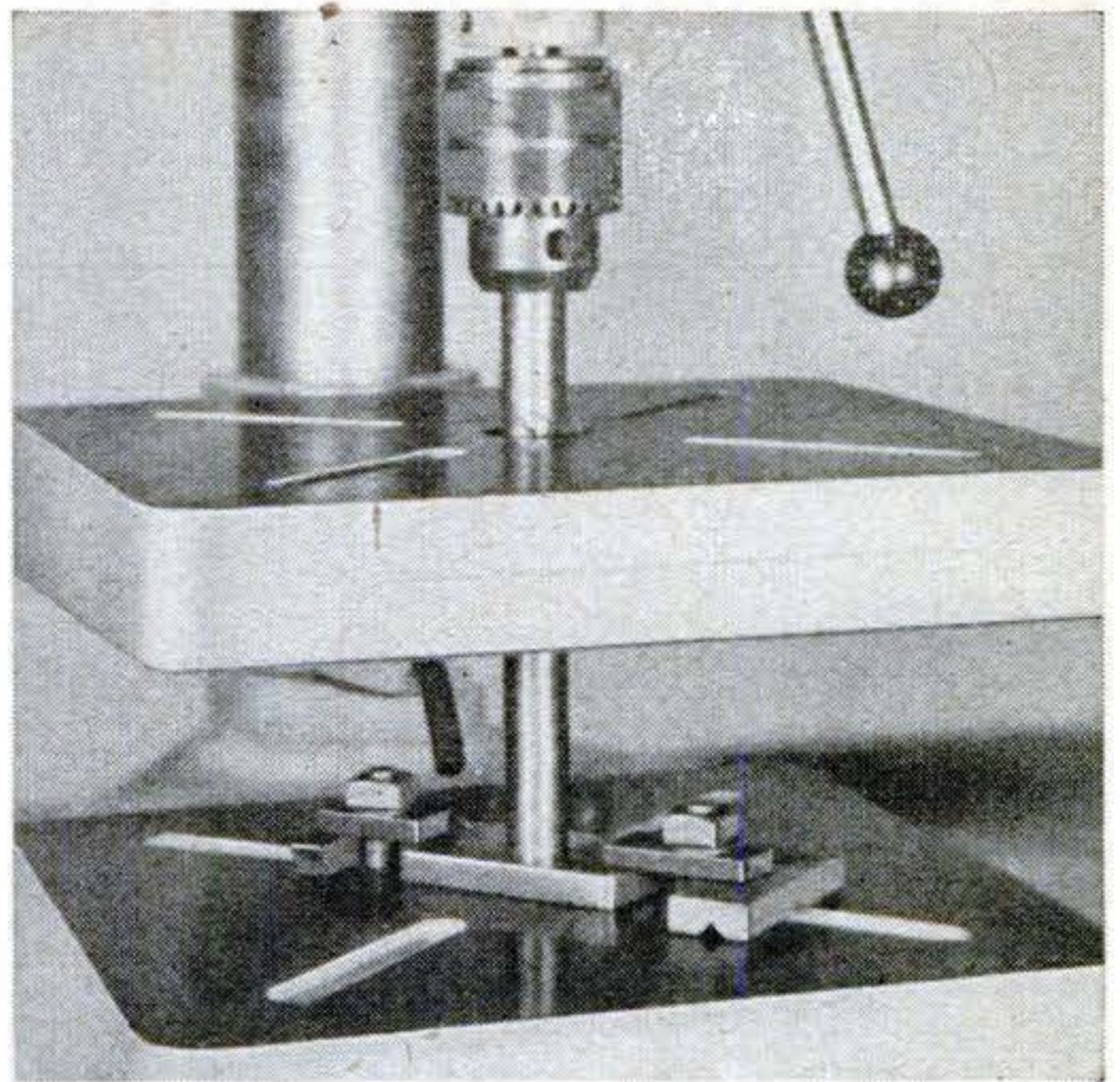

This boring setup enlarges the center hole of the drill-press table. Note the lower bearing.

The setup shown above does this nicely. I used 11/16" bar turned down to 1/2" at one end for the drill-press chuck, and cross-drilled twice for a 1/4" lathe bit and setscrew. A hole in a plate bolted to the base table serves as a lower bearing for the boring bar. I enlarged the center hole to 1 1/8", taking a series of light cuts at low speed.

The adapter parts are straightforward machining jobs. Check the dimensions against your drill-press table, and thread the spindle nose to fit your chucks and faceplates. Turn the spindle nose so that it will make a free push fit in the bored-out table hole. Be sure there's at least 1/16" between the spindle end and locking plate.

Chips can be kept out of a chuck by placing a paper "apron" on the work and drilling through it. On through holes, damage to the chuck or faceplate may be prevented by the use of a pad of scrap metal under the work.—JOHN A. BATES.

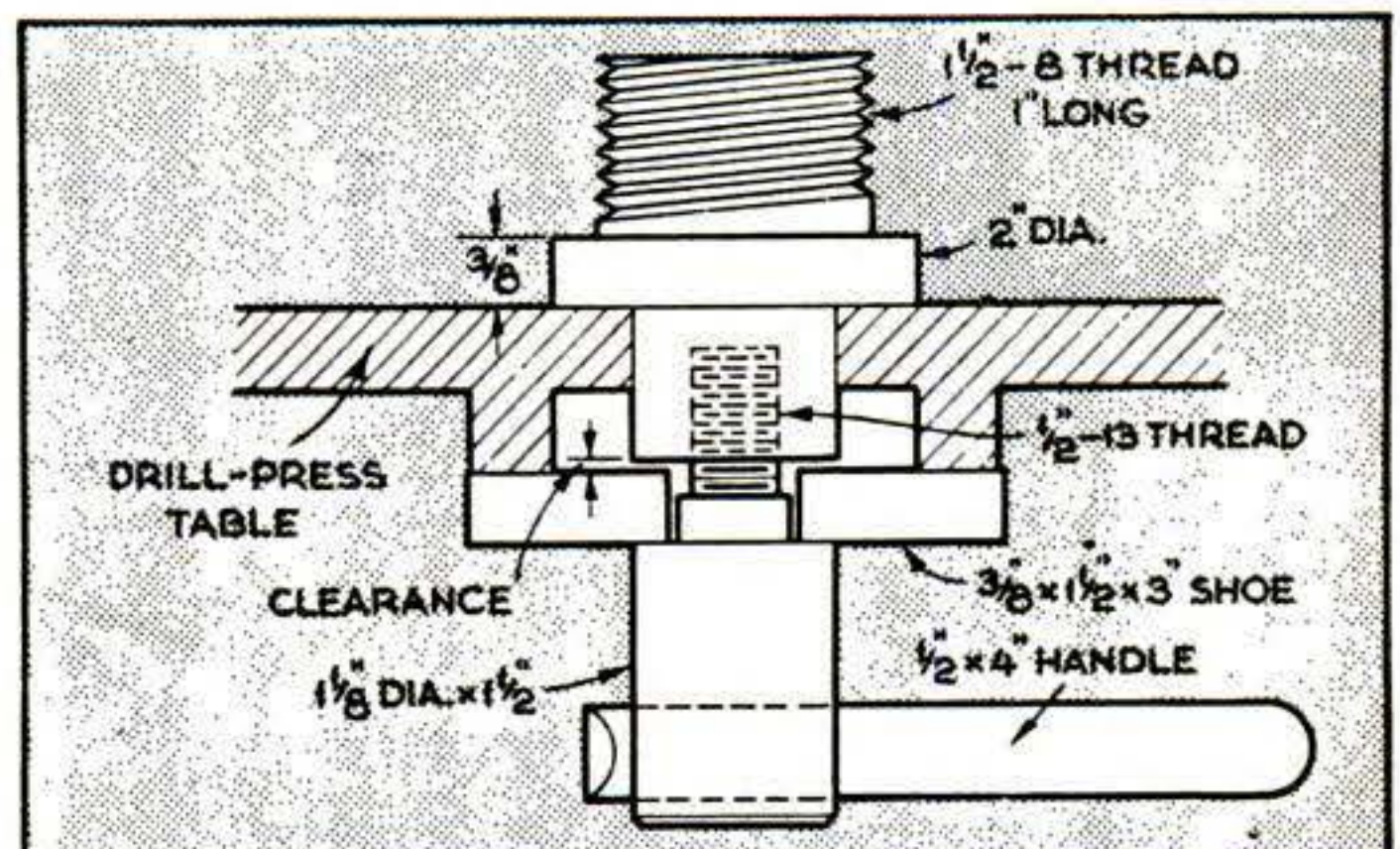

No critical dimensions are involved, and ordinary cold-rolled steel will do as material.



NEW SHOP IDEAS

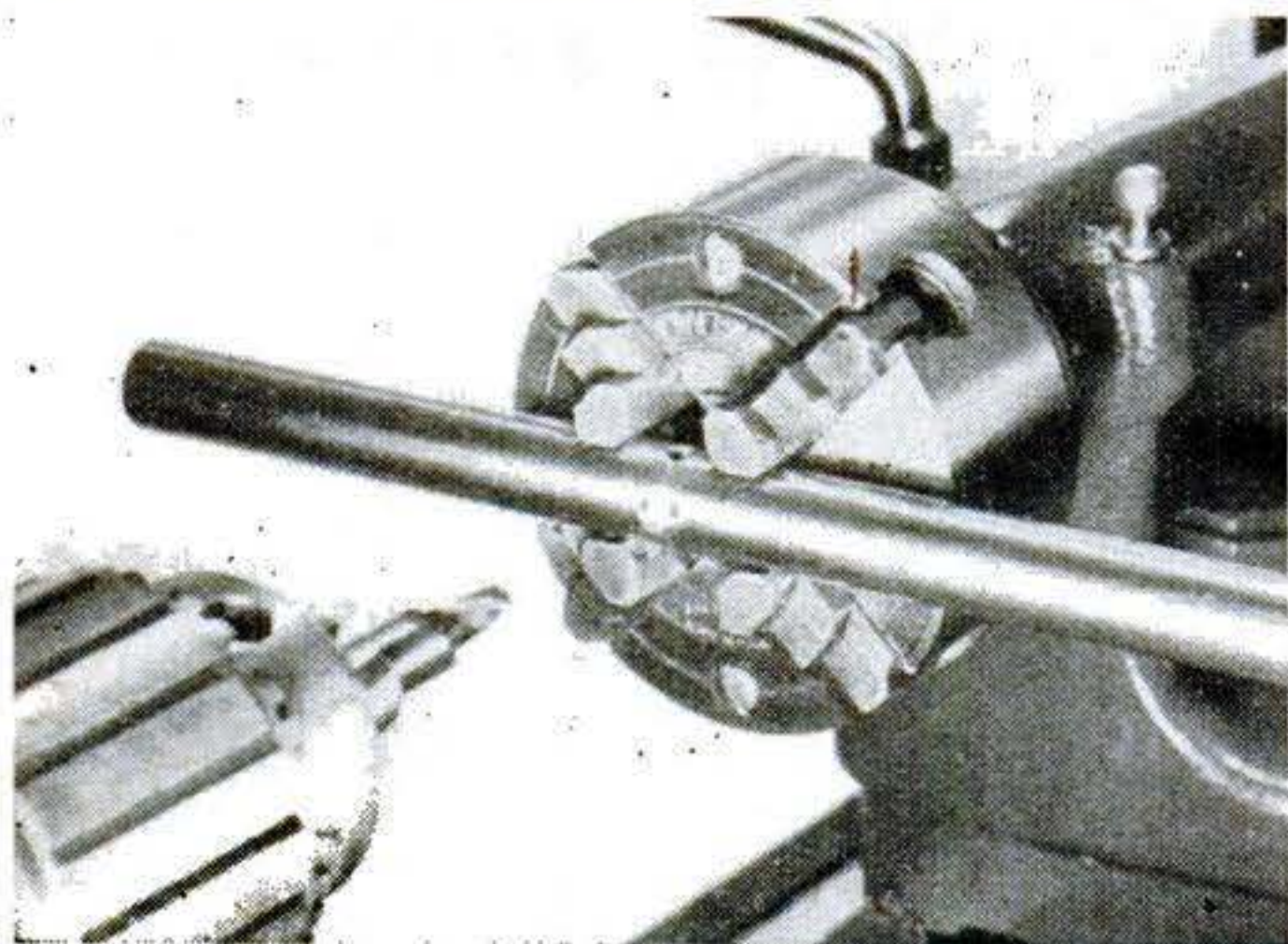

Vise for End Milling. I tried counterboring a hole in a boring bar by holding it on the drill press in V-blocks, but the bit caught on a transverse hole tapped for a setscrew and would not stay true. Finally I gripped the bar in the four-jaw chuck on the lathe tailstock and fed it against an end mill, with good results.—H. L. PHILLIPS.

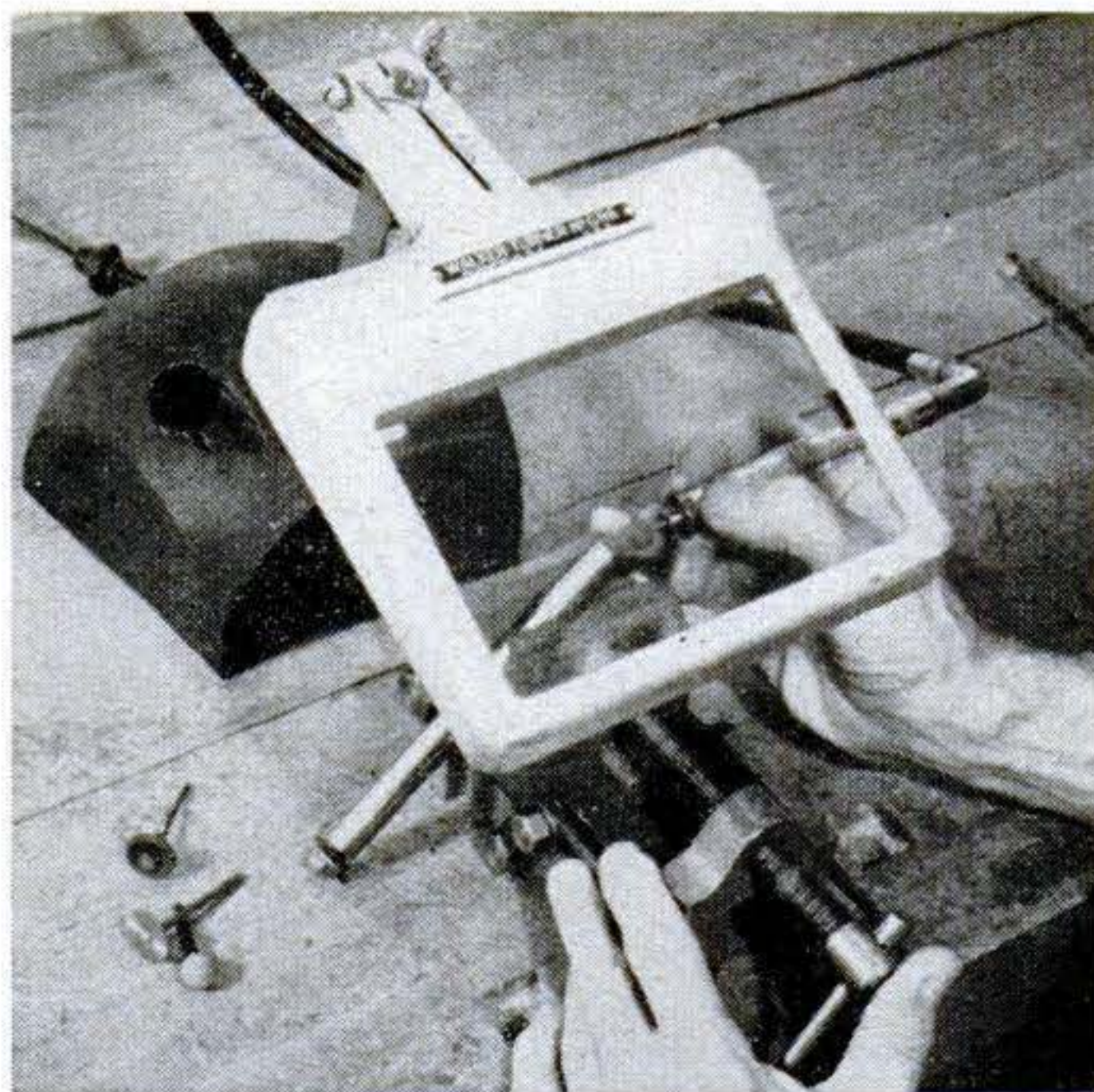

Shield Illuminates Fine Work. If you have a grinder with an illuminated safety shield, you'll find this ideal for delicate work such as assembly, fine hand grinding, and carving, for it gives needed light and protects the eyes. The one above, mounted on a heavy base, is detachable for replacement on the grinder.—J. P. ARNOLD.

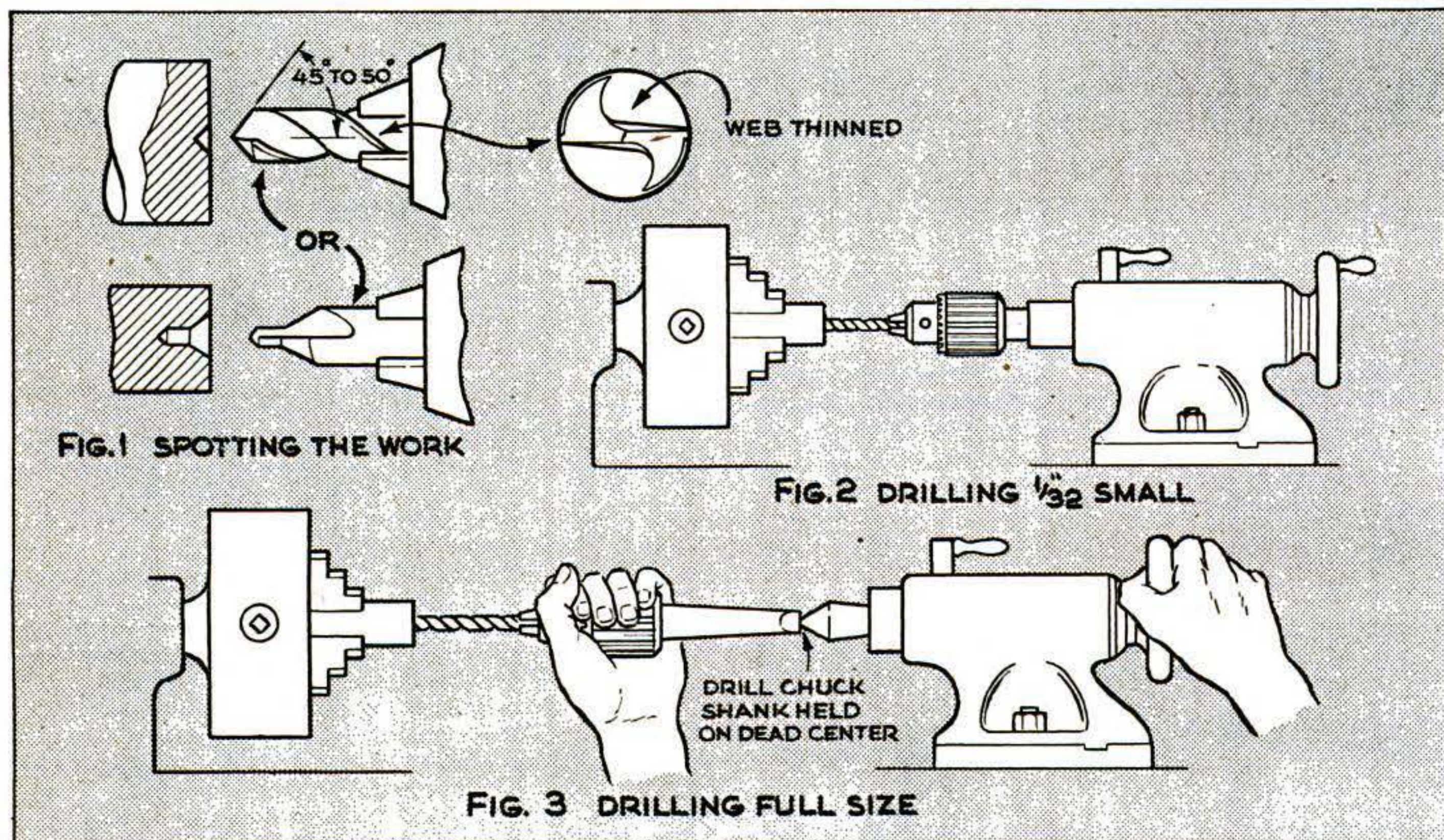

Drill Used as Floating Reamer. Reaming an undersized hole to finish size with a drill is often disappointing. If the drill is rigidly mounted, a slight bend or misalignment will create a bell-mouthed or tapered hole. However, steel sleeves have been drilled with true holes up to 1/2" in

diameter by a routine method as follows: The hole is spotted with a stubby drill reground as shown or with a centerdrill (Fig. 1). It is drilled 1/32" small as in Fig. 2. The reaming drill is mounted in a taper-shank chuck held as in Fig. 3. Floating action permits it to center itself perfectly.

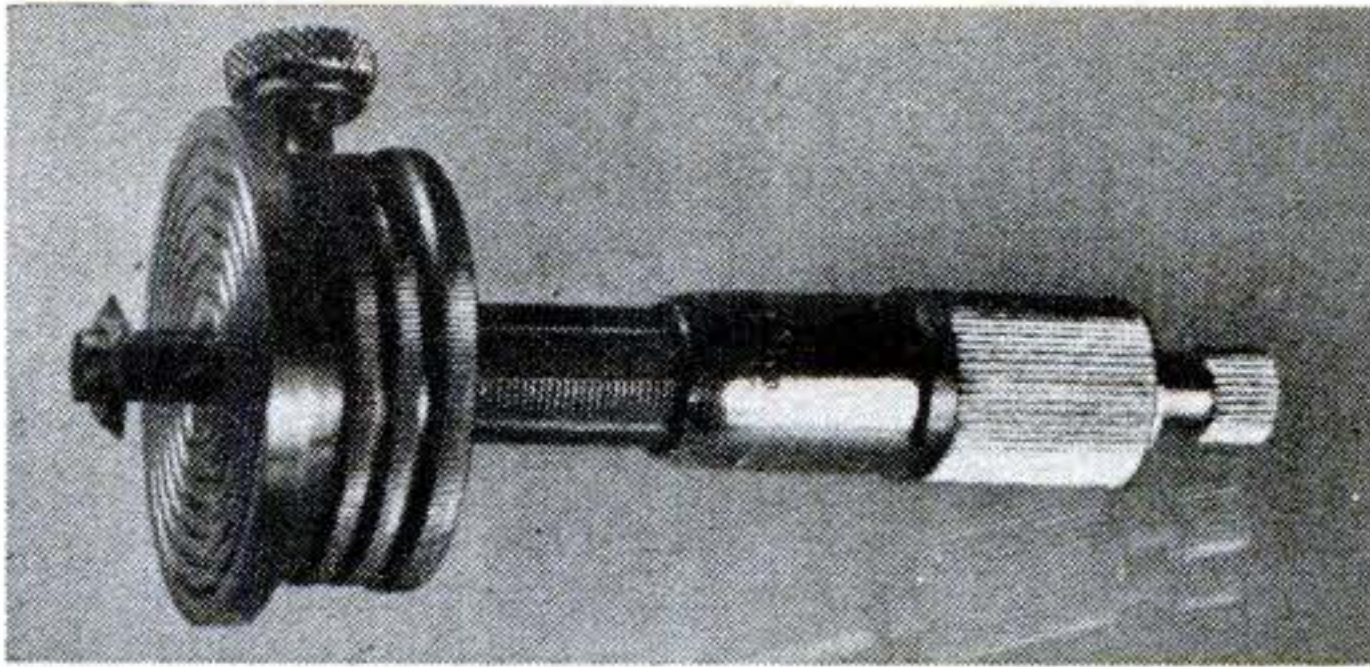

Scriber Has Mike Adjustment.

An inexpensive micrometer with the frame cut off forms the heart of this scriber and depth gauge. The spindle was annealed, both ends centerdrilled in the lathe steady rest, and the barrel mounted between centers. With a sharp tool and very light cuts it was turned true along $\frac{3}{8}$ " of its length.

The head was rough-turned, drilled $\frac{1}{32}$ " undersize, knurled, and then reversed in the

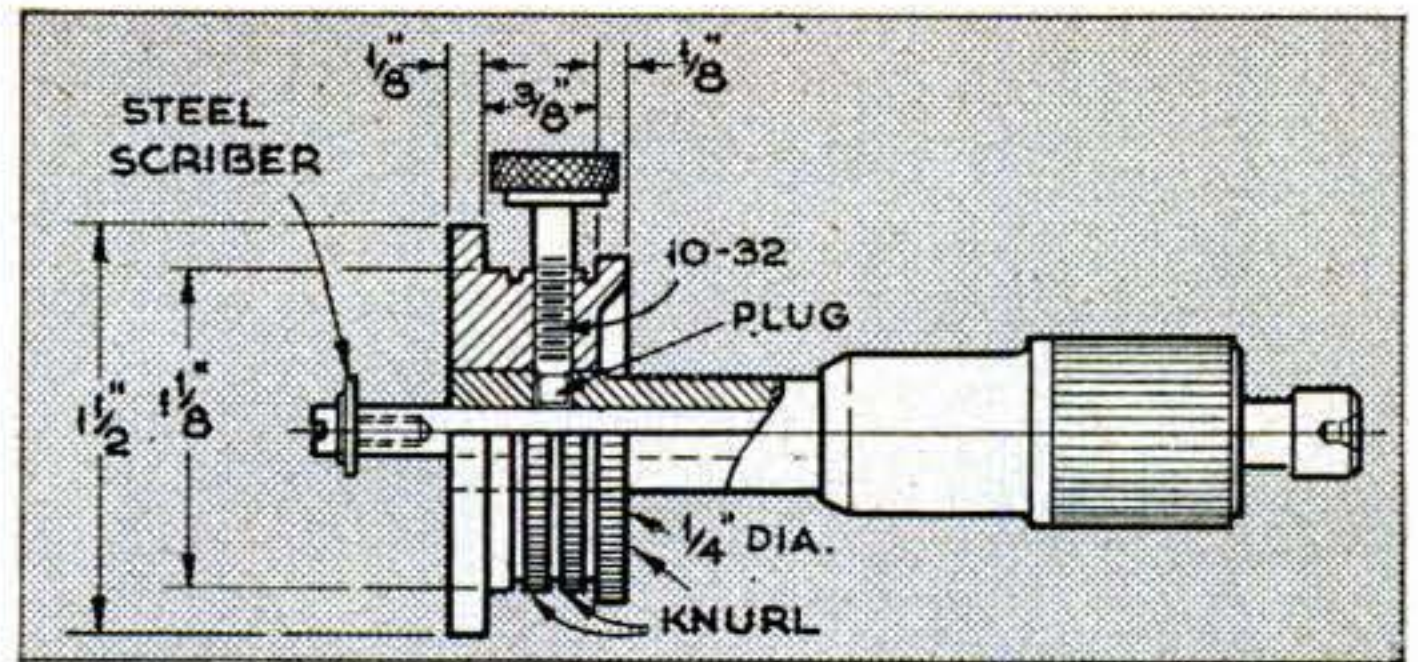

chuck to finish-turn the face and bore the hole a light press fit for the barrel. This was pressed in and a hole tapped for a setscrew and a hardwood plug that lock the spindle. The spindle was lapped flush with the face at the 1.000" reading, tapped, and fitted with a spring-steel scriber. Settings are the difference between 1.000" and the reading. For depth measurements, add the scriber and screw thickness.—PAUL T. CLEMENTI.

Tailstock Wipers Clean Ways.

Chips trapped under the tailstock when it's loosened and reclamped may throw it out of alignment or embed themselves in the ways. It's a simple matter to equip the tailstock with wipers like those used on carriages. A band of $\frac{1}{16}$ " by $\frac{1}{2}$ " stock is shaped to the casting and drilled near each end. Spot the band about $\frac{1}{16}$ " above the ways, transfer the holes, and tap 6-32. Attach the piece with two screws and a strip of felt low enough to ride on the ways. Soak the felt with oil.—RICHARD HANSCOM.

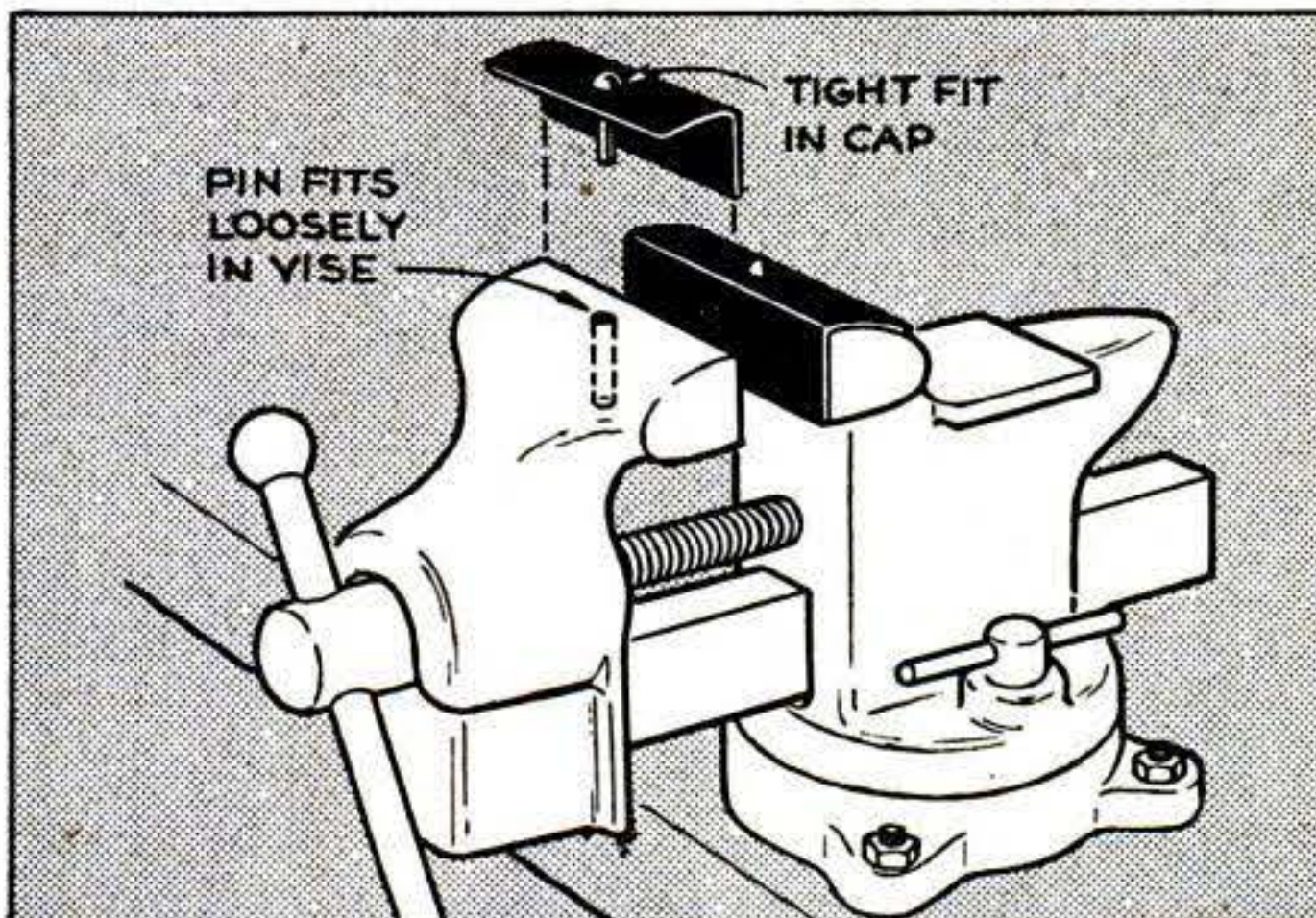
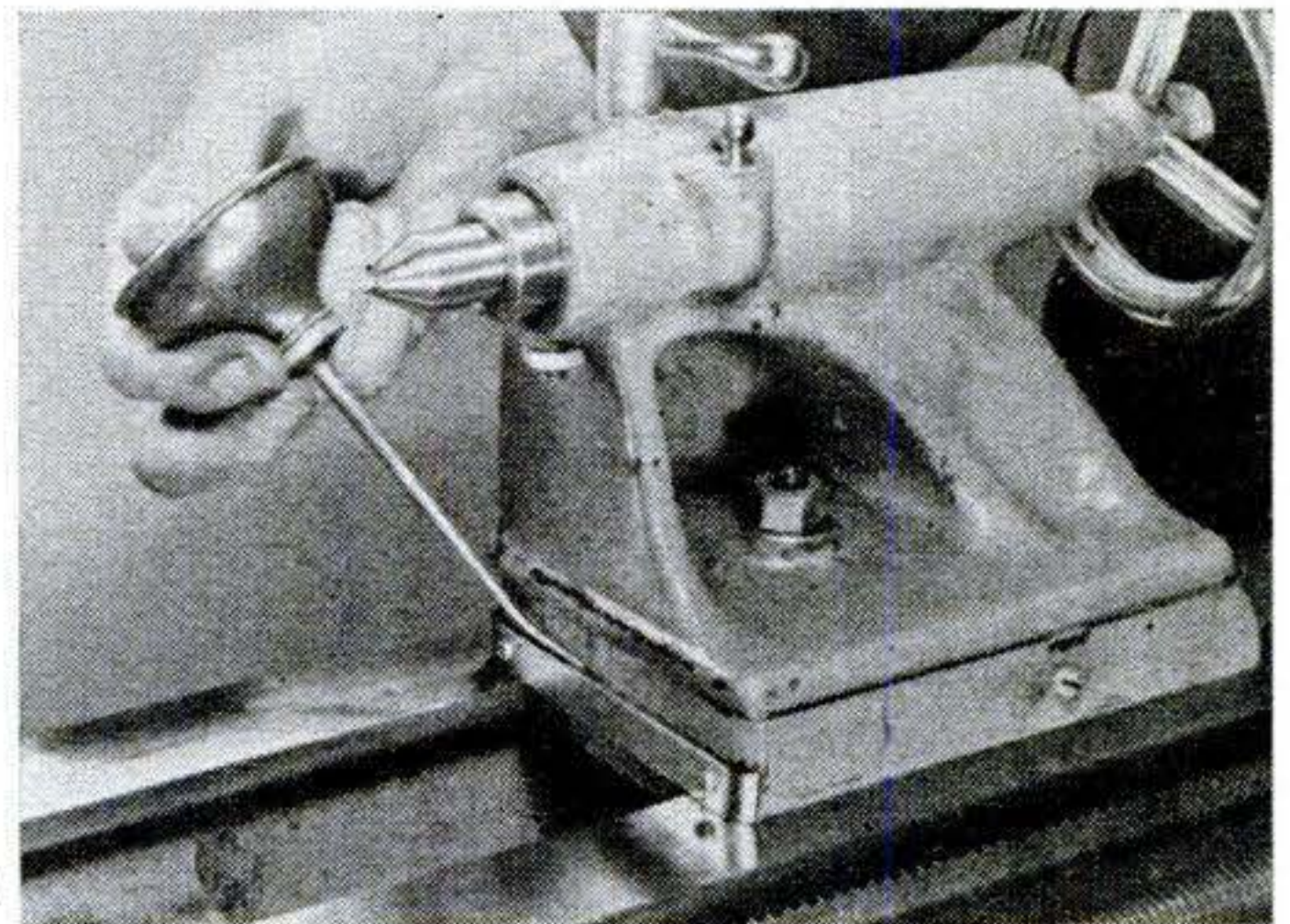

Soft Jaws Stay Put. Slip-on vise jaws used to prevent marring are awkward and always seem to drop off when your hands are busy. Pins set in them end the trouble. Spot a hole in each at the same position, clamp both in the vise, and drill the holes through into the vise jaws. Secure the pins in the loose jaws by screwing, riveting, or soldering them.—JOHN A. BLAKER.

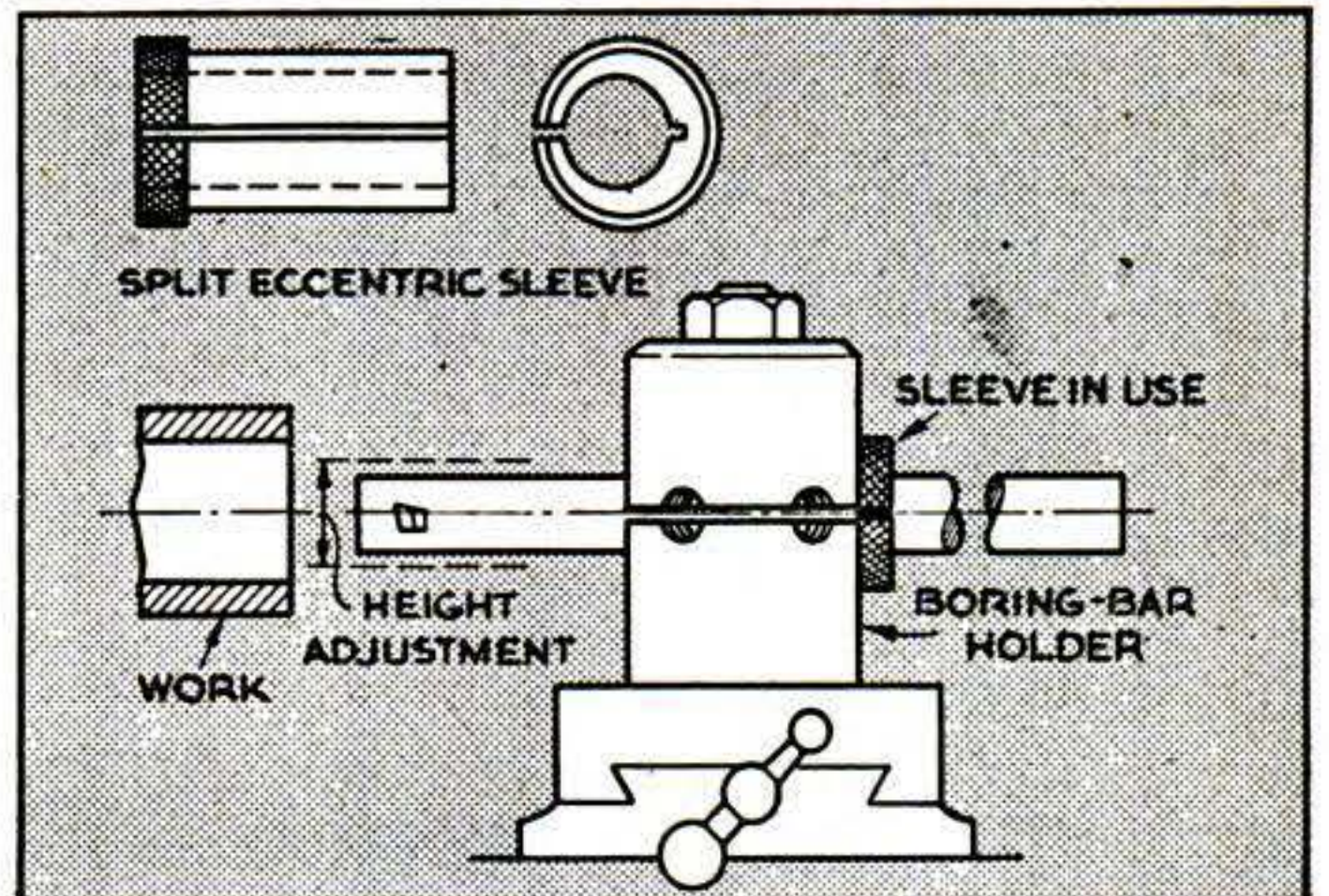

Sleeve Adjusts Boring Tool.

Many boring-bar holders have no height adjustment. The split eccentric sleeve shown gives a good range, a twist raising or lowering the bar while keeping it perfectly level. Turn the sleeve outside, knurl the collar for a finger grip, and chuck it off center in the four-jaw to drill and ream the offset hole. Mill or saw the slot.

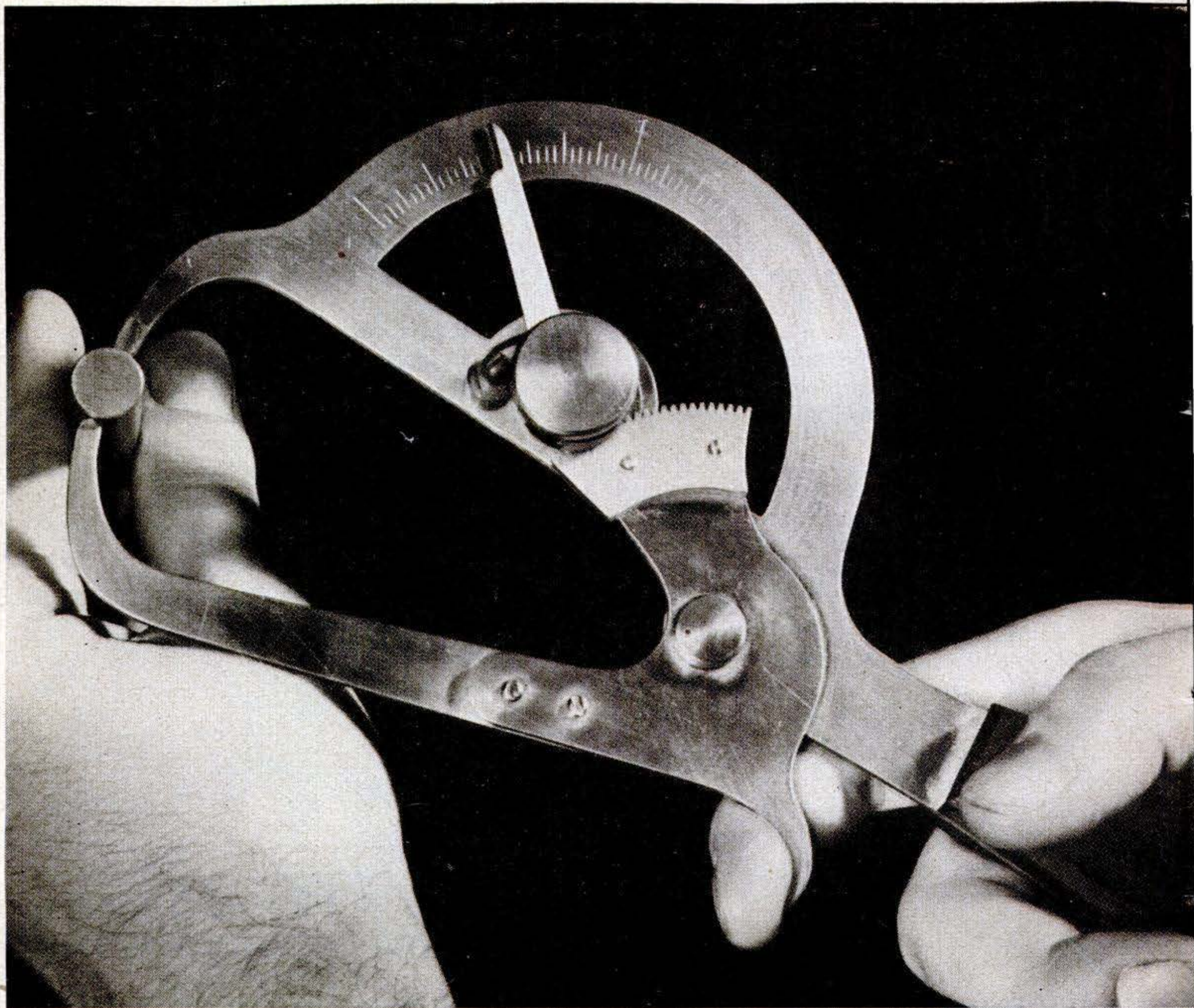

Spring-tensioned jaws gauge work quickly. The double-size scale makes for reading accuracy.

Spring Calipers Give

By **Herbert Pfister**

PICK up these spring calipers and you've got a reading before you can say, "What size?" The geared pointer indicates on a magnified scale, making it easier to read small fractions. It's a fascinating job to turn out this toolbox gadget.

You can save time by getting some $\frac{1}{4}$ " graph paper instead of drawing the $\frac{1}{4}$ " squares. On this, trace the patterns for pieces A, B, and C by following them from square to corresponding square. Cut out and paste the patterns on $\frac{3}{32}$ " brass to minimize waste. A metal-cutting bandsaw

or jigsaw will make short work of cutting, but if you are patient the work can be done with a stout metal-cutting blade in a jeweler's or a coping saw. Cut the pointer E from $\frac{1}{16}$ " brass.

Do all filing, drilling, and tapping on these parts first. Secure leg B to piece C with two 2-56 screws. Place a 3" gear that has a $\frac{1}{4}$ " hole (or is bushed to that size) on $\frac{1}{4}$ " rod set in the hole in piece C. Drill through this and the gear for two rivets. Cut out a $1\frac{1}{2}$ " gear segment with the holes and rivet it on with escutcheon pins.

A detail at the top of the drawing shows how the pointer E is riveted to the hub of

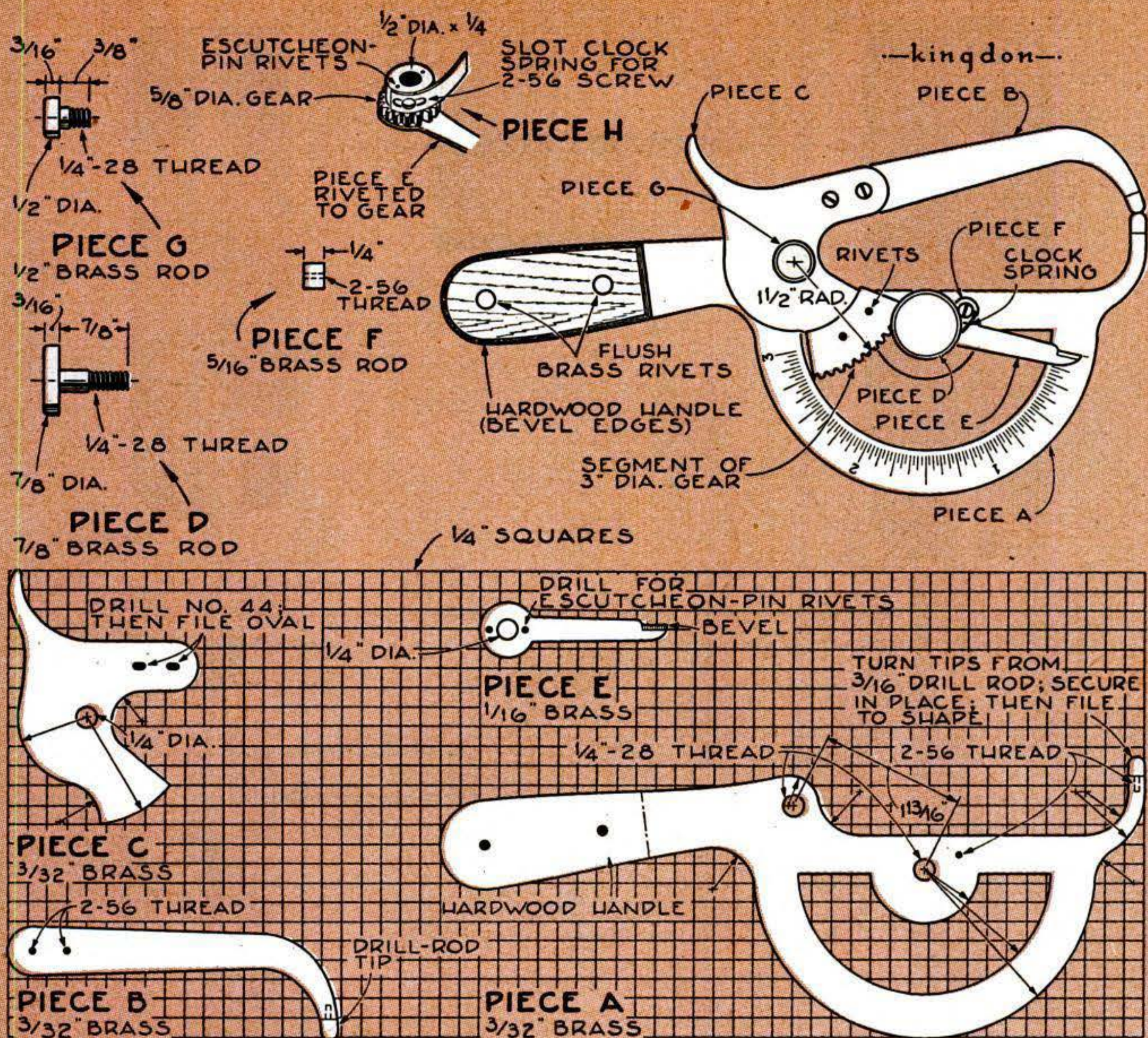

Turned studs *D* and *G*, which serve as pivots, thread into *A* and are locked with nuts beneath.

Quick Measurements

a $\frac{5}{8}$ " gear. The slotted end of the clock spring is secured with a short 2-56 screw for which the hub is tapped. The other end hooks around a 2-56 screw in part A, spacer *F* raising it to the gear hub.

Drill and tap the jaws of both caliper legs to receive two shouldered bits of $\frac{3}{16}$ " drill rod threaded 2-56. Turn these up tight and solder; then file them flush all around with the jaws. Fasten two pieces of hardwood to the handle end of *A* with flush rivets and shape them to it. Polish the brass with fine steel wool and shellac the handle.

Mount the movable leg on the turned stud *G* and lock with a nut beneath. Put

the small gear with its spring and pointer on stud *D*, meshing with the segment so that the jaw tips touch before the pointer contacts collar *F*. Hook the spring on with just enough tension to bring the tips together decisively. Edge-on views on page 194 show assembly.

You can calibrate the scale by placing pieces of drill rod or other accurately sized stock between the jaws and scribing deeply right along the bevel of the pointer. Use a scale to divide the intervals so obtained into thirty-seconds. Another method is to hold slide calipers locked at steps of $\frac{1}{32}$ " between the jaw tips to scribe the scale. 

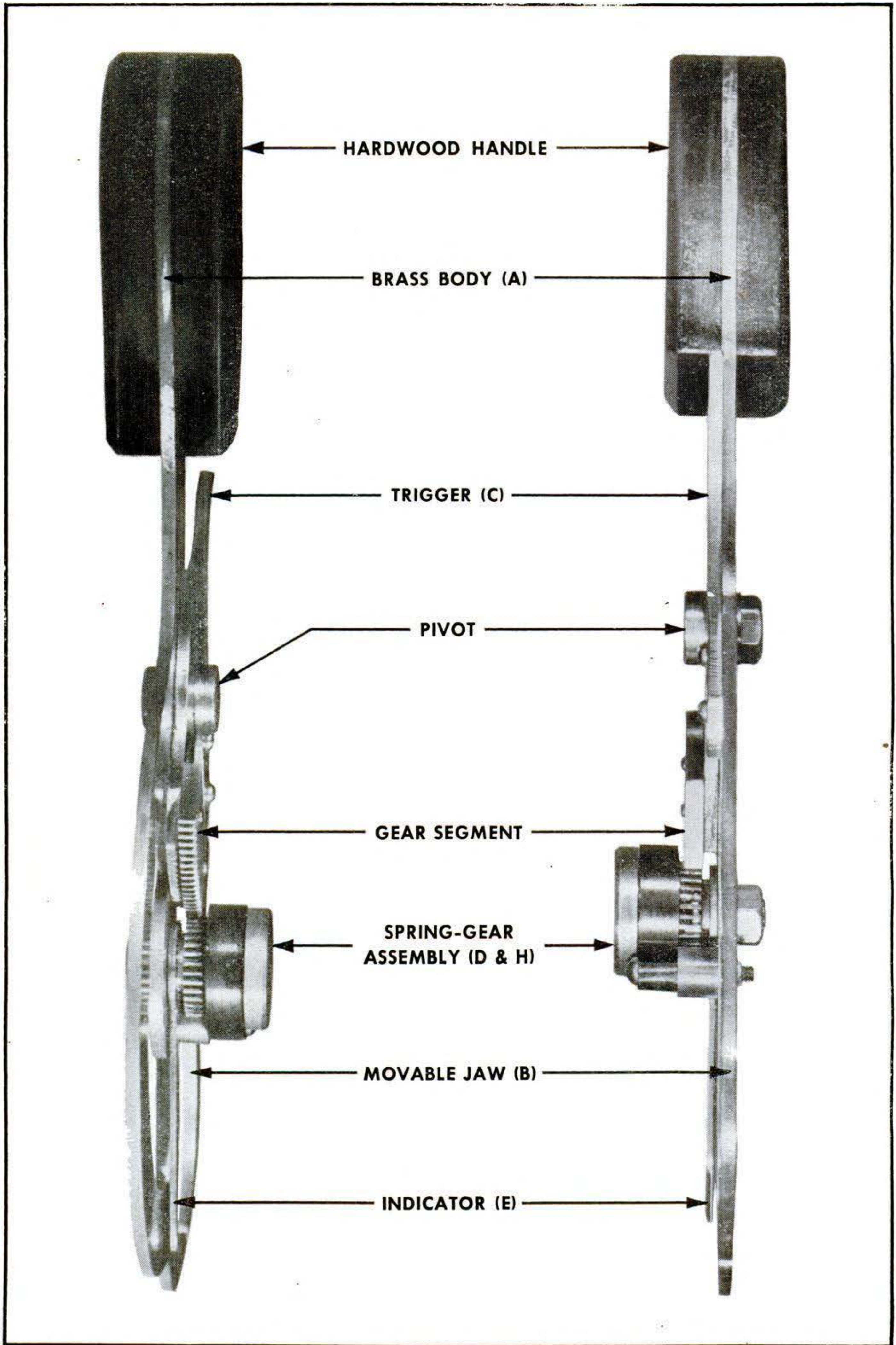

Edge-on views from opposite sides show calipers assembly. Note spacer under the spring end.



Magnet Aids Welder. A magnetic dispenser for use with arc-welding starter powder is made by the Electrical Engineering Company, of Indianapolis. It consists of a weighted base enclosing an alnico magnet, with a conical depression in the top. Placed in the depression, the powder becomes magnetically charged. When a welding rod is dipped in it, enough powder attaches itself to the tip of the electrode to start an arc. The powder (PSM, April '47, p. 197) helps strike arcs at low amperages.

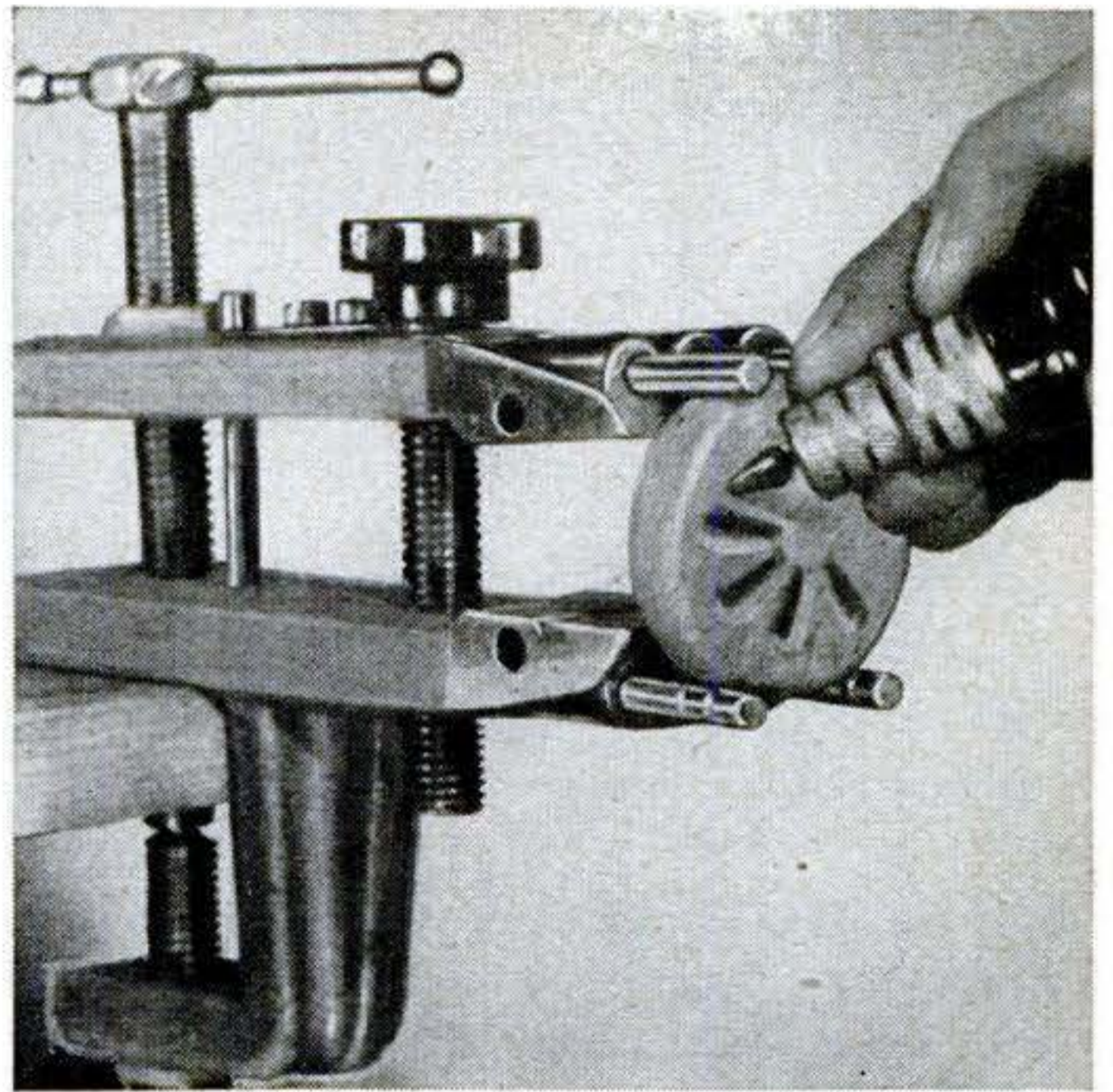

Vise Grips Odd Shapes. In addition to clamping work in the usual way, a bench vise offered by Benjamin Uydess & Sons, Inc., of New York, includes removable steel fingers that make it possible to grip disks, balls, hemispheres, and irregular shapes of almost any kind in convenient working position. Priced at approximately \$15, the vise also comes with a ring-arbor attachment that slips over one of the steel fingers. Tubular work is clamped then between the arbor and a second steel finger.

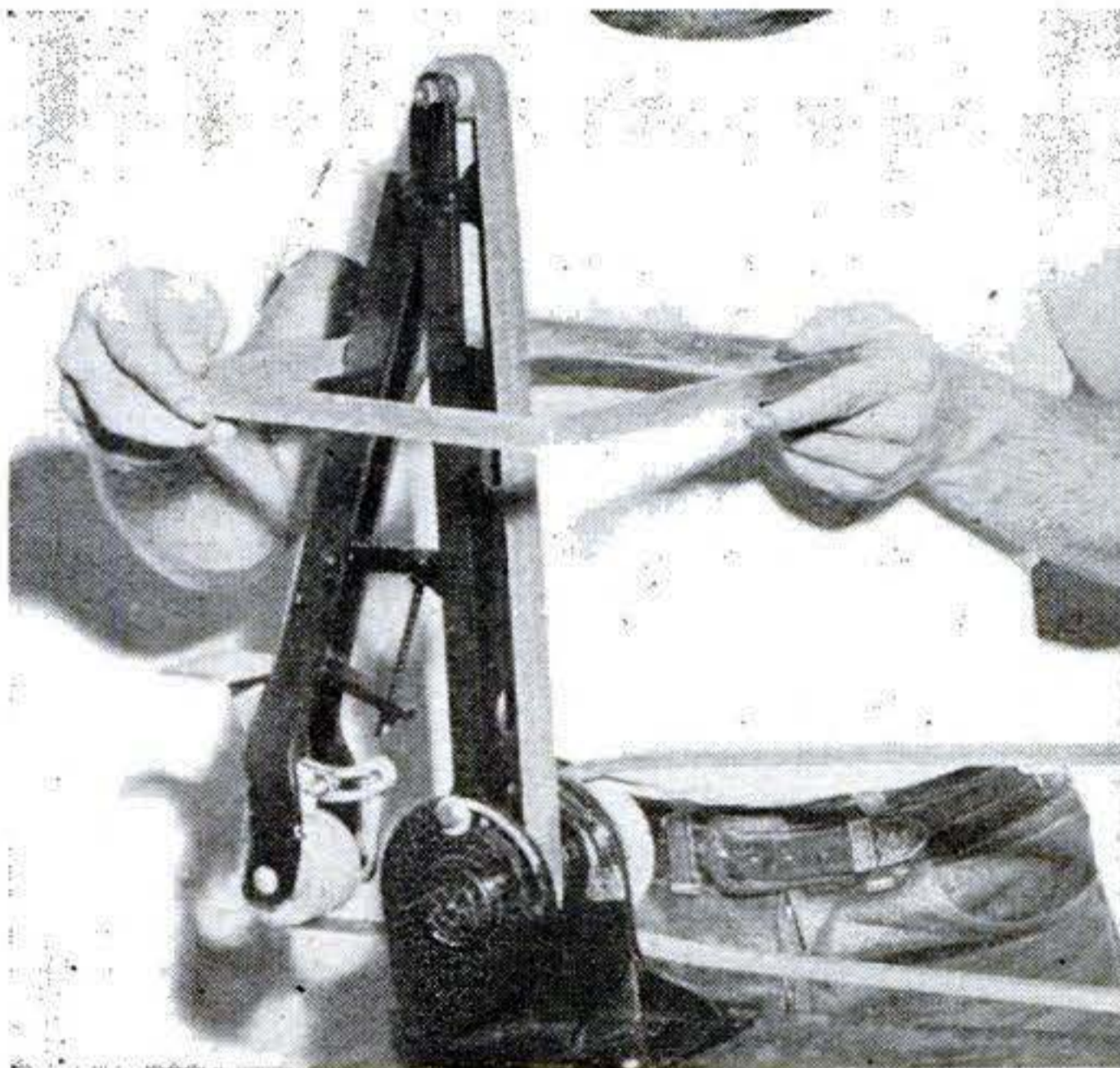

Sander Is Versatile. A pivoted framework that locks in any position from vertical to horizontal adapts a belt sander made by Grover Products, of Los Angeles, to a variety of jobs. Tension of the standard 1" by 42" belt is easily adjusted with a wingnut. Ball bearings provide smooth operation. The sander sells for about \$19.

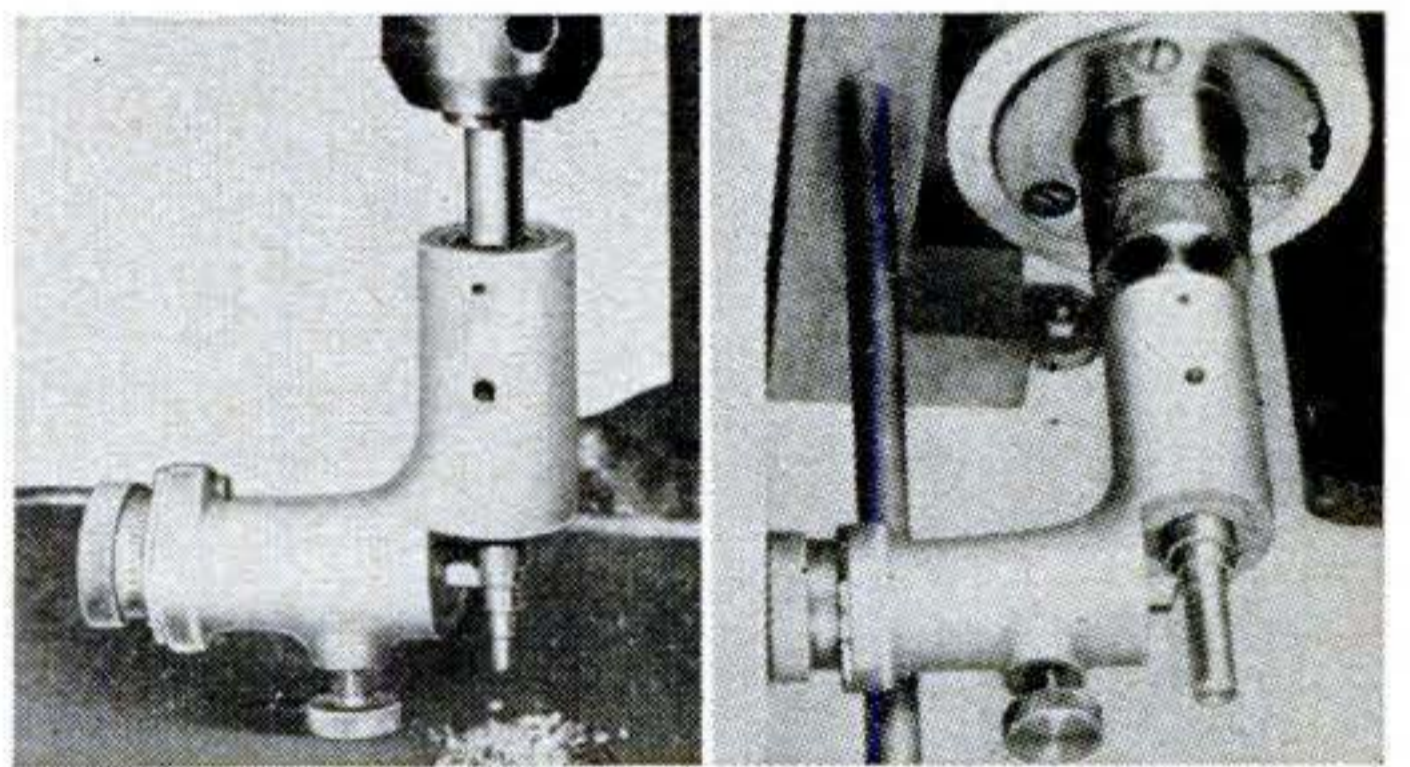

Attachment Turns Metal. With this new attachment, a drill press, wood lathe, grinder, or even a polishing head may be used to turn or cut bar-stock steel, bronze, or aluminum. Priced at about \$12, it consists of an L-shaped unit with a built-in micrometer feed and locking screw, two guide bushings $\frac{3}{8}$ " and $\frac{1}{4}$ " in diameter, and one bit each for steel, bronze, and aluminum. For wood lathes and grinders, the manufacturer, the Millholland Screw Products Corporation, of Indianapolis, also offers a face-plate chuck for an additional \$4.50. The bits are self-positioning when they are locked in the micrometer tool slide.

They Built PSM Projects

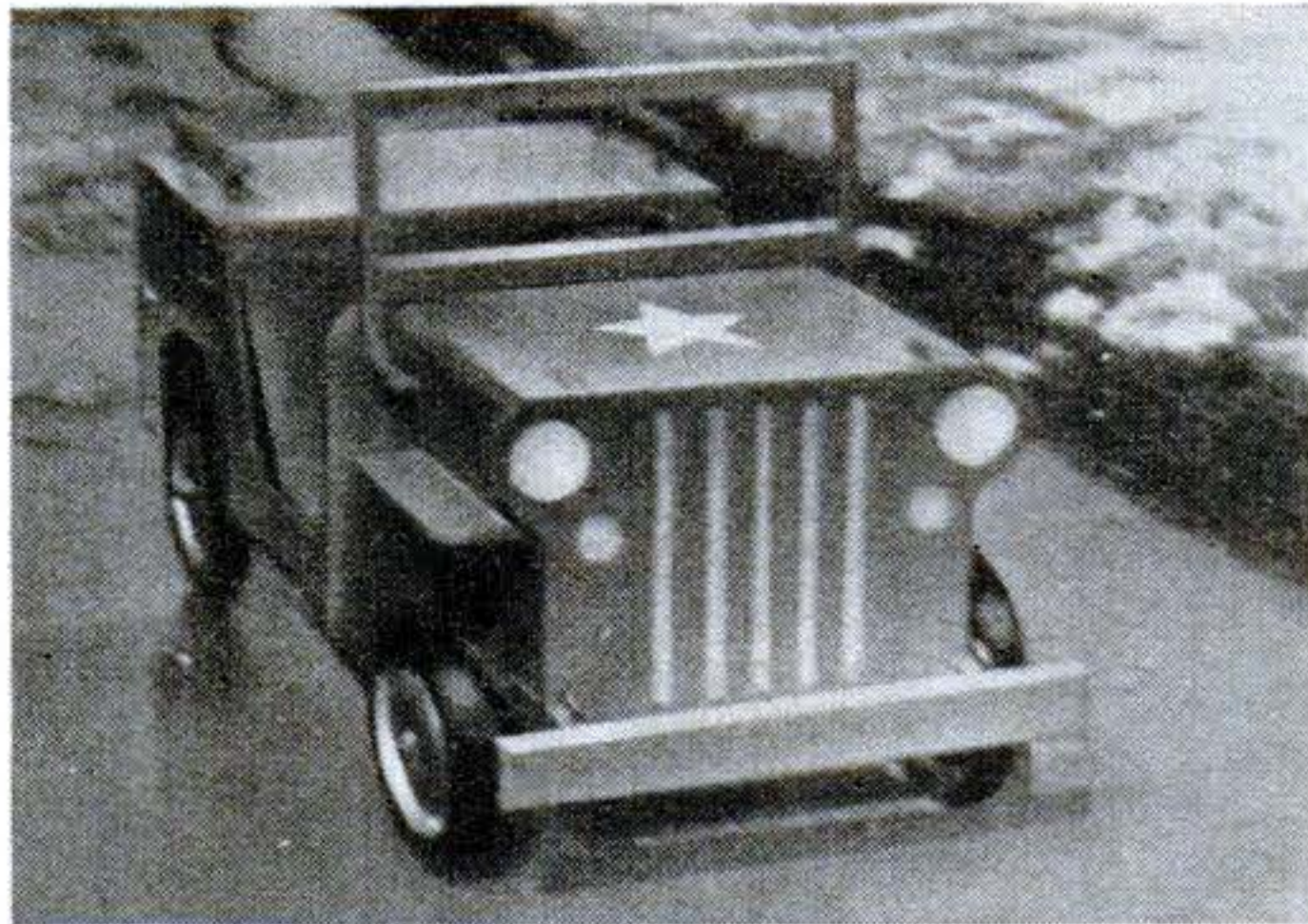

Jeeps Still Have Glamor. For their young owners, there's plenty of excitement left in these pedal-powered composites of the two plans offered PSM readers in Dec. '45. Above, a version of "Bizerte Gertie," made by G. E. Nicholls, of Wanganui, New Zealand, who had to use such Australasian wood as jarrah and rimu. Vernon Jahr, Bemidji, Minn., combined some of Gertie's features with those of the wooden jeep, and his wagon is shown at the upper right. For his first handicraft project, E. Kirchener, of Cleveland, built the model at right.



Bell Ringer Plays Music. When William DeWolf, of San Francisco, built his bell-ringer tower (PSM, Dec. '45) he put two phonograph motors to good use. Instead of the ringing mechanism originally described, he uses one motor with an off-center pivot to pull the bell cord. The second motor plays Christmas recordings into the bell tower. Another adaptation consists of a cross studded with flashlight bulbs.

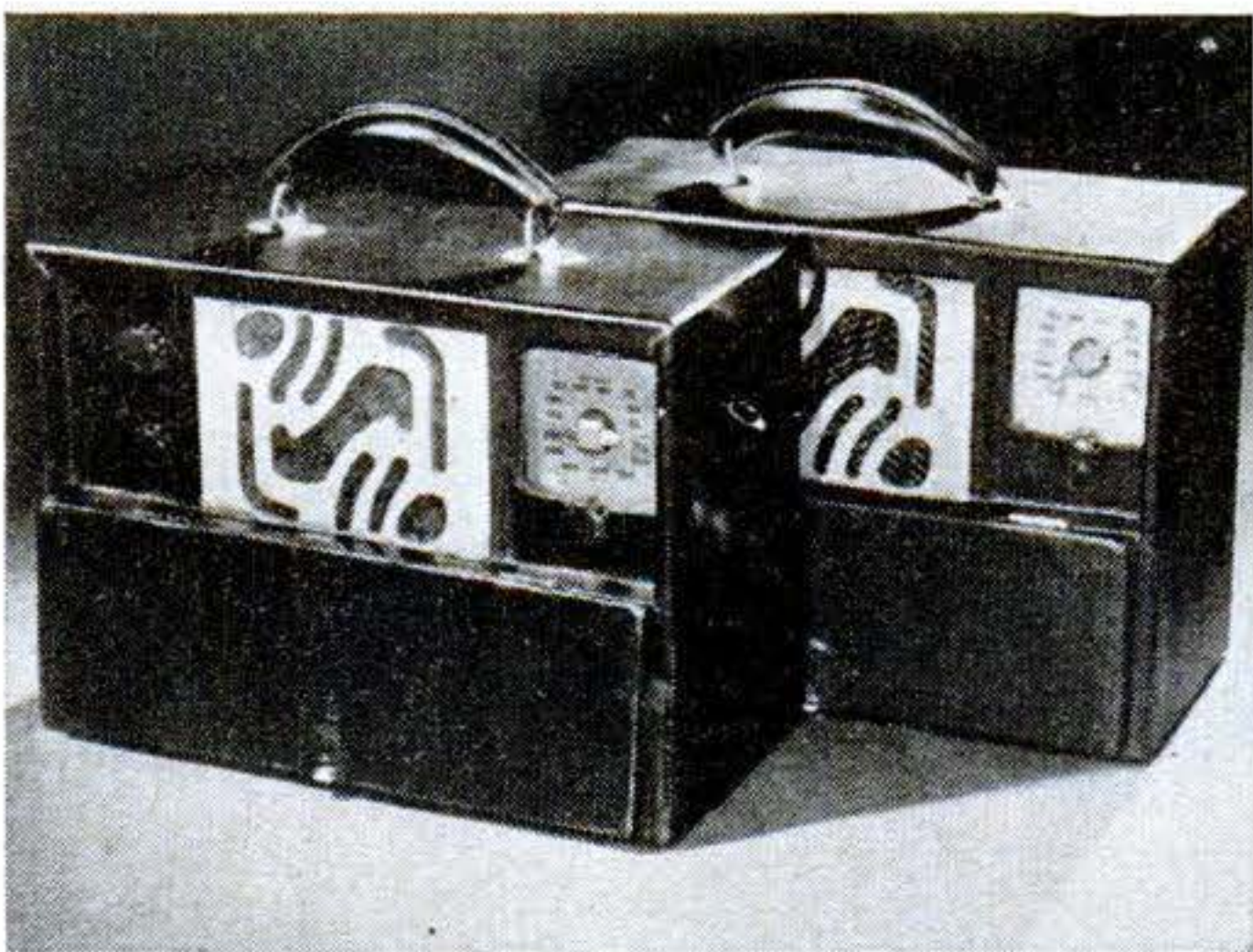

It's Good Enough for Two. At least that's what John Serina, New York, thought when he completed one of the three-way PSM portables pictured above, so he built a second one as a gift for one of the set's many admirers. The cases are entirely of Mr. Serina's design, being different in most respects from the original two-part cabinet described. Outer covering is of leatherette, and the half door opens on the dial, controls, and a jigsawed hardwood inlay over the speaker grille.

Fuel Oil Pumped from Cellar to Upstairs Outlet

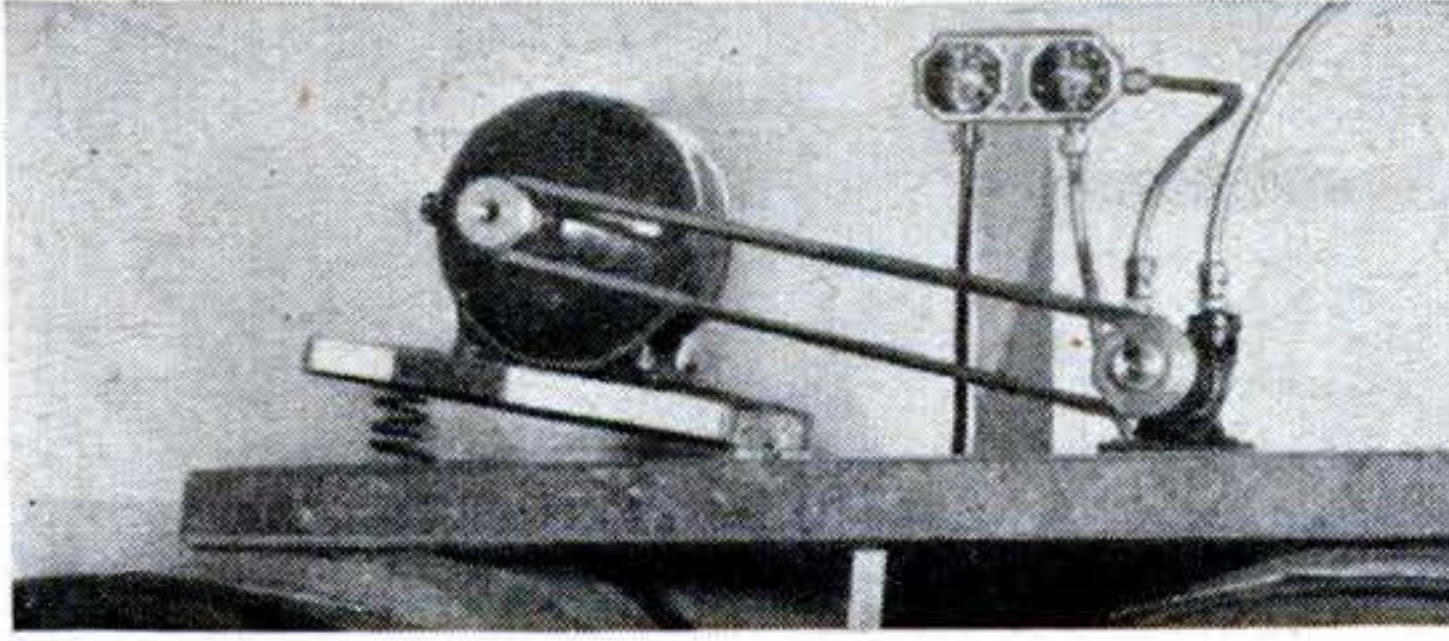

THIS pump unit was rigged up to eliminate the necessity of lugging oil from the cellar every time a kitchen-range tank needed filling. A switch upstairs near the oil outlet turns on the motor.

The pump was obtained from an old furnace oil burner and the $\frac{1}{4}$ -hp. motor from a washing machine. By mounting the motor on a hinged base, its own weight was utilized to help keep the V-belt tight. A coil spring under the raised end of the mount takes excess strain off the belt.

The $\frac{5}{16}$ " tubing from each barrel was

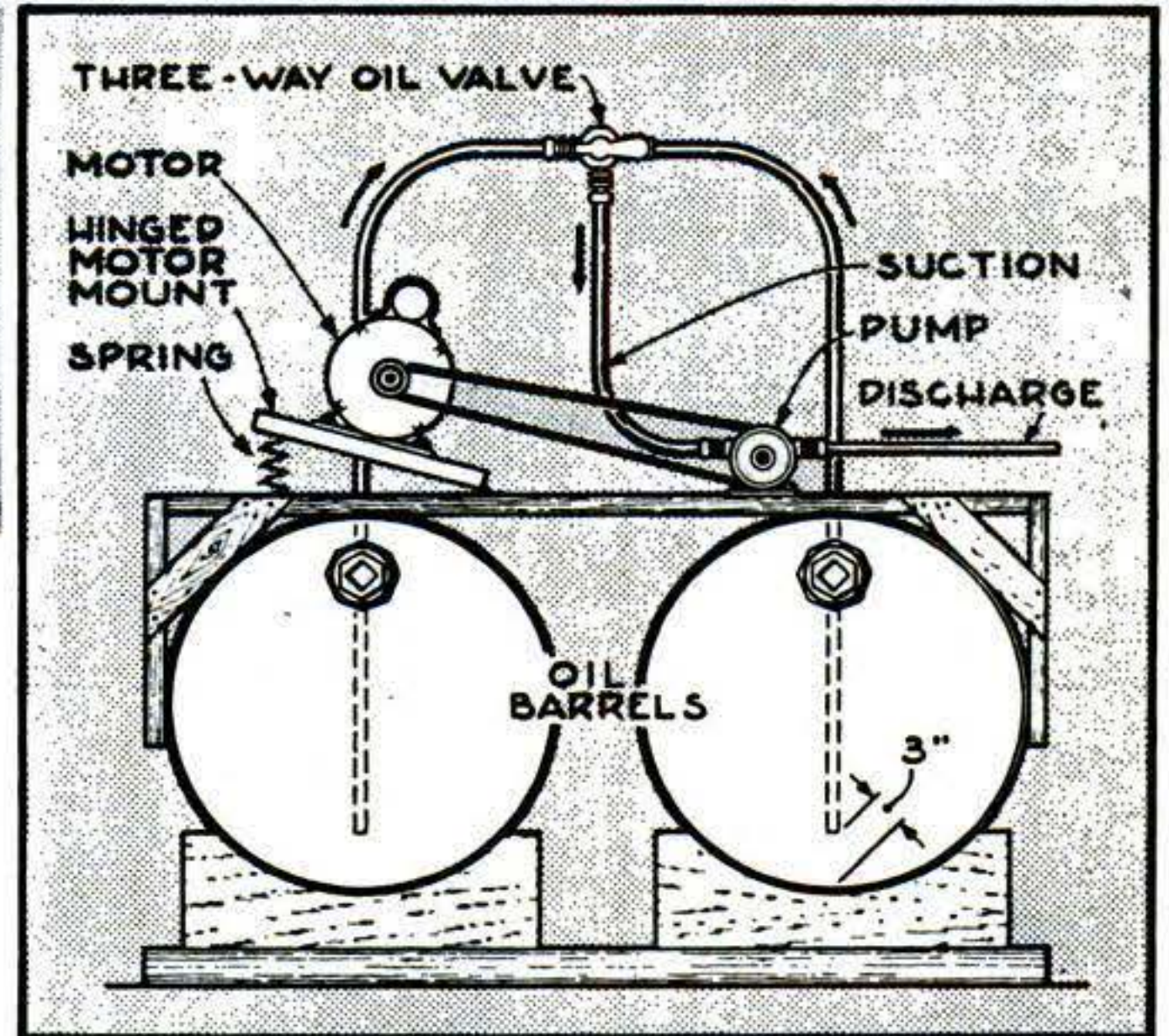

led to a three-way oil valve. Ours consists of two gas-stove valves attached to the pump suction line. This makes it possible to switch from one barrel to the other, and refill the empty one.—A. J. SEYMOUR, JR.

Clips Hold Rolled Blueprints

BLUEPRINTS that have been rolled up may be prevented from rolling off the end of a table by two or more stops fashioned from paper clips.

Bend the clips to form an angle and then secure them to the table with thumbtacks. With these in place, several rolls can be conveniently stacked in no danger of sliding off the table.—W. B. EAGAN.

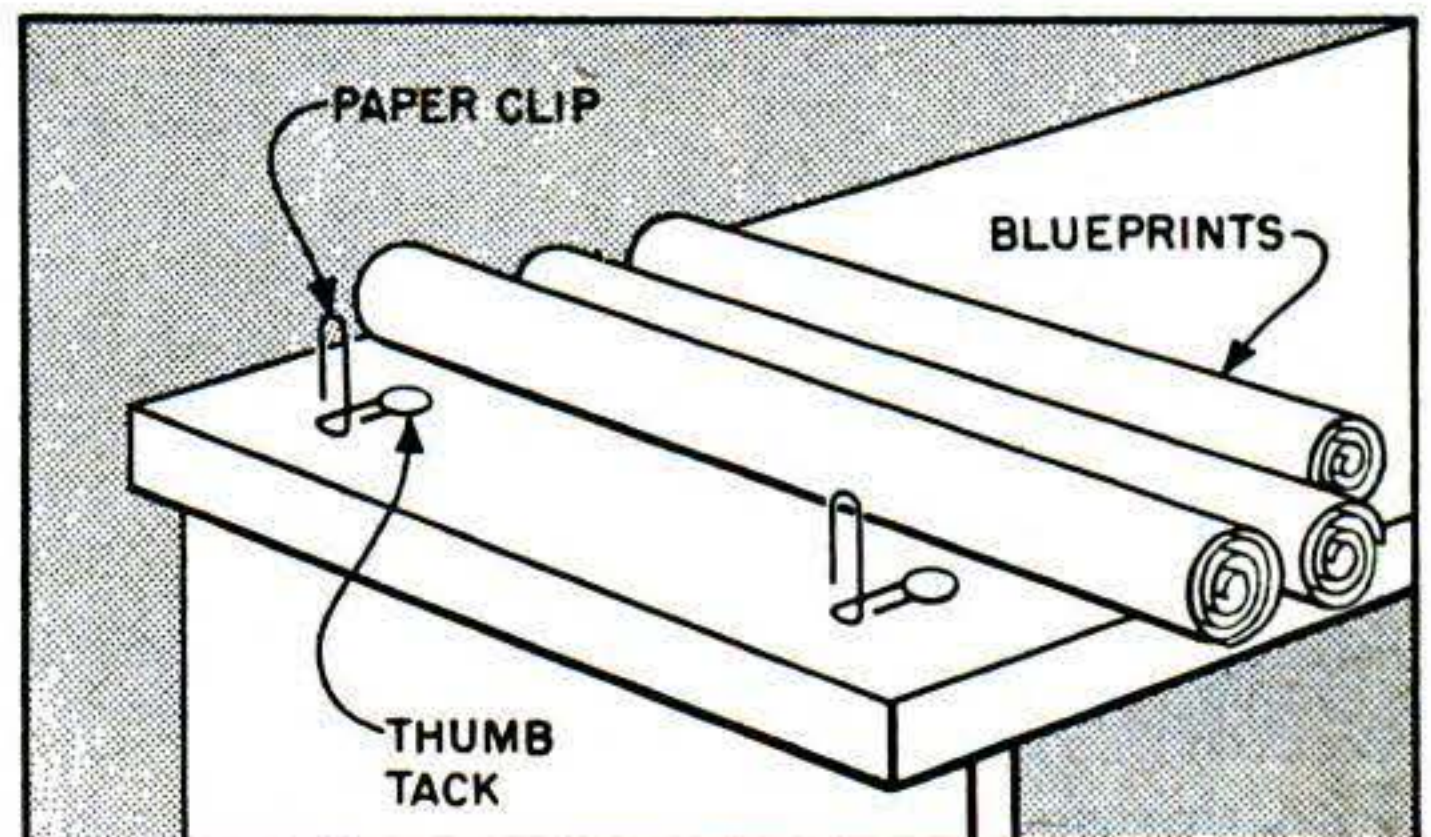

Heater Made More Efficient

IF YOUR pot stove is the type that has a water jacket only around the dome, its efficiency can be virtually doubled by winding a continuous length of copper tubing around the firepot and connecting the coil into the household hot water system.

Tubing from $\frac{3}{8}$ " to $\frac{1}{2}$ " can be used. You will need from 20' to 35', depending on the stove size and the number of turns you want. Pipe-thread adaptors will provide the connections to the hot and cold water pipes. You will also need two sweat-fitted elbows. In making the connections, remember that the bottom of the coil should connect to the cold return and the upper to the hot-water lead. Fasten wire screening over the coil and on this trowel a $\frac{1}{2}$ " layer of asbestos cement as insulation to conserve heat.—JOHN MRACEK.

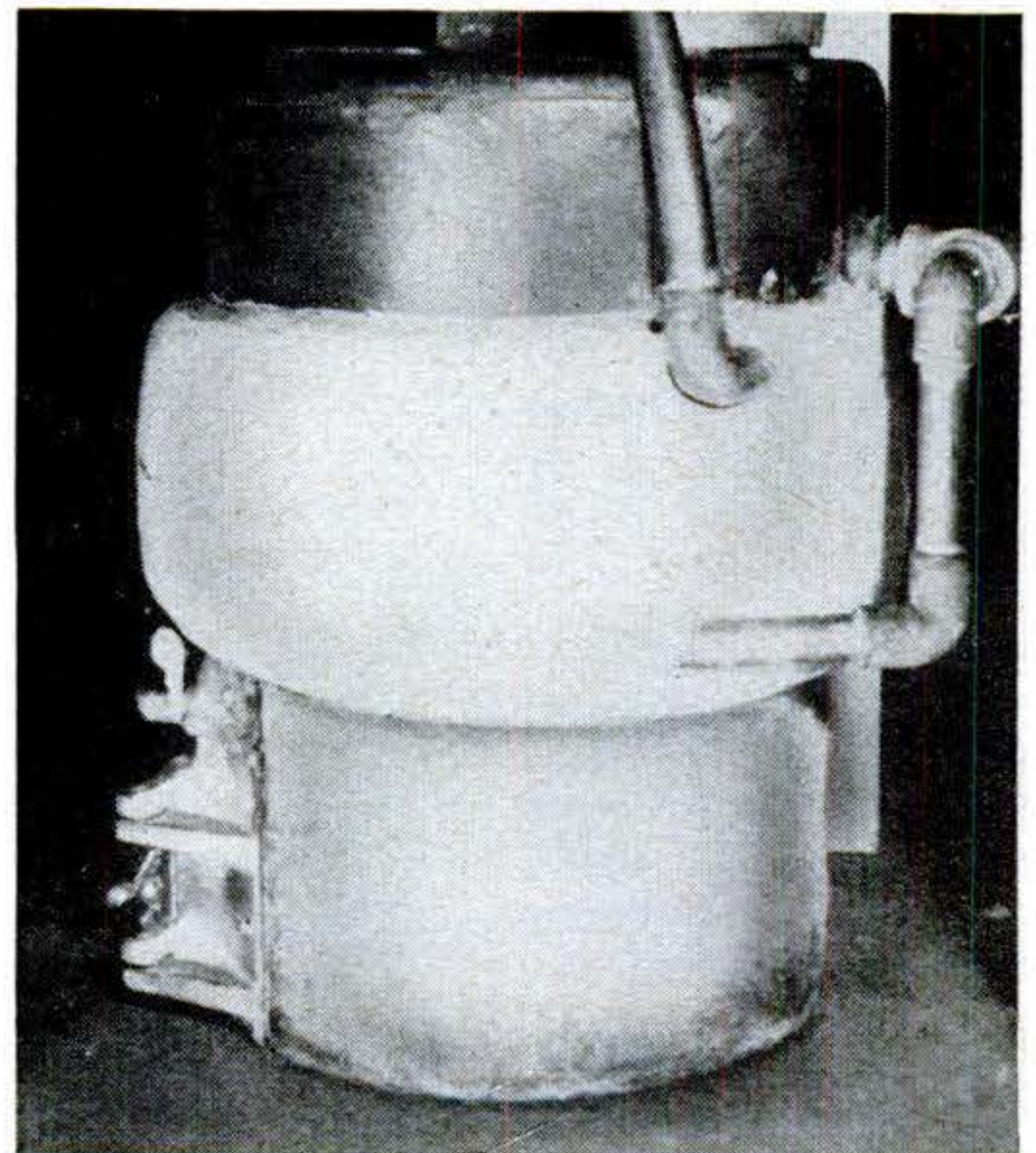

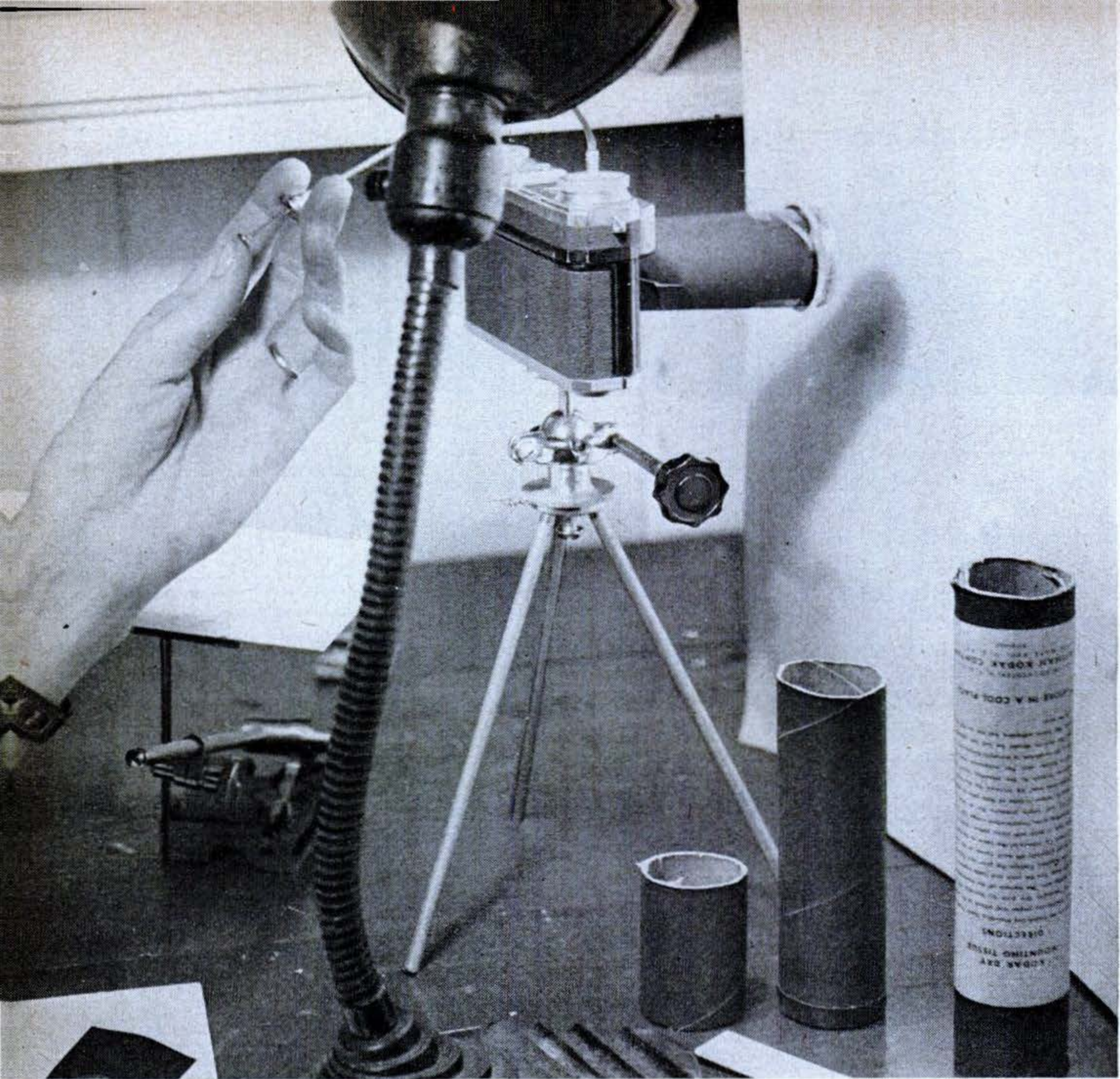

With this simple setup, you can photograph small objects at many times their original size.

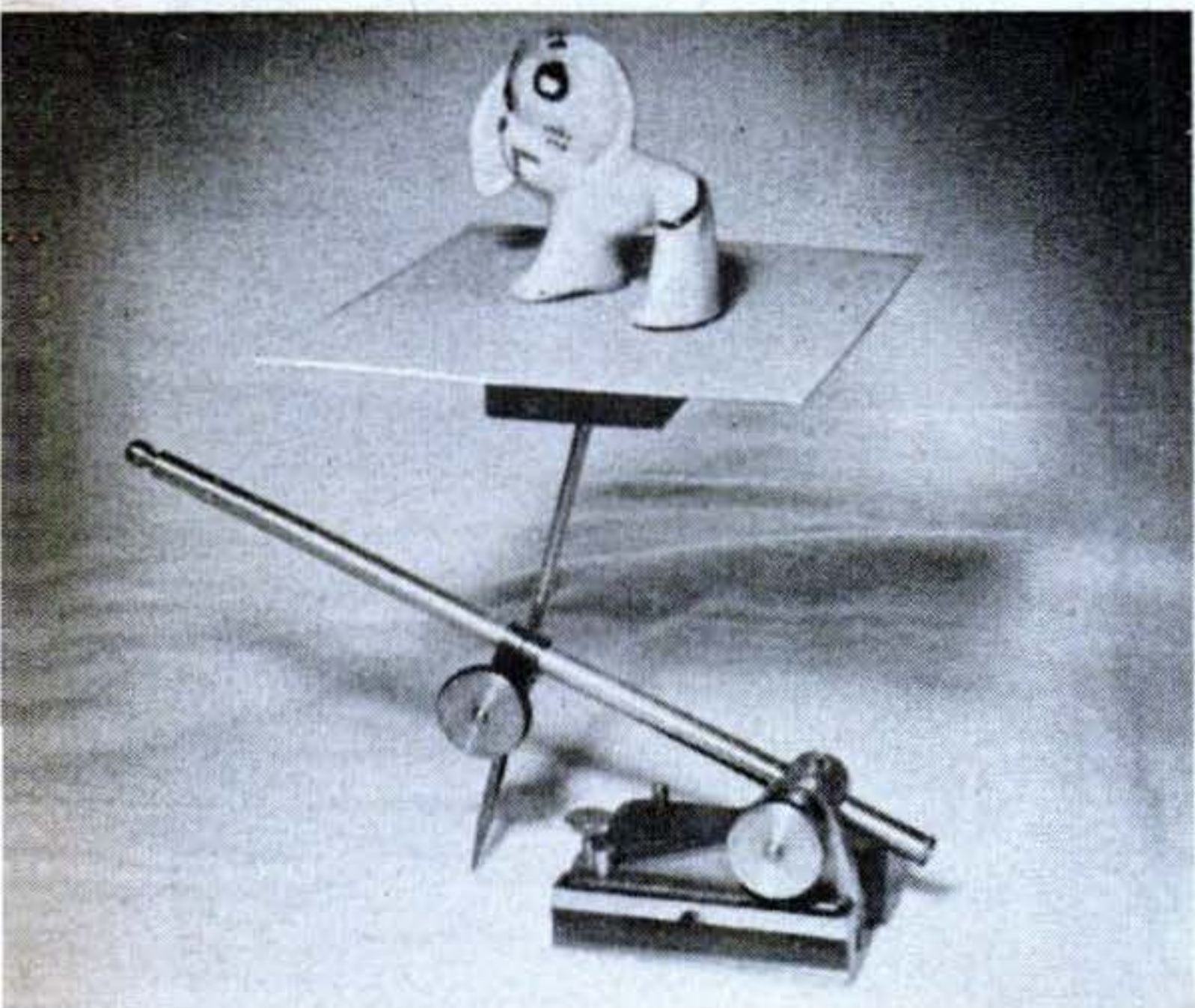

A machinist's gauge with a platform attached provides a flexible stage for your subjects.

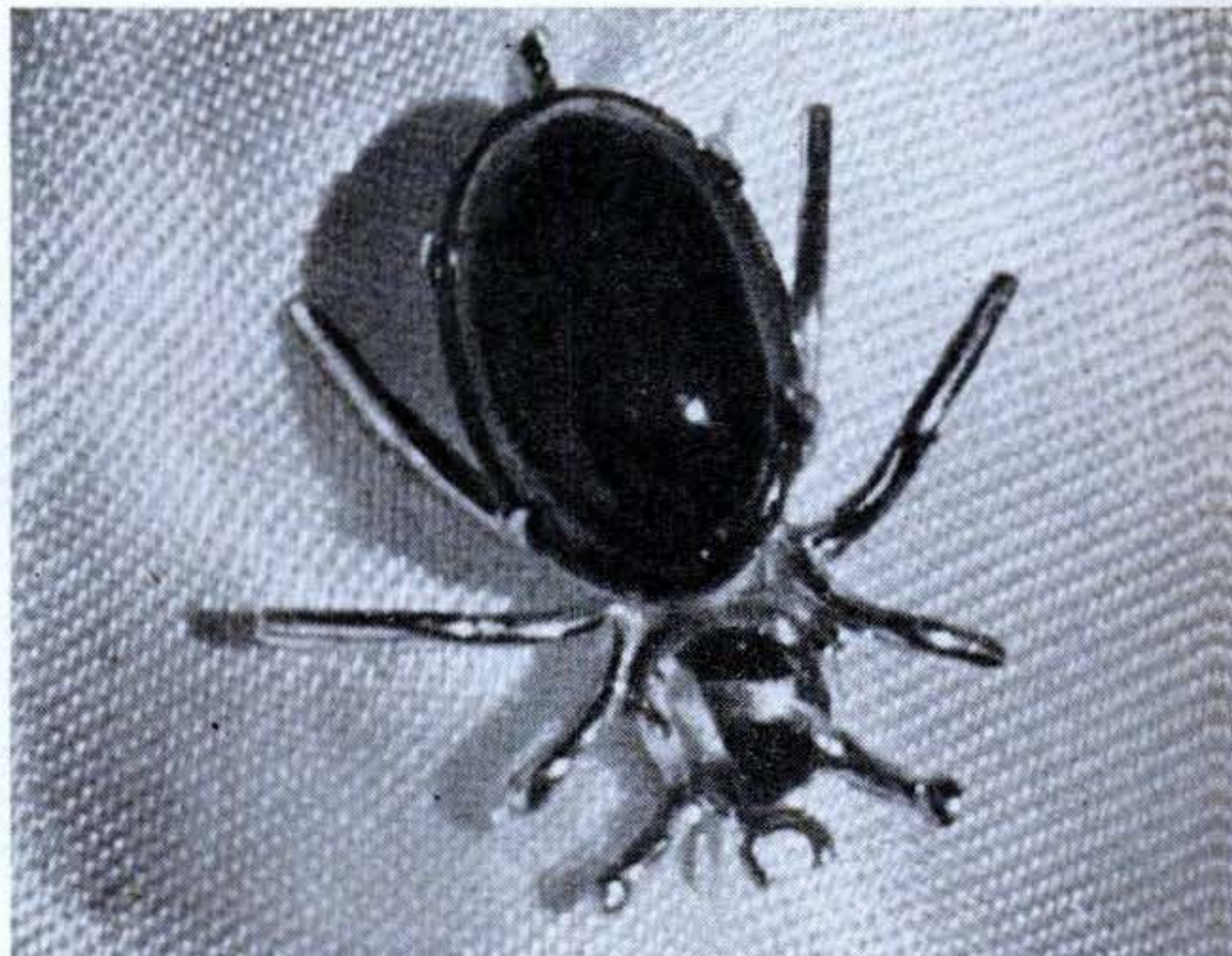

Only $\frac{1}{4}$ " long, this pin was increased in size by photographing it through a tube 1" long.

Lens Tubes Shoot 'Em Big

Bigger-than-life blow-ups are a cinch with these homemade lens tubes. They'll work on almost any camera.

By Charles Smith

PICTURES that show small objects bigger than life size can be taken with almost any camera, provided it has a removable lens. The trick, of course, is to use a lens extension tube. Don't fret if you do not have facilities to machine metal tubes; cardboard tubes do nicely if fitted with care.

Take the lens out of your camera (if you have a between-the-lens shutter, remove the whole unit), and fit a short tube in the hole in the lens mount. If you can't locate a tube of the right diameter, build up one that's a loose fit, using strips of glued paper. It's well to make several tubes of different lengths at the same time—ones 1", 2", and 3" long will do as a starter. The lens should be fitted to the outer ends of the tubes, again using glued paper rings if necessary. Coat the inside of each tube with flat black paint, and be sure the tube screws squarely into the camera and the lens screws squarely into the tube.

If your camera has a ground glass, you're now set to try a few shots. If not, the pro-

per focus for each tube must be determined first. Remove the back of the camera and tape a piece of ground glass or tracing paper in the plane the film occupies. With the shutter open, move an object back and forth in front of the lens until you find the sharpest focus. A piece of graph paper is handy for the purpose since it also shows the exact area that can be photographed with a particular tube. Block off on the paper the field that each tube covers. This provides a ready guide as to which tube must be used to cover any object photographed.

After the test object has been brought into sharp focus on the temporary ground glass with the lens wide open, carefully measure the distance from the lens to the object. Make a notation of this, along with the size of the area covered.

Because the distance from the lens to film has been increased, it will also be necessary to compute—and keep a record of—an exposure factor for each tube. This factor may be determined by measuring the distance from the lens to film, squaring this distance, and dividing by the square of the focal length of the lens. This yields the number of times you must multiply the exposure that would be normal for any given lighting condition without the tube.

If at all possible, use a tripod to support

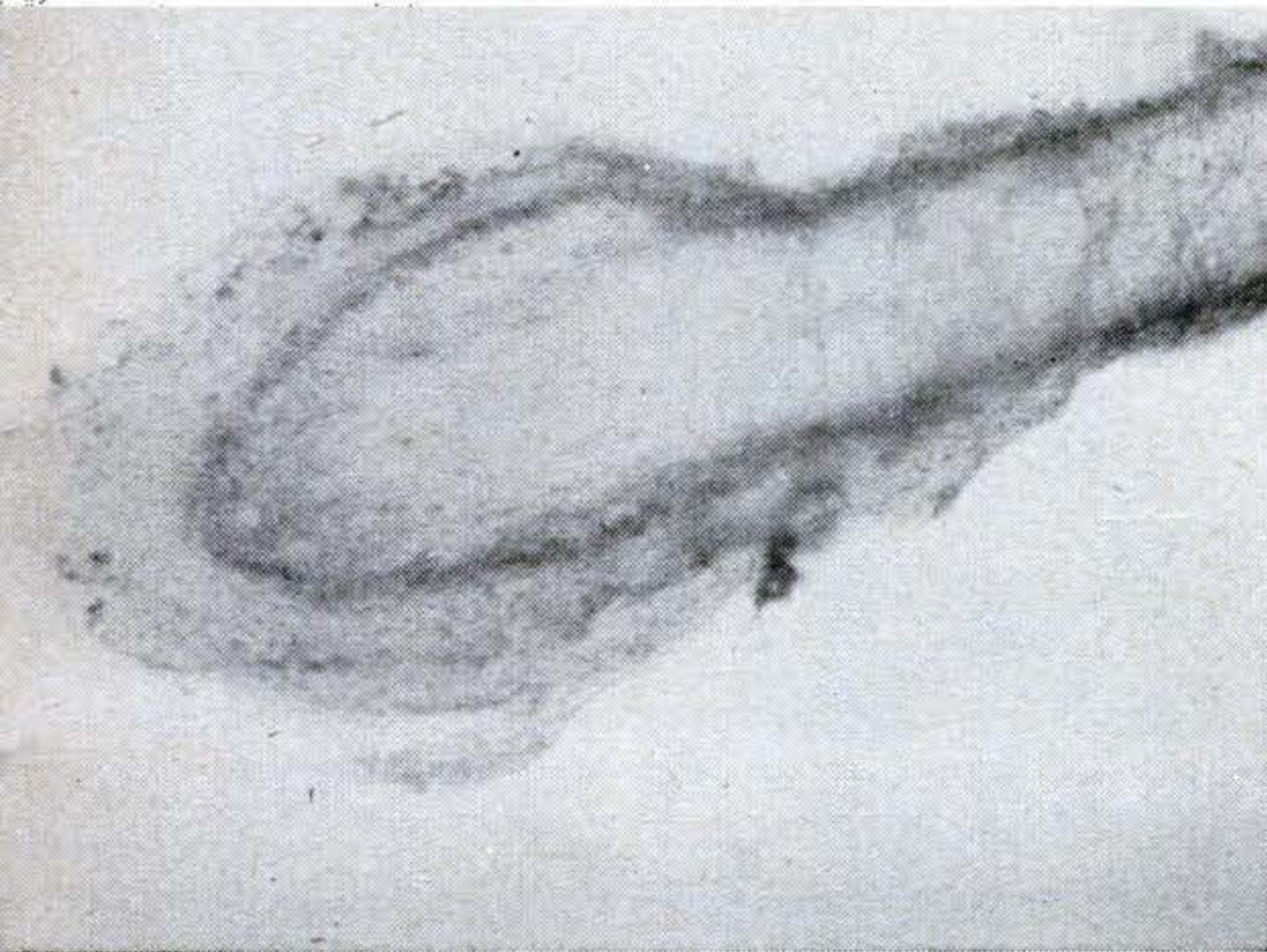

A hair root magnified 50 times. A microscope objective was used as the lens in this case.

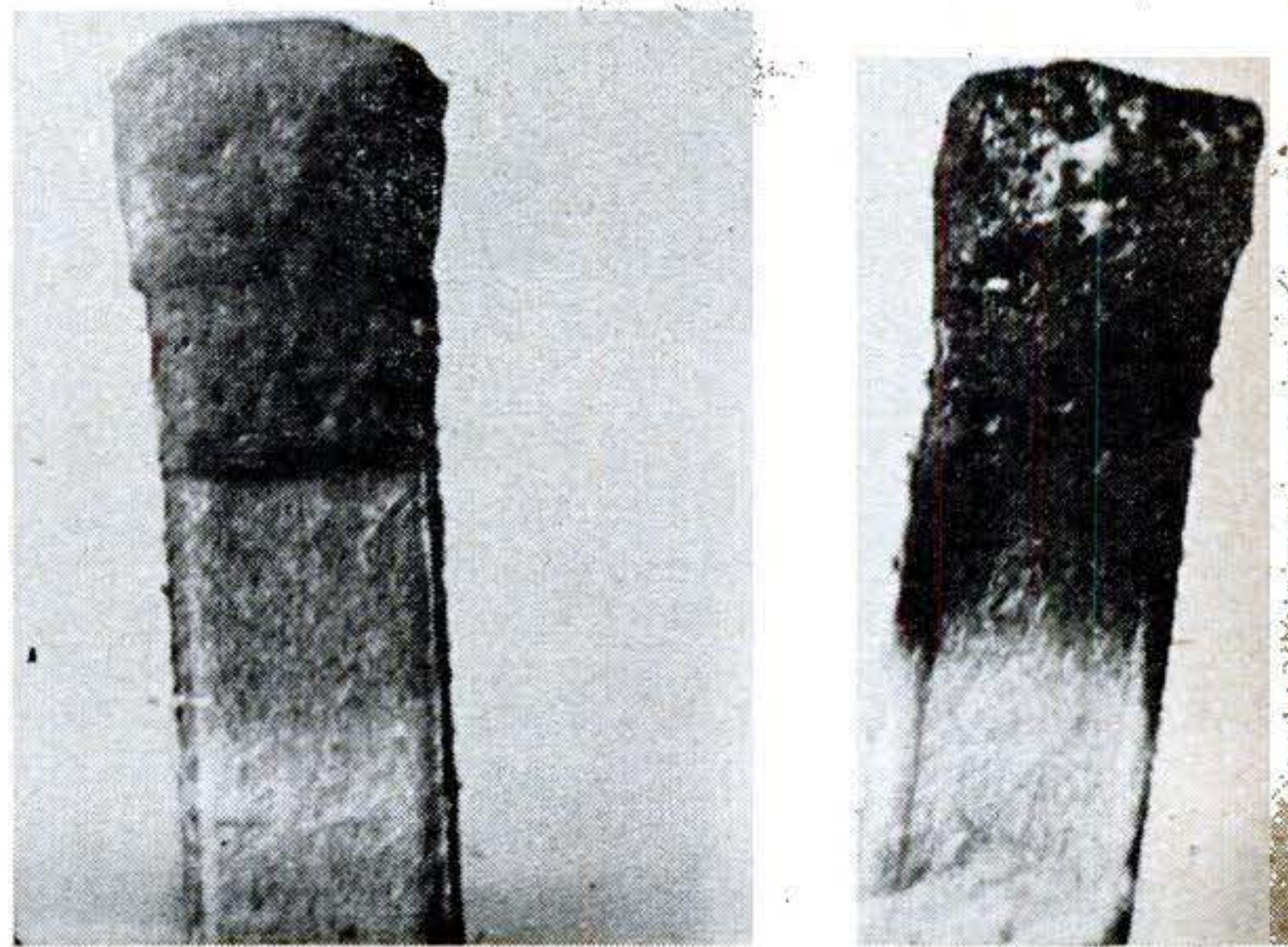

Two match heads present this appearance when pictured through a tube. One has been burned.

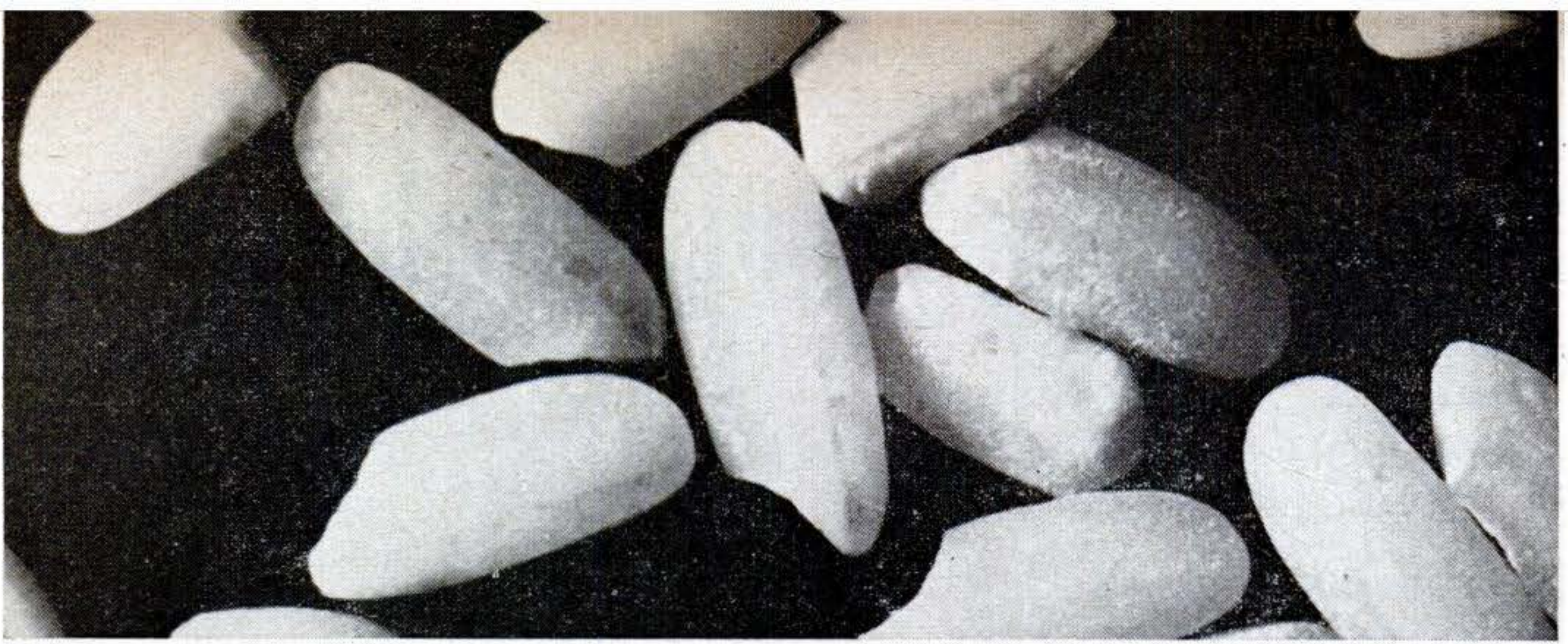

Placed on a black background, these rice grains were photographed through a tube 1" long.

the camera, and if the tube tends to sag, install a prop to keep it at right angles to the camera. Exposures should be made with a cable release, for any vibration will spoil the picture. If you have no cable release, shut off the room lights, open the shutter, and use the light switch for exposures.

Any illumination may be used, but I find a gooseneck lamp very convenient. For contrasty spotlighting, I also sometimes use a slide projector. Masks for spotlighting small objects may be made by placing coins or other objects on a sheet of process film and then flashing with light. After being developed, the film can be cut and fitted in the projector as you would a slide.

Rather than disturb the camera after it has been set up, you may find it more convenient to focus by moving your object toward and away from the lens. For this, a machinist's surface gauge may be adapted

to provide a handy stage on which to pose the object to be photographed. Stick a small block of wood on one of the prongs and glue a square of cardboard to the wood. This little stage may then be tilted to any angle, raised, lowered, and the entire unit may be moved to bring the object into focus.

Exposures are no problem if you use a meter and take into consideration the exposure factor determined for the tube. If you do not have a meter, a few tests will indicate the proper exposure for any particular condition. In any case, it is advisable to go down to the smallest possible stop on your diaphragm because in this work the depth of focus is very slight.

Occasionally you may get bright streaks across photographs of shiny objects. These may be avoided by adjusting your illumination so that light is not reflected directly into the lens.

END

Gas-Mask Holder Makes a Convenient Gadget Bag

LIGHT in weight and water-resistant, a gas-mask holder may be easily converted into a bag for carrying a small camera and accessories. Its size makes it particularly suitable for a 2¼" by 3¼" Speed Graphic.

In this case, a pocket of waterproof canvas was made to fit the camera snugly. This was then sewn into the bag with ¾" sponge rubber as lining on four sides and the bottom, protecting the camera from dampness and from bumps or falls. A second pocket was installed to keep six film holders in an upright position, and a third accommodates filters, a lens hood, and other small accessories.

Overlapping flaps secured by snaps protect the contents. A shoulder strap makes the bag easy to carry.—JOHN TRIMBLE.

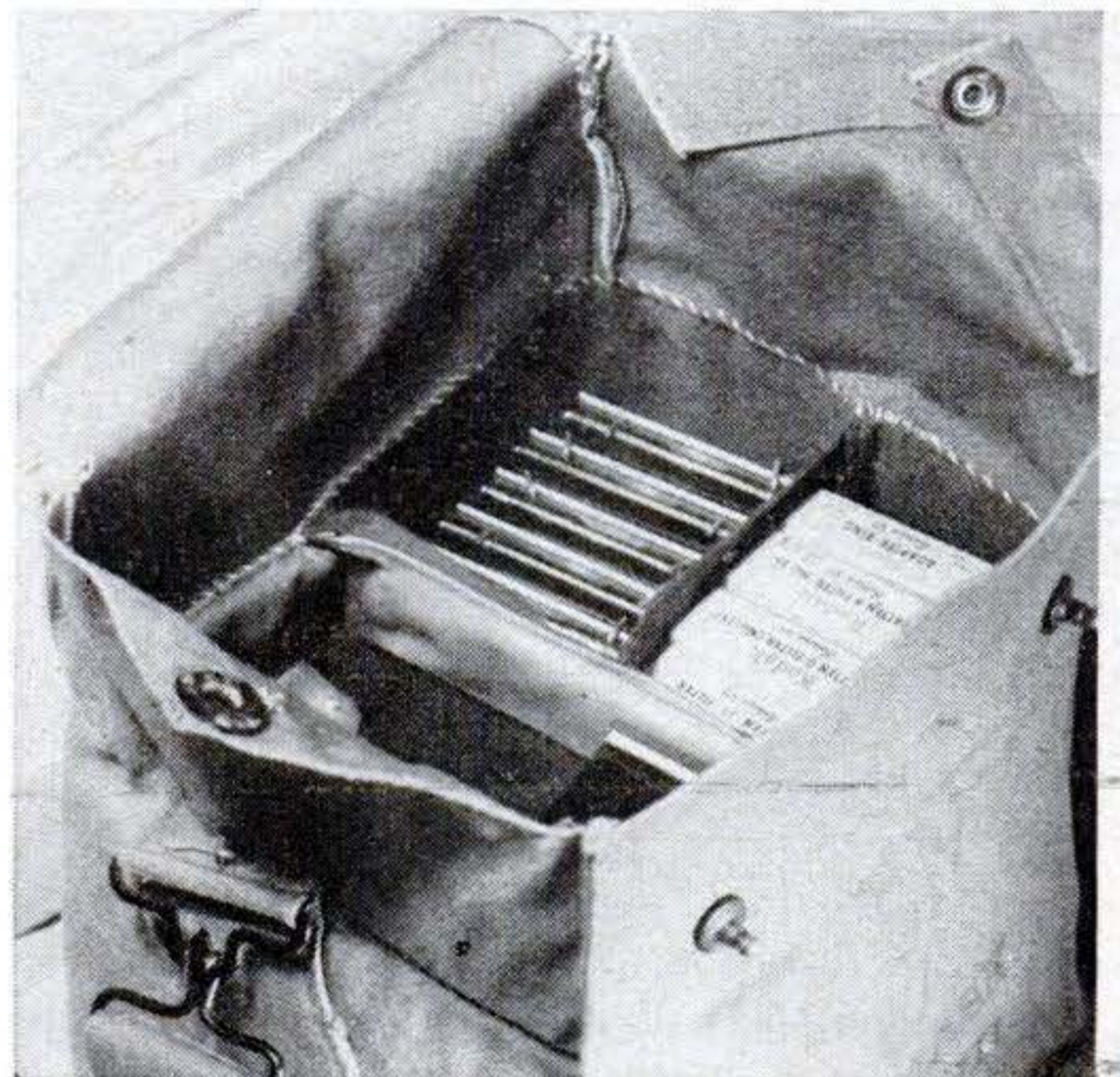

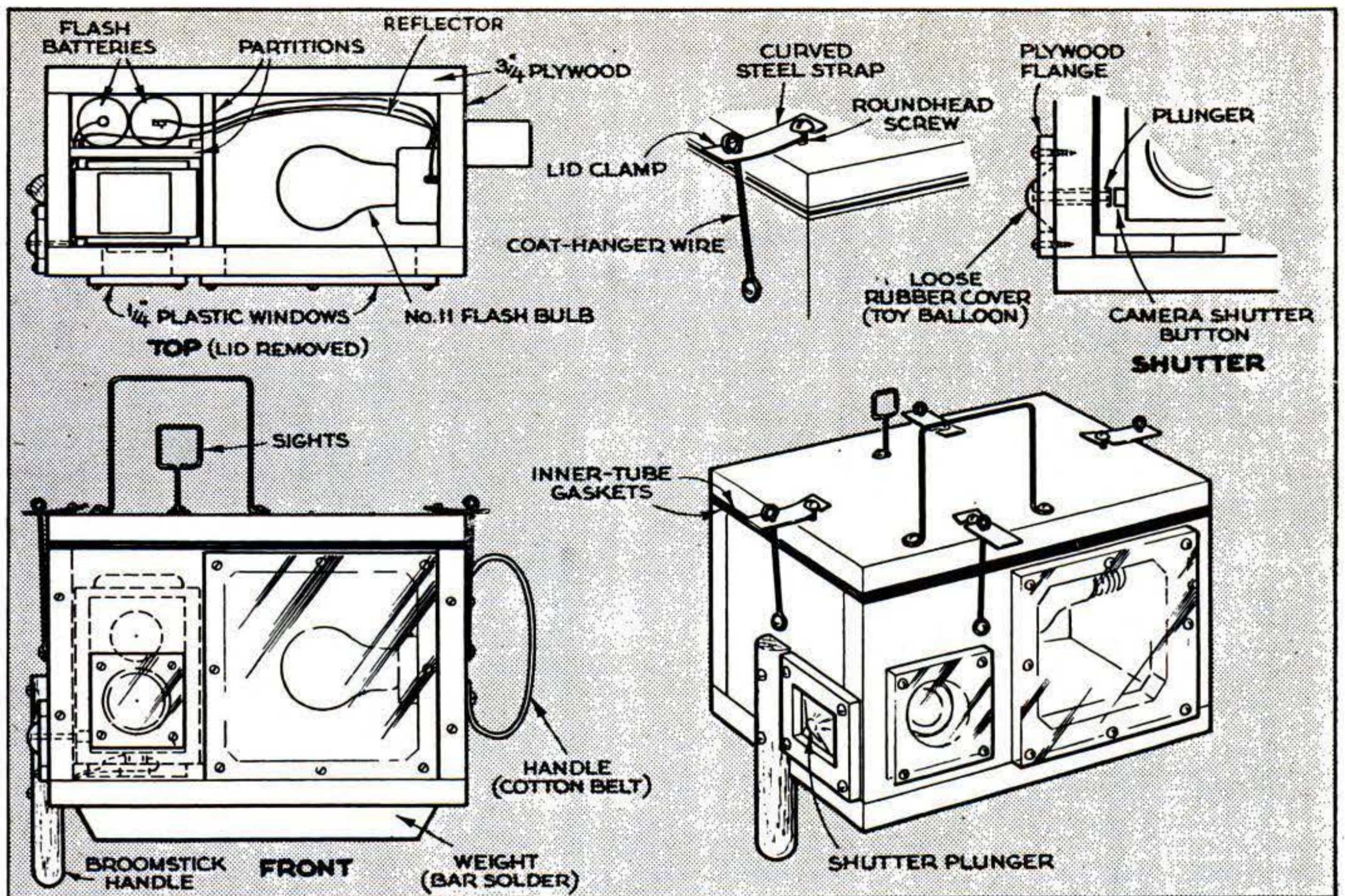

Safe inside a watertight box, the camera and flash are tripped by a rubber-sealed plunger.

Dive for Your Photos

SNAPSHOTS under water are easy, inexpensive, and fun. This outfit was built on a South Pacific island and used among the coral reefs in those wonderfully clear waters. You can borrow the idea for future use at your favorite swimming hole.

The equipment consists of a sturdy, watertight box of $\frac{3}{4}$ " outdoor plywood holding an inexpensive fixed-focus camera with synchronized flash. Melted tar was used on the joints and around the clear-plastic windows,

and the lid was fitted with a gasket cut from an old inner tube and bedded in tar. The shutter was tripped by pressing a plunger through a loose rubber diaphragm. Bar solder was attached to the bottom to neutralize almost all buoyancy. A partition in the box eliminates internal reflections.

Test the box thoroughly for watertightness, and then, armed with diving goggles, you'll be ready for a new kind of photography.—CHARLES E. DUNNING.



A swimmer poses for an underwater portrait. For such shots, a fixed-focus camera is best.



A small fish swims by. Fast film and a No. 11 bulb are quite effective up to 8' in clear water.

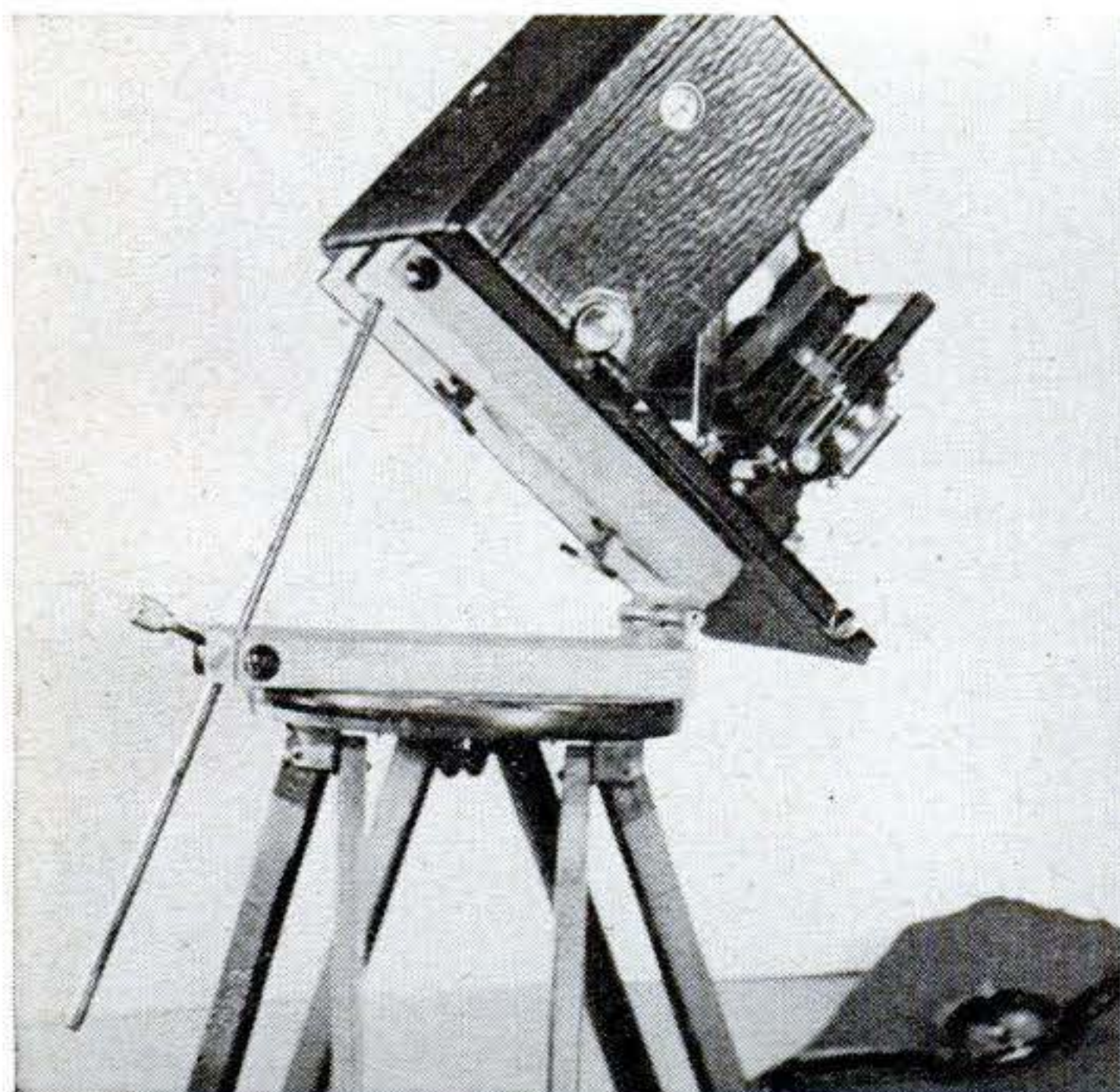
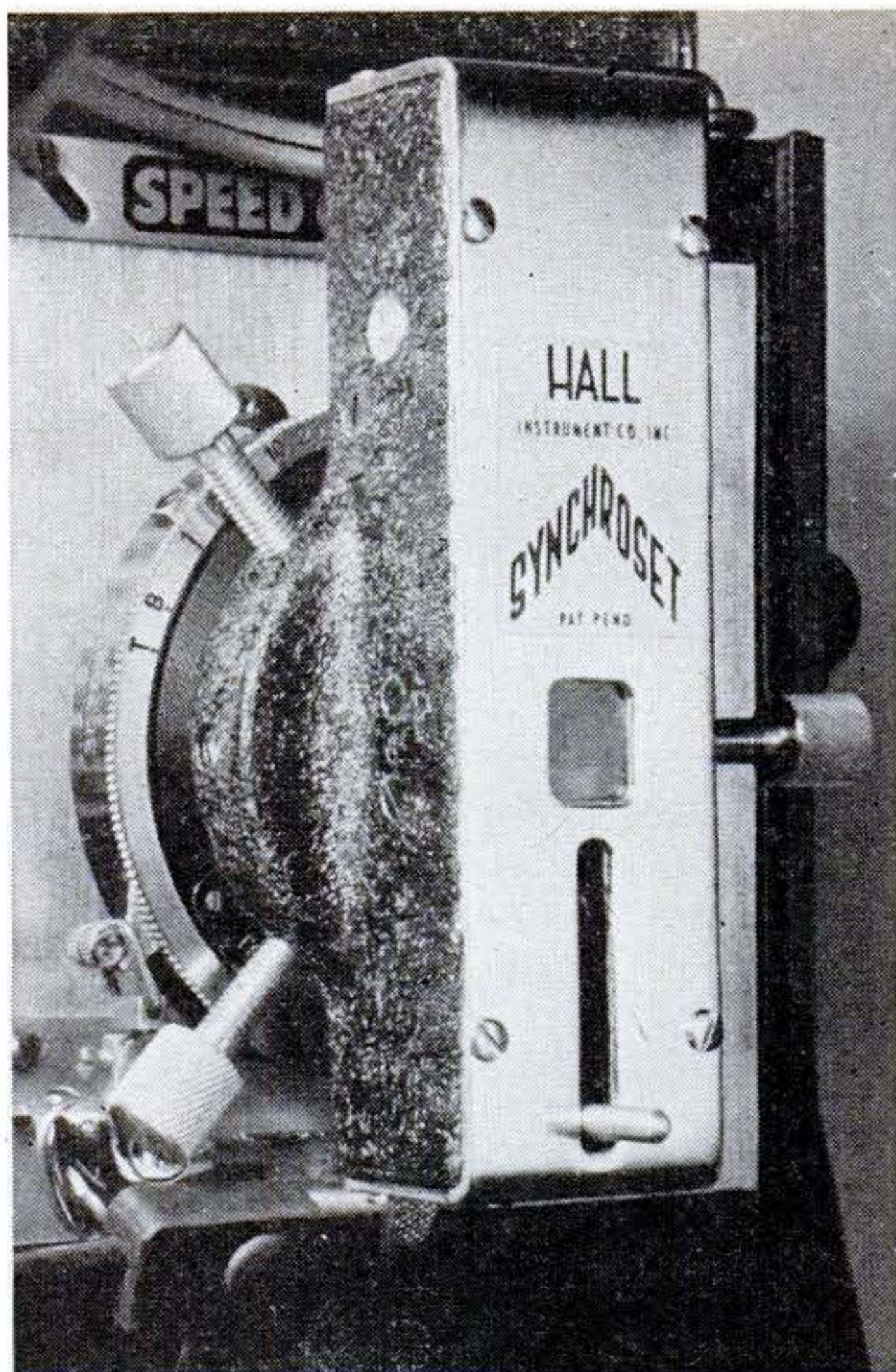

PHOTO IDEAS AND EQUIPMENT

Synchronizer Easily Checked.

An instrument made by Hall-Barkan Instruments, Inc., of Tuckahoe, N. Y., guides adjustment of solenoid synchronizers. The primary mechanism is an up-and-down slide containing a slit that moves in front of a lighted screen of equal width bands of red, yellow, and blue. If the operator, looking through the instrument toward a lamp behind the open back of the camera, sees all bands in full width when the shutter is tripped, there is perfect synchronization. If the top band is partly cut off, the shutter is late. If the bottom one is partly cut off, the shutter is early.

In use, the instrument is attached to the lens mount, the lens is set at infinity, the cocked shutter is set at the speed for which adjustment is desired, the synchronizer is connected to the battery and the instrument to the remote control outlet, and a cocking lever on the instrument is raised.



Head Tilts to 90 Deg. Locked by turning a setscrew against a 12" sliding rod, this tripod head tilts on a 3" butt hinge that is mounted to leave 1" space between the two $\frac{3}{4}$ " by $3\frac{1}{2}$ " by 6" wood members.

Slots 1" deep are centered in one end of the top and base for collars made from $\frac{3}{4}$ " lengths of $\frac{3}{4}$ " brass rod, and $\frac{1}{4}$ " holes are drilled edgewise across each piece for $\frac{1}{4}$ " stove bolts on which the collars pivot.

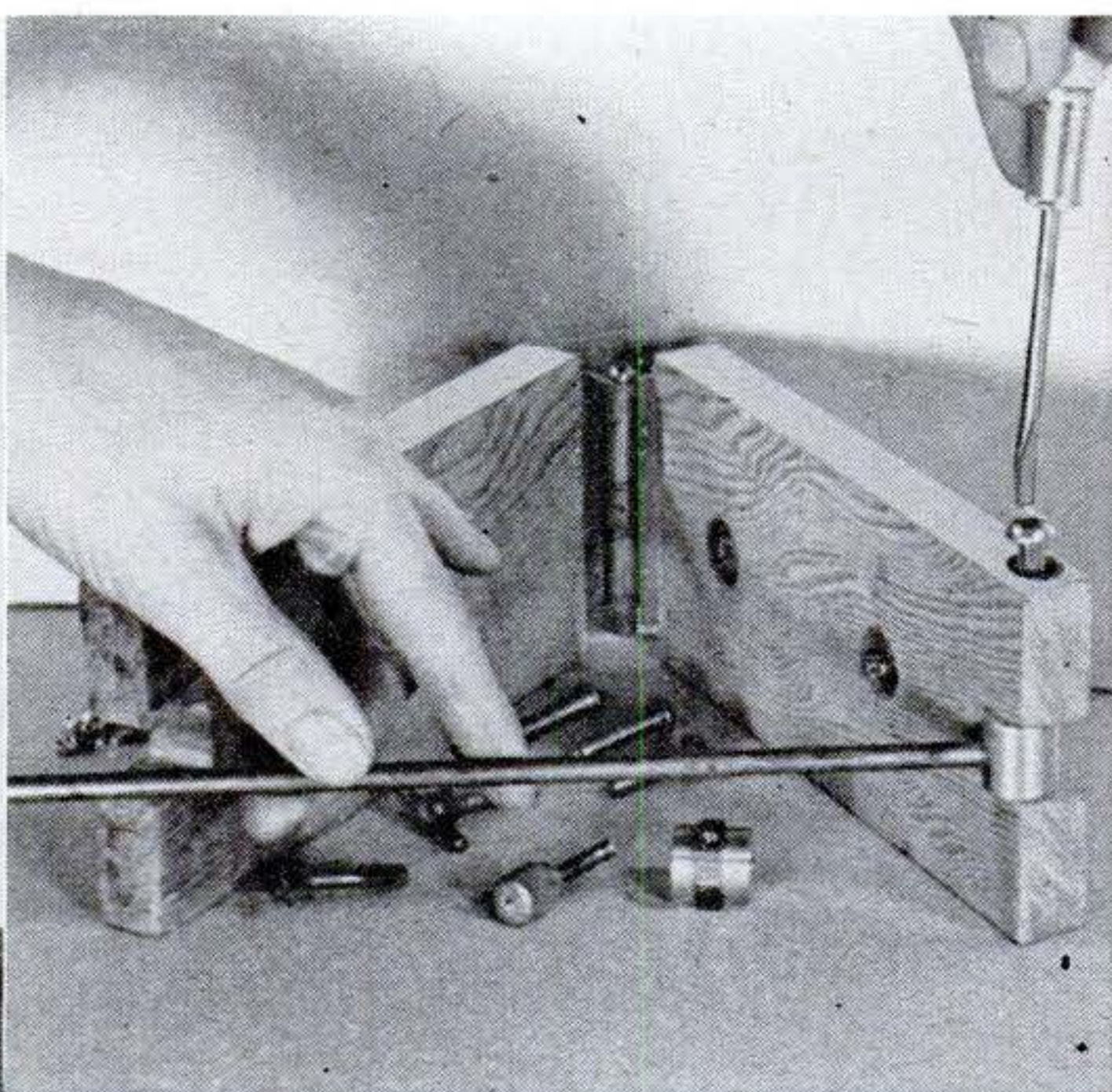

Drilled lengthwise, the collars are tapped for the stove bolts. One is drilled and tapped half through for the threaded end of the slide rod. The other is drilled so the rod may slide, then turned 90 deg., and drilled and tapped for the setscrew.

After $\frac{1}{4}$ " holes are drilled, $\frac{1}{4}$ " nuts are hammered flush against the inner face of the top and base for 1" wing bolts to attach the head and camera.—SAM C. DONALDSON.



Wallet Holds Filters. The plastic compartments of this wallet were designed to permit quick removal or insertion of filters without getting finger marks on them. Made of leather, it was introduced by Peerless Camera Stores, Inc., of New York, as part of a movie filter kit. The kit also includes a combination lens shade and holder.

Balance Pans Improvised. Even with good care, balance pans supplied with photographic scales often become pitted. As indicated in the photo at right, you probably have several good substitutes at hand. Two plastic saucers, filed until their weights are identical, are one possibility. Waxed cups are another.—DAVID H. THOMPSON.



Container Protects Brush. Mounted in an old lipstick case, this lens brush is always protected from dust. The outfit may be made by cutting the handle from a No. 10 or 12 camel's-hair brush, cleaning out the case, and attaching the brush with liquid solder. Let it harden well before using.—ERIC KARMINSKI, JR.

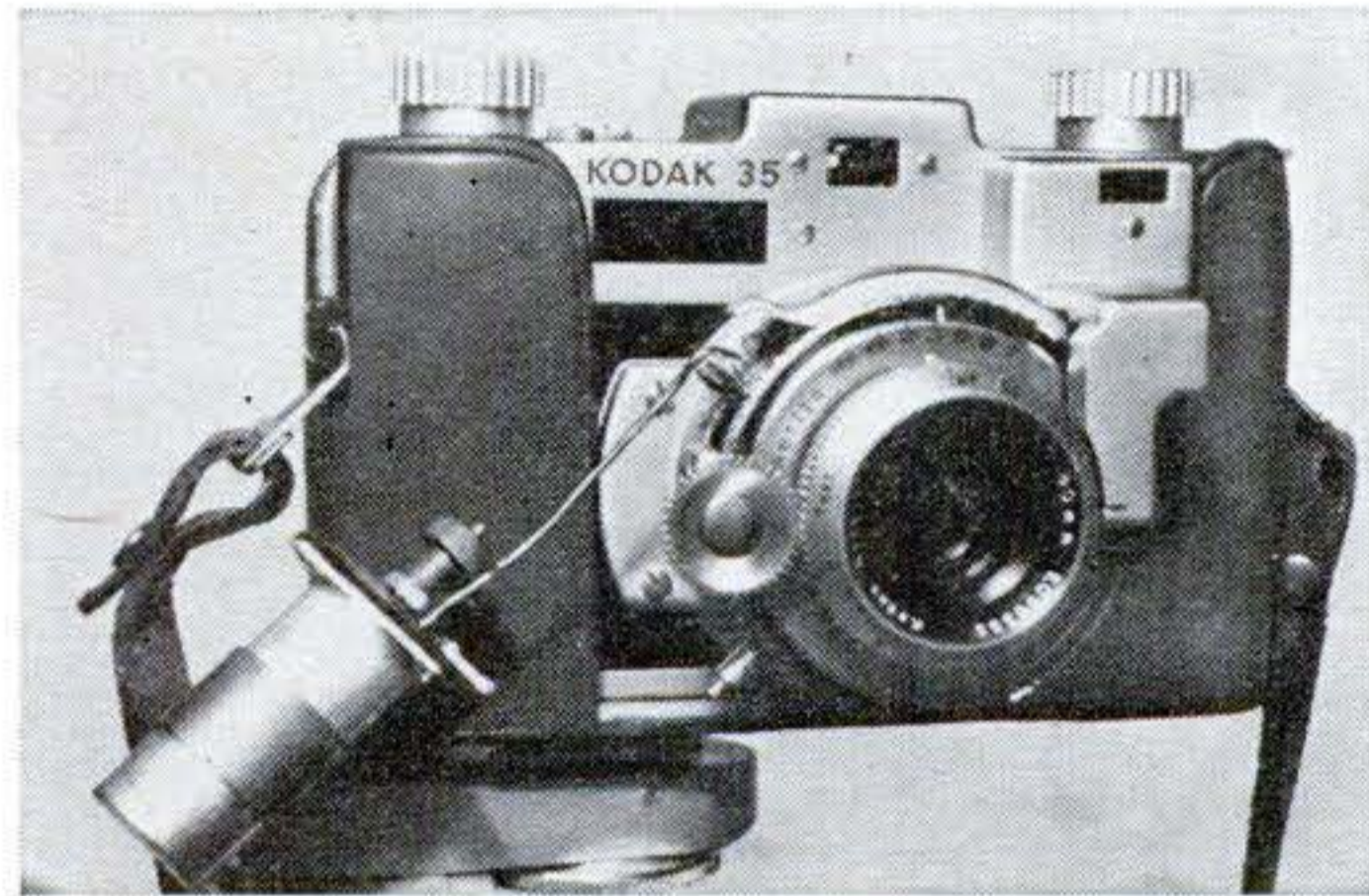

Timer Snaps You Too. If your camera is not equipped with one of the delayed-action devices that enables you to get into the picture, the situation may be remedied with one of the flight timers sold at model-airplane stores. Form a loop in one end of a piece of stiff wire and hook it over the shutter-release lever. Loop the other end around the plunger of the timer so that it will trip the shutter.—F. G. KNIGHT.

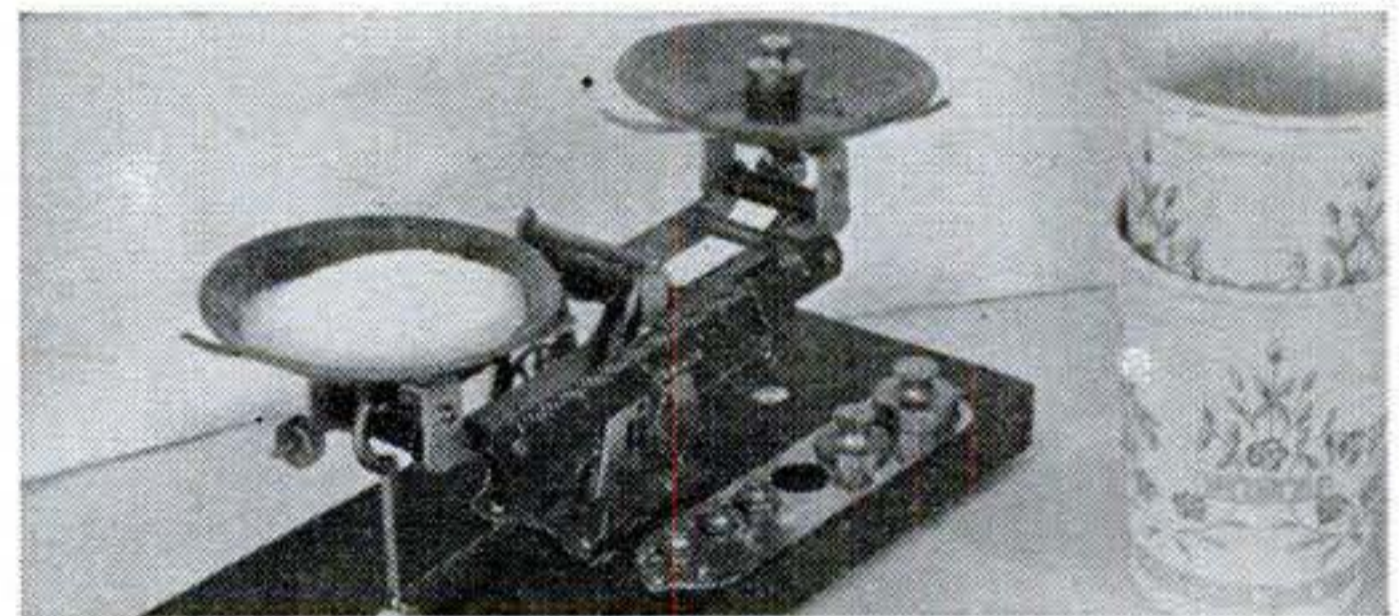

Blower Dries Roll Film. A small blower, a 75-watt lamp, two cans, and a few scraps of tin are used in this dryer. Located in the taller can, the lamp is wired in series with the 24-volt blower, thus both dropping the voltage and supplying some heat. An opening cut in the side of the film can admits warm air through a connecting tunnel, and an opposite hole discharges it. The can top is used.—R. B. GOODELL.

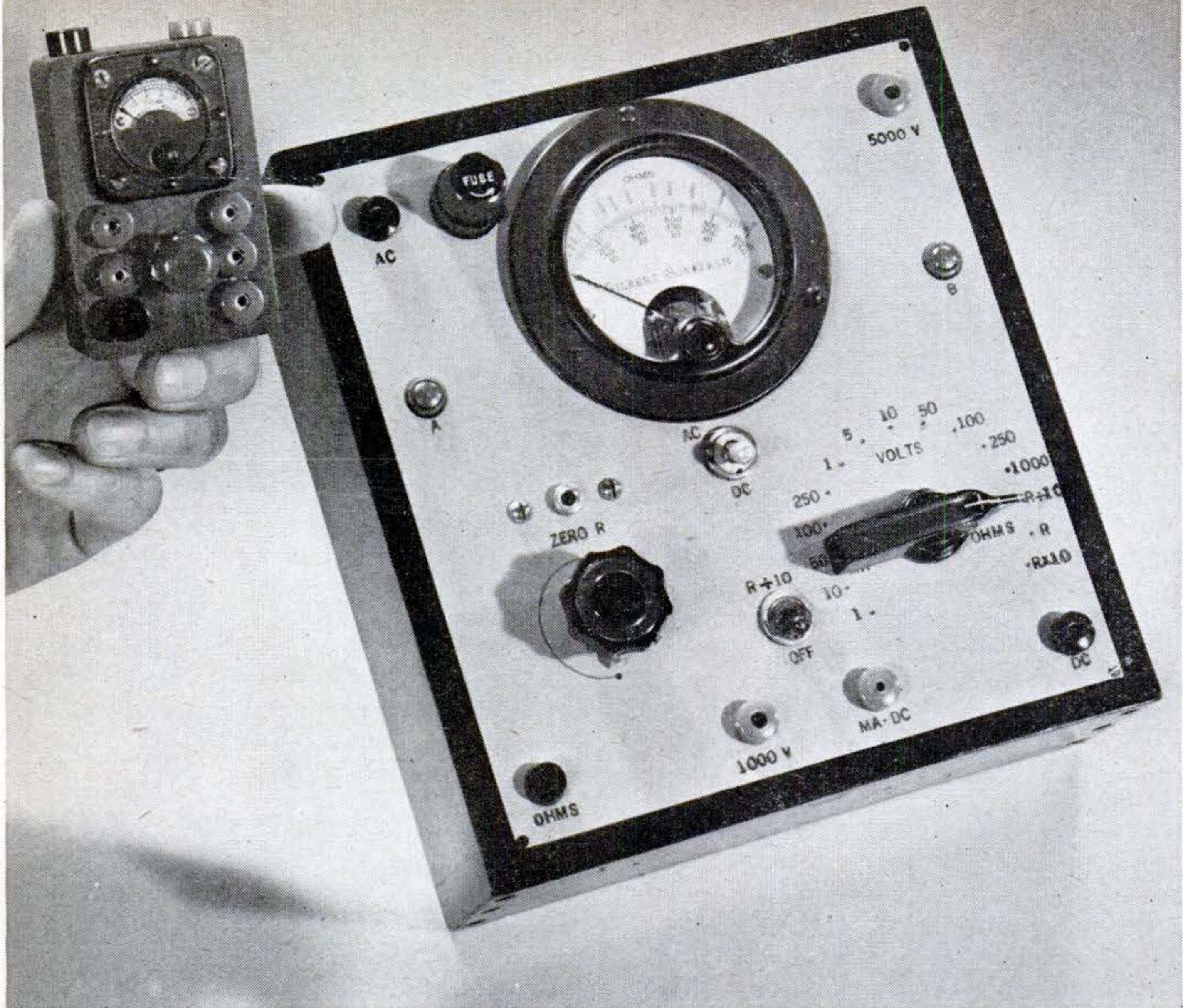

Bench instrument or pocket-size midget, a multimeter is a must in every electrical shop.

Completing Your Multimeter

If you built the tester described last month, you will want these further pointers on its use.

By Gilbert Sonbergh

PART THREE

SINCE all the essential information needed for building three types of multimeter was given in the two previous issues, you probably have your tester pretty well under construction. The two smaller units illustrated last month present no special problems. Most of this discussion, therefore, concerns the featured instrument.

It was stated that the range of a series ohmmeter cannot readily be lowered

enough to measure very small resistances. To do that a shunt ohmmeter was recommended. The principle of the shunt ohmmeter will be recognized as the same one used to determine the internal resistance of a meter with the aid of a known value of shunting resistor (Oct., p. 204). If we use a 0 to 1-ma. meter with internal resistance of 105 ohms, and shunt it with an equal resistor while energizing the circuit, a half-scale reading of 105 ohms results. Unlike series-ohms readings, infinite resistance is at full scale and zero is at zero on the dial.

A reading of 105 ohms center scale (higher if a fuse is used in the circuit) is not, however, sufficiently lower than the 450-ohm range to be of great value. In our

circuit, therefore, the meter and fuse are shunted to read 10 ma. in order to provide a center-scale reading of 11.4 ohms. Switch positions are the same as for the lowest series-ohms range, but a test lead is used to short the DC and OHMS terminals. The unknown resistor is then inserted between this jumper and MA-DC. Since accuracy is dependent primarily upon current value, rheostat R16 is turned to "off" position, and current is regulated to full scale—precisely 10 ma.—by R17. This is being done by the screwdriver adjustment illustrated at the upper right.

The resistor under test then shunts the whole circuit, and its value may be calculated from formula 8 (Oct., p. 204). It must be remembered that this formula is only an approximation, and its accuracy decreases as the circuit current is raised. The graph at the right was plotted by calculating a number of points from a more exact formula, and it should hold reasonably well for any meter constructed with the same values as the ones shown.

If the graph should prove inaccurate for your meter, you can plot another one with the help of a few feet of resistance or fine-copper wire. Measure a dozen or so lengths of wire and calculate the resistance of each from the ohms-per-foot rating of the wire. Then check the wire on the meter and plot scale deflection against known ohmic value. Shunt ohms are represented by the numbers in the left hand margin of the graph; a companion curve for a series ohmmeter crosses it from upper left to lower right and is read against the figures in the right-hand column. The chart is drawn on logarithmically scaled paper, available at most stationers.

As has been pointed out, the reason that ohmmeters are peaked at center scale is that all ranges cover the area from zero to infinity, and therefore both ends of the scale are bound to be inaccurate. The problem of measuring low resistances may be met by the shunt ohmmeter. But what about very high ohmic values? Of what use is a meter that reads, say, 90,000 ohms when you want to measure a resistance of several megohms? The answer seems to be that you can't make these measurements, but in fact the problem is easily solved. All you need is a voltmeter and a source of high voltage, such as the power-supply circuit of an AC receiver.

Measure this voltage—preferably several hundred volts—and then make a second

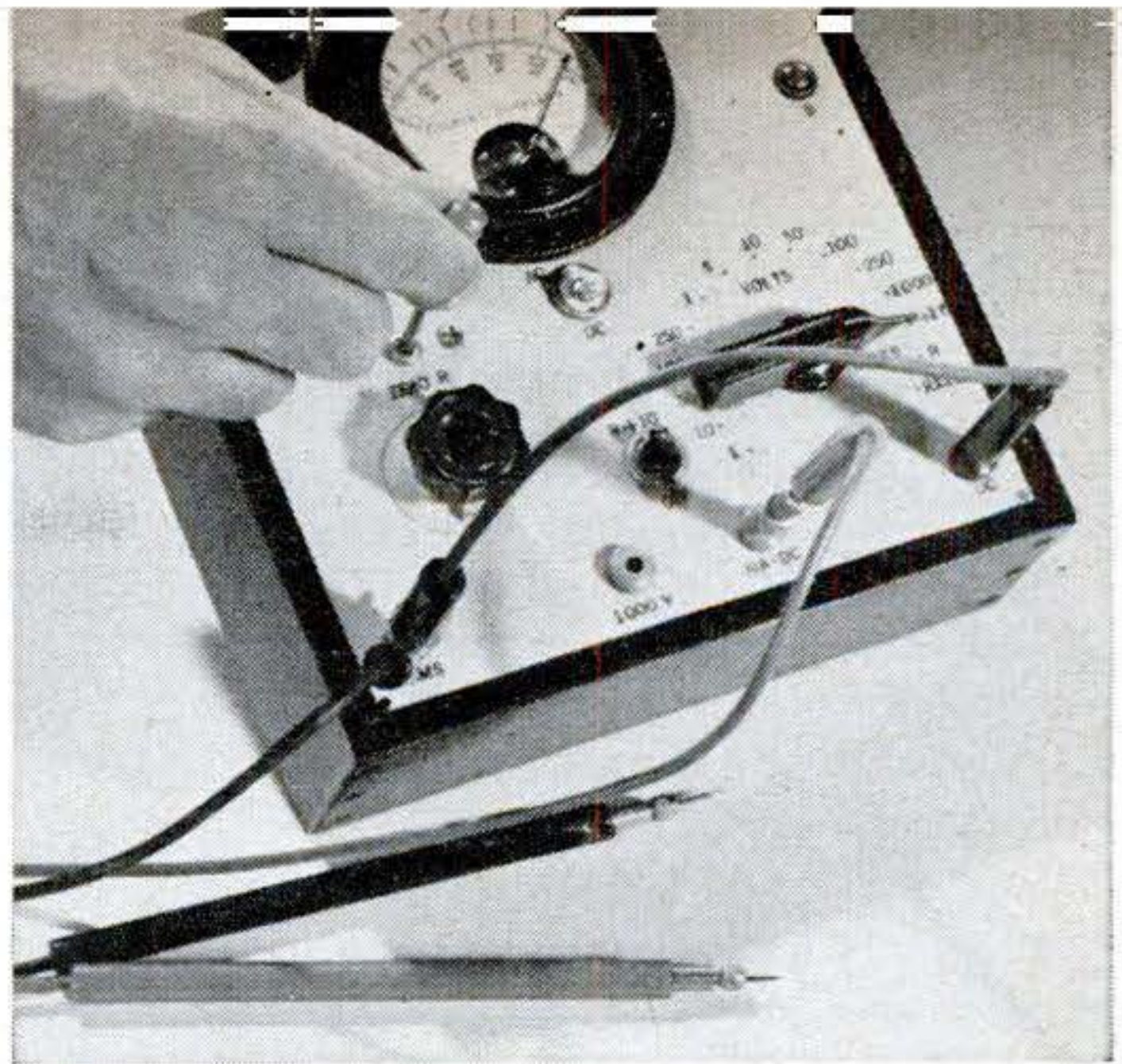

Adjusting the meter to read on the lowest ohm range. Scale divisions are graphed as below.

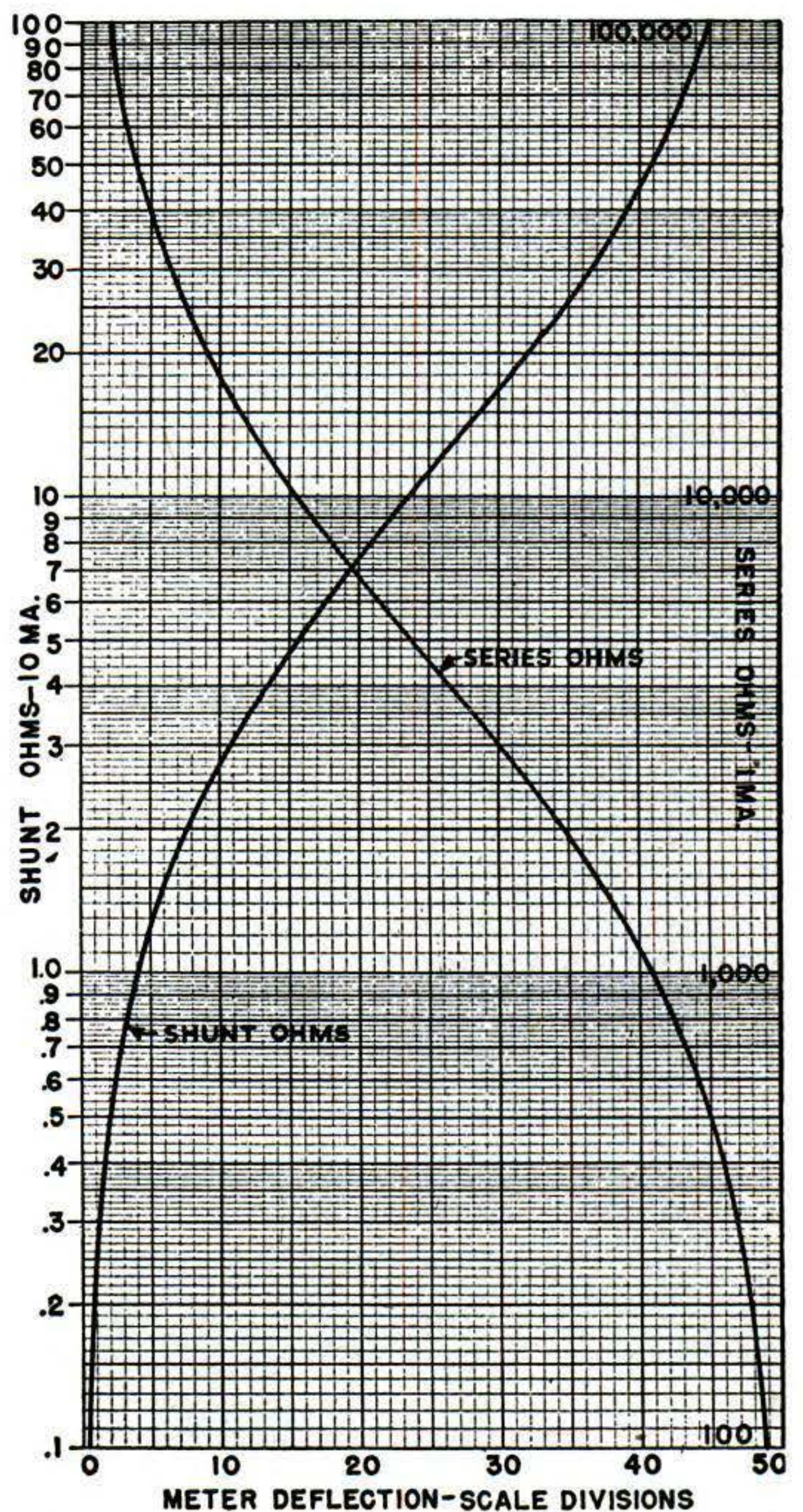

A graph of this type will help you interpret nonlinear shunt and series ohmmeter readings. It should hold for meters built like the one above, or it can be plotted from known values.

reading with the unknown resistor in series with the meter. The unknown value may then be calculated from formula 9, below.

Your AC voltmeter may also be used to measure capacitance, inductance, and impedance with sufficient accuracy for most purposes. An AC power line will serve very well, provided that you take adequate precautions to prevent electrocution. First measure the line voltage; then take a second reading with the unknown element in series with the voltmeter.

Capacitance of condensers is figured from formula 10. Again it may be wise—if any considerable number of readings is to be made—to draw a logarithmic graph in which the voltage readings of your meter are plotted against capacitance. The graph will be useful wherever the same meter is used on the same line voltage. Use a dozen or so accurately known condensers to plot this graph. Capacitance measurements may be multiplied by ten or a hundred if the voltmeter leads are shunted by suitable resistors to reduce the effective voltmeter resistance (R_v in the formula) to a tenth or a hundredth of its normal value. Alternatively the high ranges may be obtained by using a stepdown transformer (and a lower voltmeter range) to reduce the values of E_m and E_l .

Inductance is calculated approximately from formula 11. A graph of inductance values against meter readings would be accurate only for high "Q" inductances—those

in which DC resistance is small compared to AC inductive reactance.

Impedance is expressed in ohms, and is the tendency of capacitors or inductors to resist the flow of alternating current of any given frequency. When needed, the impedance of a coil or condenser may be obtained with the help of formula 12.

An AC rectifier-type voltmeter makes an excellent output meter for receiver alignment, power-output measurements, measurements of gains or losses of amplifiers, and the like; it may be calibrated in volts or decibels. If any direct current is present in the circuit under test, it should be kept from the meter by a good quality paper condenser of from .5 to 2 mfd. The AC component or "ripple voltage" of power supplies is measured in this manner.

If your meter is built according to all the specifications given in the previous installment, the face of the instrument, including switches and test jacks, will probably resemble that of the larger unit shown on page 204. To read DC milliamperes, then, insert test leads into the DC and MA-DC pin jacks. Note that a narrow pin and adapter is shown in the photos for the latter jack. This is used to lessen the possibility of applying a high voltage to the milliammeter by accident. When making current measurements, always start out with the selector switch indexed to the highest range and back down until an accurate reading can be made. Insertion of a milliammeter into a circuit that

FORMULAS FOR MULTIMETERS [ELECTRICITY]

To Use Voltmeter as Ohmmeter

$$(9) \quad R = \frac{E_b R_s}{E_m} - R_s$$

AC Voltmeter as Capacitance Meter

$$(10) \quad C = \frac{E_m}{2\pi f R_v \sqrt{E_l^2 - E_m^2}}$$

AC Voltmeter as Inductance Meter

$$(11) \quad L = \frac{R_v \sqrt{E_l^2 - E_m^2}}{2\pi f E_m}$$

AC Voltmeter as Impedance Meter

$$(12) \quad Z = \frac{R_v \sqrt{E_l^2 - E_m^2}}{E_m}$$

where R_s is total fixed resistance in meter circuit.
 E_b is battery or power-supply voltage.
 E_m is reduced voltage reading during test.

C is unknown capacitance (in microfarads).
 E_l is full voltage of AC line.
 f is AC frequency ($2\pi f = 377$ on 60 cycles).
 R_v is total voltmeter resistance (in megohms).

L is unknown inductance in henrys.
 R_v is total voltmeter resistance in ohms.

Z is unknown impedance in ohms (may be capacitive or inductive).

POPULAR SCIENCE MONTHLY SHOP DATA

has low resistance and high current will cause a change in the normal current flow. Such measurements should therefore be made on the highest range that will still provide a readable pointer deflection. For greatest accuracy on DC current and voltage ranges, turn R16 to its "off" position in order to keep the 10,000-ohm rheostat from shunting the meter.

Voltages are read by inserting the test leads into the DC (or AC) and 1,000-volt

jacks. The AC-DC switch is also thrown to correspond to the character of the voltage being measured. Index the selector to the appropriate range. When measuring voltages in excess of 1,000, move the test lead from the 1,000 to the 5,000-volt jack, and leave the selector on 1,000. Exercise caution when measuring high voltages. One good practice is to keep one hand in your pocket and perform all necessary manipulations with the other. **END**

Midget Volt - Ohmmeter

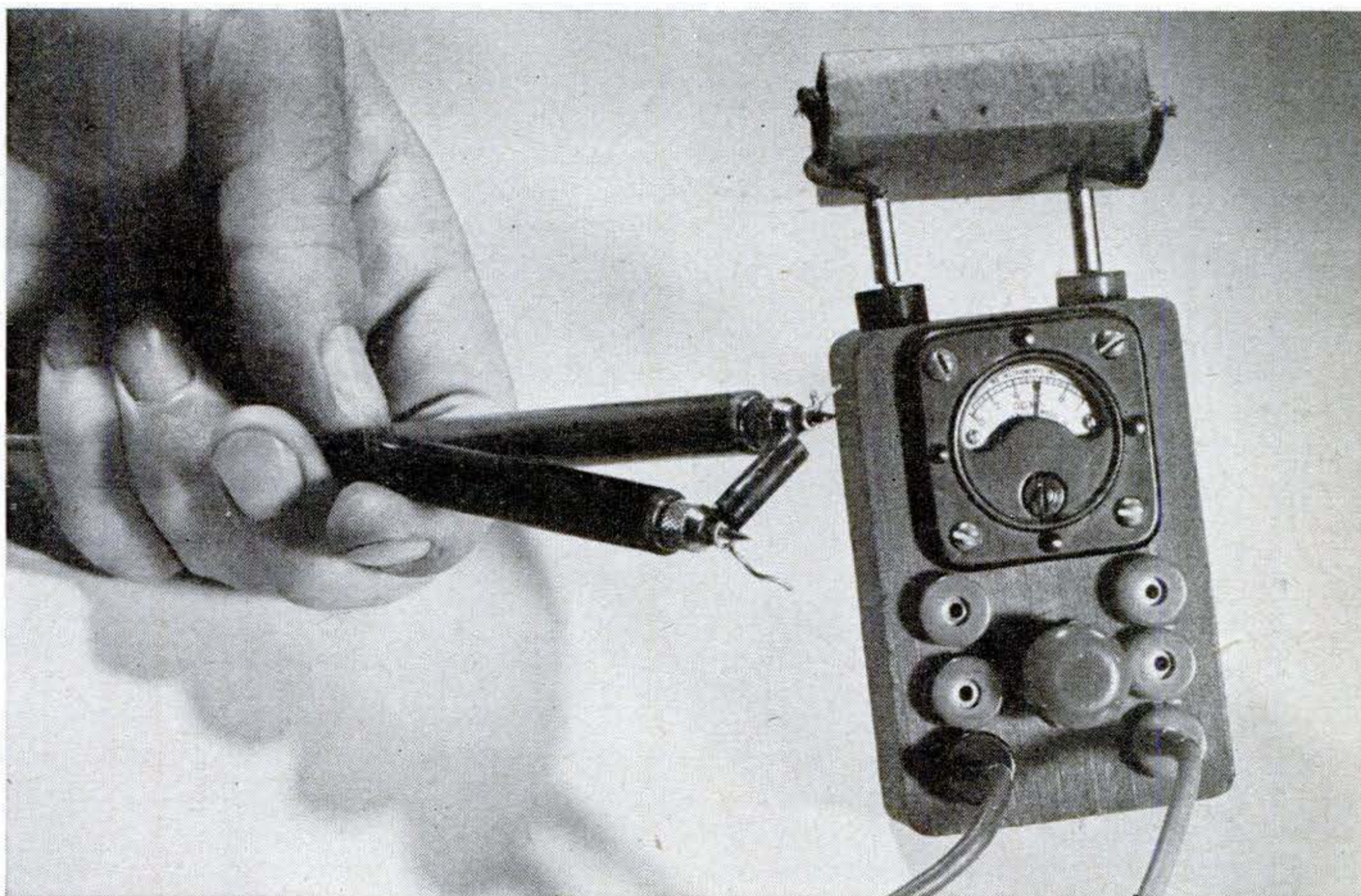

With external battery the pocket-size tester measures two ranges of resistance. Three pen-

light cells in series, wrapped in cardboard or cellulose tape, make a compact voltage source.

WHETHER or not you have built, bought, or borrowed a general-purpose multimeter, you will find a place in your electronic tool kit for a midget meter that measures the things you most frequently need to know. If you are a beginner, building it will teach you the principles and uses of multimeters; if you are an experimenter or service man you will find unlimited applications for an auxiliary, pocket-sized instrument both in and out of the shop.

Compact as the meter is, all the components are standard. When buying the resistors or selecting them from your spare-

parts box, you will want to check them for accuracy on a reliable ohmmeter. All resistors are connected in series with the positive side of the midget meter.

The meter itself, a 0 to 1-ma. unit with internal resistance of approximately 25 ohms, is of the type developed during the war for use in aircraft equipment. It measures only 1" in diameter and has a mounting flange 1 3/8" square. Together with all the auxiliary parts, it is built into a 1" by 2" by 3" wooden box. Near the top of the box panel, drill a hole slightly over 1" in diameter. Aside from the meter, six phone-

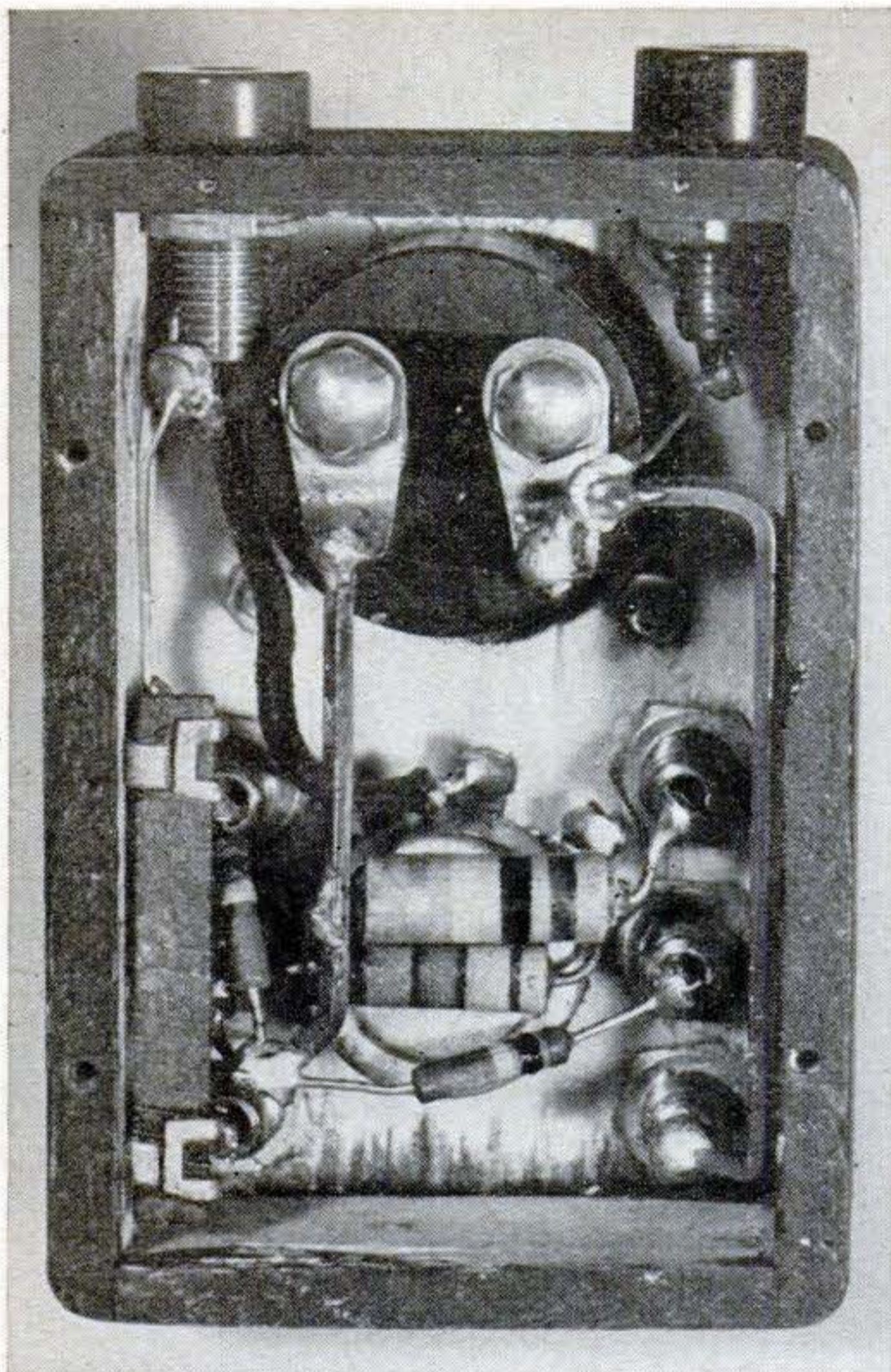

Even inside the 1" by 2" by 3" case, there is plenty of room for the handful of components.

tip jacks and a midget 25,000-ohm rheostat are mounted on the face. In the edge of the box above the meter place two more jacks for the external battery. This will be in series with the rheostat and a 3,000-ohm fixed resistor.

For both the low and medium-ohms ranges an external battery is required. Use a 4½-volt supply; three pen-light cells in series are suggested because they will not add very much to the size and weight of the equipment.

The five scales chosen offer a wide variety of uses in radio servicing. The 0 to 10 and 0 to 100-volt ranges will enable you to check all sizes of A and B batteries, and the 0 to 500-volt scale will come in handy when you want to know the potential across the plate or screen of most receiver tubes.

Each of the ohms ranges has its own particular advantage. All antenna, RF, and IF coil windings, as well as filter chokes and power transformers, can be tested on the low scale, and this range is also useful as a continuity tester. By touching the two prods to the heater pins on a tube, you can deter-

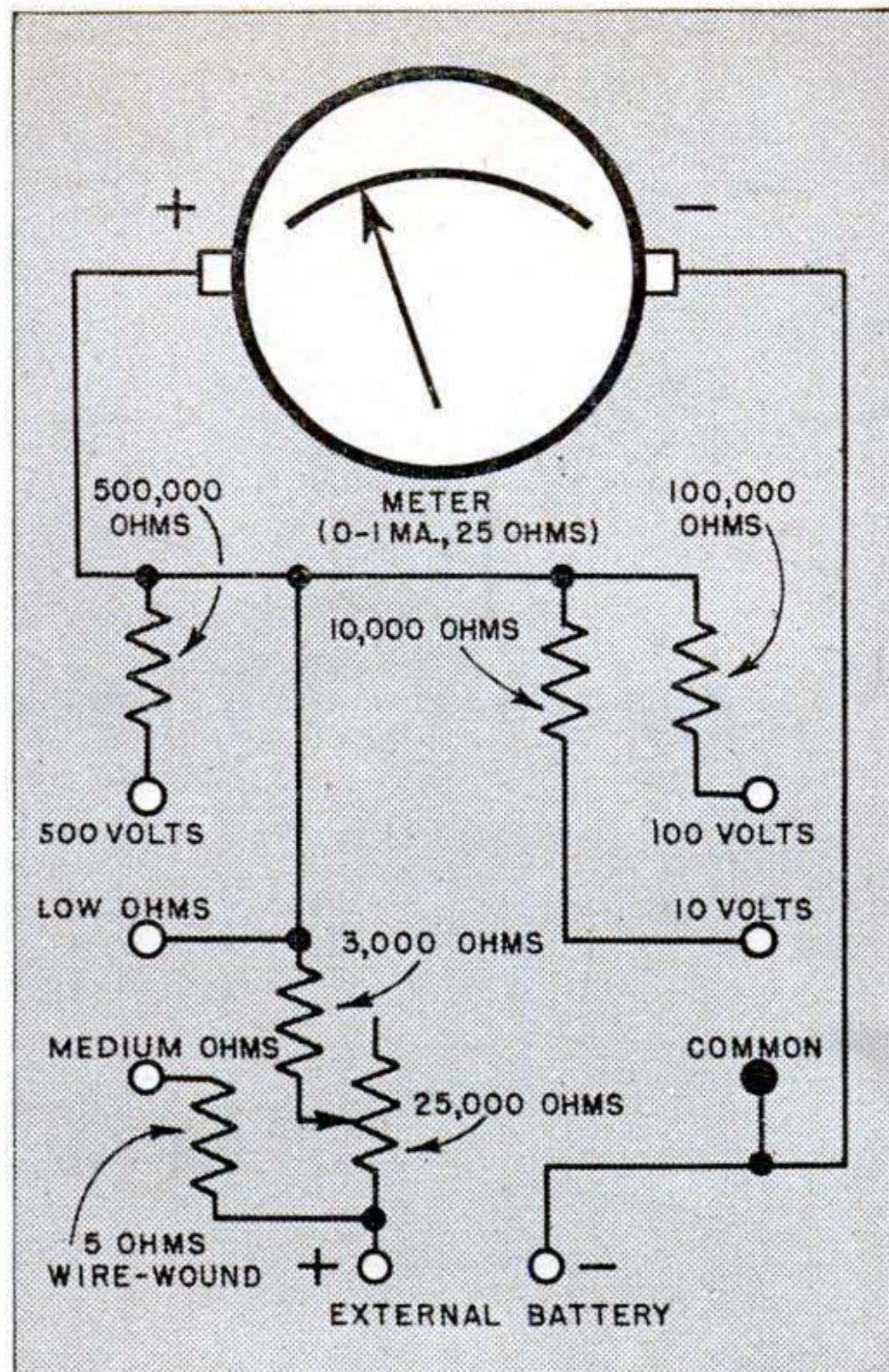

In most respects placement of the parts can follow the layout shown in the diagram above.

mine whether the filament is open. If it is, there will be no deflection of the needle. About 80 percent of set failures can be traced to burned-out tubes, and in AC-DC receivers, where tubes are connected in series, it is impossible to tell which is causing the trouble unless the filaments can be checked.

With the medium-ohm meter you can tell whether the high-resistance windings of such parts as high-impedance chokes, output and audio transformers are open or shorted. Higher resistors, such as may be found in plate, screen, or coupling circuits, can't be measured directly, but defects can easily be spotted by checking the voltage reaching the tubes. Both ohms scales can be used to detect shorts in paper-tubular condensers and leakage in electrolytics.

You can read volts directly by multiplying scale markings by 10, 100, or 500, depending upon range. The ohmmeter is for service checking rather than for accurate measurement. To get approximate values, measure a dozen known resistors and graph pointer positions.—ALBERT ROWLEY.

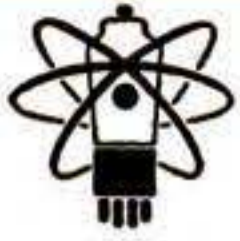

NEWS IN ELECTRONICS



Sockets Grip Miniature Tubes.

The wire prongs of miniature tubes frequently slide out of their sockets or make intermittent contact. A remedy is offered by A. W. Franklin Mfg. Corp., New York, in the sockets shown above. Metal eyelets converge around the pins to assure positive, constant contact.



Device Calibrates Voltage. When connected to any oscilloscope, this new Du Mont instrument provides a convenient method for measuring peak-to-peak value of any signal. It generates a square wave which is continuously variable from 0 to 100 volts and which may be directly compared with any signal being viewed.

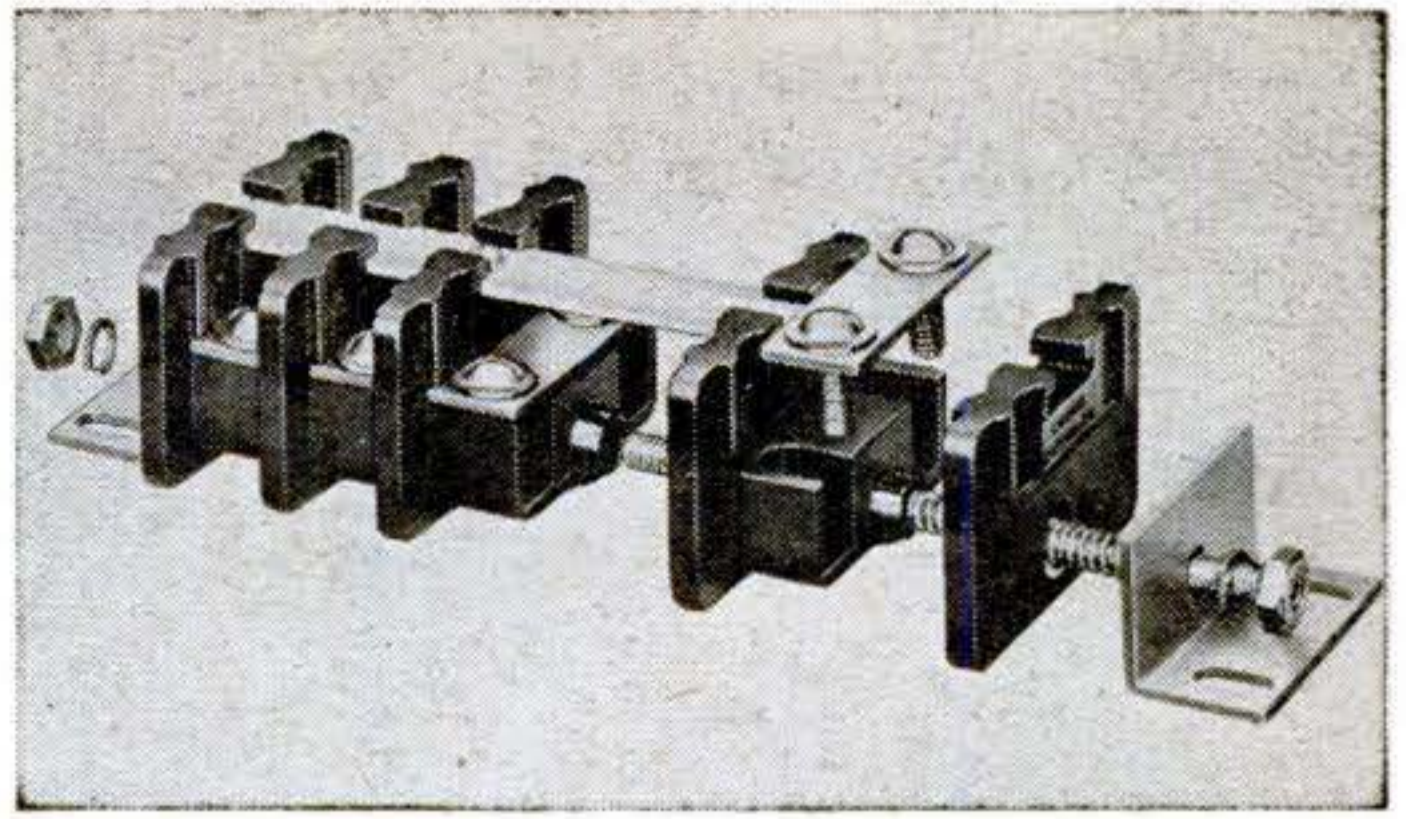

Add Terminals as Needed. Experimenters can give hand-made equipment a more finished look and make wiring easier by building up terminal blocks from kits produced by the Curtis Development & Manufacturing Company, Milwaukee. From one to 14 terminals can be assembled in one strip from the parts furnished in the kit.

Parts Shrink.

Subminiature tubes are now matched in size by midget capacitors manufactured by Tobe Deutschmann Corporation, Canton, Mass. The paper-dielectric condensers are molded in wafer-shaped phenolic cases to suit the closely stacked assembly of miniature apparatus.

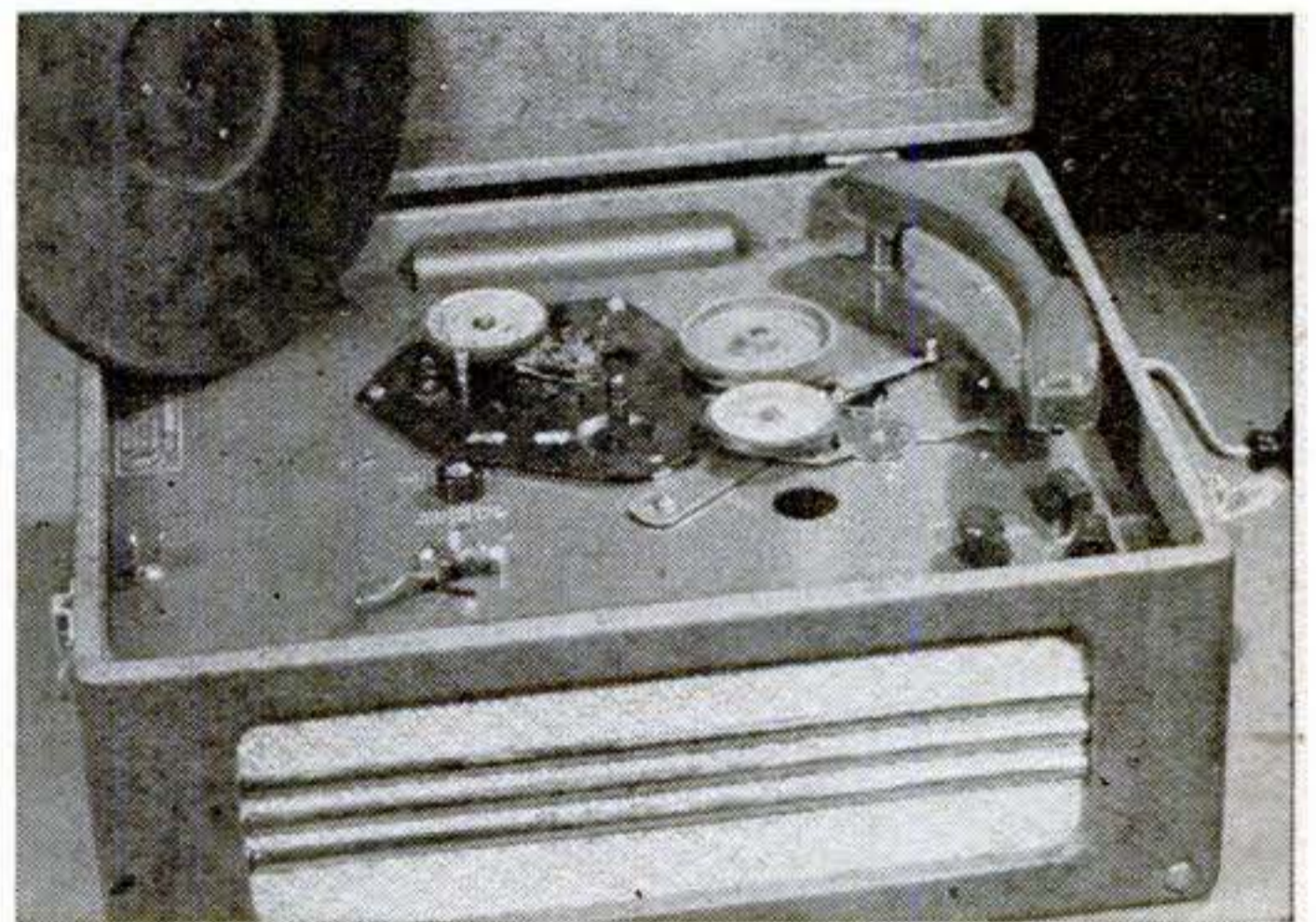
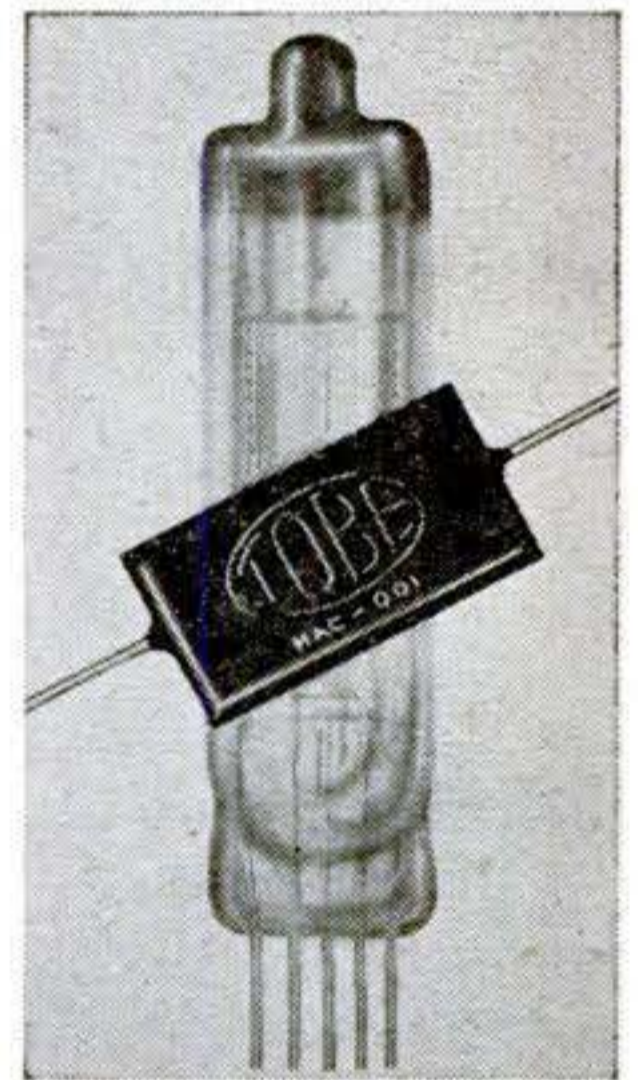

Phono Runs on Spring or AC.

One drawback to the production of AC-DC-battery phonograph portables has been the lack of motors that would operate anywhere. Capitol Records, Inc., of Hollywood, combines an AC motor and a spring-drive mechanism with a three-way amplifier to get a truly portable record player.

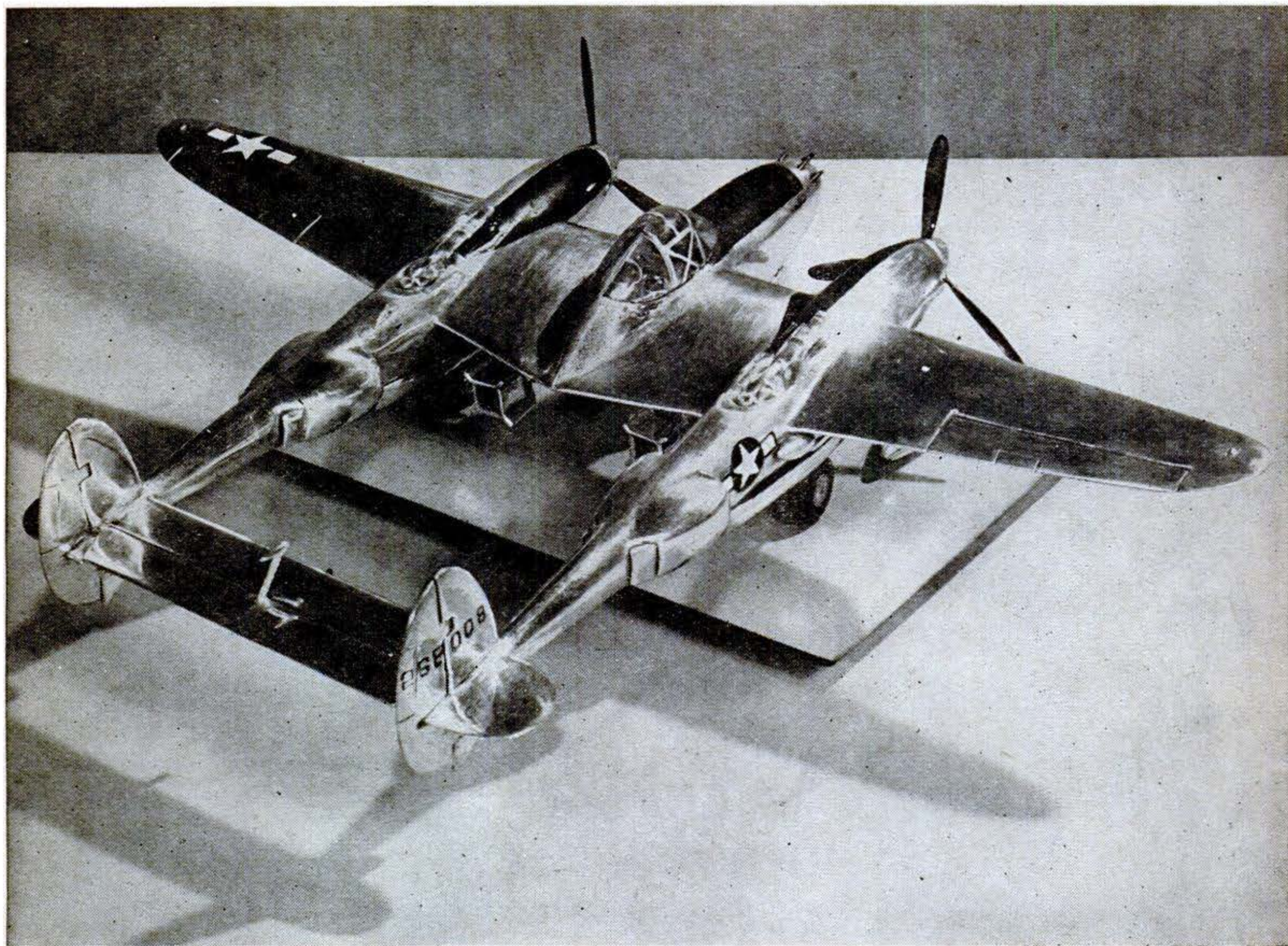

This gleaming P-38 was produced by silverplating a conventionally built balsawood model.

How to Silverplate

By Whiting Evans

PROJECTS executed in wood, plaster, plastics, or ceramics can be permanently encased in a resplendent metallic sheath that will greatly enhance their beauty.

You'll need a plating tank big enough to handle your work. Calculate tank size by allowing at least 6" from the object to be plated to the anodes, and at least 1" from the anodes to the tank sides. But don't go overboard on tank size unless you're prepared to mix up solutions in big quantities. (My P-38 model shown would have required a 30-gal. tank if I had plated it all at once, but by sawing it in half, I did it in a tank measuring 10" by 15" by 20".) If you wish to build your tank, it can be made of wood lined with either sheet lead or sheet rubber. Perhaps you can pick up a

glass storage-battery tank or a rectangular goldfish aquarium of suitable size. A big crock of glazed earthenware will also do.

As best results in plating are achieved by constant agitation of the electrolyte, it's desirable to feed air through a perforated pipe on the bottom of the tank. Small holes drilled every 3" or so in a plugged lead pipe will do the job, or rubber tubing weighted down with wire solder could be used. To keep even a drop of oil from the compressor from contaminating the electrolyte, provide an oil trap on the air-input line. This need only be a soup can packed with clean, dry cotton. If you don't have a compressor, any source of low-pressure, low-volume air will do, even a toy steam engine run backward by a small electric motor.

Plating requires a regulated source of low-voltage DC. You may wish to use a

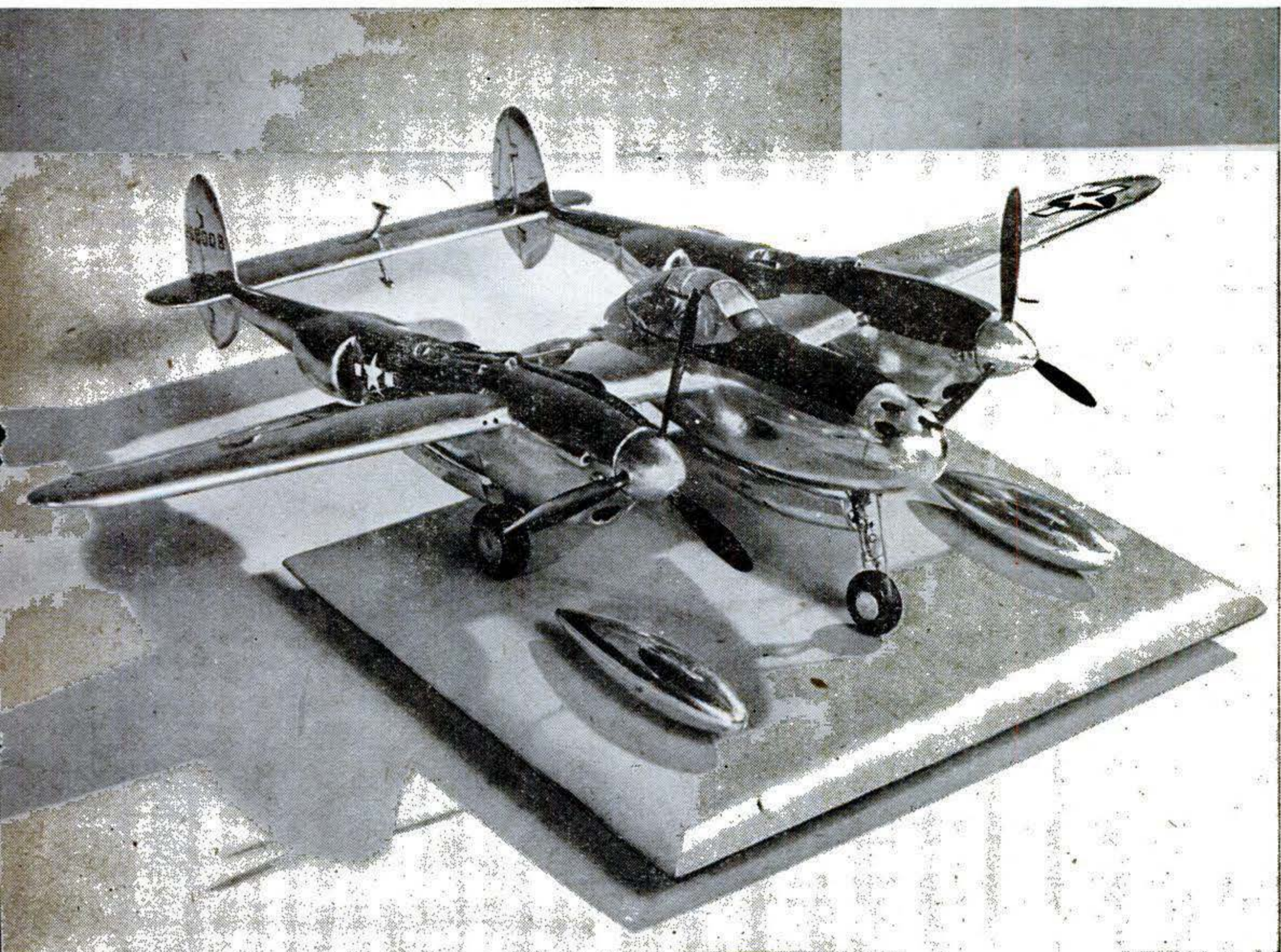

Silverplating is an especially appropriate finish for display models of aluminum aircraft.

Wood

storage battery and rheostat, a battery charger, or a transformer-rectifier unit of the sort used with modern model trains. Perhaps the most flexible rig is the one illustrated, in which a shop motor drives an old auto generator, with a storage battery "floating" across the line to limit voltage. A fairly good voltmeter is a must, and an ammeter handy but not as important. If you don't have a suitable rheostat, use some nichrome wire of the sort supplied as a replacement element for a toaster or electric iron. One lead is connected to the end of the nichrome wire and the other is clipped on as far along as is necessary to get the right resistance.

Be sure that the finish of your project is as perfect as you can make it. Remember that any flaws in the surface will be more conspicuous in the polished metal plating. The plane model shown was carefully lac-

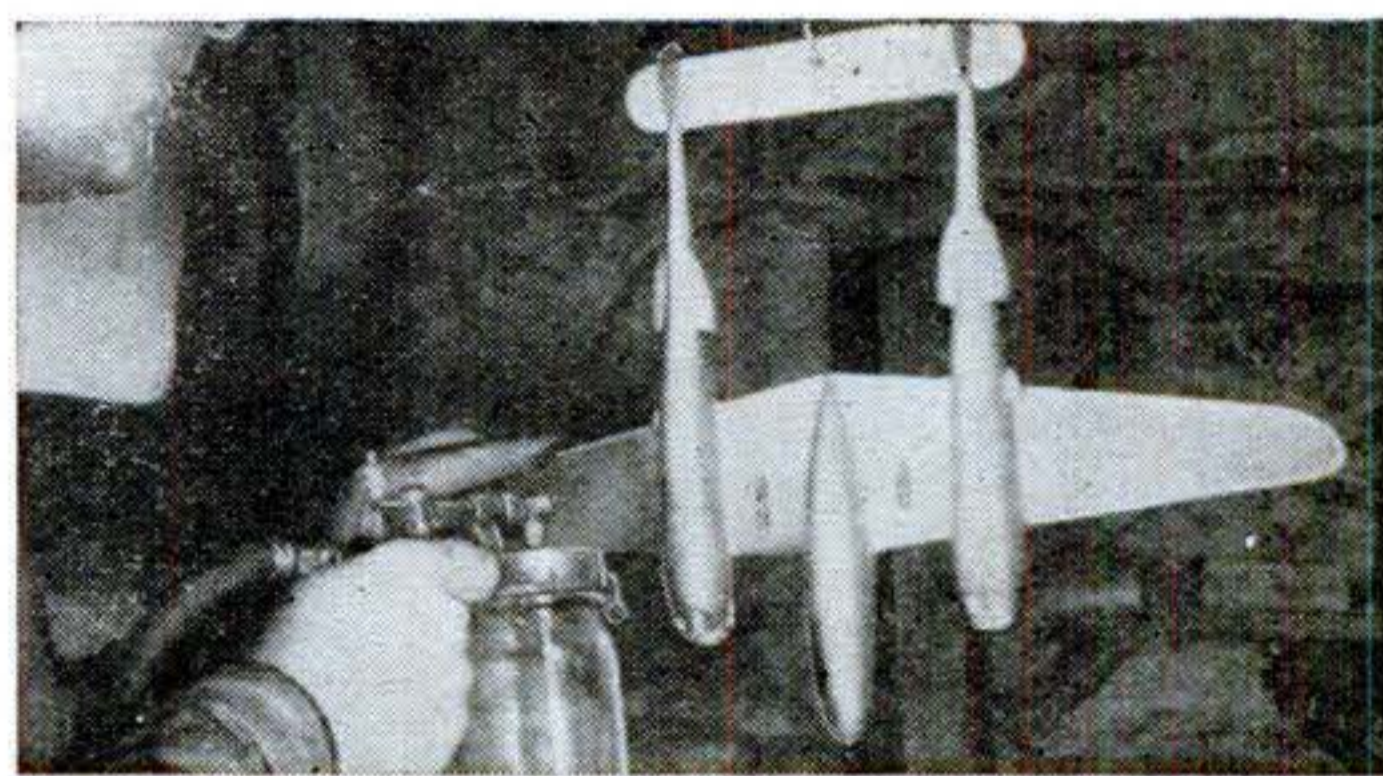

Powdered metal and lacquer are sprayed on the work so as to make it electrically conductive.

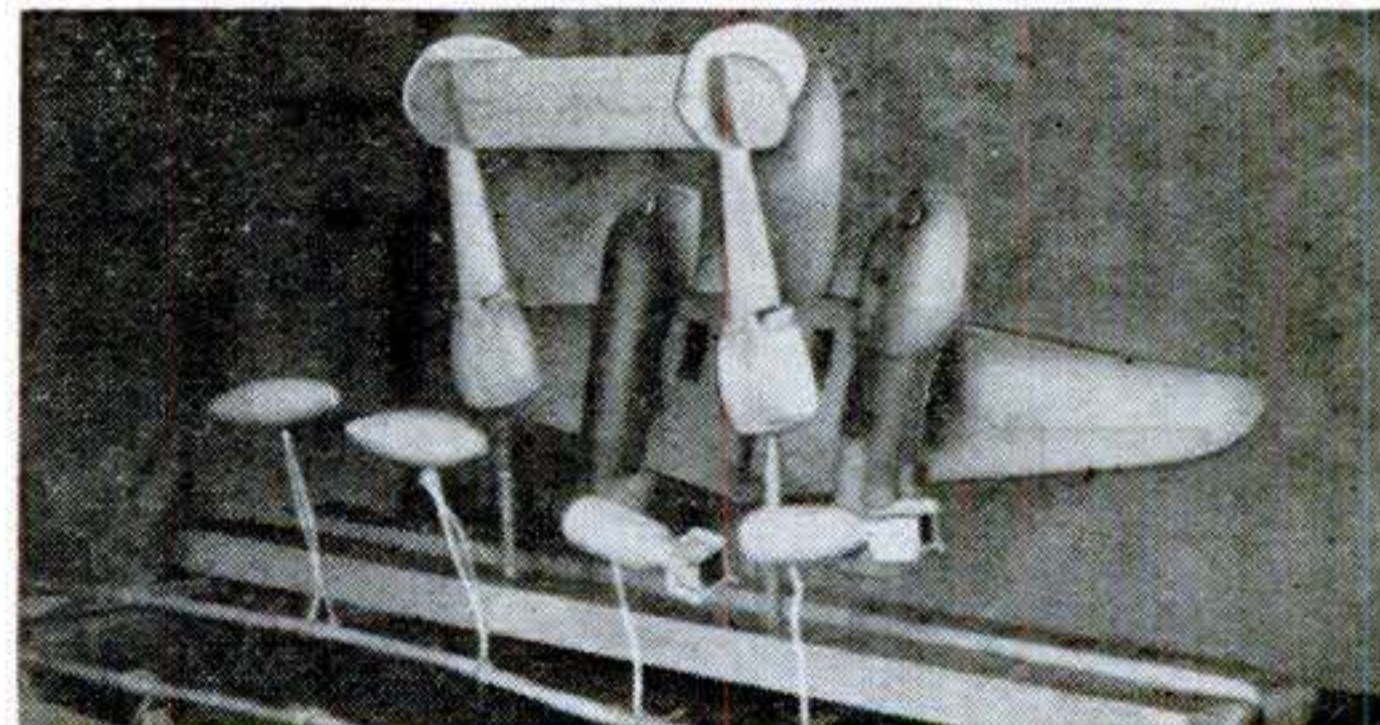

Ready for plating, the cut-apart sections of the model are mounted on stiff copper wire.

quered, filled, relacquered, sanded with No. 400 paper, relacquered, rubbed with pumice and oil, and then cleaned with carbon tetrachloride to remove all traces of oil.

Mix about 2 oz. of copper bronzing powder, 1½ oz. of clear lacquer, and about 13 oz. of lacquer thinner. Mount several brass rods on the work to support it in the tank, perhaps by drilling holes in places that will be inconspicuous in its finished position. Good electrical contact with the surface may be insured by drilling several tiny holes in inconspicuous spots, placing copper wires in them, and touching up these contacts with a brush dipped in the mixture. Spray the work with an even coat. When it has dried, a finger touched to the surface should show some of the copper powder. If none shows, too much lacquer or not enough thinner was used.

Silverplating is generally preceded by copperplating. Electrolyte for the latter is made by dissolving 27 oz. of copper sulphate crystals in sufficient warm water to make a gallon of solution. Then gradually and carefully add 6½ oz. of concentrated sulphuric acid. Increase the quantities proportionately to obtain enough solution to fill your tank. With the tank filled, place two copper or brass rods along the top about 1" away from the sides. Hang from these rods copper strips having an immersed area at least equal to the area of the surface to be plated. These are the anodes, and should be connected to the positive lead from the current source. Connect the nega-

tive lead to a "buffer" (a small piece of clean copper or brass), suspend it from a wooden bar across the the center of the tank, and open the valve that allows air for agitation to enter. Turn on the current and adjust the rheostat until the voltage is between .75 and 2 volts. Then immerse the work, also connected to the negative lead.

If plating is taking place properly, the lacquered surface will take on a pinkish glow. The buffer sheet can be removed as soon as the object is seen to be plating properly. After 15 min., remove the work and inspect it carefully. Color should be a light shade of pink. If it is a darkish pink, the plate is "burning"; the burned areas must be removed and the work recoated with the conductive coating. Reduce the voltage and begin again. If the color is right, continue plating until about 1/32" of metal has been deposited. (Thickness can be measured by caliper comparison.)

If during plating little hydrogen bubbles form on the work, wipe them off and increase the amount of air. Should they form unnoticed and leave pockets in the plating, fill the pockets with soft solder, dress the surface smooth, and replate lightly over the solder.

With copperplating complete, the work is carefully smoothed and polished. This may be done by *very* light filing, buffing with cloth wheels charged with buffing compound, and finally polishing with a clean cloth wheel. Be extremely careful not to go through the thin copper sheath.

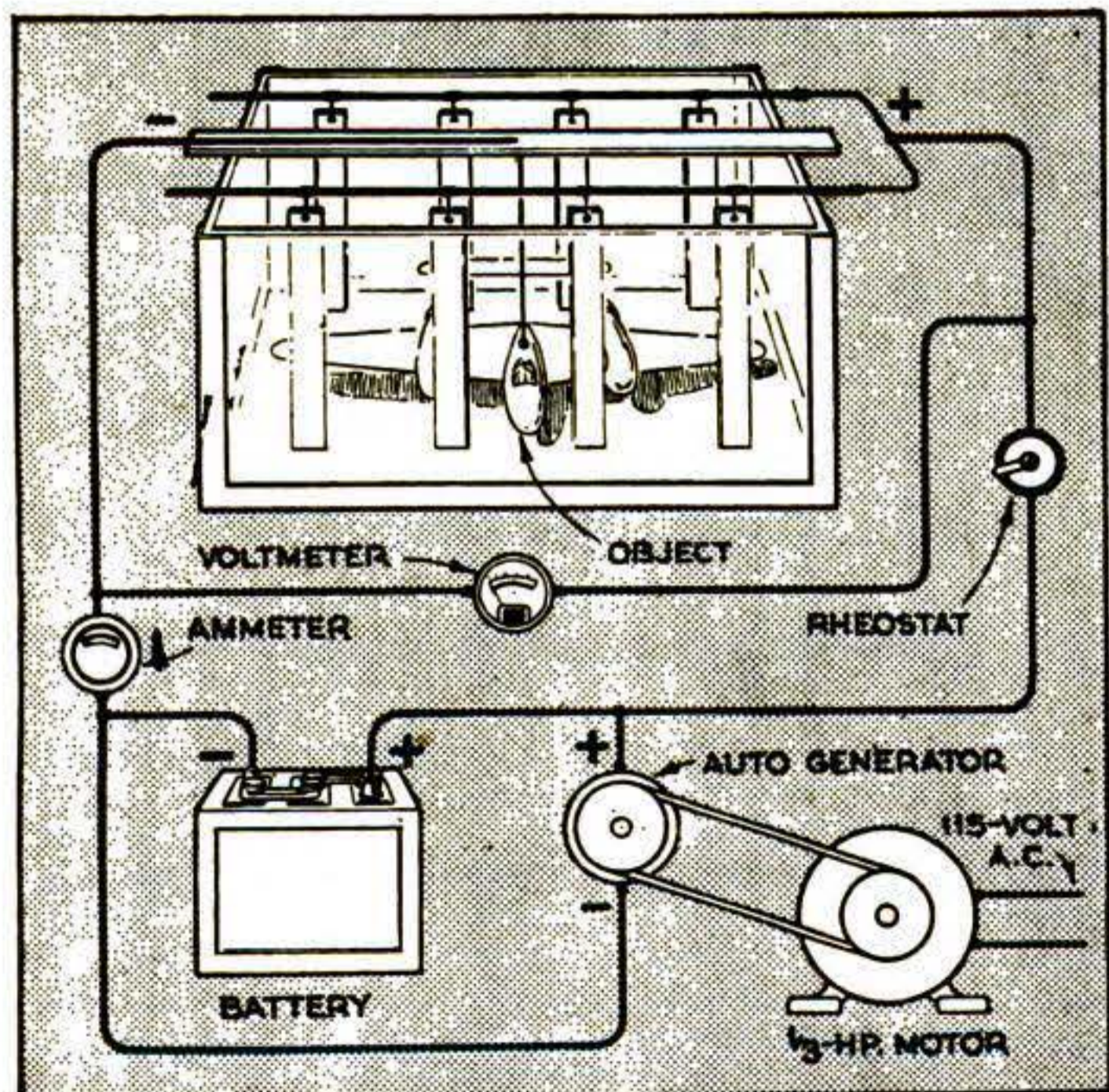

Here's the plating circuit. Disconnect the battery when the generator is not being driven.

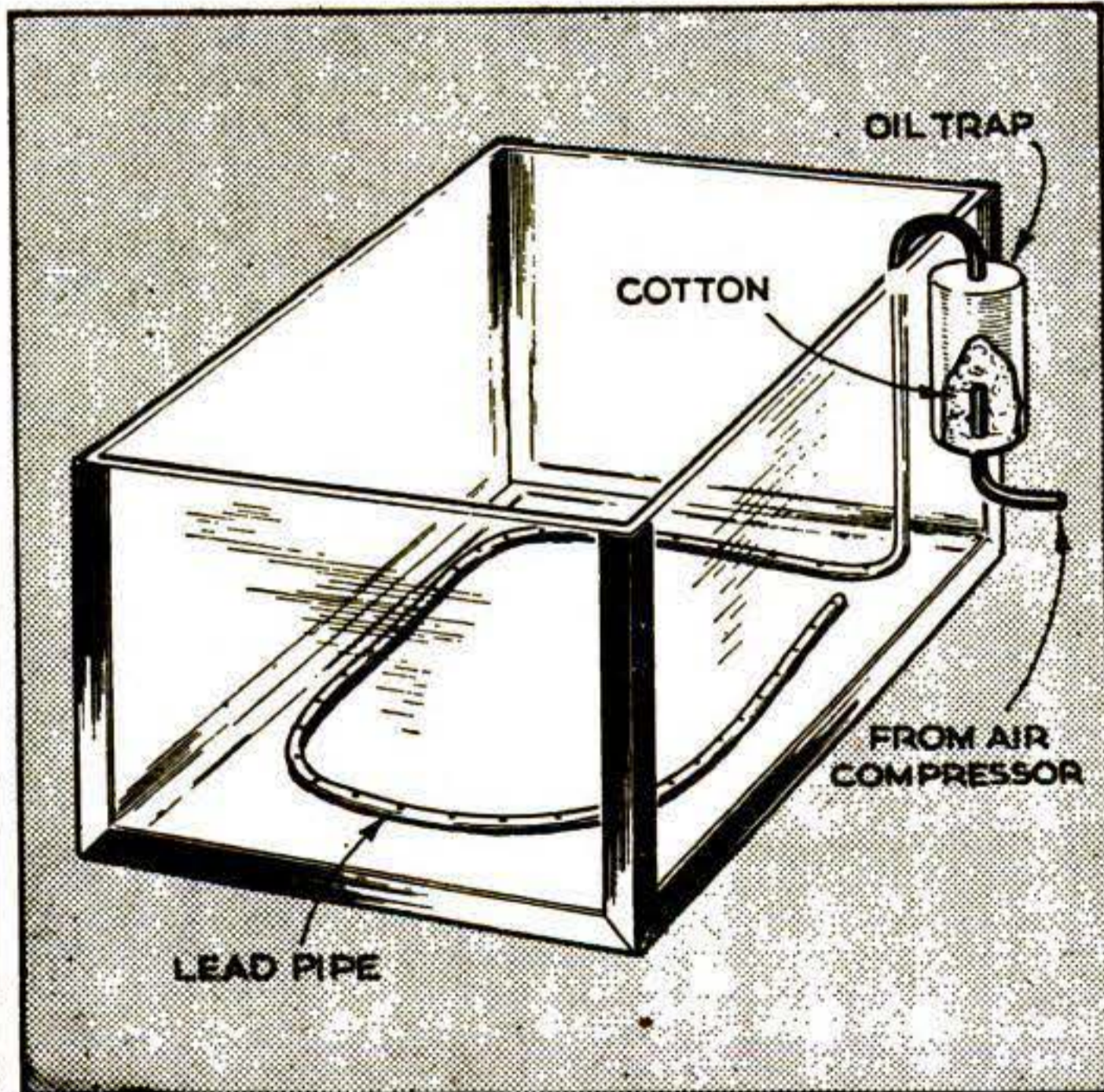

Agitating the electrolyte with air bubbles is important to getting an even plating deposit.

If this happens, it's possible to solder a piece of thin shim brass over the damage, file it smooth, and replating lightly.

Before silverplating, clean the tank with extreme care to remove all traces of the previous solution, or better yet, use another tank. Silverplating is a two-step process; the work is first immersed in a "strike" solution that firmly bonds the silver to the copper, after which the plating is built up in a different solution. The strike solution consists of 8 oz. of sodium cyanide, $\frac{3}{4}$ oz. of silver cyanide, and 4 oz. of sodium carbonate, plus water to make 1 gal. (*Remember that the cyanides are extremely poisonous, and must be handled with great care!*) For anodes during striking, use strips of bright steel having a surface area equal to that of the work. The time of immersion of

the work should be no longer than 1 min. at 6 volts. No agitation is needed. The work should now appear a dirty grey lightly tinged with brown.

For the silverplating itself, use a solution made up of 5 oz. of sodium cyanide, 3.2 oz. of silver cyanide, and 6 oz. of sodium carbonate, plus water to make 1 gal. Anodes should be of pure silver, again with surface area equal to that of the work. It's important to keep the voltage down to from .5 to 1 volt. Inspect the work periodically; it should be white with only a slight tinge of grey. If the color is darker, the voltage is too high and the plate may not adhere. If small nodules of silver form on the work, the voltage is too high or the anodes too close. Agitation with air is not essential but helps greatly in securing an even plate. END

Simple Setup Copperplates Baby's Shoes

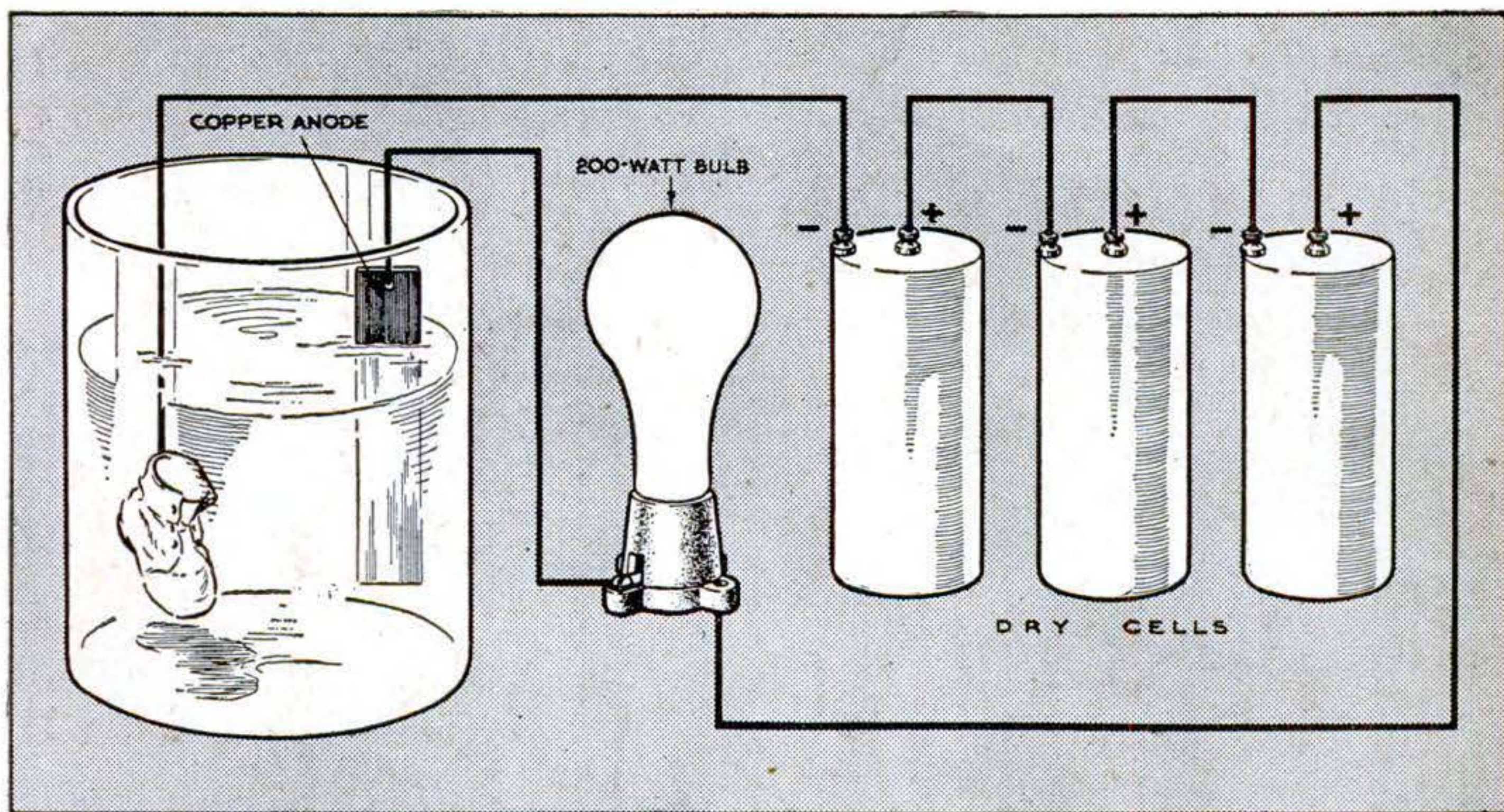

A dry-cell current supply with a lamp to limit current are all that's needed for this rig.

COPPERPLATING a pair of baby shoes will not only please a mother for whom they have sentimental value, but will also afford an easy introduction to electroplating.

Mix plaster of Paris and water to a thick paste and fill the shoe to about $\frac{1}{2}$ " from the top. When it has set, apply two coats of waterproof varnish and allow to dry. Obtain a supply of powdered graphite of the sort used to lubricate locks and rub it thoroughly into the leather until the entire shoe is covered with a shiny coat of graphite.

In a fish bowl or other wide-mouth con-

tainer dissolve 27 oz. of copper sulphate in 1 gal. of water, and then carefully add $6\frac{1}{2}$ oz. of sulphuric acid. Connect three dry cells in series and run one lead through a 200-watt incandescent lamp to limit current flow. Connect the negative wire to some inconspicuous spot on the shoe and the positive lead to a fair-sized sheet of clean copper. During plating turn the shoe frequently, or else suspend it in the center of the jar surrounded by several copper anodes. Wash off the electrolyte, polish the shoe, and coat with clear lacquer.—H. L. KEYTON.

Chemistry Spins a Yarn

By **Kenneth M. Swezey**

TRANSFORMATION of tree fibers or cotton linters into rayon fabrics is one of the greatest achievements of modern industrial chemistry. Chemically, rayon is almost pure cellulose, the same as cotton and linen. But instead of using cellulose as found in nature, the rayon chemist starts with cheap and plentiful spruce and hemlock trees, or the fuzz that clings to cotton seed after it has been ginned. He chops these up, dissolves them, and then causes the cellulose to reappear in silky filaments that may be spun, twisted, knit, or woven into forms that compete successfully with cotton, silk, linen, or wool.

Although the rayon industry is less than

60 years old, and modern rayons less than 15, the idea that man might imitate the silkworm dates back to the 17th Century. In 1664, Robert Hooks, an English scientist, wrote that natural silk is merely a "glutinous excrement" from the body of a worm, and he wondered why men couldn't do as well by squeezing a suitable gum through tiny holes.

Count Hilaire de Chardonnet was the first to accomplish this on a commercial basis. One day while he was coating some photographic plates with collodion, the bottle slipped and broke on the table. When he tried to clean up the mess some time later, the partly dried collodion stretched into long threads. With this as a beginning, Chardonnet worked 30 years to perfect a



How rayon is made by the cuprammonium process may be shown at home. Add a sodium hydroxide solution to one of copper sulphate.

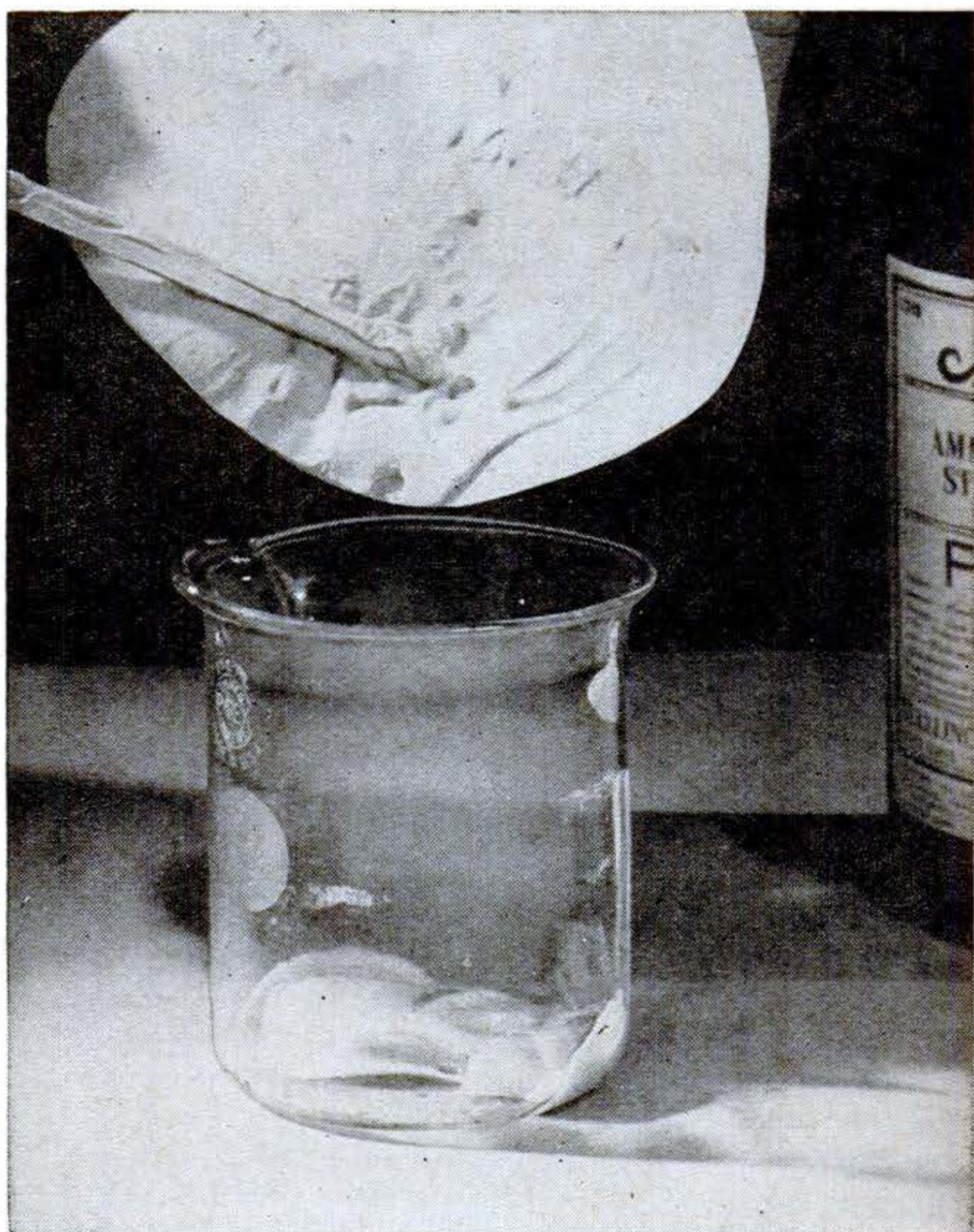

Copper hydroxide precipitates as a pale blue compound. Wash and filter this. Then dissolve in just a little strong ammonium hydroxide.

synthetic yarn. His "Chardonnet silk" was the hit of the Paris Exposition in 1889.

Other methods of taking cellulose apart and putting it together again as textile fibers were soon perfected. Early types were called artificial silk. In 1924, the name "rayon" was adopted for all textiles made artificially from cellulose.

Most rayon is now made by the viscose process. Acetate rayon comes next, while cuprammonium, a superior rayon for certain special uses, is in third place. Although complex machinery and precise technical control are required to produce usable rayon yarn, you can readily demonstrate how cellulose in one form can be broken down and then "regenerated" in a form entirely different. The cuprammonium process has been chosen as the one most easily paralleled at home.

First, make some copper hydroxide by dissolving 5 grams of copper sulphate crystals in 100 ml. water and adding slowly a 10 percent solution of sodium hydroxide

until the pale blue precipitate stops forming. Wash this precipitate by decantation—mixing with water in a tall glass, allowing to settle, pouring off the clear upper liquid, mixing with more water, and repeating the process five or six times.

Filter the precipitate and dissolve the gelatinous solid in the smallest possible amount of 28 percent ammonium hydroxide. With the ammonium hydroxide, the copper hydroxide forms a complex deep-blue compound. The resulting solution (called Schweitzer's reagent from the German chemist who discovered it) dissolves paper, cotton, wood, and other forms of cellulose.

Commercially, cuprammonium rayon is made from cotton linters. If you wish, you may use absorbent cotton, but filter paper—a pure form of cellulose—will dissolve much faster. Tear up a 15 cm. sheet and put it into the blue solution. Stir occasionally until it has completely dissolved. This may take several hours.

In commercial practice, the solution is

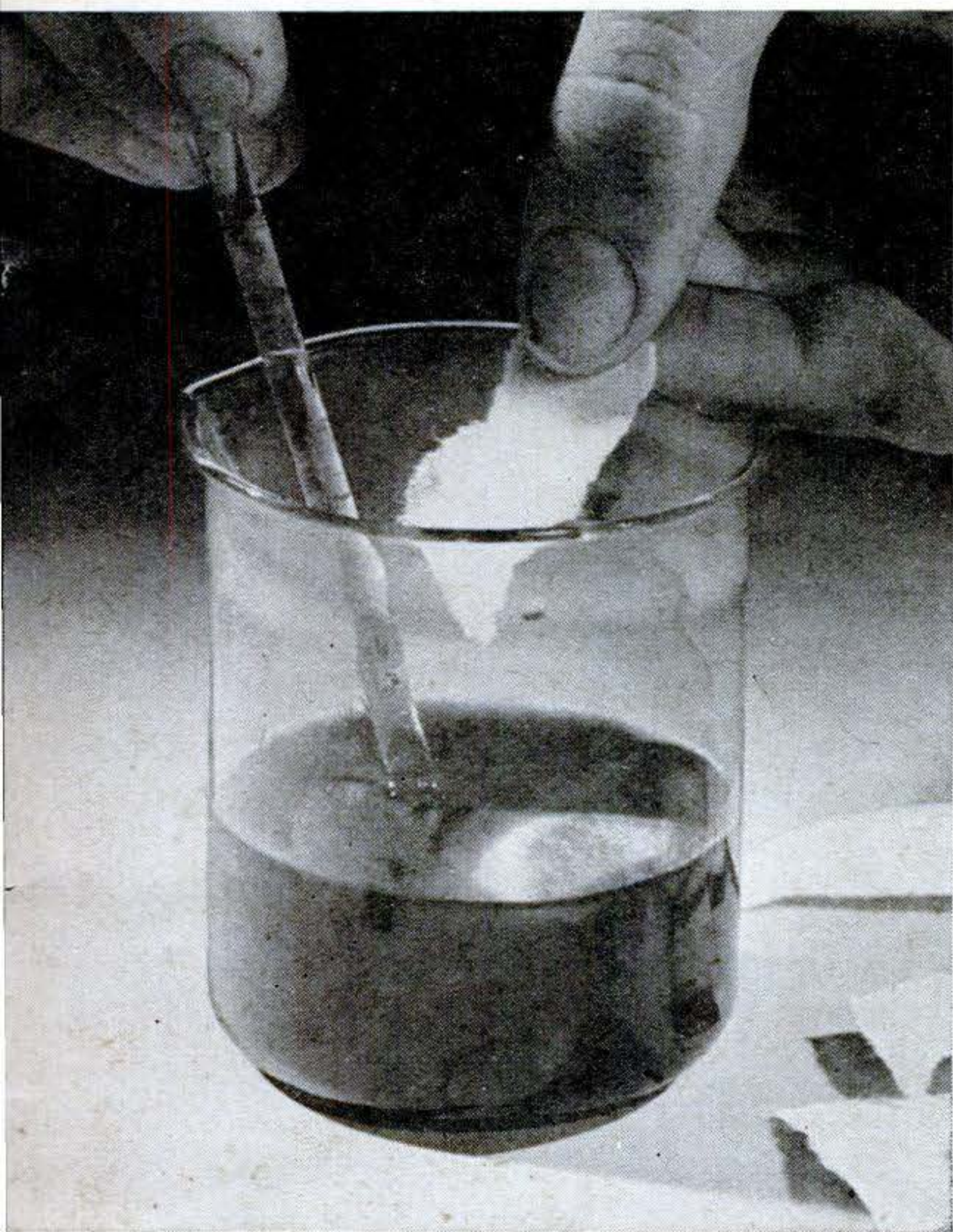

Called Schweitzer's reagent, this deep-blue solution dissolves cellulose. Dissolve enough filter paper to produce a syrupy solution.

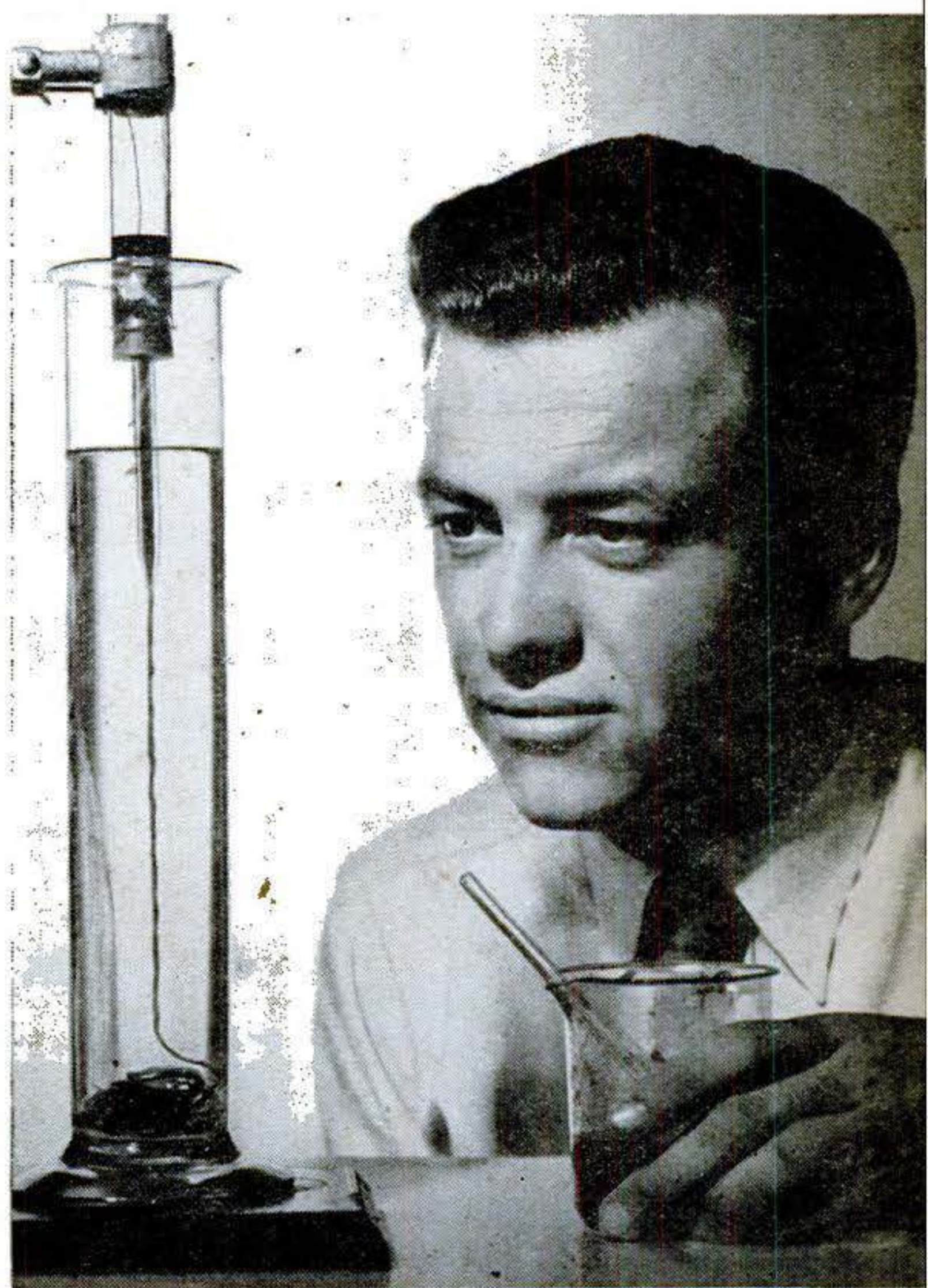

Rayon thread forms when dissolved cellulose flows down through a small opening from the upper tank into a dilute sulphuric acid bath.

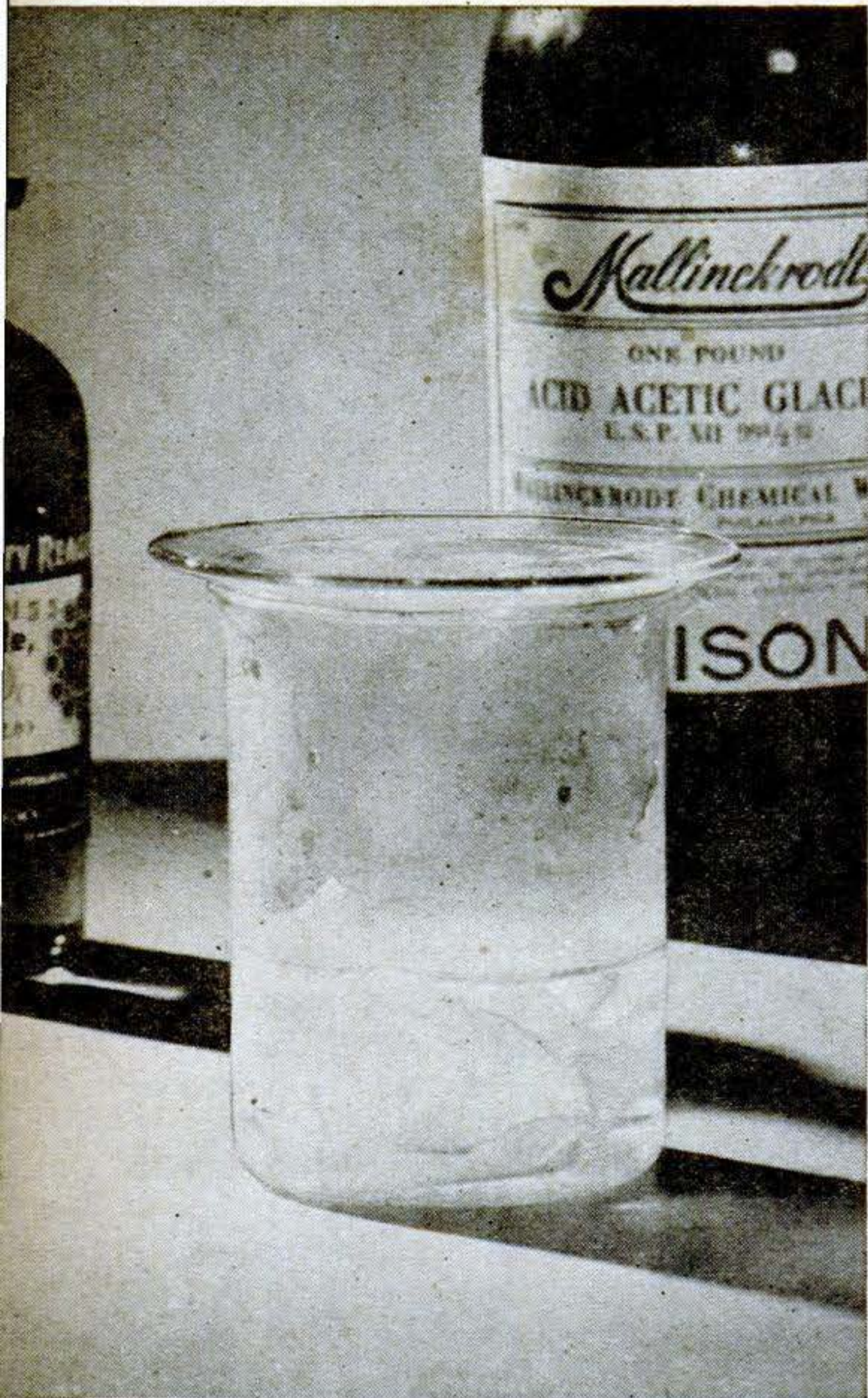

Acetate rayon also may be made at home. Mix acetic acid, acetic anhydride, and a few drops of sulphuric acid. Dissolve some filter paper.

now filtered and air bubbles removed. Then it is pumped to the spinnerets—disks with tiny holes through which the solution is forced. The spinnerets are located at the upper end of a cylinder through which water is flowing downward. This water starts to coagulate the threads and stretches them. The filaments are completely coagulated in dilute sulphuric acid.

In your home setup, the spinneret can be a glass tube drawn to a 1-mm. opening at one end and fitted into a stopper that is inserted, in turn, into the lower end of a tube about 1" in diameter and 6" long. The large tube serves as a tank from which the solution can be gravity-fed to the coagulating bath, a 5 percent solution of sulphuric acid in a large cylinder.

Before lowering the outlet tube beneath the surface of the coagulating bath, half fill the tank with the cellulose solution. Be

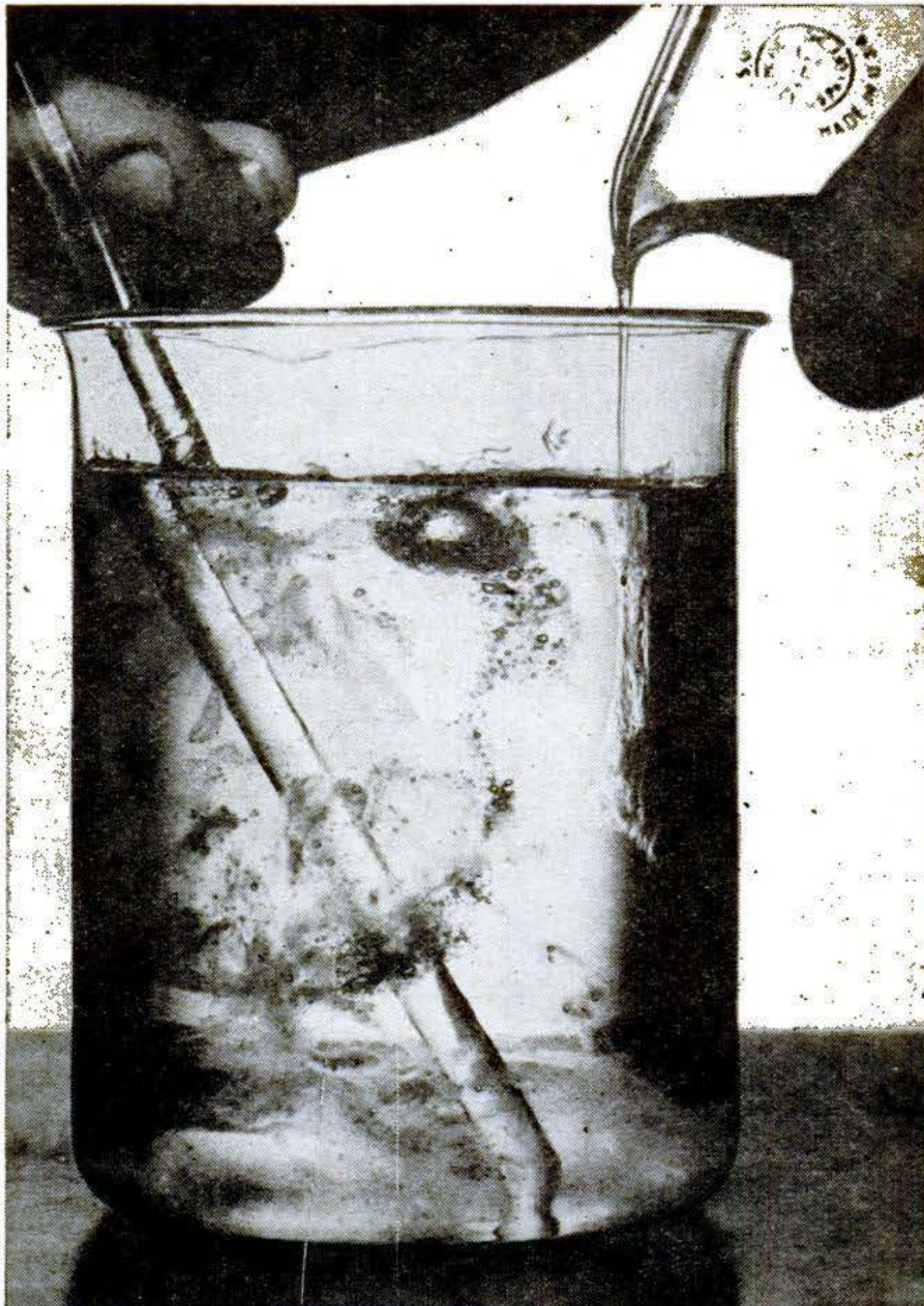

Pour the solution slowly into a large beaker of water. This will precipitate the cellulose acetate. Remove from the water by filtering.

sure the solution is free from undissolved cellulose as this would clog the opening. As a further precaution, run a fine copper wire down through the opening. By manipulating the wire, you can clear the opening if it becomes clogged.

To complete the experiment, lower the filled spinneret until the delivery tube is several inches below the surface of the bath. If the solution doesn't flow, give it a few prods with the wire. At first, the issuing thread may tend to rise, but gradually it will sink. Commercial cuprammonium filaments are much finer, of course, and are stretched during the spinning to give them greater strength. The final treatment consists of washing, drying, and twisting into yarn or thread.

Viscose rayon usually is made from cellulose derived from wood pulp. After being steeped in sodium hydroxide solution, this



Dry the compound thoroughly by blowing warm air over it. Then dissolve the dry compound in the smallest possible volume of acetone.

pulp is squeezed almost dry and allowed to age for several days. Treated with carbon disulphide, the alkali cellulose changes to cellulose xanthate. Dissolved in sodium hydroxide solution, this forms a viscous amber-colored solution that is forced through spinnerets in much the same way as cuprammonium solution.

Unlike cuprammonium or viscose rayon, acetate rayon is not merely cellulose that has been taken apart and put together again. Instead, it is a real compound of cellulose—cellulose acetate, the material of which most photographic film is made. All you must do to make filaments of this substance is to dissolve it in acetone, or other suitable solvent, squirt it through little holes, and finally pass it through warm air. The heated air rapidly evaporates the solvent, leaving a solid thread.

You can make cellulose acetate by dis-

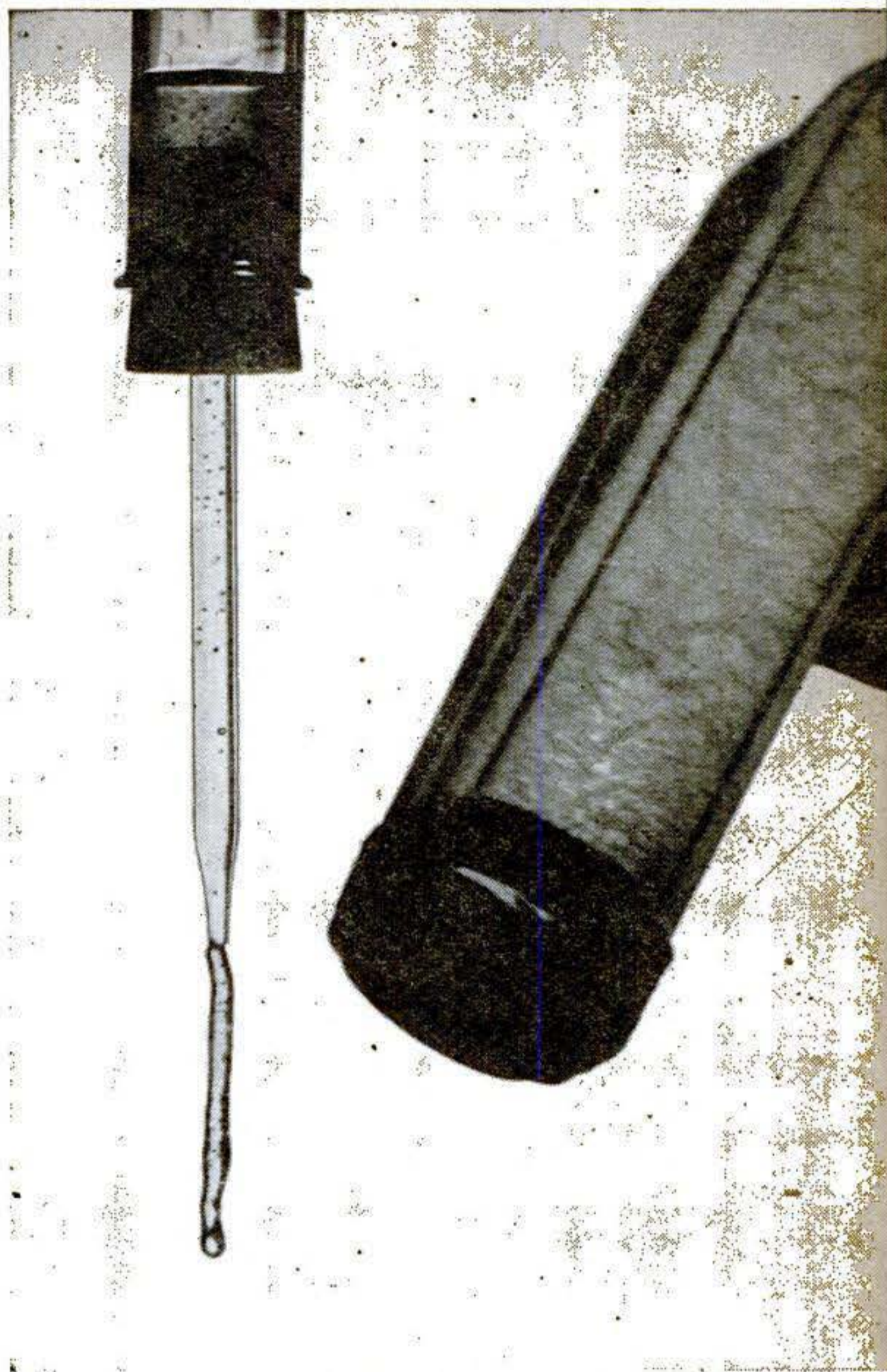

Acetate thread is "spun" when the dissolved cellulose acetate oozes from the tank at the top. Warm air quickly evaporates the solvent.

solving 1 gram of filter paper in a mixture of 40 ml. of glacial acetic acid and 12 ml. of acetic anhydride, with 6 drops of concentrated sulphuric acid added as a catalyst. Complete solution will take at least eight hours. Stir it occasionally.

When the paper has been fully dissolved, you can recover the cellulose acetate by pouring the solution in a thin stream into a large volume of water, stirring constantly. Then separate the compound by filtering it, press out the excess water by squeezing the compound between filter papers, and dry—either in the open air or by directing upon it the warm blast from an electric drier.

When dry, dissolve in the smallest possible amount of acetone. Place the resulting solution in the "tank" used in the previous experiment. This time the solution just flows into the air where heat from the drier solidifies it.

END

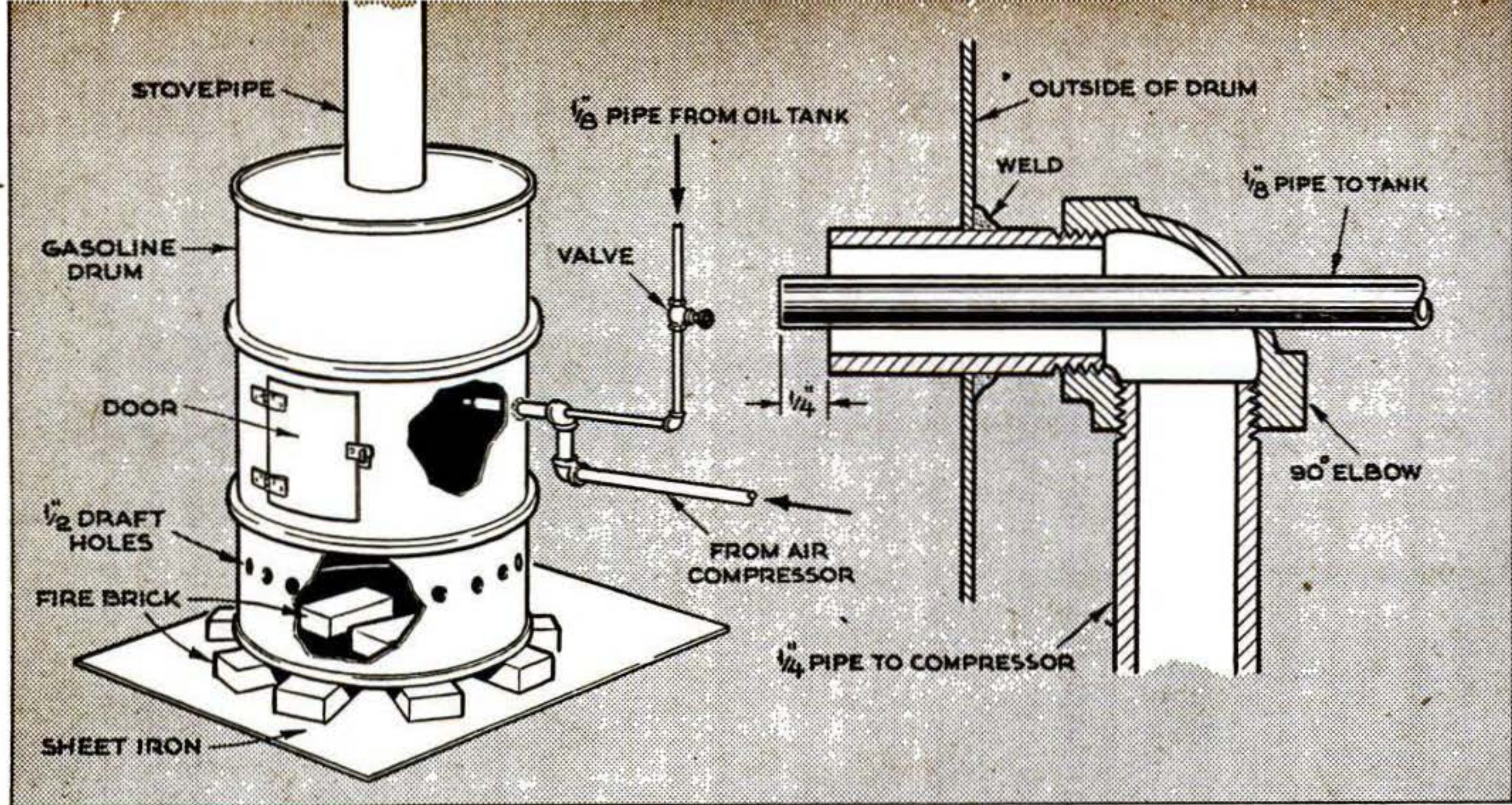

Homemade Shop Stove Burns Crankcase Drainings

THIS efficient oil stove, which uses old crankcase drainings as fuel, has for several winters provided cheap heating of a good-sized repair shop. Compressed air from the shop air line "atomizes" the fuel and gives a steady, hot flame.

A 55-gal. drum, fitted with a door and a stovepipe chimney, serves as the body of the stove. The bottom is covered inside with firebrick, and a ring of bricks elevates the drum from the floor. The air nozzle consists of a short length of $\frac{1}{4}$ " pipe welded

to the drum. Inside it and protruding $\frac{1}{4}$ " farther is the $\frac{1}{8}$ " fuel-supply pipe. Valves in both lines permit adjusting the stove for best combustion and the desired amount of heat. The oil reservoir, located some distance away for safety, feeds the stove by gravity. To start it, the stove is warmed by burning newspapers inside, and then the oil and air lines are slowly opened. If possible, use a long run of stovepipe to get the maximum radiation, fitting it if necessary with a device to check down drafts.—C. F. STRAHM.

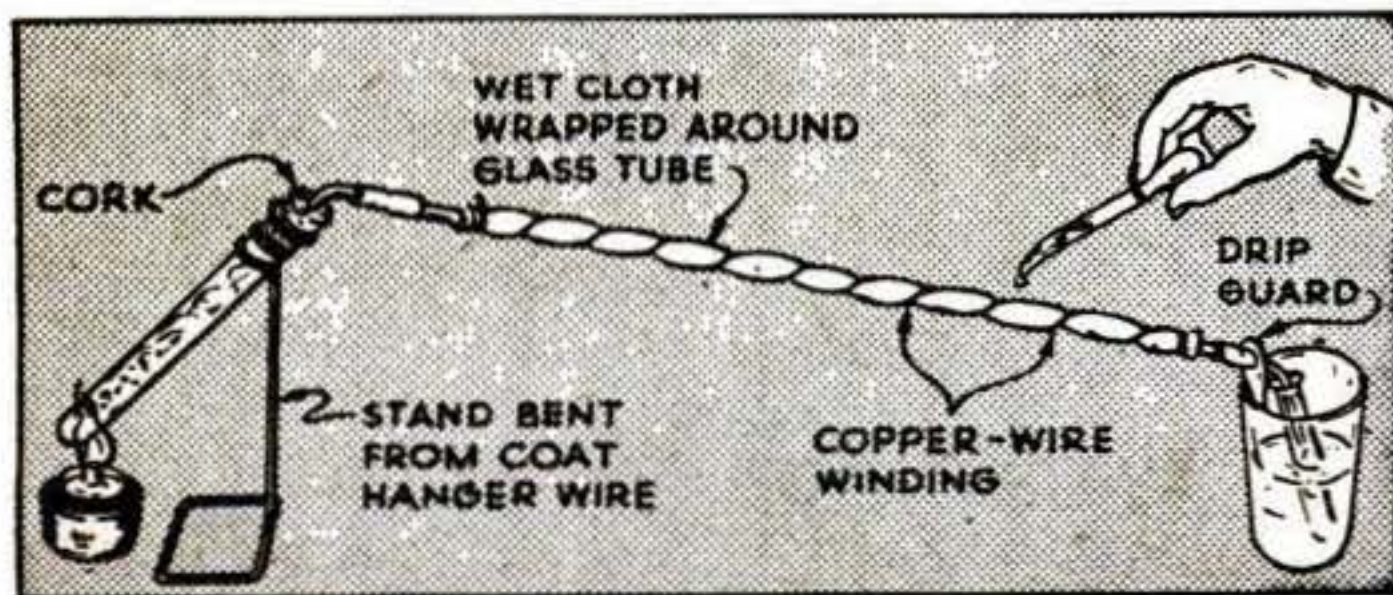

Lab Still Uses Odds and Ends

IN A few minutes you can put together the little distilling setup shown above, which is entirely satisfactory for many home-lab purposes. The wet cloth wrapped around the long tube will provide almost as much cooling as tap water circulating in a water jacket. Be sure to use a guard to keep the drip from the condensate. Don't apply heat too fast or unevaporated solution may bubble into the line. A few short pieces of glass tubing in the first test tube will keep big bubbles from forming. You'll find that an ordinary medicine dropper will provide a handy and controllable way of supplying water to the cloth.—JOHN L. STORY.

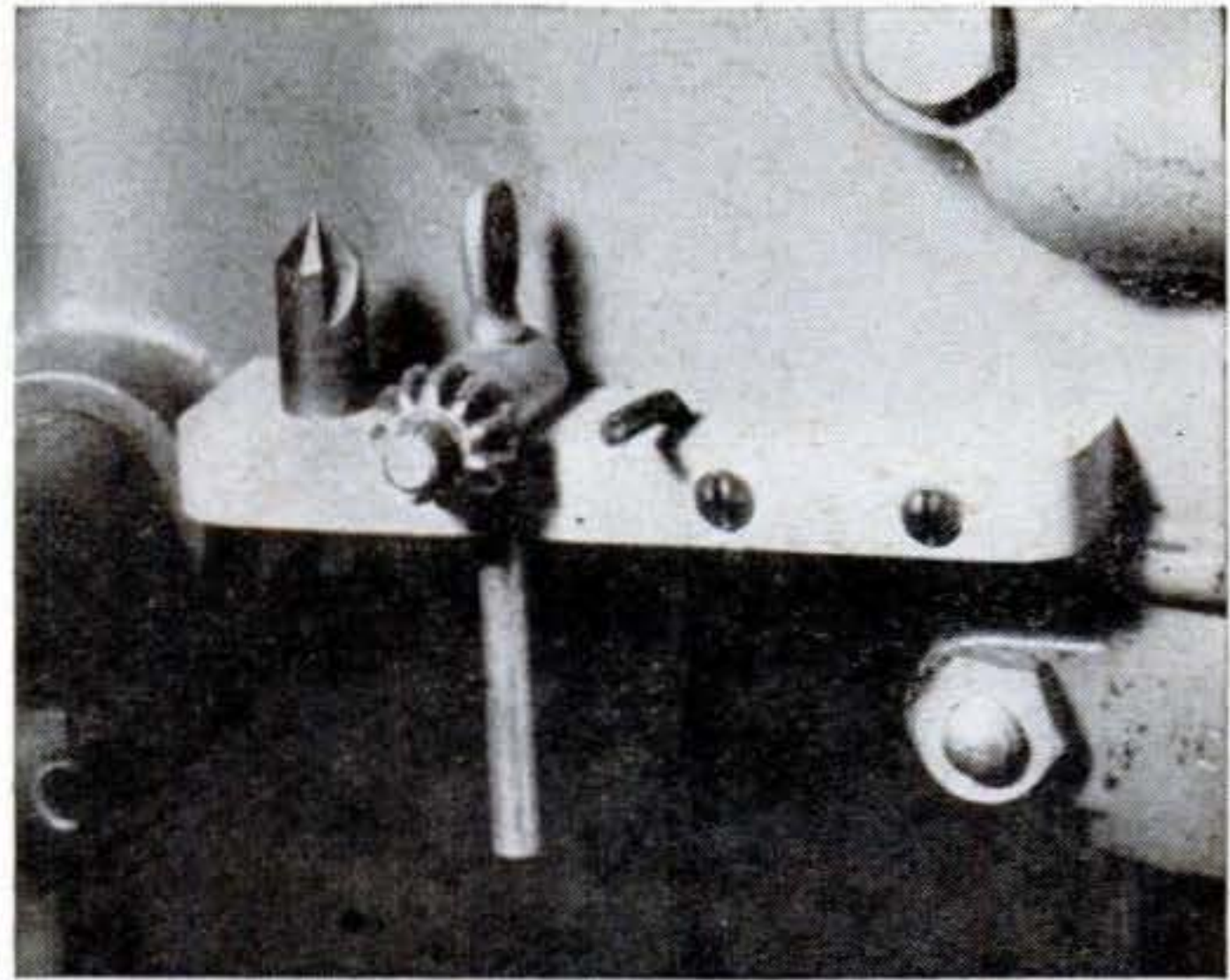

Drill-Press Rack Holds Tools

BOLTED to the drill-press head by two machine screws in tapped holes, this hardwood rack holds the chuck key, Allen wrench, and countersink where they can be easily found. A half-round groove is filed across the top of the rack over the chuck-key hole, into which the body of the key fits for orientation.—GLENN A. WAGNER.

Portable Platform Hooks On Window Casing

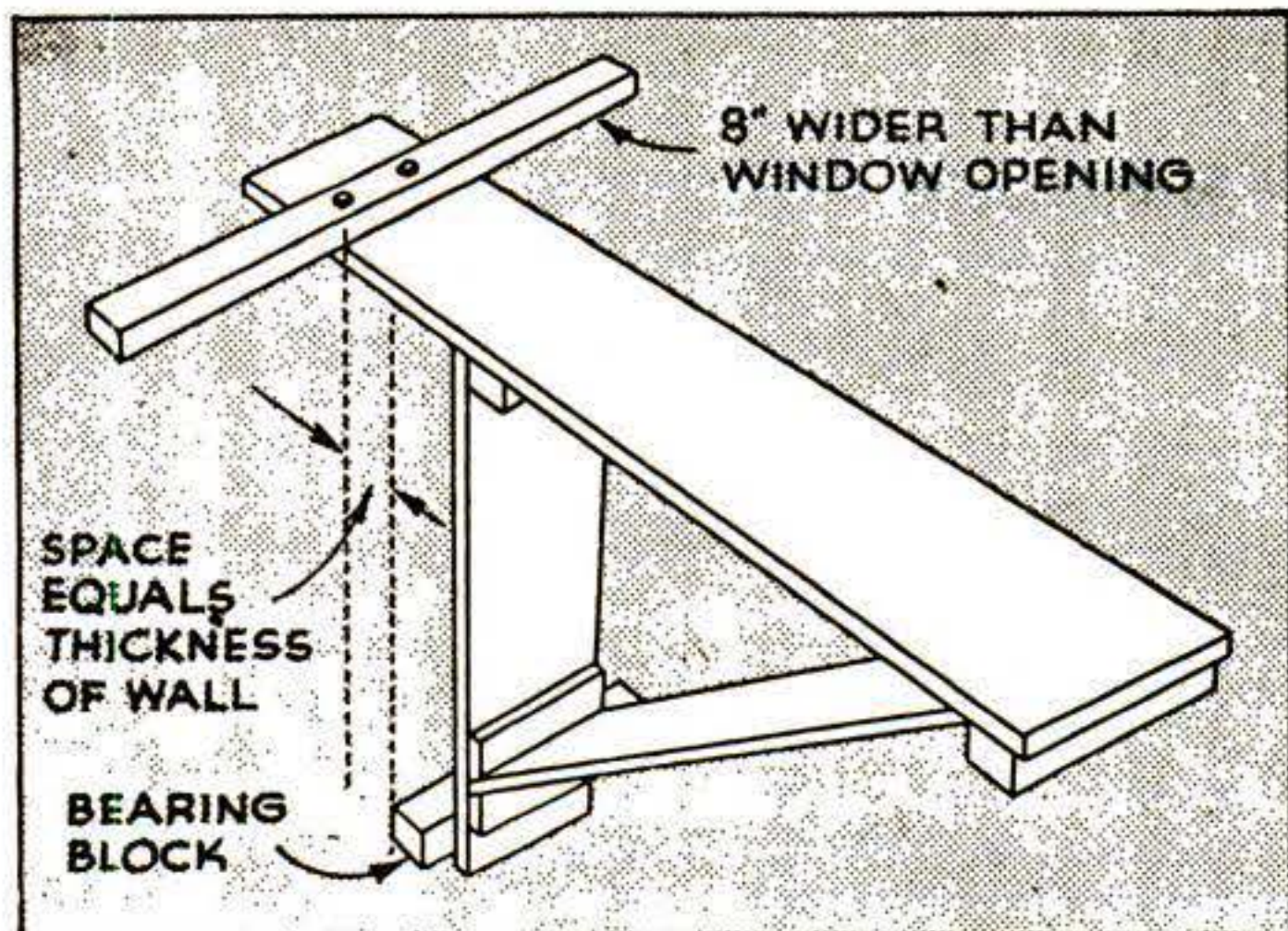

PAINTING upstairs windows usually involves manhandling an extension ladder into place and then teetering alongside the window during work. This homemade platform, set in place from inside the room, can be moved easily from window to window,

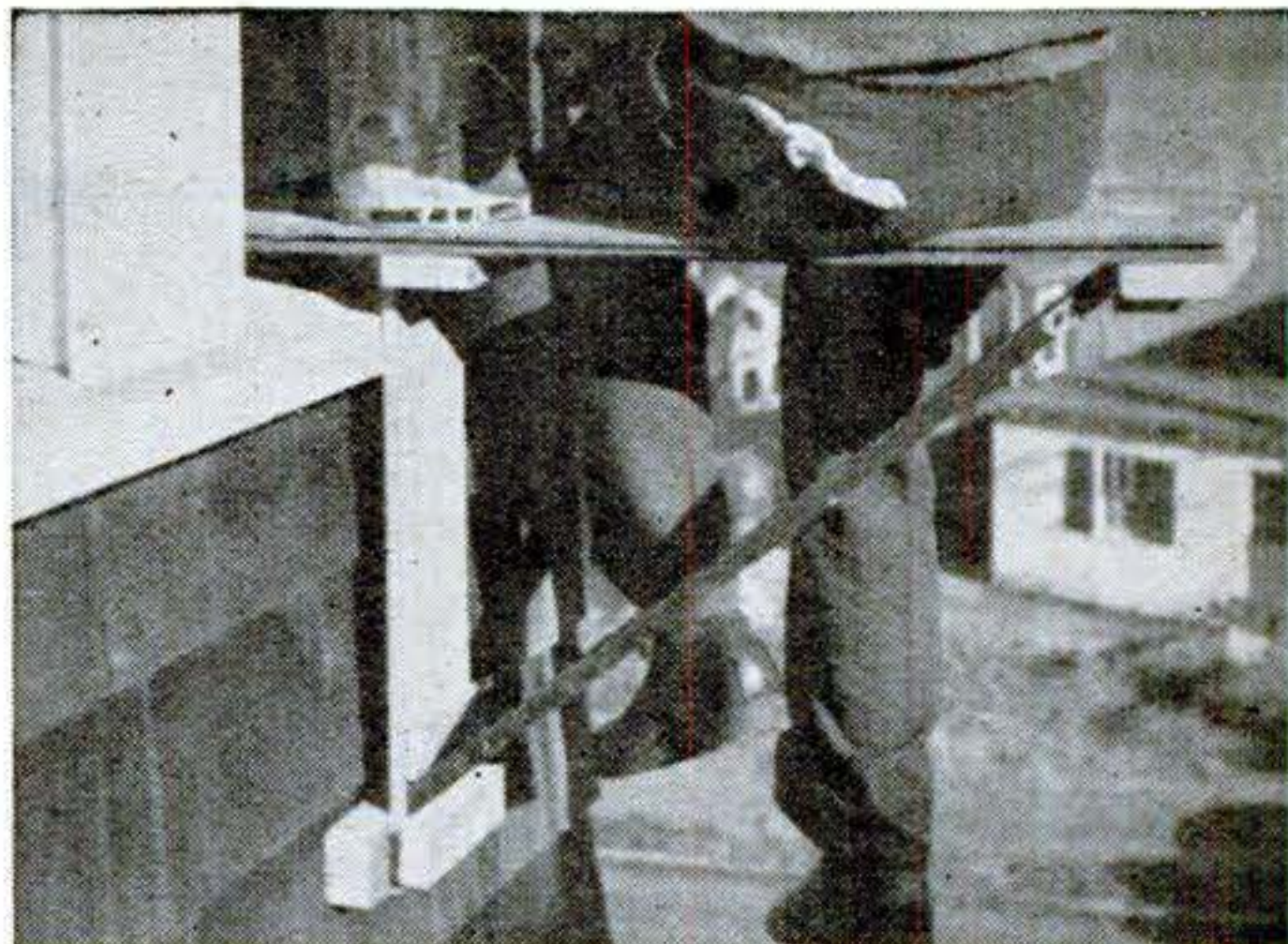

and affords a steady and convenient working surface. Use sound hardwood for its construction, and pad the crosspiece to prevent marring the finish inside. Carriage-bolt assembly will allow compact storage when the unit is not in use.—J. RODGER DARLING.

Folded Paper Locates Centers

TO FIND the center of a piece of round stock, make a tracing of the work on thin paper. Holding the paper up to the light, fold it twice as shown. Then unfold the paper, place it carefully on the work, and prick-punch the intersection of the fold lines.

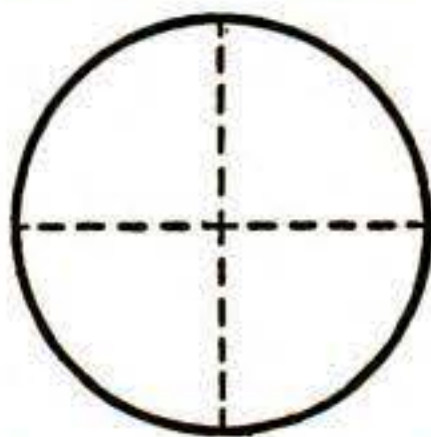

T-Square Marks Guide Borders

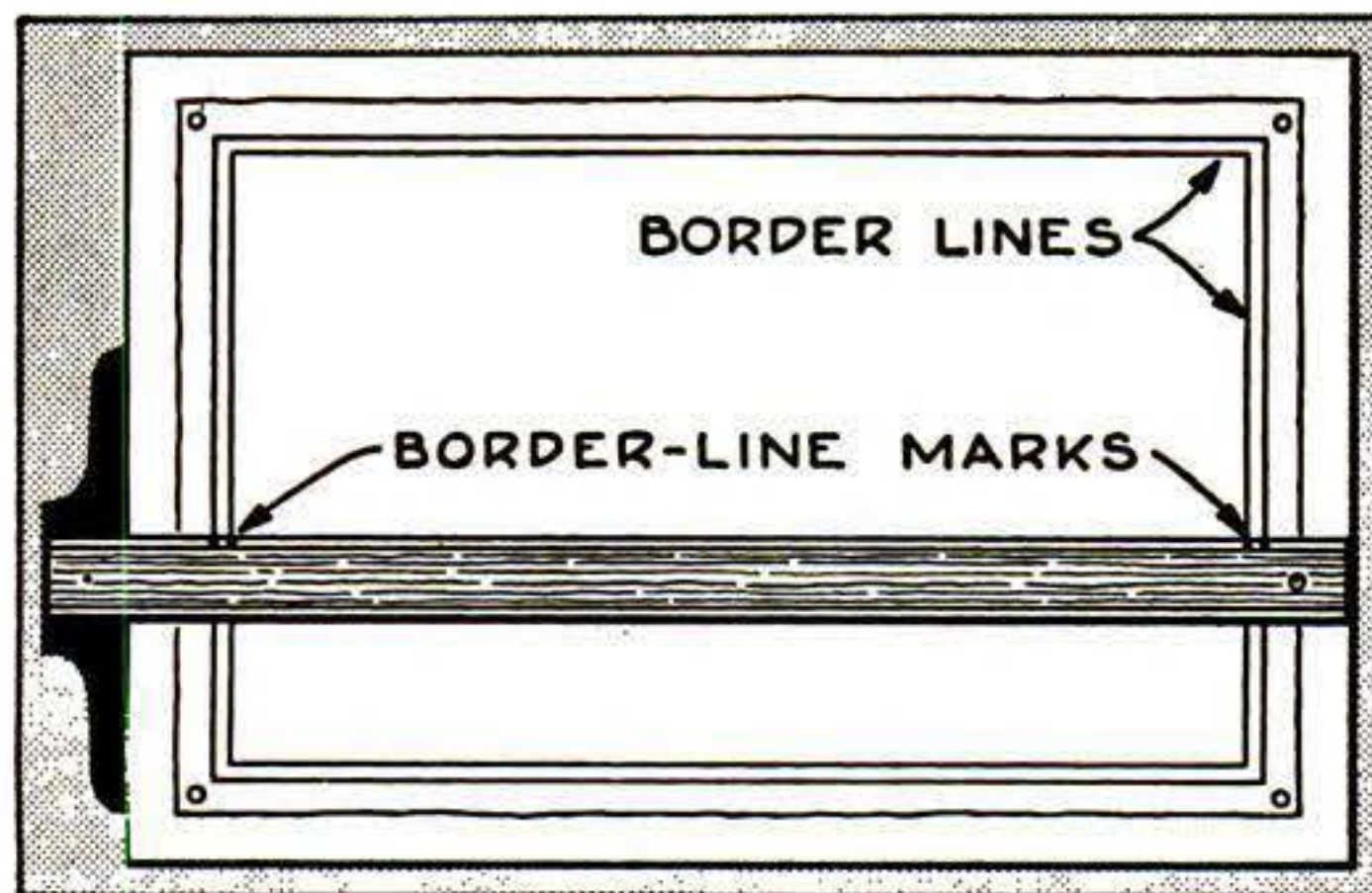

DESIGNERS and draftsmen frequently have occasion to lay out many drawings having the same border dimensions. To save time, scribe and ink in the width and height dimensions on the plastic edges of the T-square. Points are then made adjoining these marks at each edge of the drawing, and the T-square is inverted for use as a straightedge while the connecting lines are drawn.—JOHN G. KINGDON.

Baby Enjoys Carriage Window

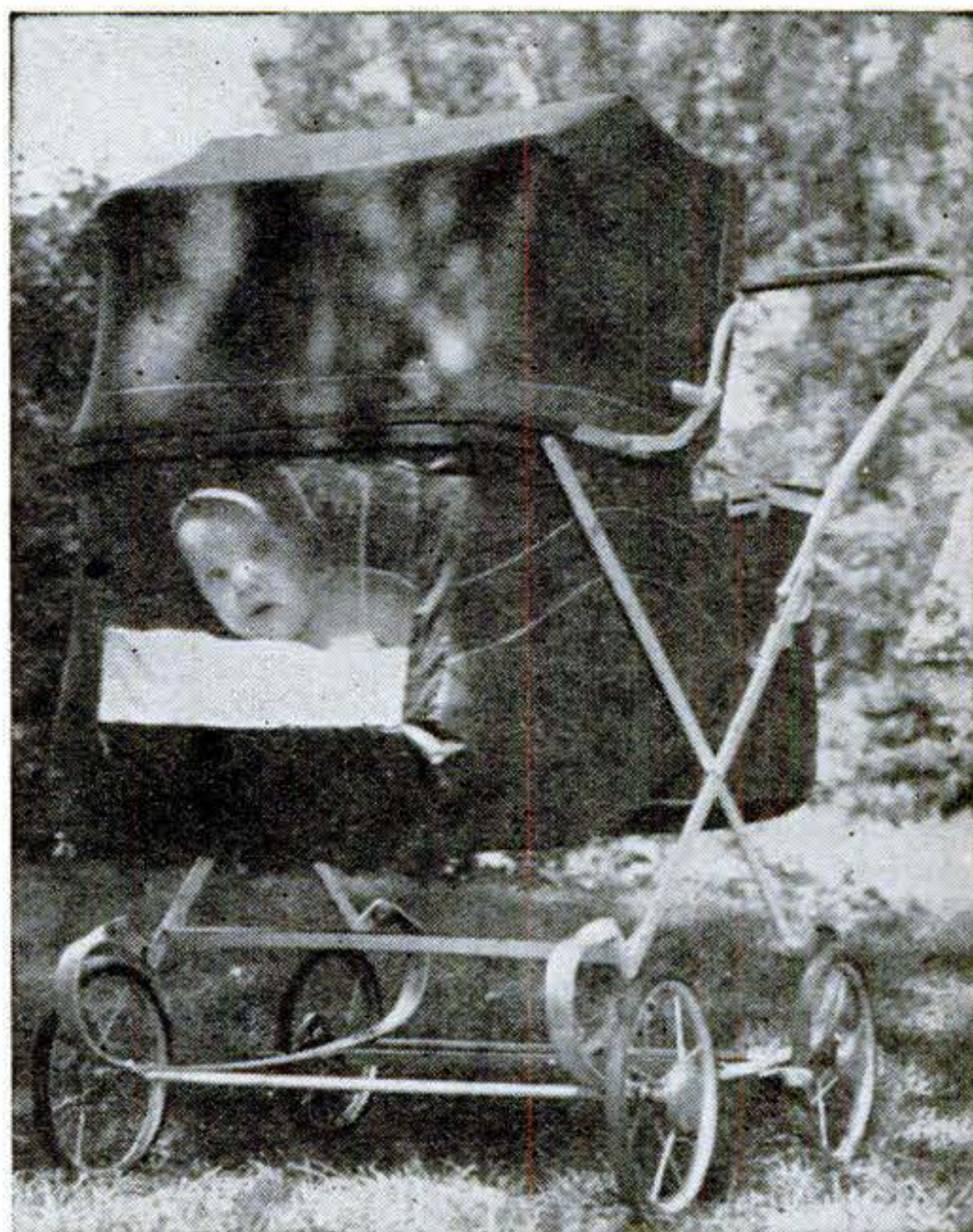

MOST very small fry like to lie on their stomachs, and in a carriage they also try to peer over the top. Often the result is that, on bumps, small heads are jounced against the carriage rim. I stitched a sheet of clear acetate in the front of the carriage, and now our youngster props himself solidly on his elbows and gazes out happily through his own private windshield while being rolled along.—LYELL D. HENRY, JR.



HOME EXPERIMENTS

How Heat and Electricity Affect Each Other

THAT all energy is somehow related is very evident in the behavior of heat and electricity. The toaster and electric iron convert kilowatts into useful heat. But a thermocouple—simply two pieces of dissimilar metals welded or soldered together—changes heat directly into electricity when one joint is put into a flame.

Heat affects electrical conductors too. When you turn on a 100-watt bulb, its cold filament has about a tenth of its hot resistance, and there is a tremendous surge of current—about 9 amp. for a millisecond or two. But the filament immediately gets hot. In a tenth of a second its resistance rises until it draws only its rated .8 amp.

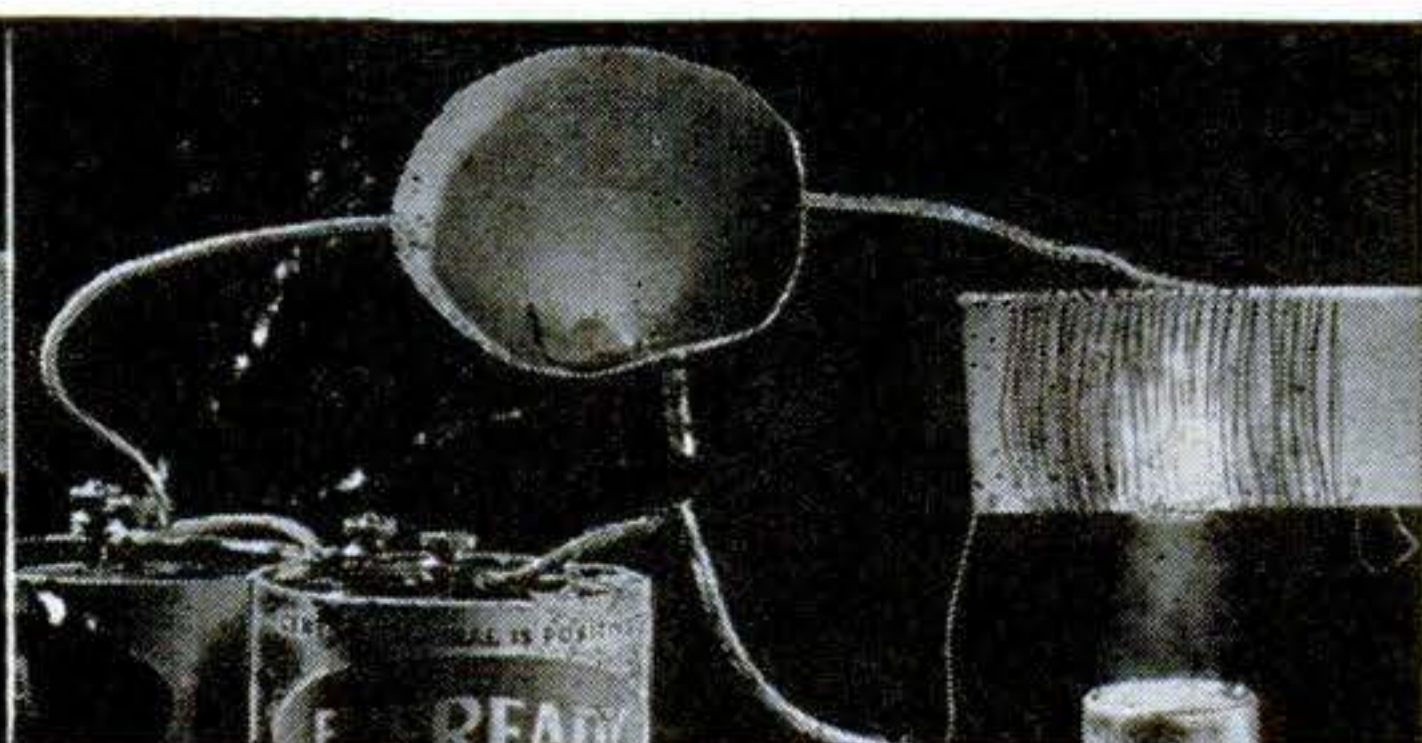
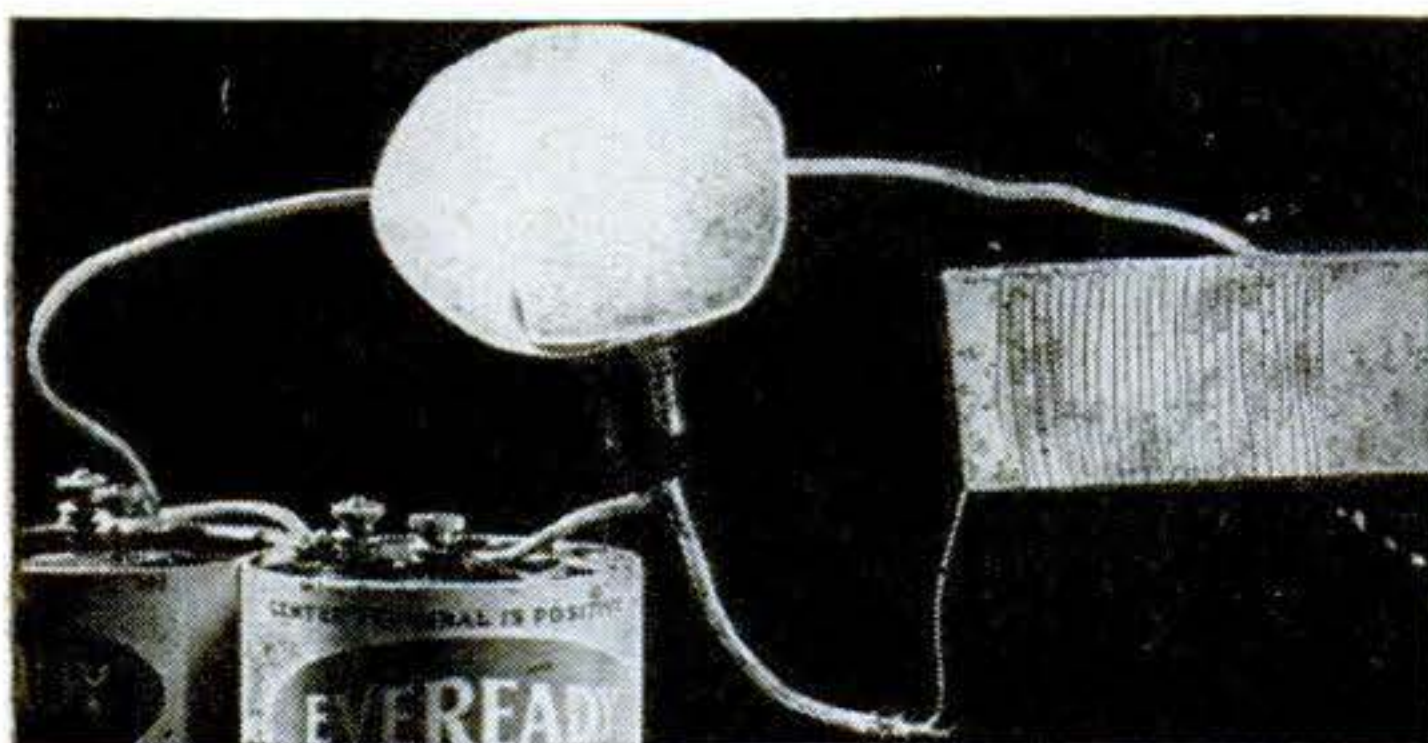

Heat Increases Resistance. You can safely use more lights on a single circuit without blowing a fuse if you turn them on one at a time. The reason? Almost all metals, including lamp filaments and heating elements, have greater resistance when they are hot than while cold. Hence, they pass less current after heating up.

You can demonstrate this characteristic

of metallic conductors by connecting a 3-volt flashlight bulb in series with two dry cells and about 10' of thin iron wire wound around a strip of asbestos. While cold, the wire has a low resistance and enough current passes to cause the bulb to shine brightly. But put a flame under the wire, and the resistance becomes so great that the light will dim—and may go out.



Heat Decreases Resistance. In the case of conducting solutions, or electrolytes, the resistance decreases as they are heated—as you can demonstrate by another pair of tests. Connect your bulb and dry cells in series with two metal plates suspended in a water-filled beaker. Stir salt in-

to the water until the bulb lights dimly. Now put a flame under the solution. As the solution becomes hotter, the light will grow brighter. Because of this lowering of resistance, electrolytic rheostats must be designed large enough to carry the current that is required without overheating.

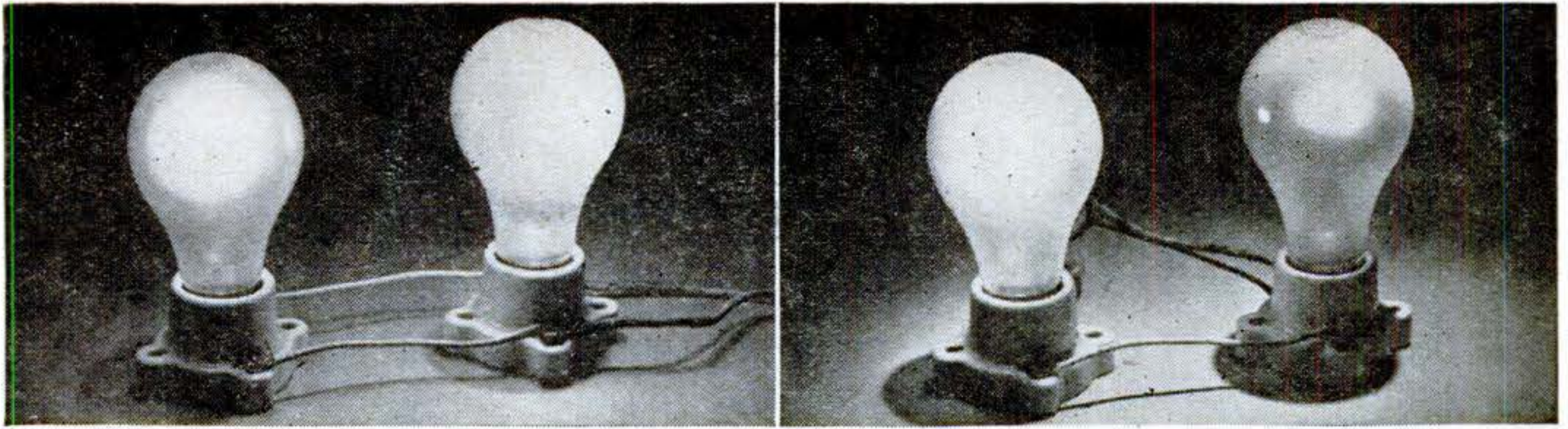

Parallel Versus Series. Heat depends on the current and resistance in a circuit. Thus, if two or more appliances of similar type, such as light bulbs or heaters, are connected in parallel, the bulb or heater with the lowest resistance—which draws the greatest current—gives the most light or heat. As an illustration, the 60-

watt bulb on the right in the left photo has less resistance and so gives more light than a companion 40-watt bulb. But connect the same two bulbs in series, as at the right, and the reverse holds true. The same amount of current now passes through both, but it creates more light and heat in the bulb where it overcomes the higher resistance.

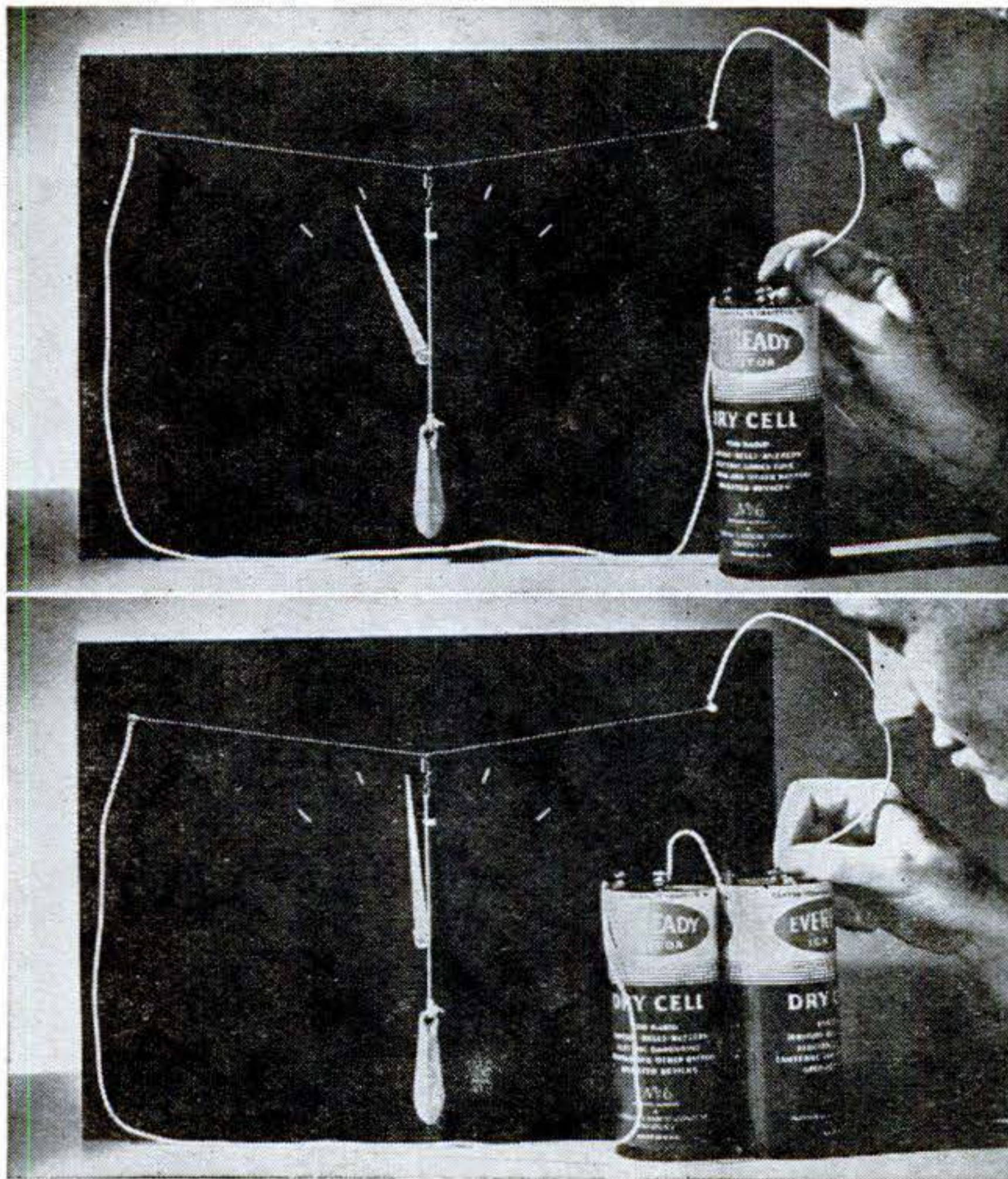

Heat Actuates Meters. Because the heat produced in a wire or circuit is proportional to the square of the current flowing through it, and because heated metals expand in a predictable way, the heating effect of electricity is used in one type of instrument to measure amperage or voltage.

You can easily demonstrate the principle of a "hot-wire" meter. Stretch a strand of iron picture wire horizontally between two nails driven into a board. At the center,

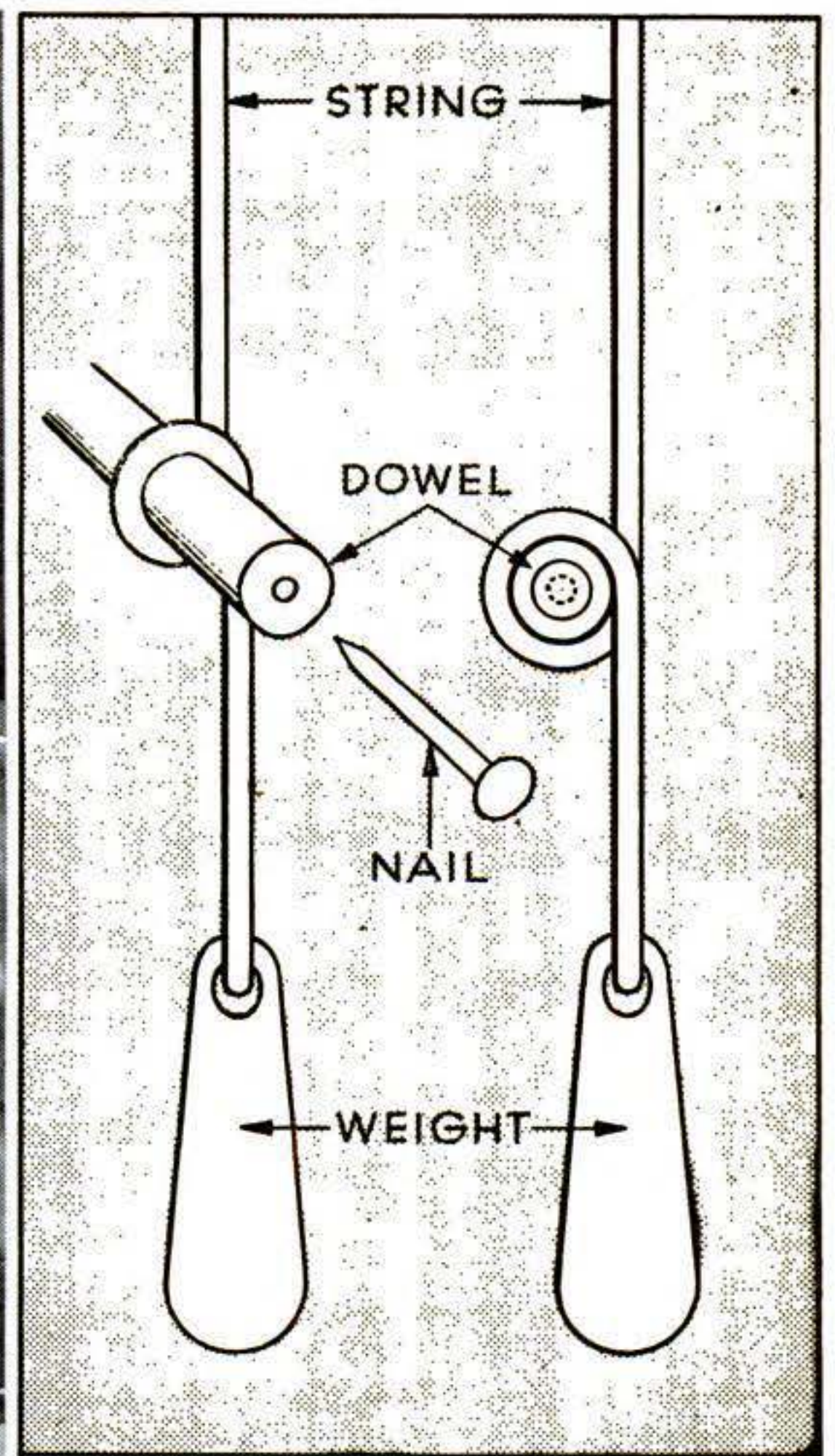

suspend a wire hook connected to a string held taut by a weight. Drill a hole through the center of a short dowel, cement a cardboard pointer to the dowel, and mount the dowel to turn freely. Loop the string once around the dowel so that the pointer moves to the right when the weight is pulled down.

Connect a single dry cell to the supporting nails, and the pointer will move slightly as the wire heats, expands, and sags. Connect two, and the movement will increase.

Two Aids Speed Service on Pump Located in Pit

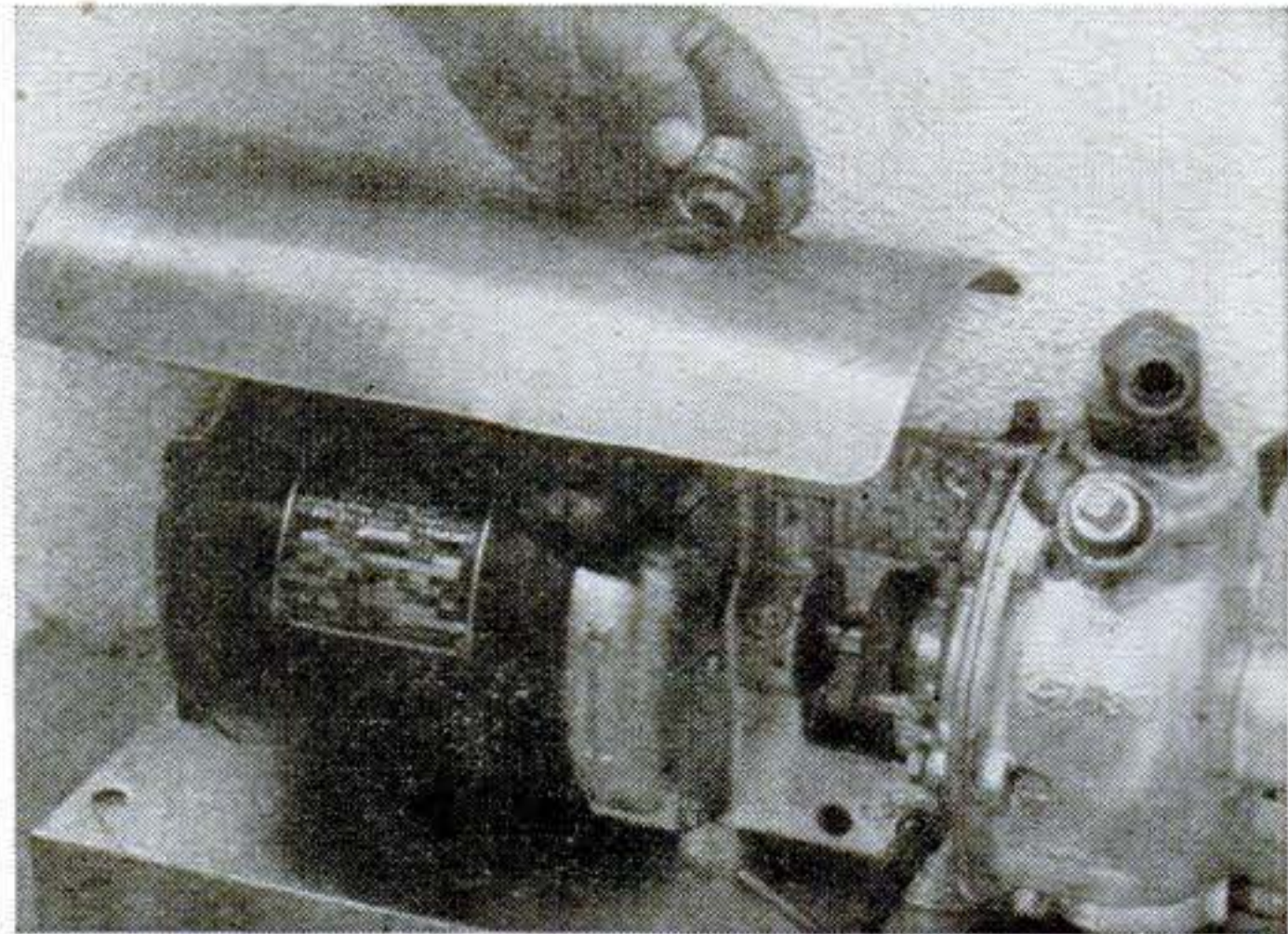
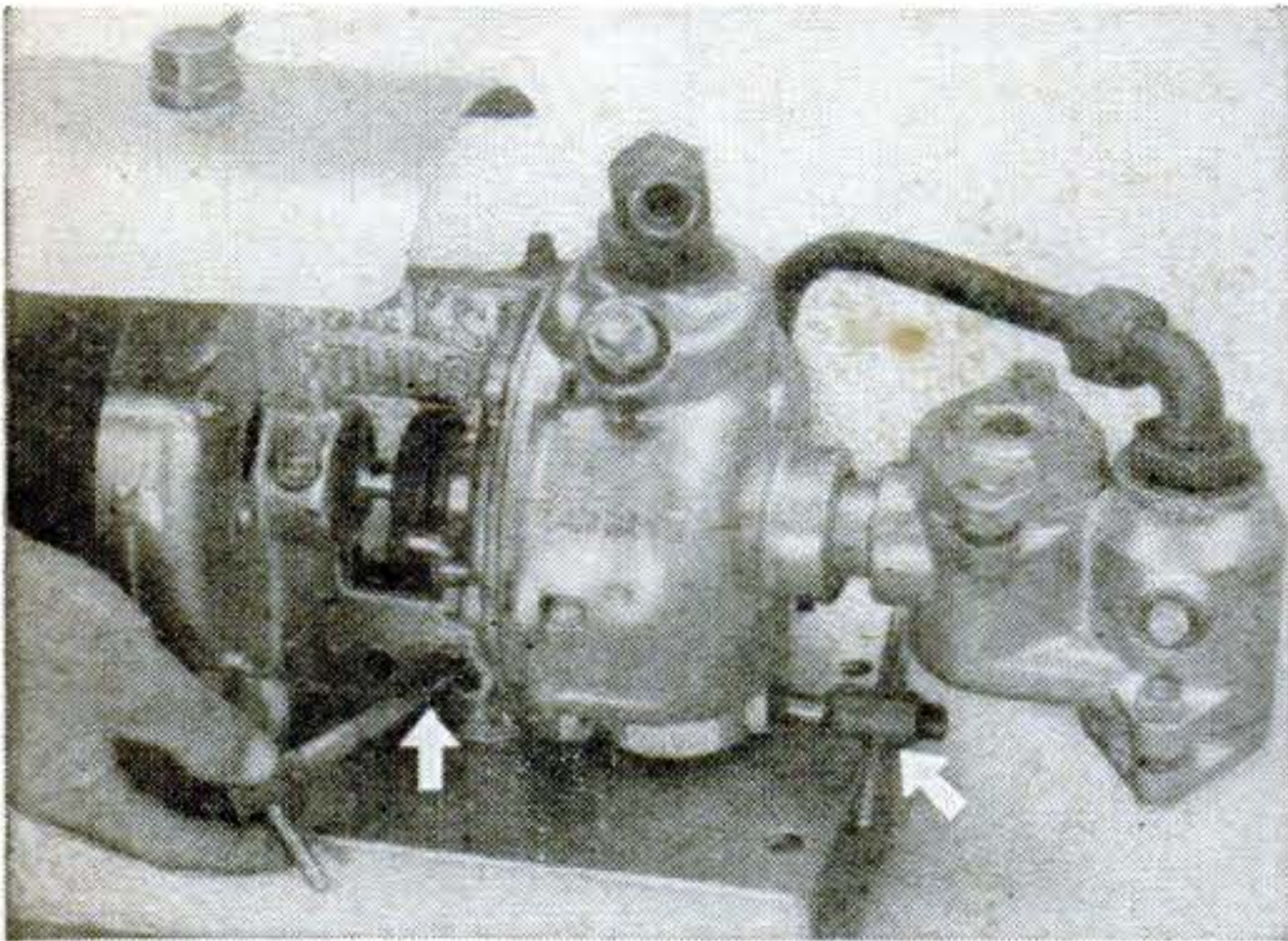
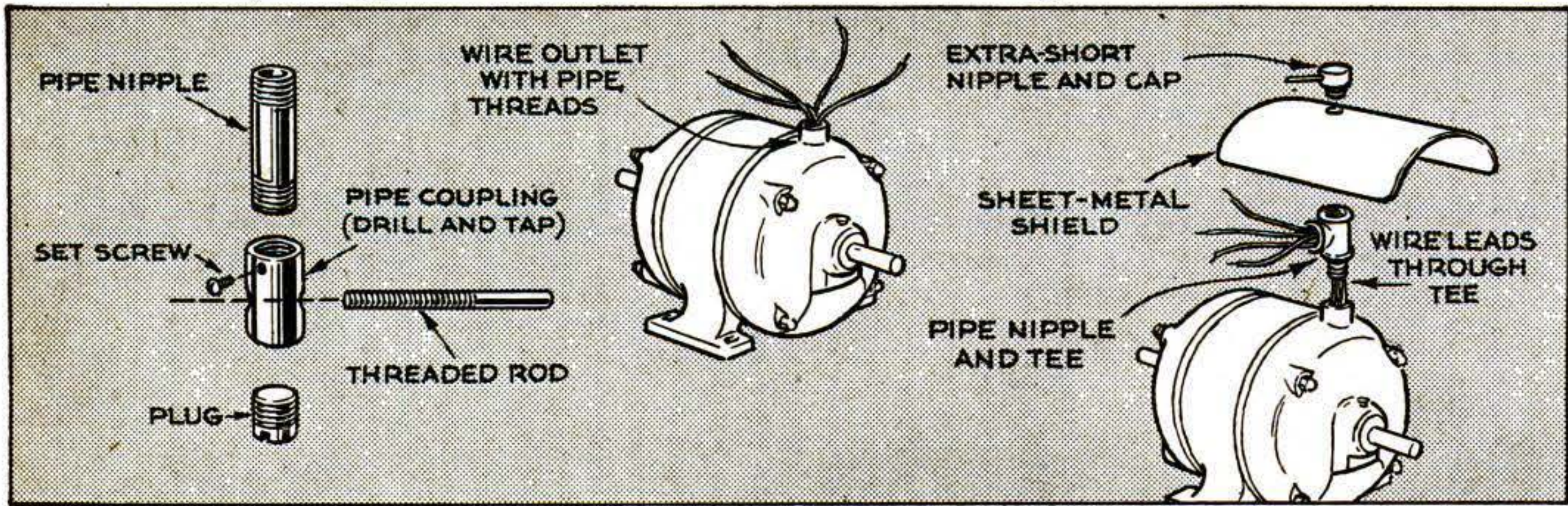

PUMPS installed in pits and other hard-to-reach places can be serviced more readily if equipped with these aids. At the left, an extension plug makes it easier to open a drain hole, and at the right a removable drip shield protects the motor. To avoid corrosion, use brass pipe fittings and sheet copper or aluminum for the shield.

Replacing a common pipe plug, the extension plug can be conveniently removed or installed by hand without a wrench. So that the pump frame or fittings will not keep the handle from turning, assemble each plug with a pipe nipple of suitable length, depending on the location. Couple the plug and nipple as indicated in the drawing.

If it is necessary to fill the plug nipples

to prevent leakage, use roofing cement or similar waterproof material for those on the discharge side. Fill those on the suction side with molten lead or other metal.

When the pump needs servicing, the drip shield is easily removed by unscrewing the short nipple and cap. A bracket made from a pipe nipple and tee is particularly suited to the type of motor shown, for the latter has a pipe-threaded wire outlet for convenience in mounting a pressure switch at this point if desired. Where this is the case, a pipe flange screwed on top of the pressure switch may be substituted for the bracket shown. A similar mount may be employed on motors having side outlets for the wire leads.—J. MODROCH.

Wall Studs Should Be Nailed Through Wide Sides

SOUND joints between wall studs and the plate are an essential framing requisite for either plaster or wallboard application, since weakness at this point leaves the surface without adequate support and is likely to result in cracks.

The joints will be weak if the nails are driven into the narrow face of the studs, as at A. Instead, nail only through the wide sides, as in B.

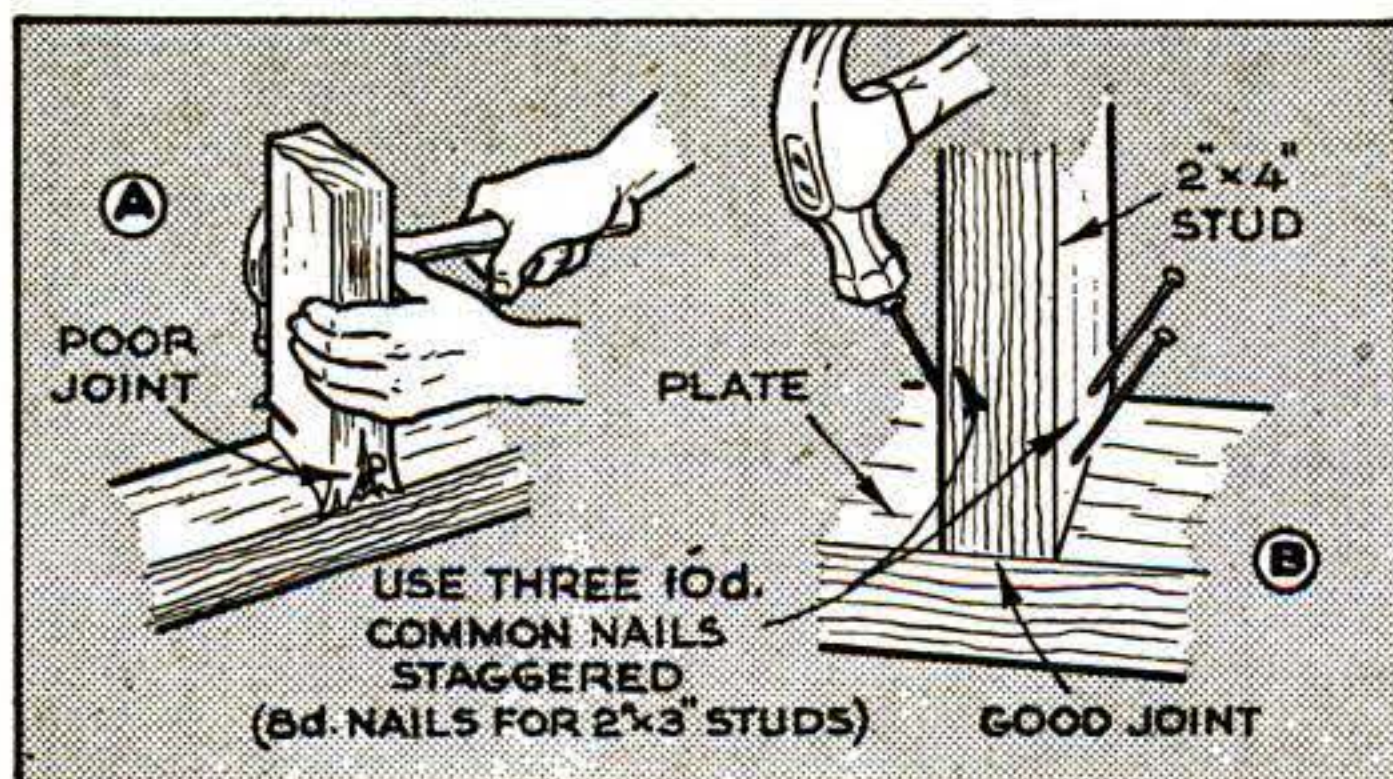

Fusible Links Shut Off Burner After Explosion

IF YOUR oil burner is not designed to shut down automatically in case of a "puff back" explosion, the illustrated setup will do the job—and prevent what might become a costly fire. Should the door be blown open or the flue wrecked by delayed ignition, the rising heat will melt a fusible link and allow the spring switch to open the burner circuit.

The switch should be a normally-open momentary-contact type. Connect the toggle arm to a wire that runs to the links, and tension the wire so that the switch is held closed, allowing the burner to operate. Install the switch in series with the hot side of the main line that runs to the burner.

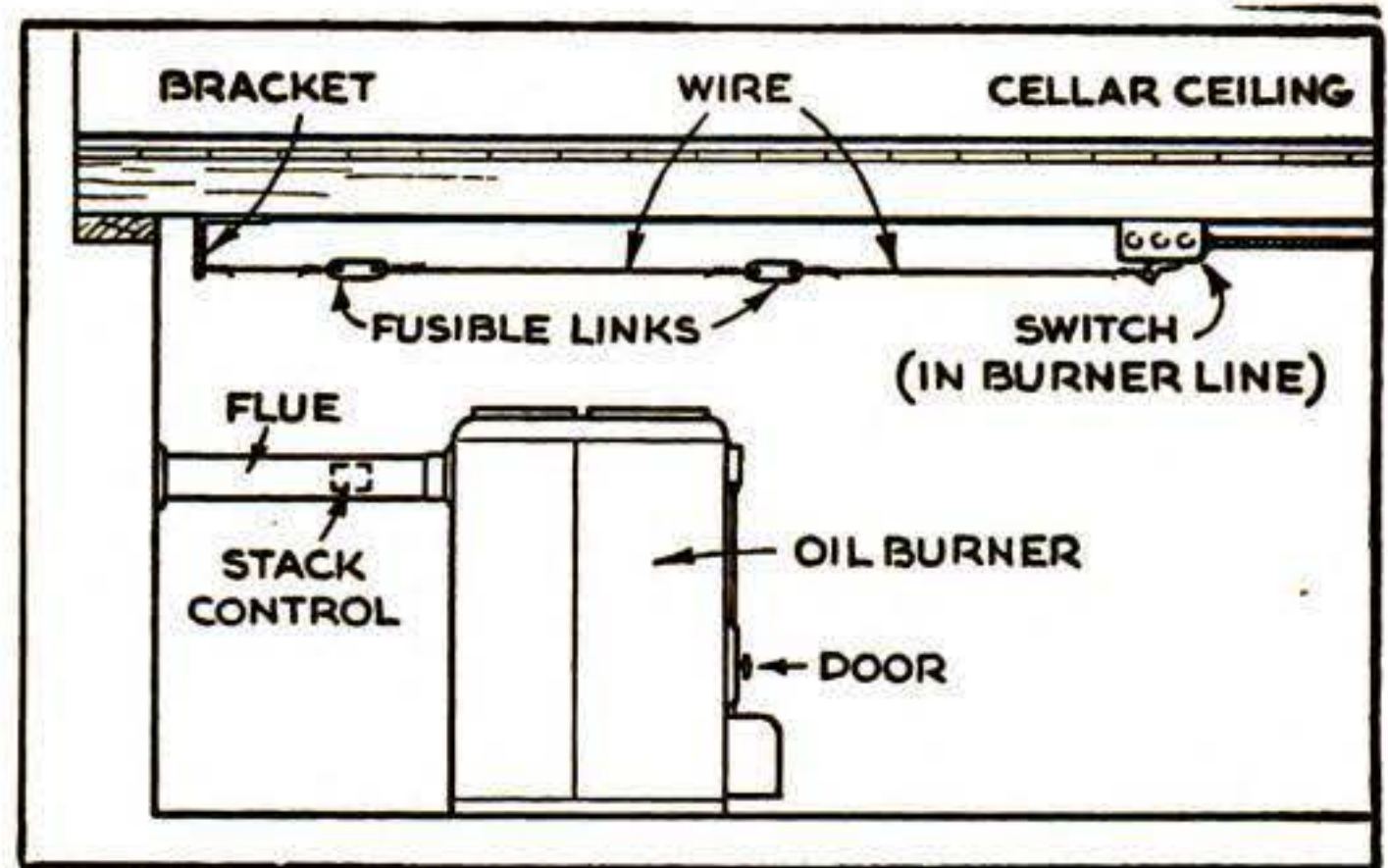

Use fuse links with a rated melting temperature of 160 deg., locating one directly over the furnace door and one or more over the flue pipe, depending on its length.

Tube Keeps Work on Sawhorse

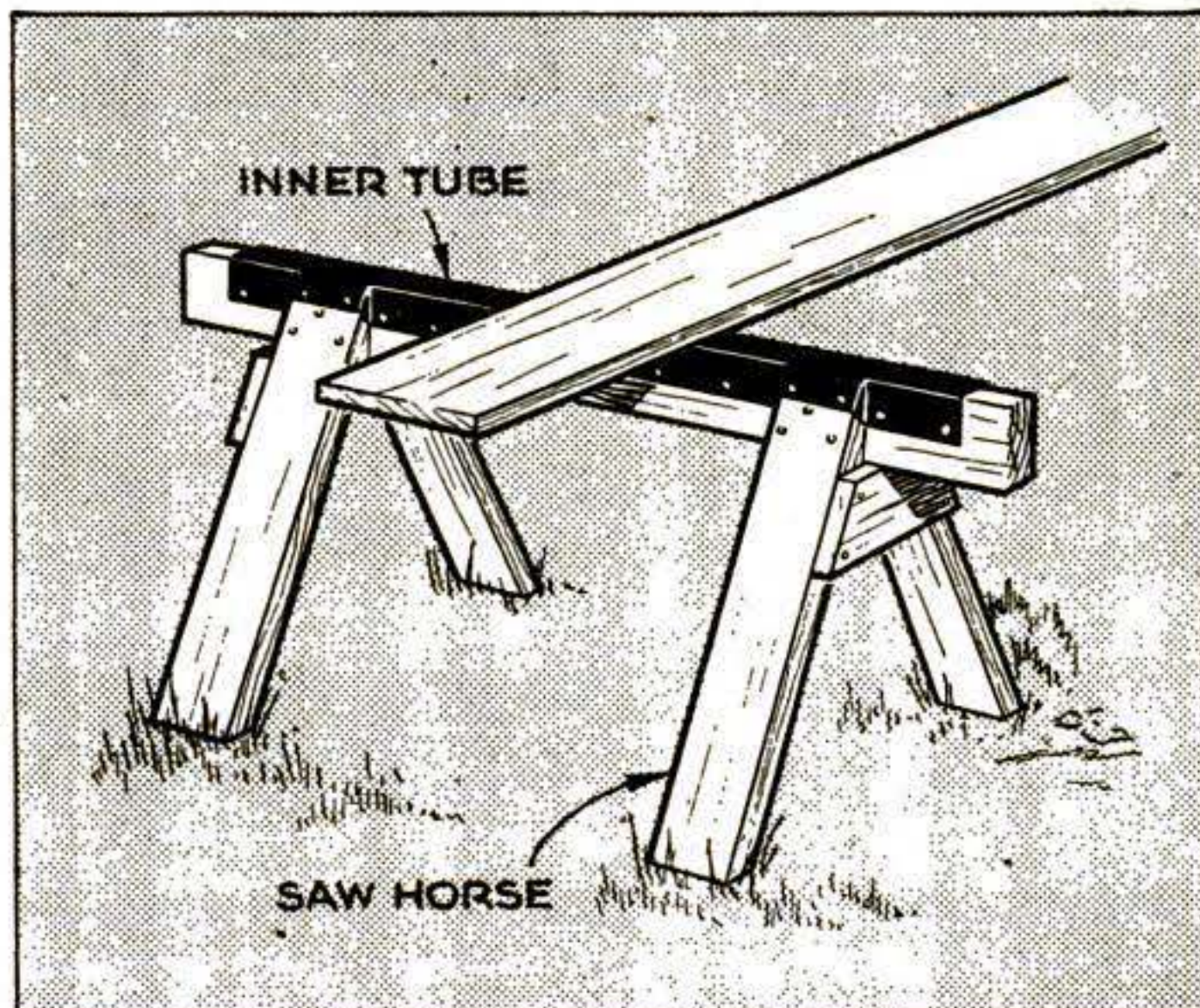

CARPENTERS and others will find that boards do not have such a tendency to slide and slip while they are being cut on sawhorses, if a length of inner tube is wrapped over the ridge of each horse and tacked to the sides with roofing nails. Rubber on the horse supporting the free end of the work is especially helpful.—W. B. EAGAN.

Clothespin Holds Lag Screw

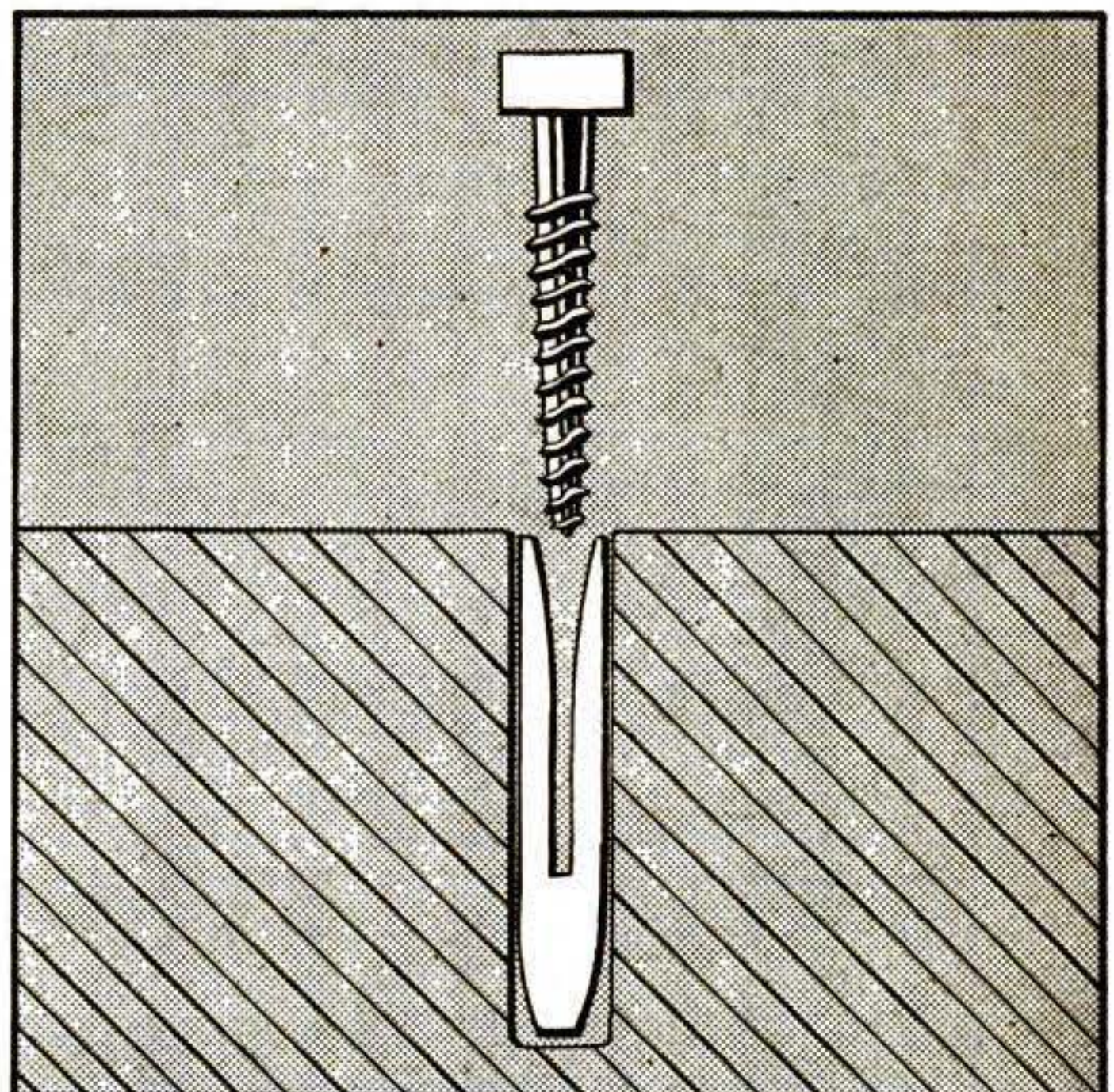

A CLOTHESPIN inserted in a hole as above makes it possible to anchor a lag screw firmly in cement. The head of the clothespin may be cut off to save the work of drilling a deeper hole.—RICHARD SALZER.

Batter Beater Cuts and Lifts "Skin" from Paint

USUALLY available in a dime store, a batter beater will often be found a handy tool in the home paint shop. It will quickly cut and lift the "skin" that forms on the surface of paint left standing in cans for some time. Excess paint drains through the tines, and the skin does not slide off as it will from a knife. If the beater is too wide to fit small cans, one or more tines can be cut from each side.—WILL THOMAS.

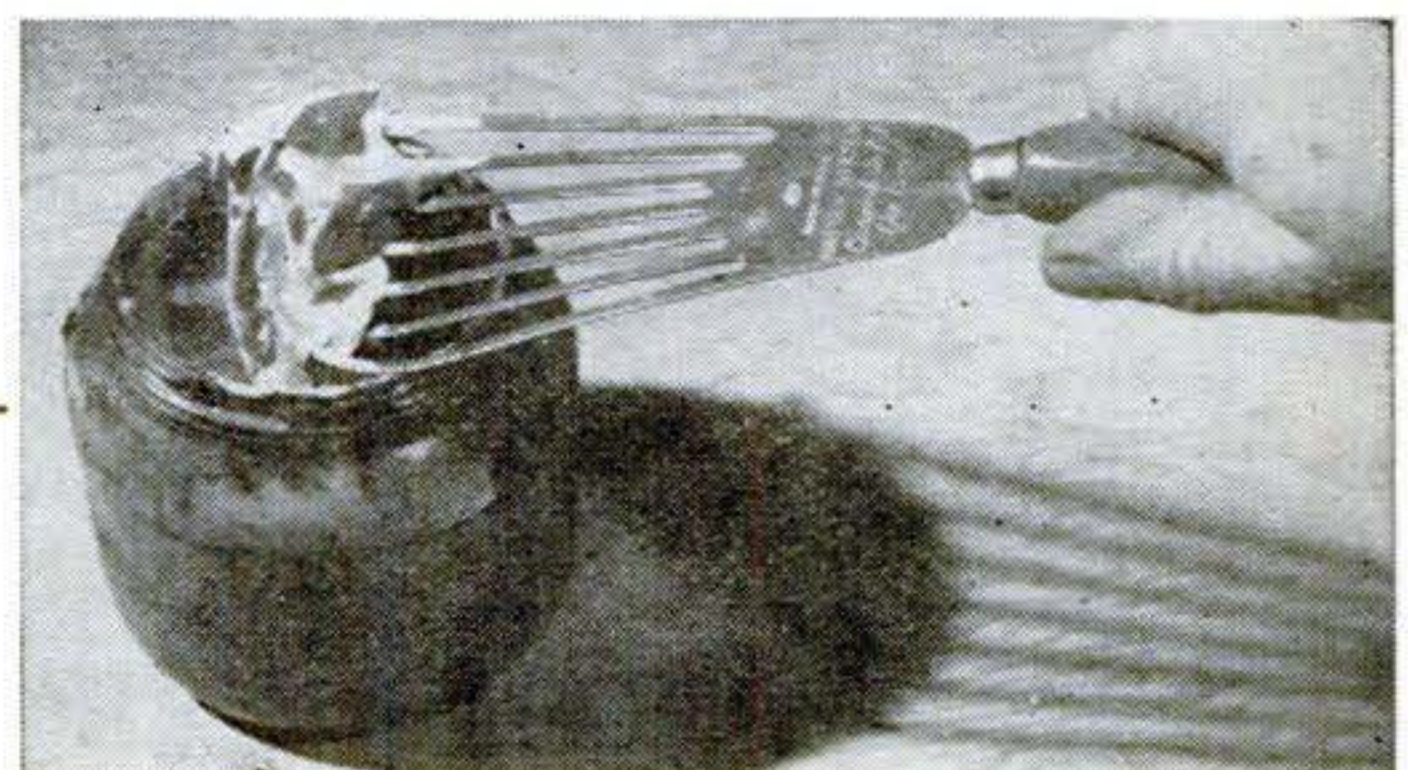

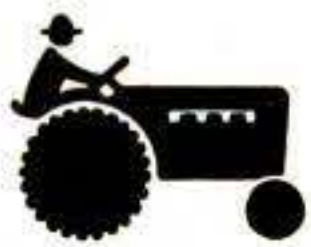

FOR EASIER FARMING

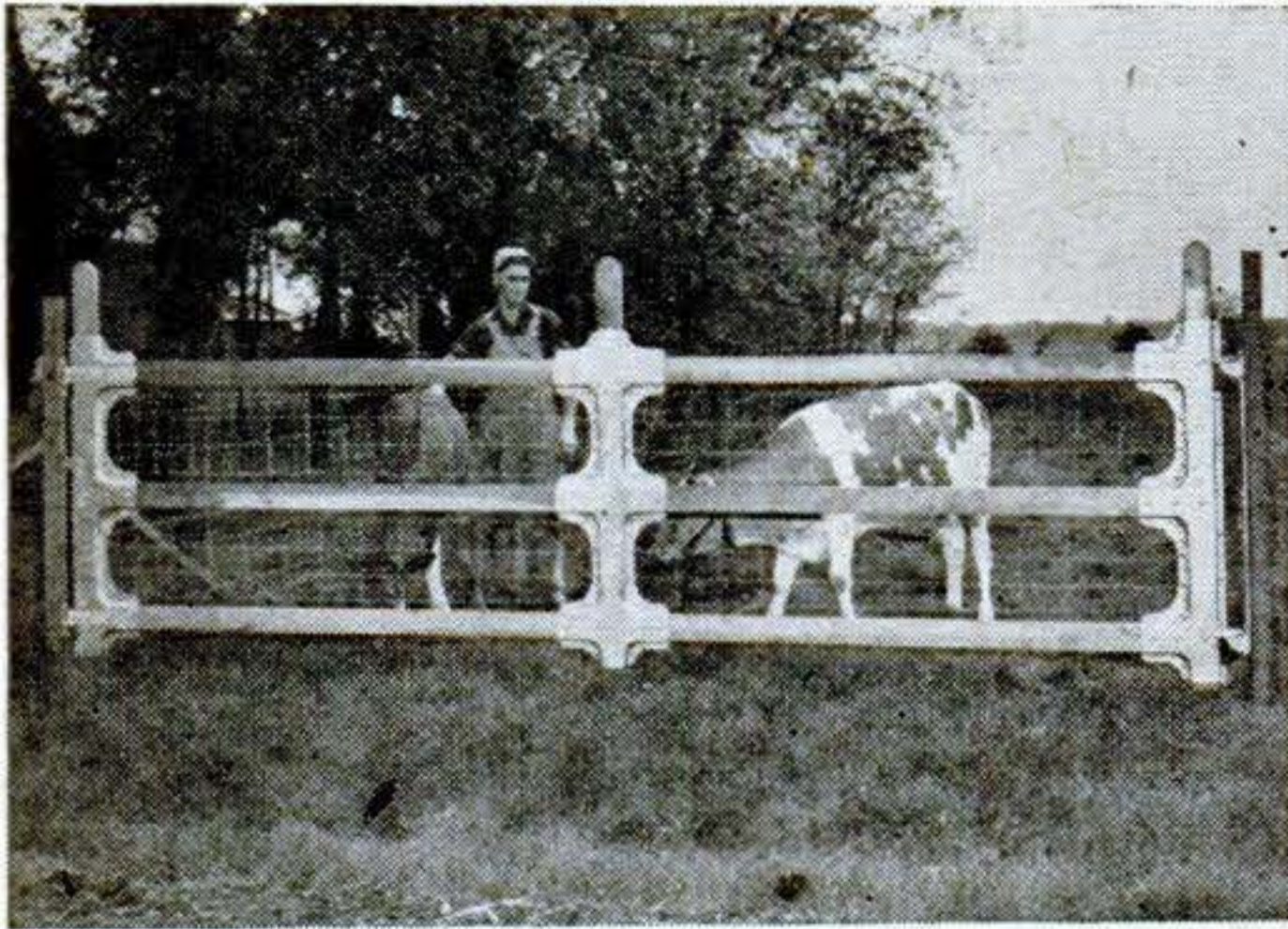

Gate Fits Any Opening. Steel members at the ends and center of this gate encase two-by-fours that may be cut so the length of the gate suits the opening. Supported by double hasp hinges, the gate swings in either direction and is held shut by a lever-operated latch. If the support post should sag, the gate may be realigned by a built-in leveler. The gate is made by Doughboy Industries, New Richmond, Wis.



Motorcycle Makes Hay. A motorcycle has been found useful in a hayfield at the proving ground operated by the Allis-Chalmers Manufacturing Company, near Elm Grove, Wis. Cylindrical bales made by the company's one-man baler are left in the field to dry, but must be turned at least once. This is the job of the motorcyclist. Riding slowly, he bumps the bales with the guard, turning them rapidly.

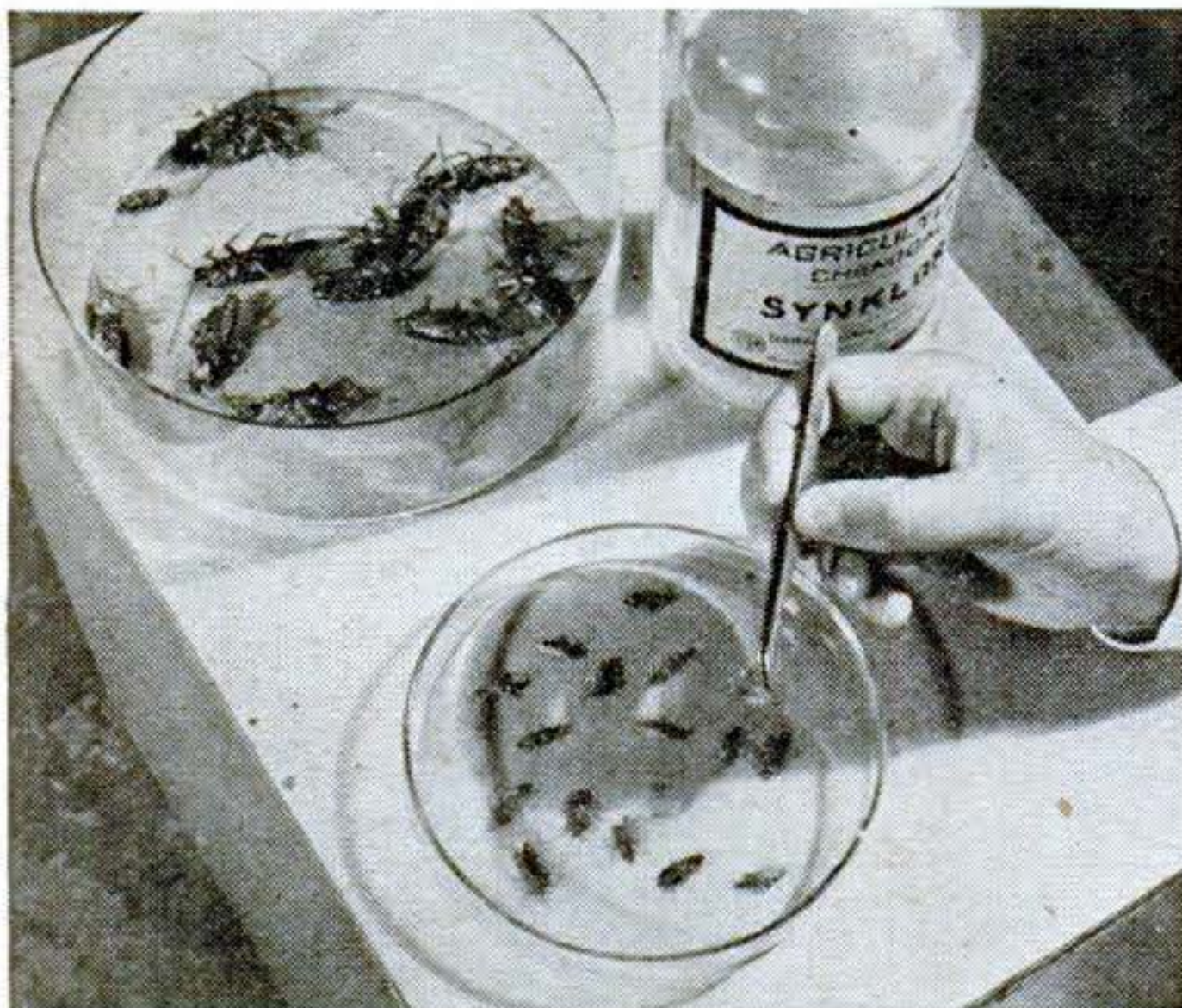

New Poison Kills Pests. Said to be four times as potent as DDT against certain insects, a new poison announced by the United States Rubber Company has been found especially useful against hordes of grasshoppers on western farm lands. Both a contact and stomach poison, it is called "Synklor" and has chlordane as the active chemical. Reported to be no more toxic to humans than DDT, the poison is available either as a liquid or a dust. A liquid form (above) quickly knocks out roaches.

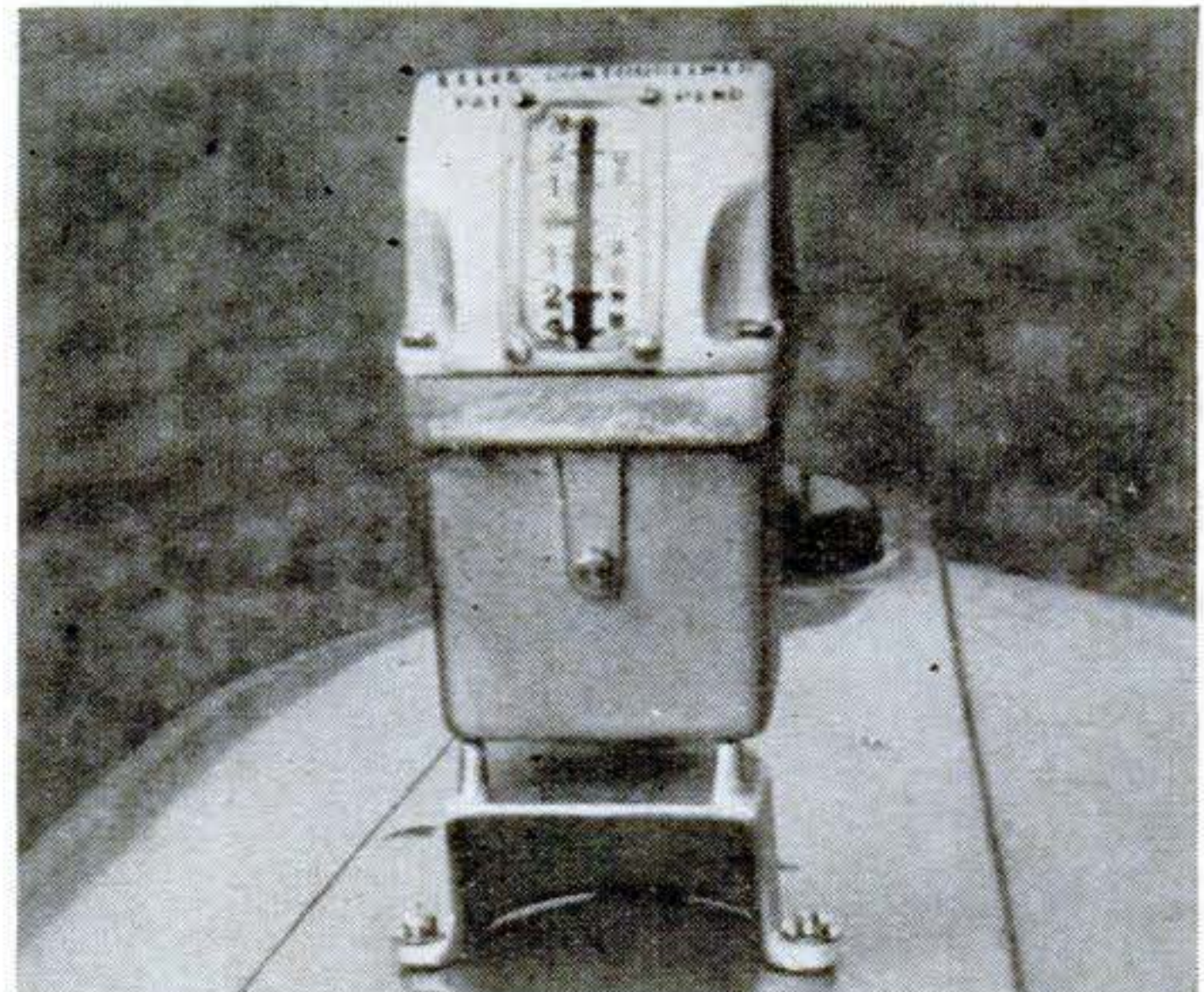

Aids Contour Plowing. An instrument marketed by the Ellis Sales Company, of Fairfield, Iowa, makes it unnecessary for a farmer to survey a field and put out stakes to guide his tractor along a contour line. Mounted on the tractor facing the driver, the instrument has a dial calibrated in percent of slope above and below the level, or contour, line. Thus, after locating his key contours, the farmer can just start plowing, correcting his wheels whenever the indicator hand moves off zero.



Alice Faye and Phil Harris, stars of NBC's Sunday night Fitch Bandwagon, (7:30 P. M., E. S. T.) and daughter Phyllis are photographed by "Baby Alice" with a Whittaker Micro 16

Christmas Shopping made simple

by Alice Faye

Every woman with children knows what a chore Christmas shopping is. The children and family come first, which leaves little time to think, let alone shop, for friends and relatives.

The other day when we were posing this picture for our family Christmas card, I got an inspiration which I'm passing along to you.

Baby Alice was so amused by Phil's Santa Claus outfit that she wanted to make a snapshot of her Santa Claus Daddy with our Micro 16. Then it came to me how simple and gracious it would be to give a number of our closest friends one of these amazing little cameras for Christmas.

I pass this shopping tip to you with the thought it may help solve your Christmas gift problems too.

YOU TOO can have and give...

a Merry Christmas and Many Happy Pictures

WITH THIS NEW, TINY PRECISION-BUILT CAMERA

IT'S THE PRESENT OF 1947! The Whittaker Micro 16 is *Everybody's Camera*. Even if you have *never* taken a picture in your life, you can get big camera results with this tiny precision-built camera. It's so easy to use even a 5 year old child like "Baby" Alice Harris can operate it.

YOU SEE YOUR PICTURE as it actually is in the "true-view" finder. Simply press the "sure shot" button and the tiny "eagle-eye" lens does the rest. No focusing or fussing. Fixed focus eliminates measuring distances.

MAKE NATURAL COLOR SNAPSHOTS having the same fidelity as black and white with the Whittaker Micro 16. It's precision-built for perfect picture taking.

SEE IT AT YOUR DEALER'S NOW, or mail the coupon for *free* descriptive folder and an actual Micro 16 black and white print (size 2½" x 3¼"), the same you take with this camera.

FAIR TRADED AT \$29.50

INCLUDES EXCISE TAX



- ROTARY SHUTTER
- 3-WAY APERTURE
- ACHROMATIC LENS
- TRUE-VIEW FINDER
- CHROME CASE



This Picture of Phil, Alice and Phyllis is actual size of the Whittaker Micro 16 color prints, only 40c each, 3 for \$1.00

Whittaker

PRECISION BUILT **Micro 16**



MADE BY MAKERS OF PRECISION AIRPLANE VALVES AND CAMERAS

WRITE FOR FREE FOLDER AND ACTUAL MICRO 16 PRINT

The Wm. R. Whittaker Co., Ltd., Dept. PS-12, 915 N. Citrus Ave., Hollywood 38, Calif. Please send me name of dealer nearest me, and folder describing Whittaker Micro 16, and *free* black and white print taken with this revolutionary camera. My name and address are:

NAME _____

STREET _____

CITY _____ ZONE _____ STATE _____

Acidproof glass-cloth-covered collector tube.

BE SAFE!

WHEN YOU BUY AN
OIL FILTER ELEMENT

Glass cloth trap will not deteriorate when attacked by engine oil acids,—an exclusive AC advantage.



**NOW
AVAILABLE
AT YOUR
AC
SERVICE
STATION**

Only the new "5-Star Quality" AC Oil Filter and Element has an acidproof glass cloth collector tube trap which prevents pollution of the oil stream and assures a free flow of clean engine oil.

You can't afford to take a chance. This glass cloth trap actually means that your oil is filtered *twice*—for your protection.

AC SPARK PLUG DIVISION • GENERAL MOTORS CORPORATION

WHEN YOU WANT A NEW OIL FILTER, GET A NEW AC "5-STAR QUALITY" OIL FILTER . . . and get these additional advantages

- POSITIVE END SEALS
- EXTRA STURDY BAIL
- MACHINED GASKET SEAT
- HIGH OUTLET RESTRICTOR POSITION
- EVEN DISTRIBUTION OF FLOW
- OUTSIDE-IN FLOW
- LONG FIBRE VIRGIN COTTON, RAM-PACKED
- EXTRA HEAVY METAL CASE
- EXTRA LARGE HEX HEAD DRAIN PLUG





On the Brighter Side . . .

BASKING in the brilliance of 82 new-type GE street lamps, Schenectady's Erie Boulevard, shown above, becomes the eighth brightest lighted street in America. One of three recent contributions to better lighting, the new system averages more than two foot-candles of light over the street.

The big bulb at right is also a GE development. Its 50,000 watts make it the world's largest incandescent lamp. Although used at present only for demonstration, it paves the way to bigger and better lights.

Largest and most powerful incandescent searchlight for sea duty is the 24-inch, 1,500-watt Westinghouse giant shown below. It would take some 90,000 household

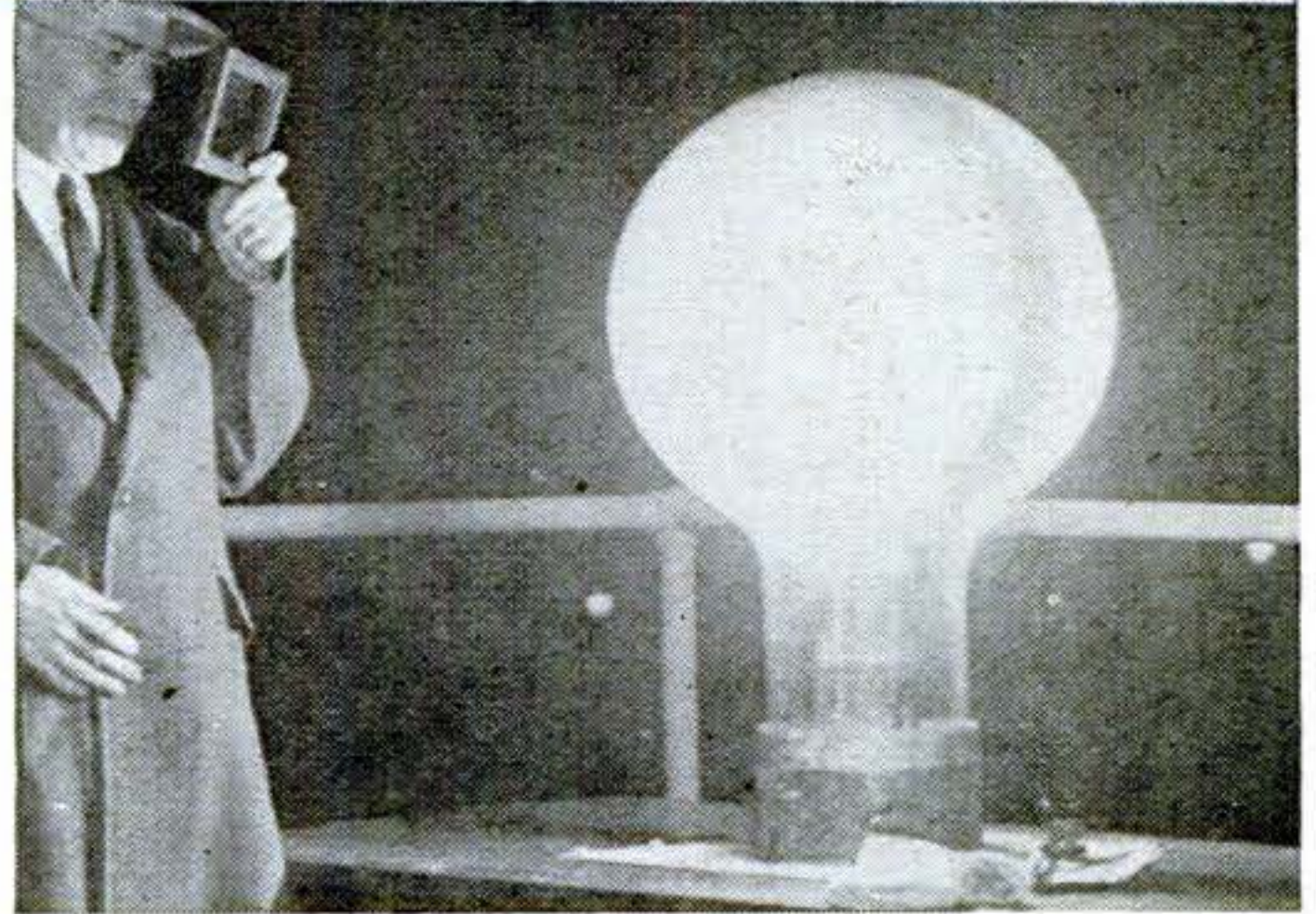

bulbs of 60 watts to equal the brilliance of its 5,850,000-candlepower beam. Designed to go atop the pilothouse of a new ocean liner, the aluminum-and-bronze light can be operated by a single remote-control lever.

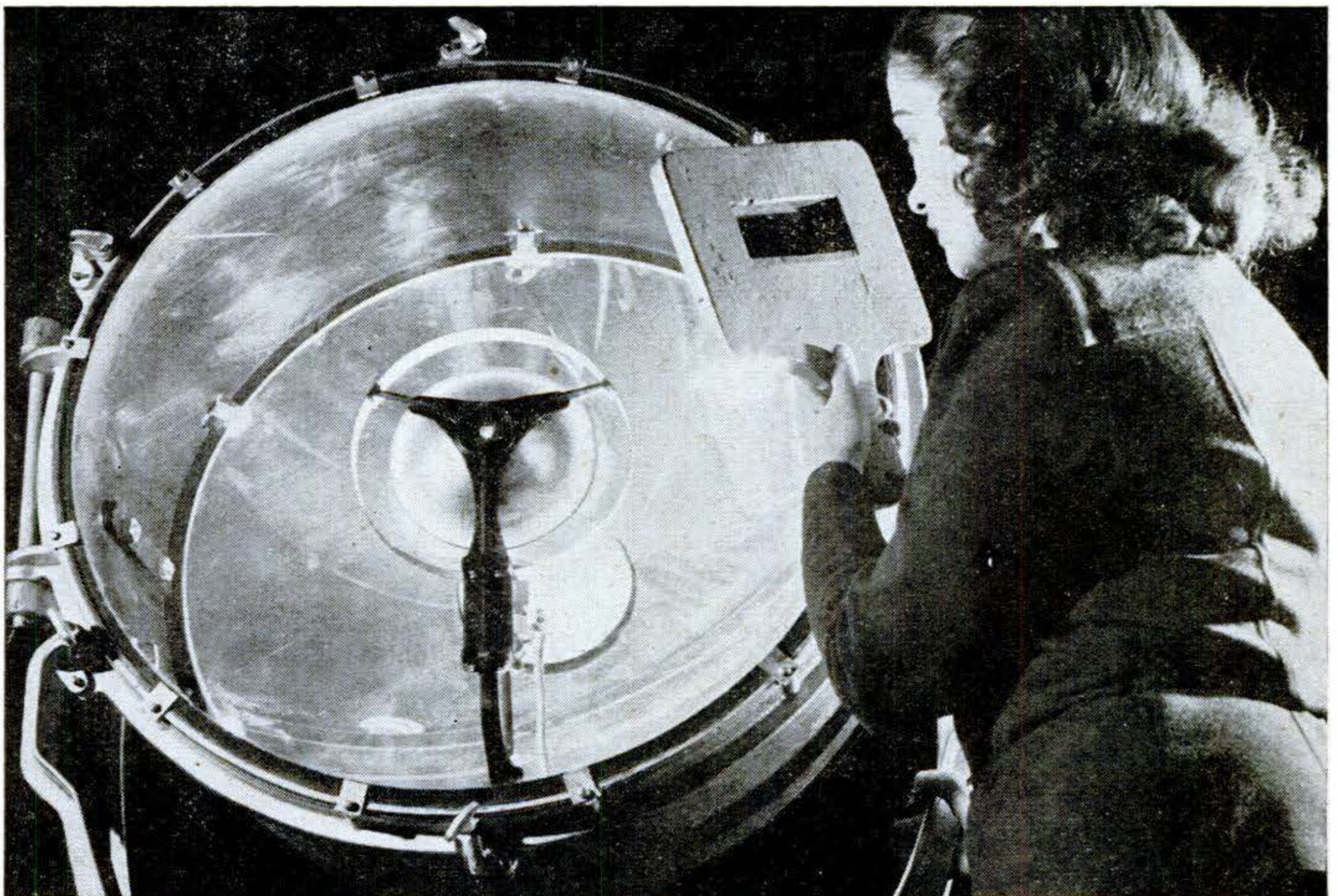

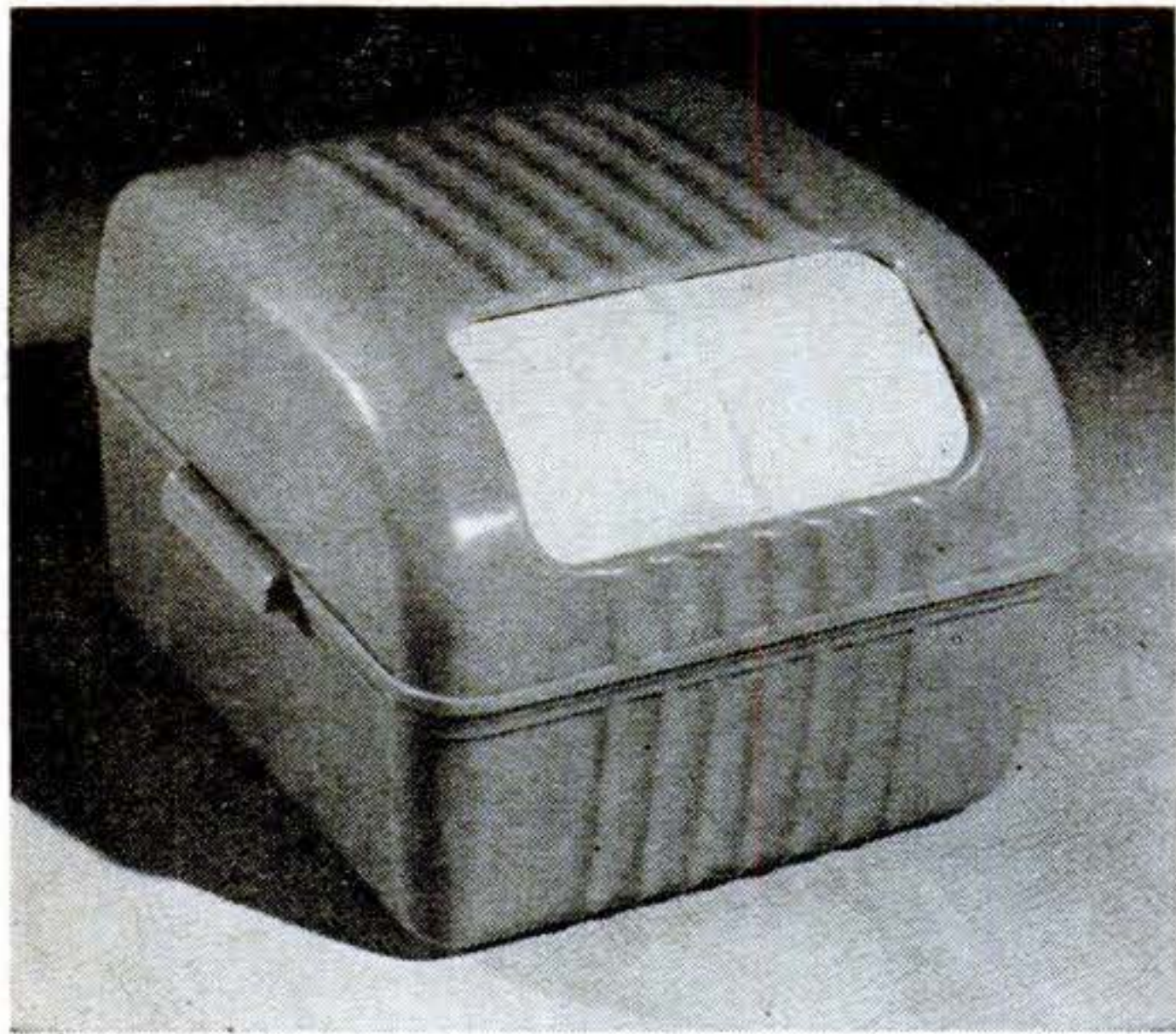

New Design Saves Space

THIS compact cleansing-tissue dispenser occupies about one-half the space required by conventional holders of the same capacity. Designed either for table use or for easy installation on kitchen or bathroom wall, the holder is molded of polystyrene in ivory, coral, and blue. It is made by Columbus Plastic Products, of Columbus, Ohio.



Battery Kept Up To Par

It's your own fault if the battery goes dead in this new electric hand lamp. Three colored balls tell at a glance when the battery must be recharged. Indicating specific gravity, all three appear level behind their transparent window when battery is fully charged. Drop of green ball means five percent discharge; white, 50 percent; red, 95 percent. For recharging, battery need not be removed, as charger can be plugged in. Made by U-C Lite, of Chicago, the lamp throws a 2,500-ft. beam.



Easier Color Printing

EKTACOLOR, a new negative color film developed by Eastman Kodak, is going to take a couple of the headaches out of making color prints. It eliminates the need for masking and for separation negatives.

The Ektacolor process is able to do this by using color couplers. These provide color correction as the film is developed, producing a negative image combined with positive color "masks."

With most previous color films you must work from a positive transparency, and color correction is achieved by making one or more low-density, negative images as masks that then are bound in register to the transparency. Ektacolor completely eliminates this step.

The making of separation negatives is another tedious step in producing color prints from positive transparencies by the dye transfer method, since such negatives are needed to produce printing matrices. This process is also eliminated by the new negative color film, providing a second major saving of time and materials.

Working from the Ektacolor negative with color filters, positive printing matrices may be made directly on another new Kodak product—Pan Matrix film. Thus, in effect, Ektacolor provides in one film a set of corrected color negatives.

Black-and-white prints for use as proofs may also be made directly from Ektacolor negatives on special paper.

Intended primarily for professional use with artificial light, Ektacolor is designed for processing in a photographer's own studio. It will be supplied in standard film sizes for use in conventional cameras, and is expected to be available early in 1948.

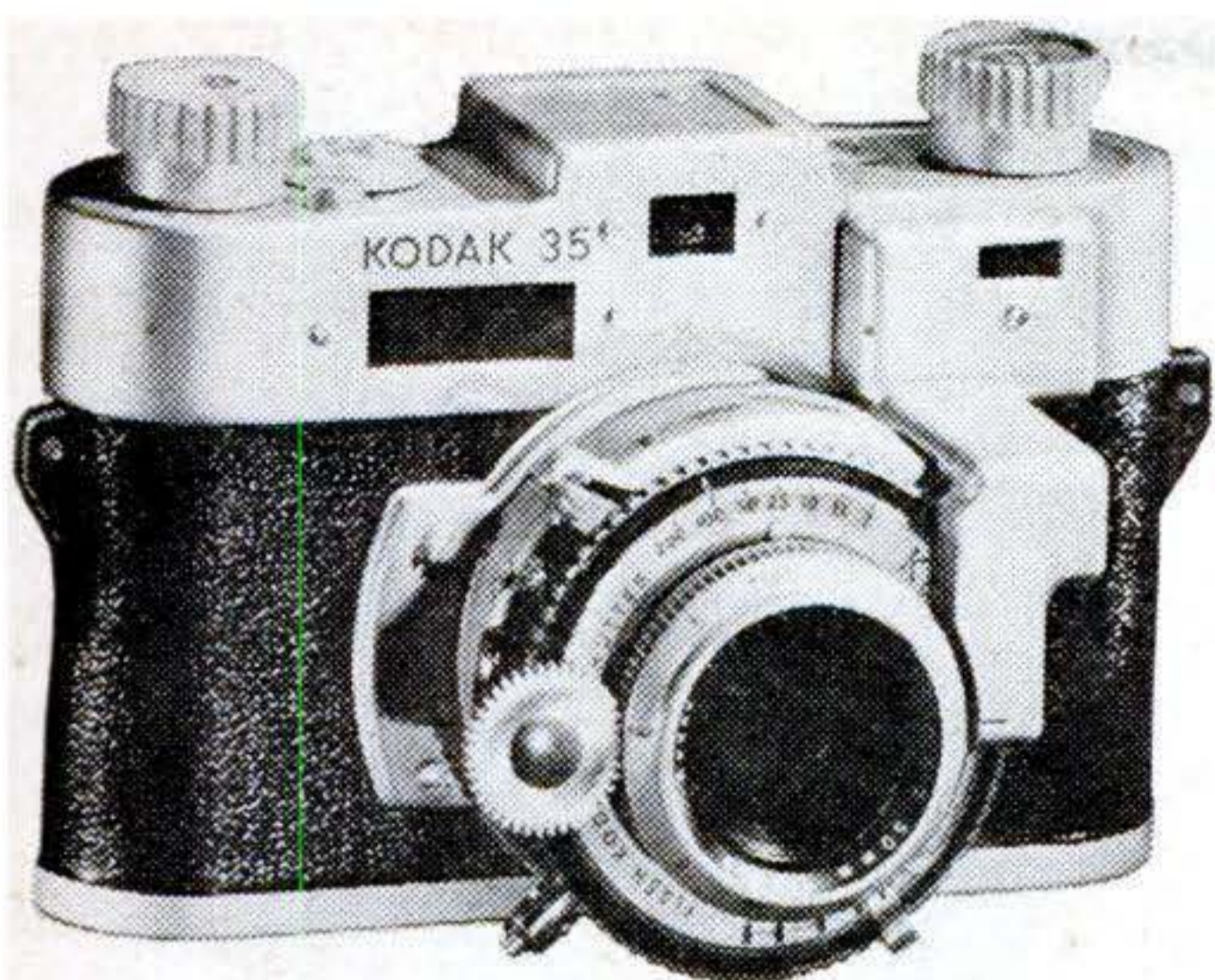

For the miniature fan...

A KODAK 35 CAMERA WITH RANGE FINDER. Brilliant 4-element $f/3.5$ lens, *Lumenized* to block ghost images; 1/200-second Kodamatic Shutter; built-in flash synchronization. Modern refinements include double-exposure prevention, automatic film stop and shutter-setting. Moderately priced.

**One of them is
just right for YOU**

For the artist-photographer...

THE KODAK REFLEX CAMERA. Twin taking and viewing lenses are $f/3.5$'s, *Lumenized* to cut flare. Big, brilliant image makes it easy to study composition; tells you when focus is razor-sharp. 1/200-second Kodamatic Shutter; built-in flash synchronization. Sturdy cast-aluminum body. The most for your money in the fine-reflex field.

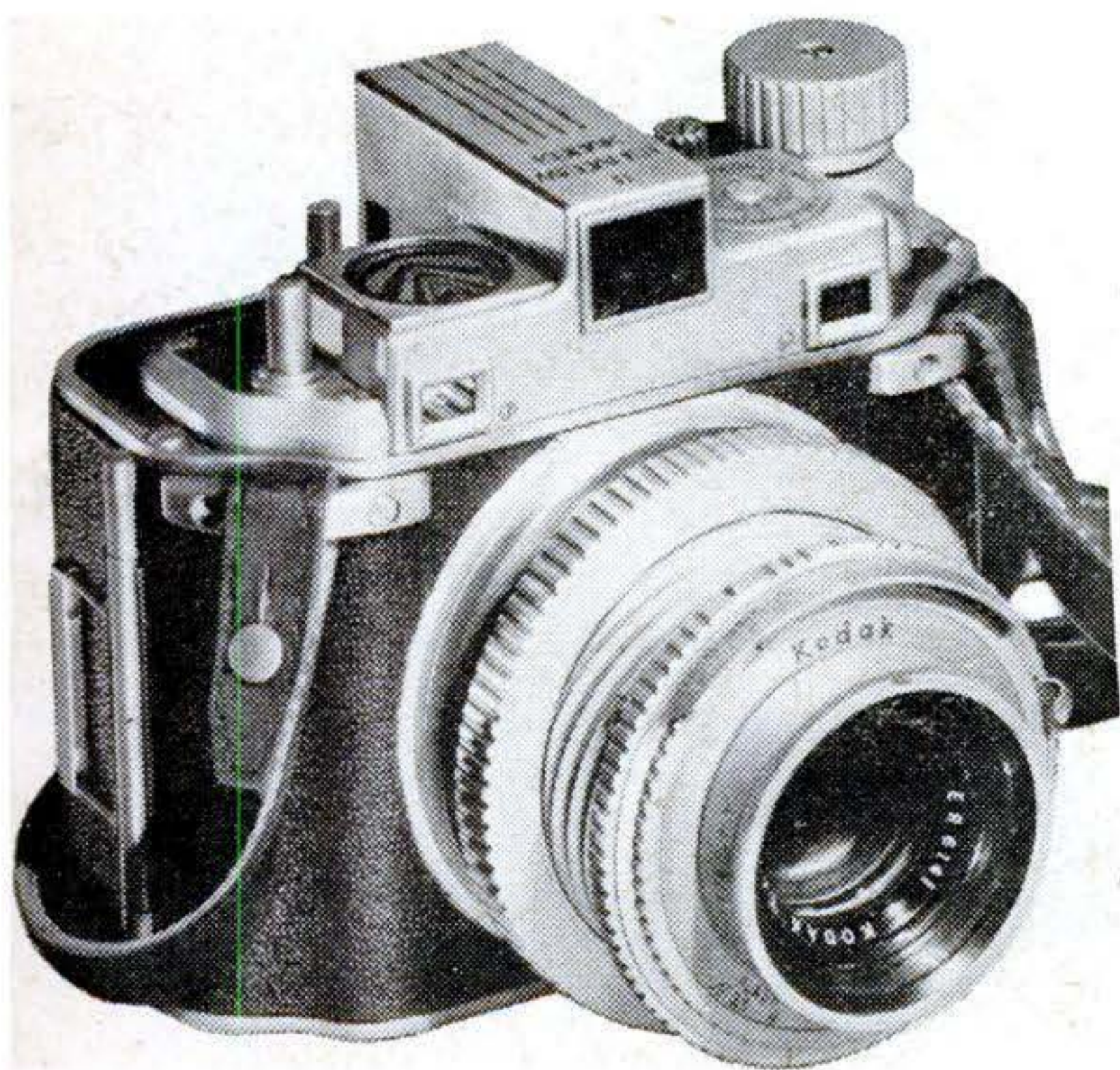

For the critical worker...

KODAK MEDALIST II CAMERA. Kodak Ektar 100mm. $f/3.5$ Lens—*Lumenized*—unsurpassed in correction for definition and color. Supermatic (1/400) Shutter synchronized for flash. Instant focus with coupled split-field range finder. Uses rolls, adapts to packs, sheets, or plates; pictures, $2\frac{1}{4} \times 3\frac{1}{4}$. See your Kodak dealer.
EASTMAN KODAK CO.,
ROCHESTER 4, N. Y.

Kodak

**"I know
what I want**

**—even if I have
to buy it myself"**

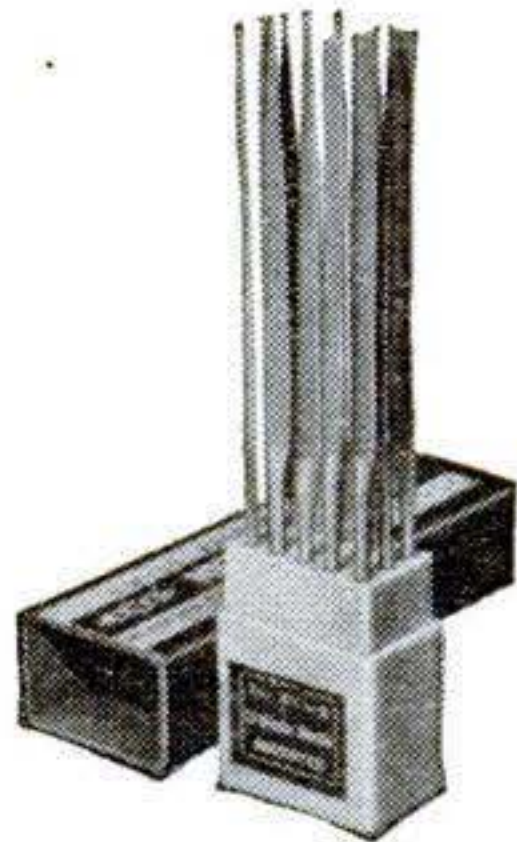
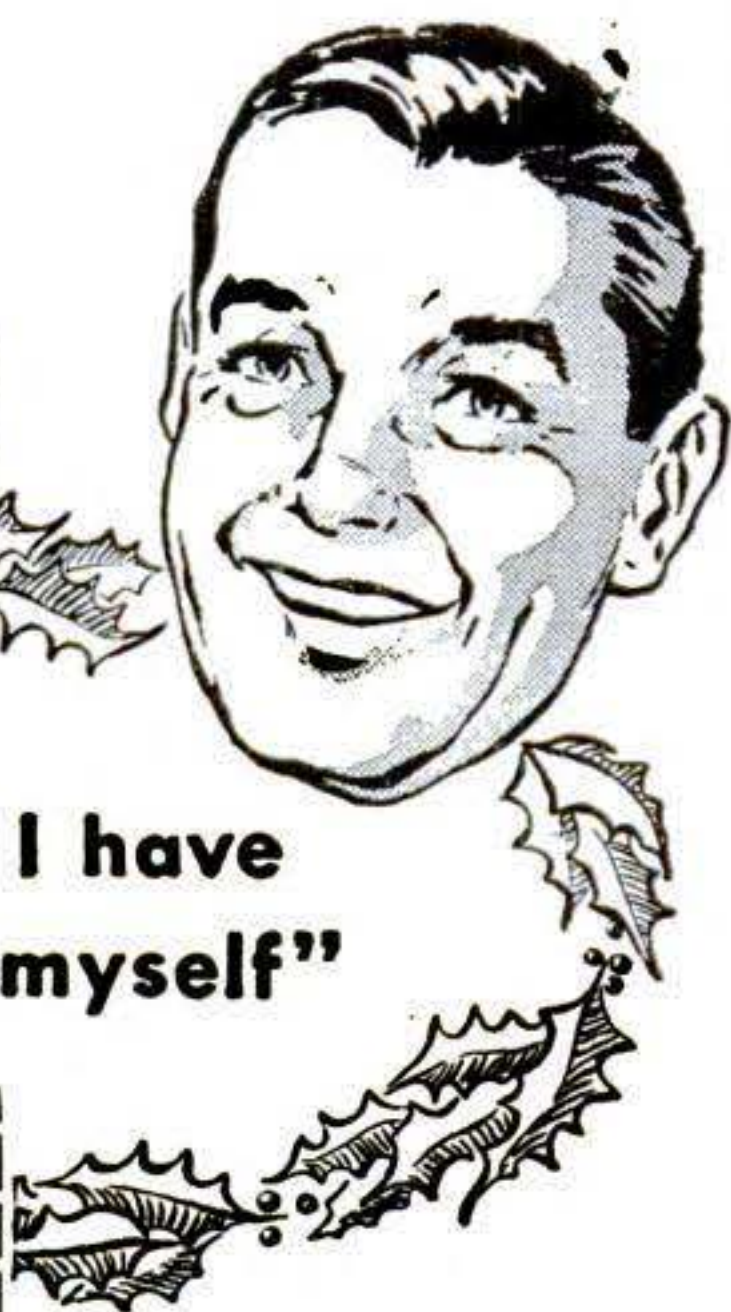

NEXT to the products of his own handcraft, fine tools are the average "basement hobbyist's" greatest source of pride. Any one of these outstanding high-quality kits of Nicholson craftsmen's files will fascinate him.

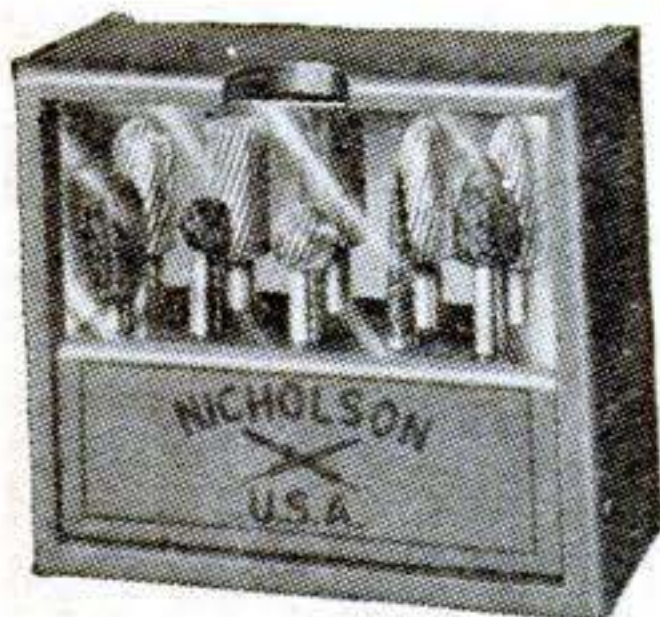

Nicholson X.F. Swiss Pattern Files in handsome orange-and-blue plastic case . . . 12 assorted Round Handle Needle Files; lengths 4", 5½" and 6¼", according to cuts 0, 2, 4 and 6.



Nicholson Rotakit containing ten assorted Nicholson Hand Cut Rotary Files and Ground Burs with standard ¼" shank for use in regular electric power tool, flexible shaft or drill press.

Nicholson Rotaset containing 18 assorted Nicholson Hand Cut Rotary Files and Ground Burs with ⅛" shank for use in small-size electric power tool or flexible shaft.

OBTAINABLE THROUGH GOOD HARDWARE STORES AND INDUSTRIAL SUPPLY HOUSES



NICHOLSON FILE CO.
19 Acorn St., Providence 1, R. I.
(In Canada, Port Hope, Ont.)



**NICHOLSON
FILES** FOR EVERY PURPOSE

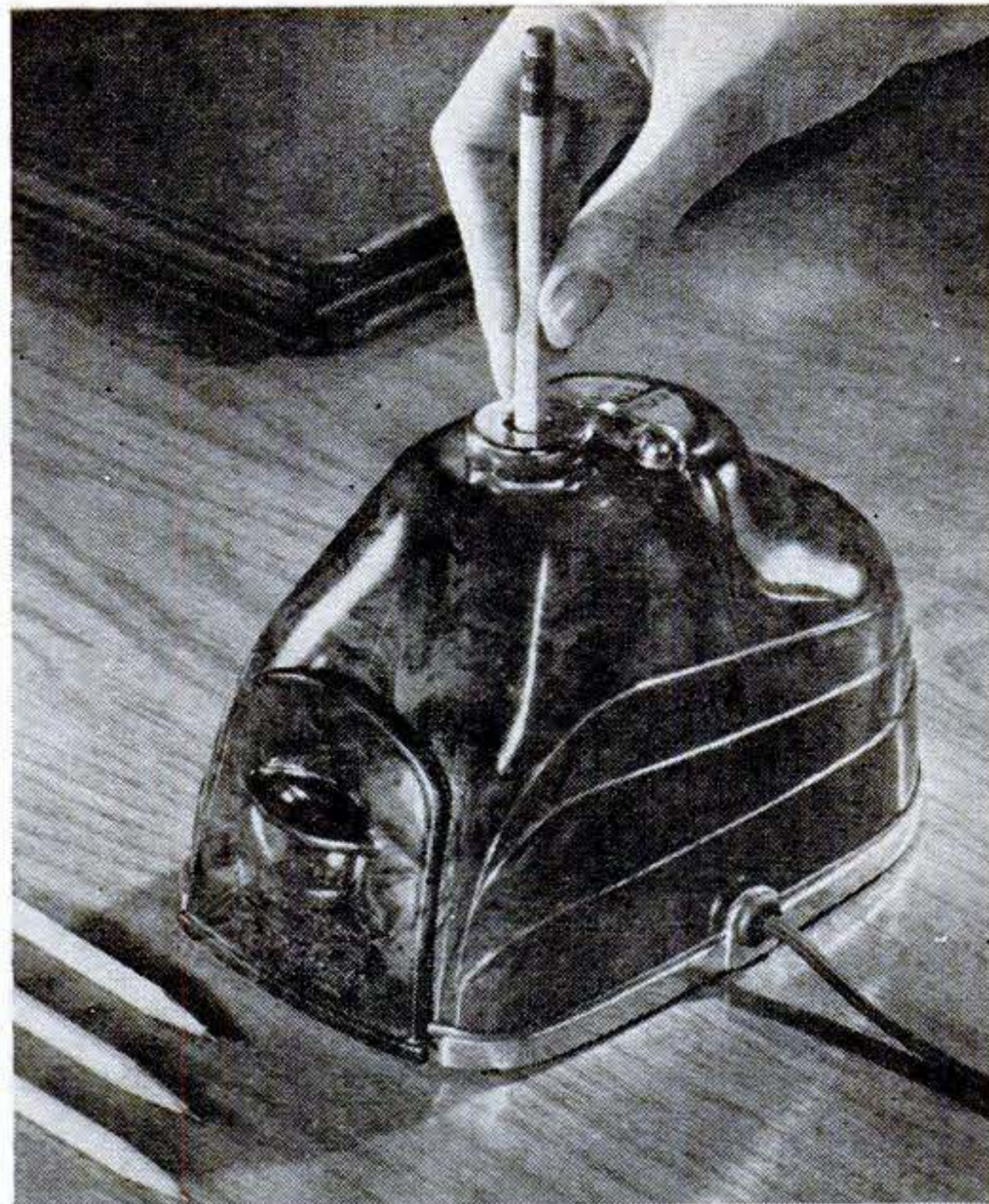

Power Sharpens Pencils

IT DOESN'T take long to put a point on a pencil with this electric sharpener. Made by the Bert M. Morris Co., of Los Angeles, it points graphite or colored pencils to any of three grades of sharpness, operates on either AC or DC, and has a Tenite exterior of modern design. A draftsman's model is also made that sharpens only the pencil's wood.

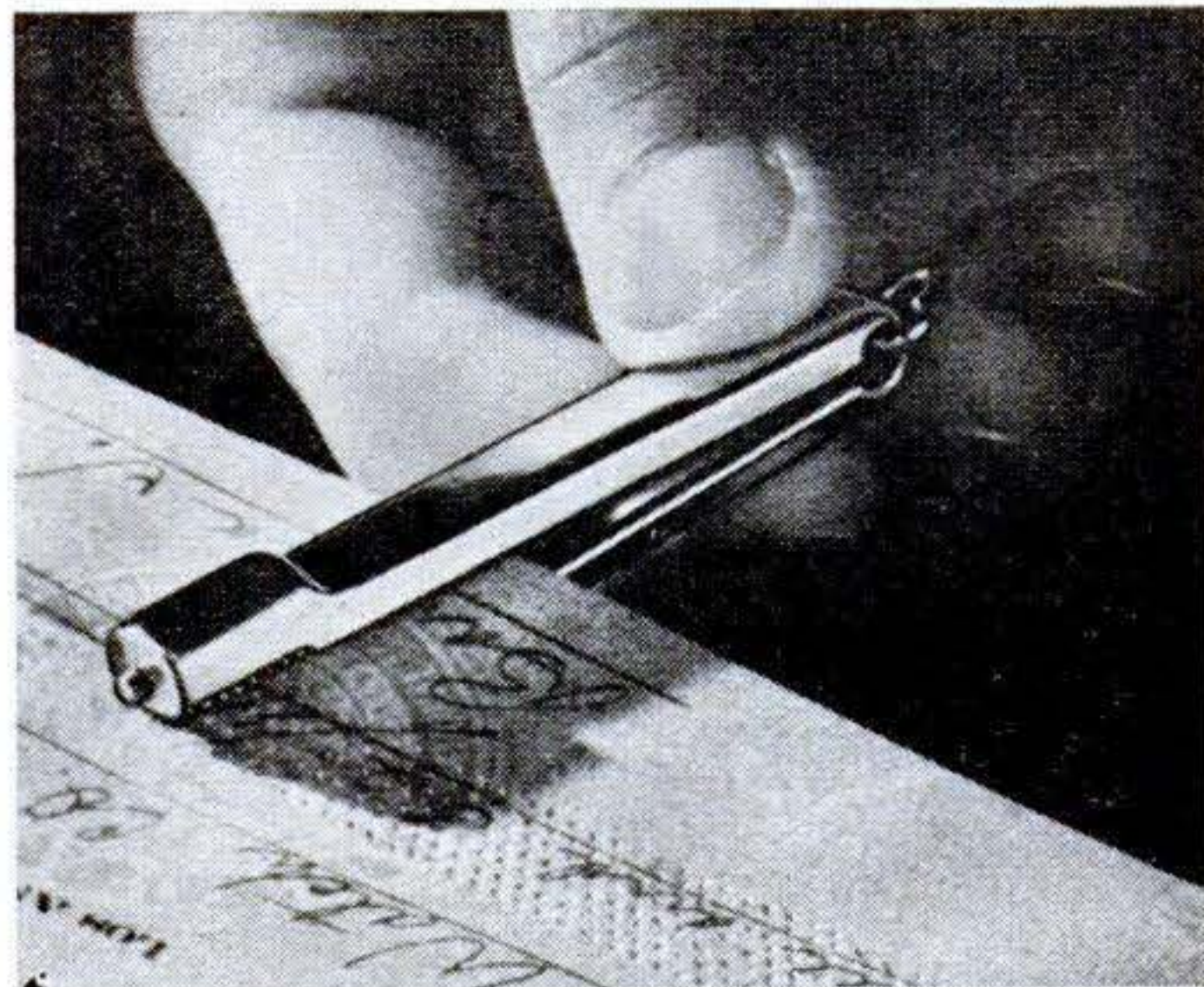

Punch Protects Checks

A POCKET-SIZED check perforator not much larger than a small pair of tweezers is made by the Kaw Mfg. Co., of Long Beach, Calif. Tiny spiked rollers on the ends of the arms puncture the paper from both sides when rolled along a check.

CREATING DESIGNS IN
PLASTIC
IS A GRAND FEELING



IT'S A
GRAND
FEELING,
TOO....

WHEN YOUR CAR IS
CUSHIONED WITH MARFAK
CHASSIS LUBRICATION

THAT CUSHIONY FEELING LASTS LONGER WITH **MARFAK!**

It's a grand feeling to watch those artistic plastic designs take form. It's the same feeling of satisfaction you get when you drive your smooth-riding *Marfak* lubricated car.

• Cushiony driving and handling ease is a sure sign that *Marfak* sticks to its work, with bearing surfaces scientifically protected against wear . . . for a thousand miles and more. *Marfak* is designed to resist wash-out, jar-out and squeeze-out. Applied by chart, never by chance. Ask your Texaco Man to give your car that "*Marfak* feeling" today.



THE TEXAS COMPANY
TEXACO DEALERS IN ALL 48 STATES

TUNE IN: TEXACO STAR THEATER presents the TONY MARTIN show every Sunday night
METROPOLITAN OPERA broadcasts every Saturday afternoon. See newspaper for time and station.

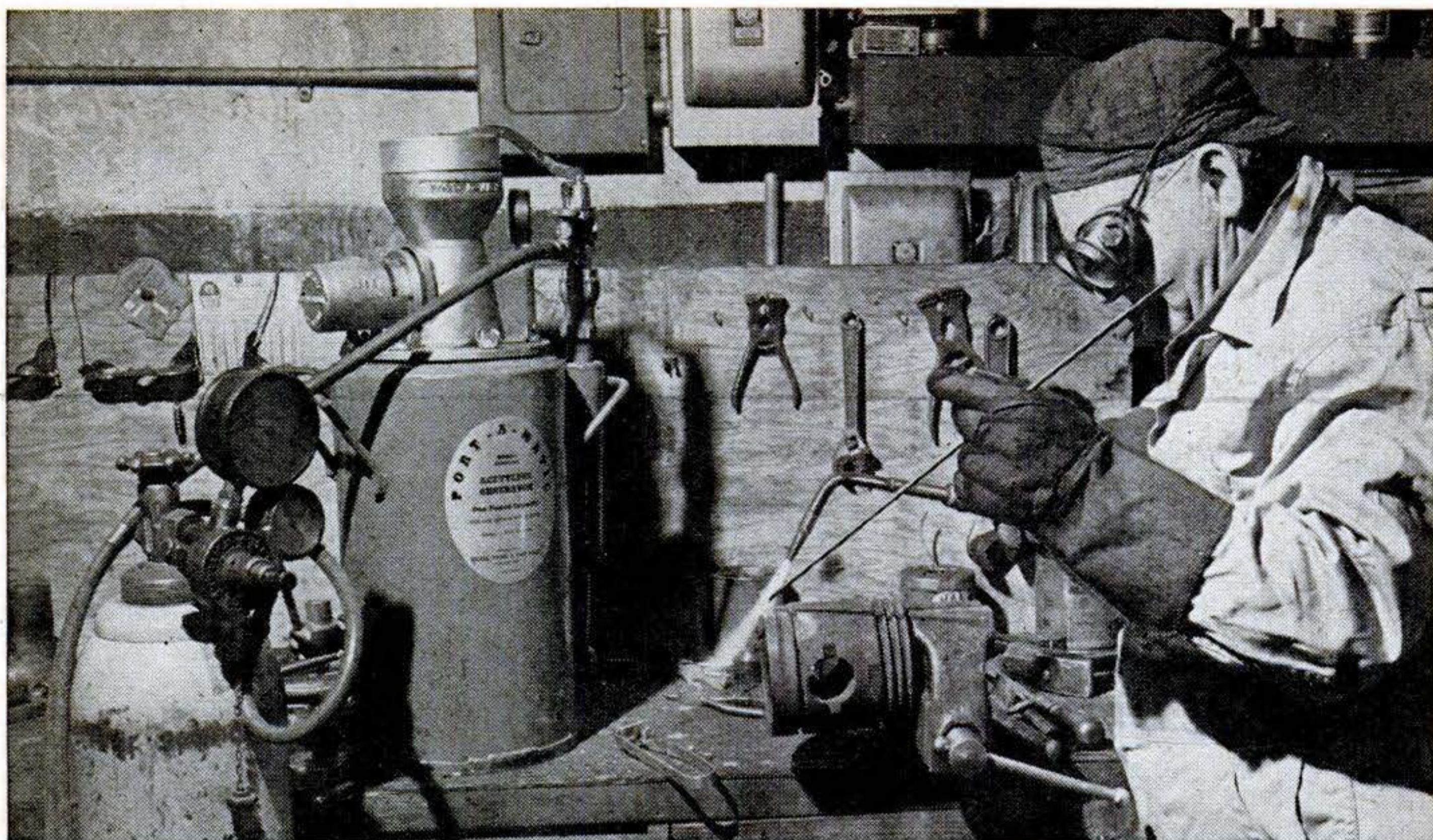

Portable Gas Generator

A PORTABLE acetylene-gas generator of new design, the Port-A-Matic, supplies fuel for an oxyacetylene welding torch safely, inexpensively, and just where it's needed.

Easy to carry or lift to a bench, the model shown weighs only 25 pounds. While in use it can be knocked over or even turned upside down without fear of explosion, the maker says, since baffles keep water from reaching the carbide hopper.

13.5% more accuracy without winding

that's what you get with the

CROTON AQUAMATIC

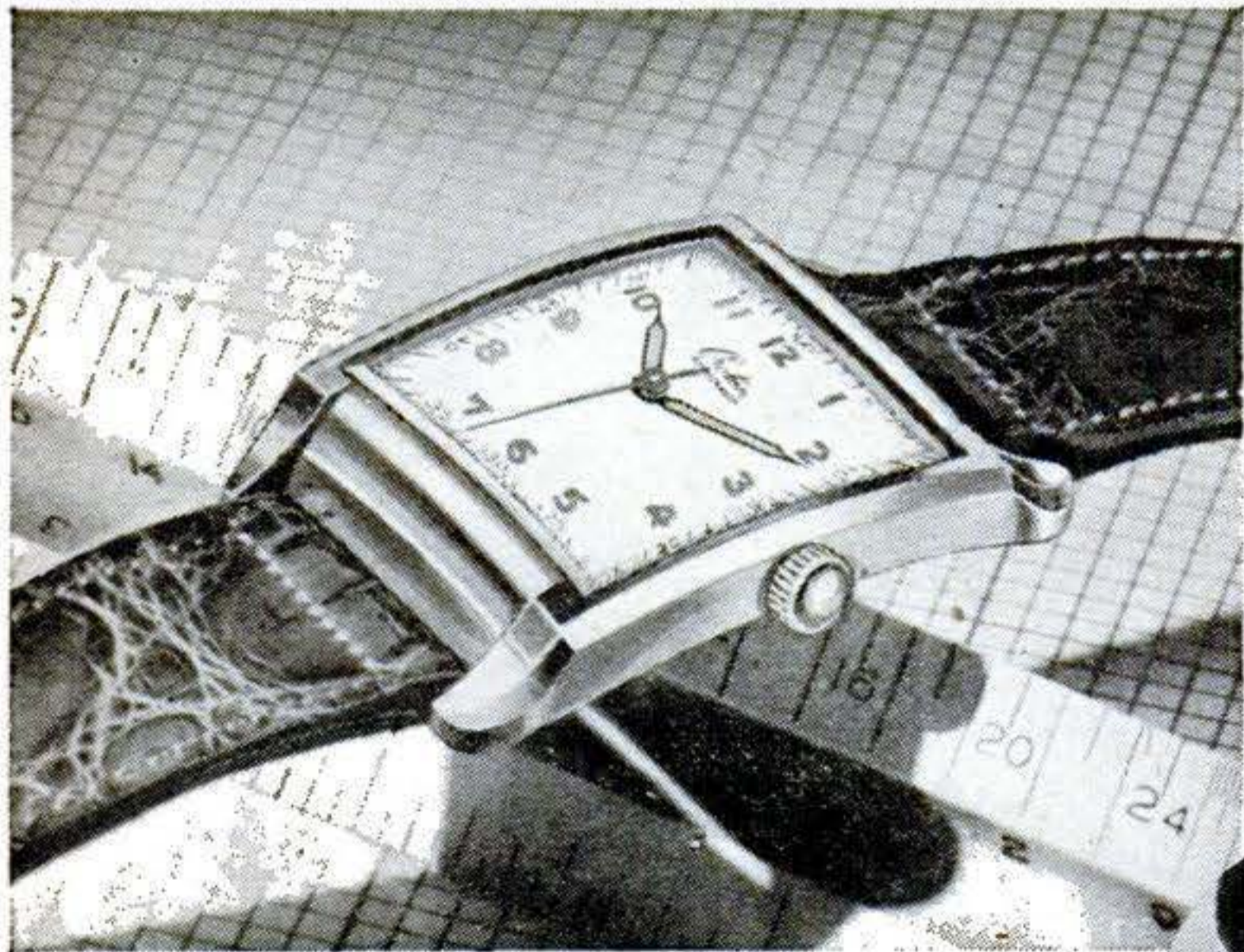

Douse it! Drench it!

You never have to remove your 17-jewel Croton Aquamatic when you swim or bathe. Before it goes to your jeweler, every watch is *certified waterproof* by the United States Testing Co., Inc. All you need do is make sure only your Croton jeweler opens, closes, and services your watch. Also: Dustproof, shock-resistant, radium dial easily read in the dark, the glass crystal can't shatter!

You'll thrill to it! Your astonishing Croton Aquamatic tells true time *because you never wind it!* It's actually more accurate — 13.5% more accurate* — than watches wound by hand. Here's why. The scientific self-winding mechanism is wholly automatic — winds your watch as you move your wrist. So the danger of over-winding or running down is out! And it's got that "massive" look every man wants, to look well-dressed from dawn through dark. Made only by Croton — famous since 1878.



Smart square case of stainless steel, curved to your wrist. Model D Sweep Second..\$59.50 Federal Tax Included

Croton
AQUAMATIC

*3 Aquamatics were tested against the average of 9 famous watches wound by hand, in a 30-day wearing test by a leading laboratory. Aquamatic proved 13.5% more accurate! Write for free booklet. Croton Watch Co., Inc., 48 West 48th Street, New York 19.

© 1947 Croton Watch Co., Inc., New York

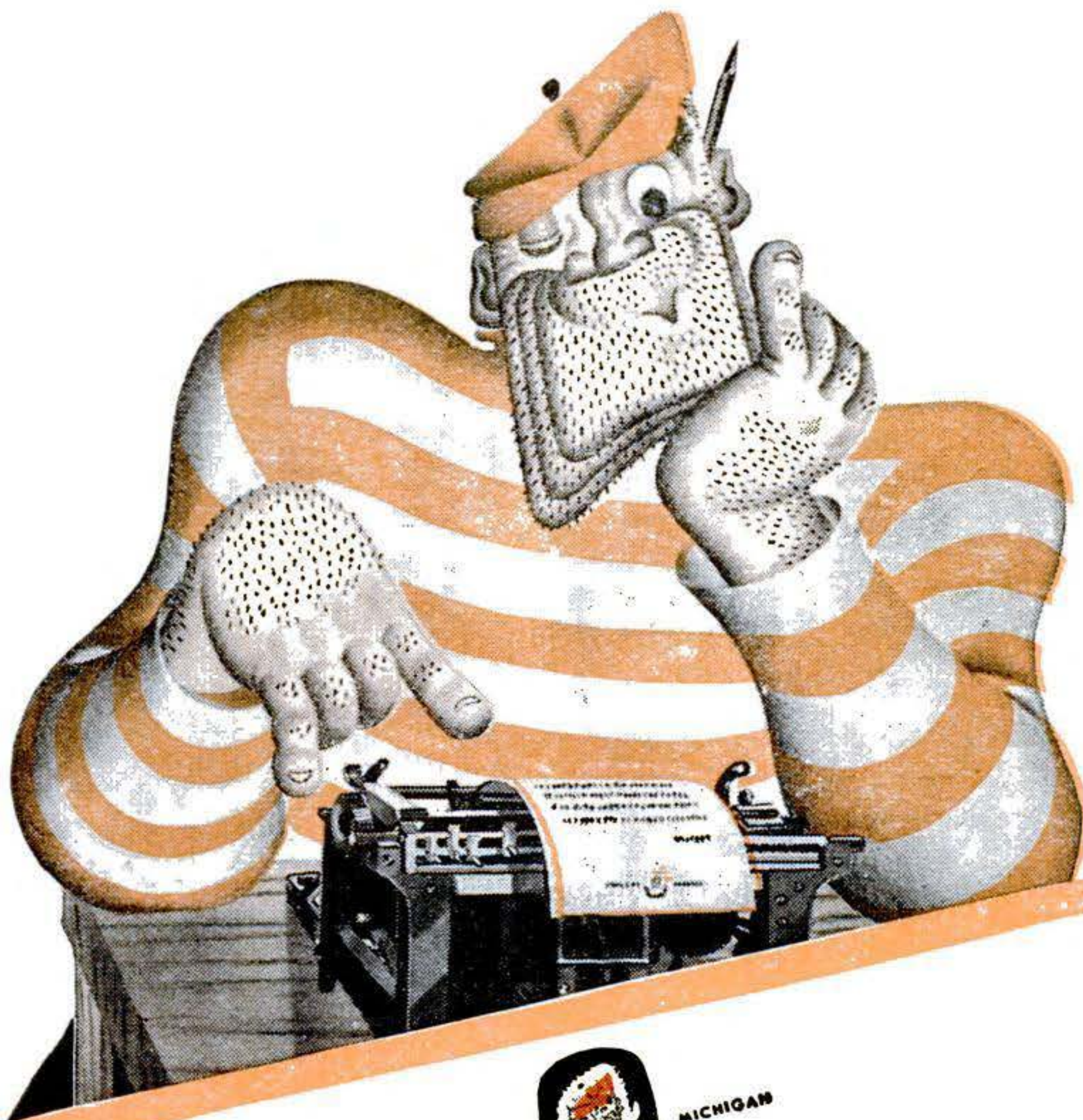

Dear Joe:

You're ~~right~~ right, oil-pumping is the first sign of worn-out piston rings. ~~This~~ And the only sensible thing to do is hurry to a good mechanic and get them replaced.

Naturally I'd recommend Hastings rings. Cause I KNOW from experience they DO stop ~~put~~ oil-pumping, engine restore/performance and check cylinder wear.

p.s. My boss says, "They'RE the best money you can spend on your car."

TOUGH BUT OH SO GENTLE



HASTINGS

TOUGH on Oil-pumping
GENTLE on Cylinder Walls

HASTINGS MANUFACTURING CO.
HASTINGS, MICHIGAN
Hastings Ltd., Toronto



Choose EVINRUDE

for tops in outboard performance — thrilling power for biggest boats and fastest runabout speeds



Choose EVINRUDE

for matchless 4-cylinder smoothness in 3 great models . . . "Speedifour", "Lightfour" and the famous "Zephyr"



Choose EVINRUDE

for the right power for every boat . . . with revolutionary new WEEDLESS DRIVE on two popular light models

Choose Evinrude . . . for the certainty of fine performance that means utmost satisfaction and enjoyment for years and years ahead.

See your Evinrude dealer—look for his name in your classified phone directory under "Outboard Motors". For free catalog of the complete Evinrude line write, EVINRUDE MOTORS, 5657 North 27th Street, Milwaukee 9, Wis.

EVINRUDE

FIRST IN OUTBOARDS

38th YEAR

In Canada: Evinrude Motors, Peterboro, Ontario



AMERICAN FLYER



Developed at the GILBERT HALL OF SCIENCE

SEE 'EM PUFF SMOKE!

HEAR 'EM "CHOO-CHOO"

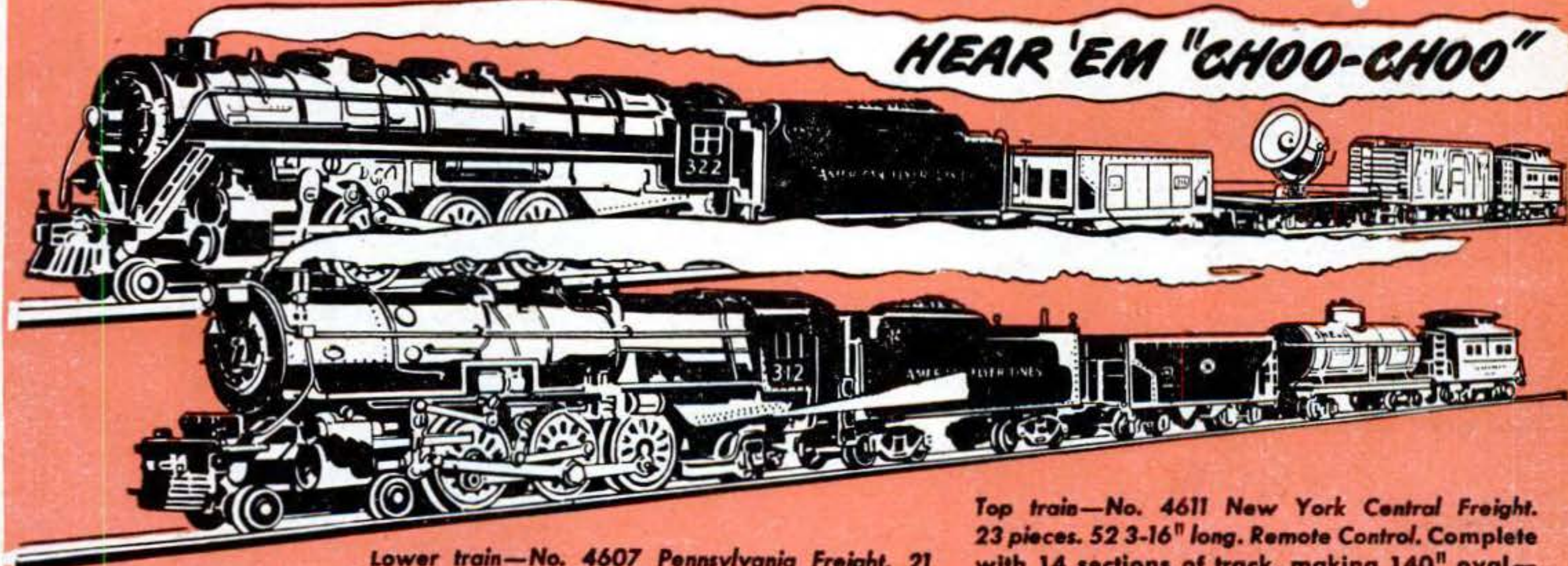

Lower train—No. 4607 Pennsylvania Freight. 21 pieces. 40 1/4" long. Remote Control. Complete with 14 sections of track, making 140" oval—

\$29.95

Top train—No. 4611 New York Central Freight. 23 pieces. 52 3-16" long. Remote Control. Complete with 14 sections of track, making 140" oval—

\$39.95

THE ONLY SCALE MODEL TRAINS WITH ALL THESE THRILLING FEATURES

- ★ Real smoke synchronized with train speed
- ★ "Choo-choo" sound effects synchronized with train speed
- ★ Realistic 2-rail track—no old-fashioned third rail
- ★ Trains and track built to uniform 3-16" scale
- ★ Spectacular new Electronic Propulsion locomotives
- ★ Billboard whistle—works with any train system

The new American Flyers bring you all the wonder and glory of railroading. They puff real smoke. The built-in "choo-choo" reproduces the choo-choo sounds of a real locomotive under full steam. Both smoke and "choo-choos" vary in intensity as you increase or decrease the speed of your train. Locomotive whistles, cars and track are all built to uni-

form 3-16" scale, so that your train looks like real—hugs the track like real. Cars have automatic couplers that couple anywhere. Uncouple by remote control. Die-cast locomotives have superpower worm drive that assures smooth, steady pull at all speeds from a crawl to 120 scale miles per hour. See and hear the sensational American Flyers at your nearest department or toy store.

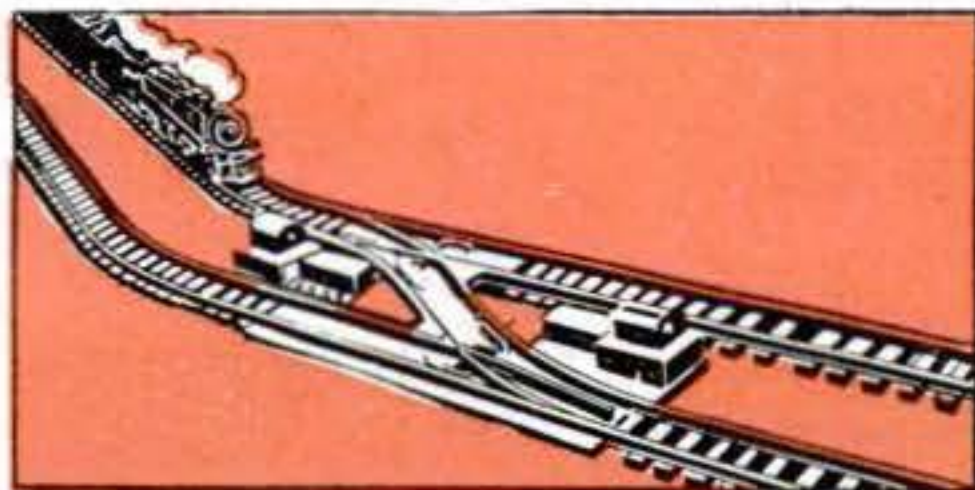

See . . . American Flyer's 2-rail track has no old-fashioned third rail in the middle. "T" design rail. Looks just like the track of a real steam railroad.

When in New York visit the famous Gilbert Hall of Science, Fifth Avenue at 25th Street. Admission free. The A. C. Gilbert Company, New Haven, Conn. Also makers of the famous Erector, Gilbert Chemistry Sets, Microscopes, Tool Chests and other Gilbert Scientific Toys.

HURRY! Send for this Colossal Illustrated Train Book

32 big pages with full color illustrations of all American Flyer trains and spectacular equipment. Advance news on sensational new Electronic Propulsion Locomotives, automatic coal loader, log loader, and other latest developments in scale model railroading. Mail coupon with 10¢.

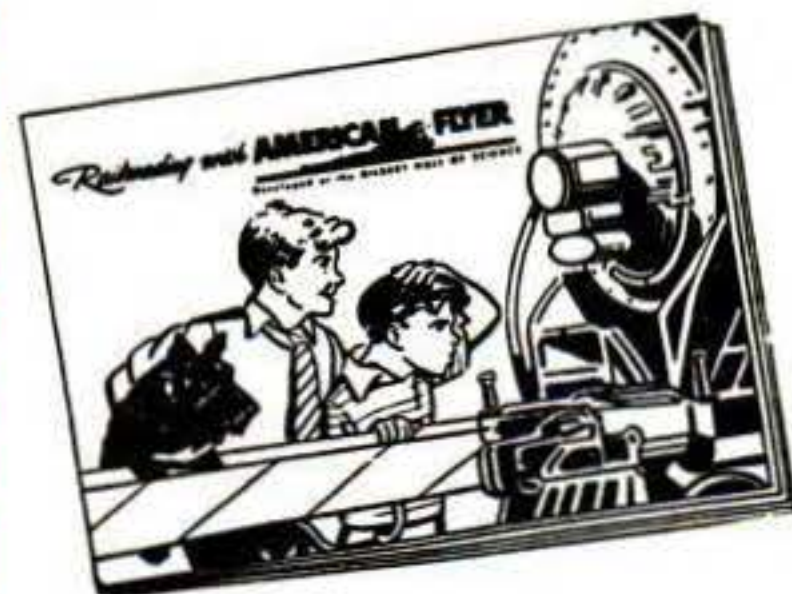

Gilbert Hall of Science
79 Erector Sq., New Haven, Conn.

I enclose 10¢. Please rush colossal illustrated train book.

Name

Street

City State

This offer good only in U.S.A.

Foremost!



**WITH MEN
WHO KNOW
FINE TOOLS**

To those who work with hand tools (artisans, farmers, mechanics), Plumb is their foremost choice.

One reason is that Plumb tools are perfectly balanced, not fatiguing or weighty. Another is that Plumb tools are made sturdier, they last longer. The specially selected materials, the special analysis steel in the one-piece head and the strong hickory handle, must pass many tests before the tool is finished.

But the foremost reason is that Plumb, for nearly 100 years, has taken extreme care in perfecting hand tools that do a better job faster. Fayette R. Plumb, Inc., Philadelphia 37, Pa.

*The red handle with the black head
— exclusively Plumb.*

**Quality Comes FIRST
PLUMB
is FIRST in Quality**

PLUMB

HAMMERS • HATCHETS • AXES • FILES

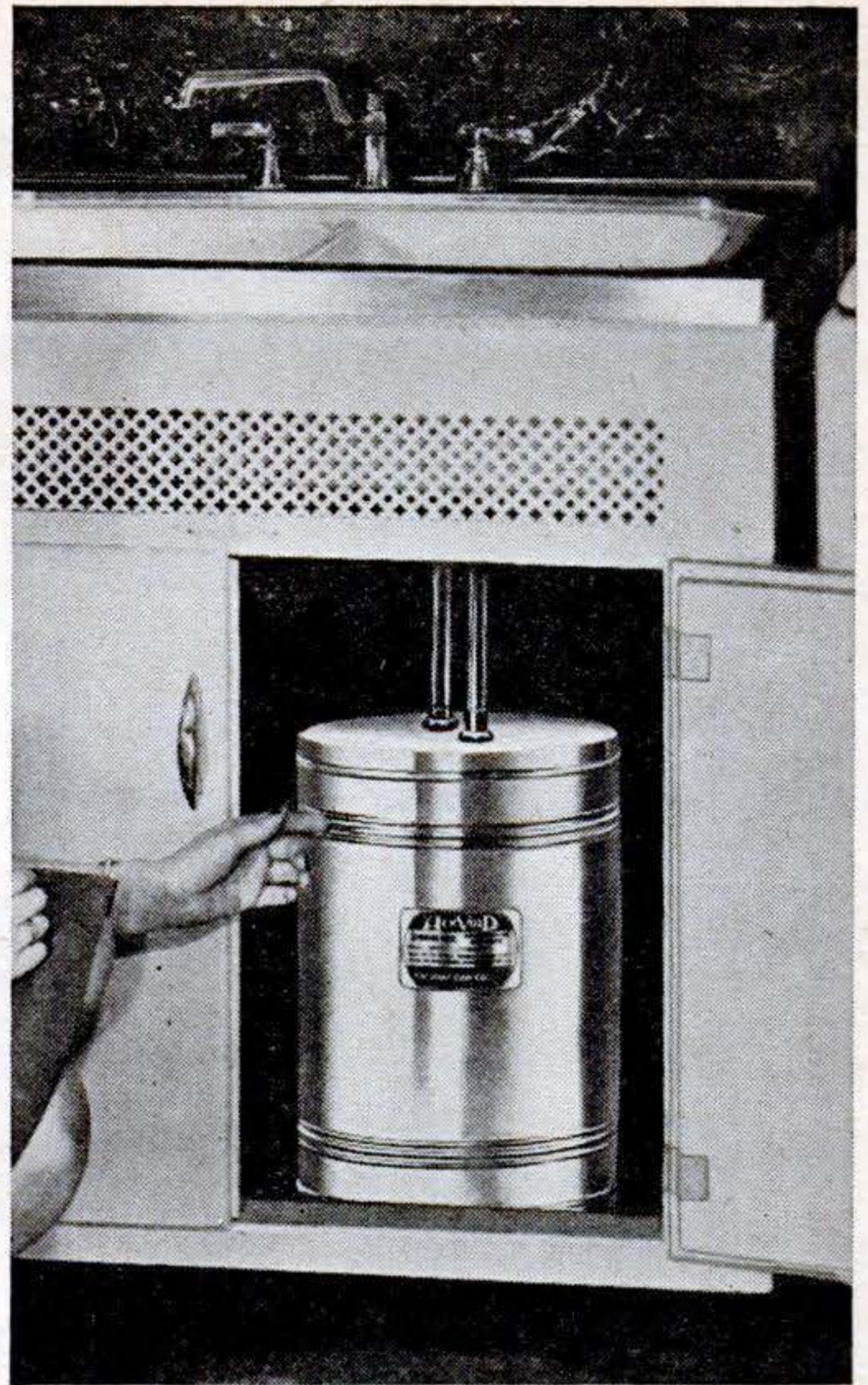

Compact Water Heater

HOT water for a small home or business establishment is provided by the compact electric heater shown above. The thermostat is set at 180° F., and, as hot water is drawn off, a twin-band element insures fast reheating of the remaining liquid. Made by the Vacuum Can Co., of Chicago, the heater has an inner tank and outer shell of stainless steel. Insulation that will not deteriorate surrounds the inner tank.



**Model Builders
Attention!**

	V	V-2	V-3
Hex	1/2"	3/8"	5/16"
Thread	3/8"-24	1/4"-32	1/4"-32
Thread Length	7/32	7/32	5/32
Weight, Grams	8	3 1/2	2 1/2

Actual Size V-Plug

Champion Spark Plugs for model gas engines give the same dependable performance as regular Champions. Champion Ceramic insulation—Sillment sealed. Alloy needlepoint electrodes for easy starting. One piece construction.

CHAMPION

SPARK PLUG COMPANY • TOLEDO 1, OHIO

Dependable

CHAMPION

AMERICA'S FAVORITE SPARK PLUG



A new set of dependable Champion Spark Plugs is just the thing to make your car start like the proverbial scared rabbit. Quick starts, faster warm-up, and all 'round better engine performance result in substantial gas savings. In addition, they'll reduce excessive drain on the battery, and minimize the danger of crankcase dilution. Now is the time to have your Champion dealer check your spark plugs. Be sure to get dependable Champions if you need new ones. Champion Spark Plug Company, Toledo 1, Ohio.

FOLLOW THE EXPERTS

**DEMAND NEW DEPENDABLE
CHAMPIONS FOR YOUR CAR**

Listen to the CHAMPION ROLL CALL . . . Harry Wismer's fast sportscast every Friday night, over the ABC network

Wow! Now
CHEMCRAFT
 has **ATOMIC ENERGY!**



Safe! Exciting! Real!
ATOMIC ENERGY
 Exclusive with **CHEMCRAFT!**

Safe, exciting Atomic Energy Experiments make Chemcraft more fun than ever before. And listen, fellows . . . Chemcraft's Atomic Energy feature is the **REAL THING!** You actually conduct your own experiments with the awesome, mysterious and breath-taking force of Atomic Energy. Yet *all* materials, experiments and apparatus are absolutely safe . . . even the Uranium Ore released to Chemcraft by the U. S. Atomic Energy Commission. Send today for new **FREE** descriptive booklet. Mail coupon below. *Insist on . . .*

CHEMCRAFT

AMERICA'S LEADING CHEMISTRY OUTFITS

Atomic Energy comes to you as an **EXTRA SPECIAL ADDITION** to the many other exciting, exclusive features which have made the name **CHEMCRAFT** famous among millions of boy and girl chemists.

Experiments, Instruction Manuals, Chemical Magic, Bryan Chemical Illustrators, Glass Blowing, Chemcraft Chemistry Charts, "The Story of Chemistry" booklet and other popular, exclusive features are included in the larger Chemcraft outfits as usual. No other chemistry outfits give you such a broad assortment of high-grade chemicals, in such large quantities. Ask for it by name.

CHEMCRAFT—SOLD BY LEADING STORES EVERYWHERE
 . . . **No Poisons, No Explosives, No Unpleasant Chemicals**

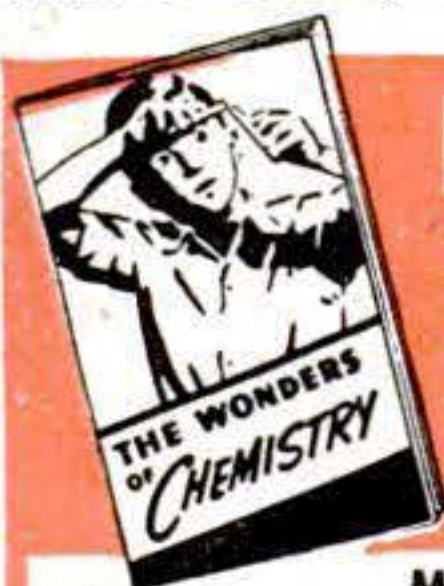

BOYS-IT'S FREE!

Exciting book tells all about "The Wonders of Chemistry" and Atomic Energy. Also describes many fascinating home experiments, tells of many amazing things made possible by chemistry.

Mail coupon for your **FREE** copy today!

THE PORTER CHEMICAL COMPANY
 74 Prospect Avenue Hagerstown, Md.

Mail me **FREE**, without obligation, your new booklet, "The Wonders of Chemistry". (Print plainly)

Name.....Age.....

Address.....

City.....Zone.....State.....

SHOVELS SNOW, SAWS WOOD PLOWS and CULTIVATES



These rugged walking and riding tractors pay their way the year 'round. Plows, discs, harrows, hauls, operates lawn mower, cutter bar, spray, bulldozes, plows snow, runs wood saw and other belt machinery.

Ideal for small farms, orchards, truck gardens, poultry farms, golf courses and estates.

Easy to change attachments with improved Jiffy Hitch. Patented tool control allows quick adjustment for wide hills or crooked rows. Sturdy, extra-strength construction means low up-keep cost. Operates for only a few cents an hour.



LOW FACTORY PRICES

Buy direct and save. Mass production holds prices down—quality up. Anyone who has a garden can afford a "Peppy Pal". Write for **FREE** folders and price list.

SHAW
MFG. CO.

5712 FRONT ST., GALESBURG, KAN.
 668 PS NORTH 4th ST., COLUMBUS, O.

PRESSURE QUEEN

FOUR CYLINDER
 PORTABLE AIR COMPRESSOR
 SPRAY PAINTING OUTFIT

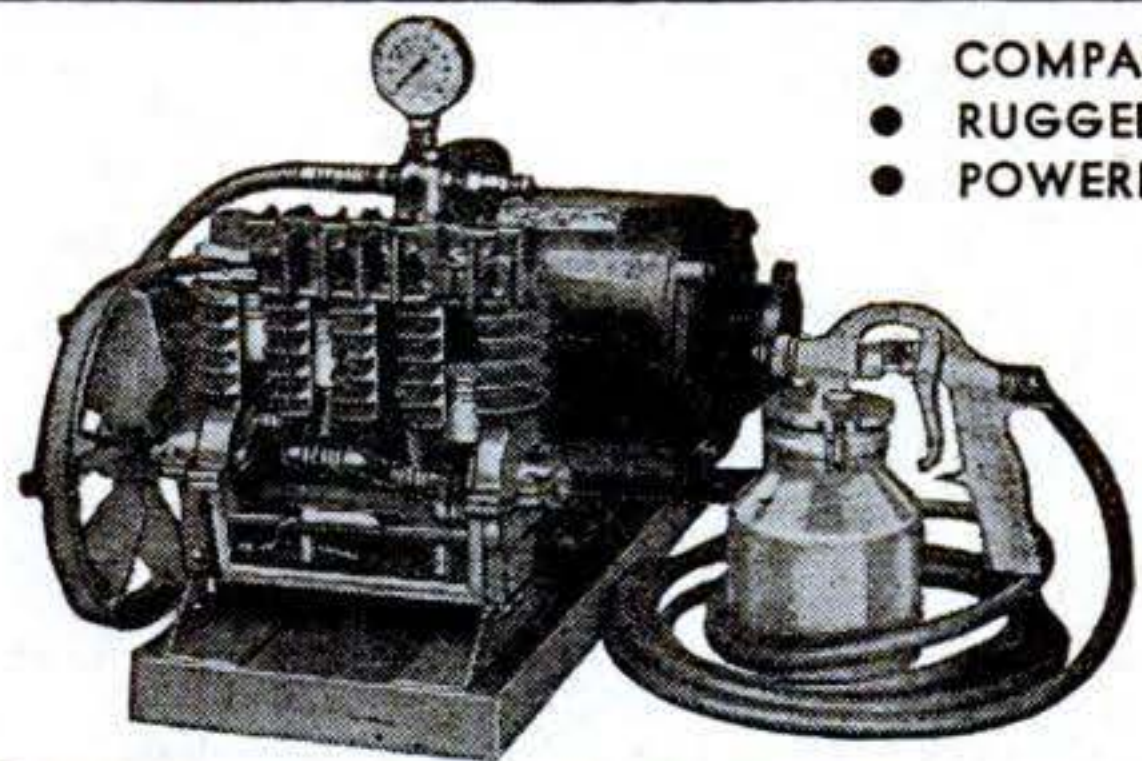

- COMPACT
- RUGGED
- POWERFUL

Immediate delivery on compressor with motor

AMAZINGLY LOW PRICED FOR THE ONLY
 FOUR CYLINDER UNIT ON THE MARKET

The ideal air supply for home and farm workshop, machine shop, garage and contracting painter; for product finishing, inflating tires, painting automobiles, trucks, machinery, etc.

This 4 cylinder compressor has drop forged crankshaft, stainless steel, heat treated valves; bronze bearings and positive forced feed lubrication. Maximum pressure 50-60 lbs., free from pulsation. Standard equipment includes the compressor mounted on steel base with carrying handle, belt, compressor pulley, air chamber, air gauge, 15-ft. hose, spray gun; 1/2 or 3/4 h.p. motor or gas engine. Immediate delivery.

If your dealer does not sell Pressure Queen write direct
THE CAMPBELL-HAUSFELD CO.
 151 RAILROAD AVE. HARRISON, OHIO

**Christmas
Suggestion . . .**

for the man who owns, or plans
to own a workshop, no gift could
bring more pleasure.

Logan

A NAME TO REMEMBER WHEN YOU
THINK OF BETTER LATHES AND SHAPERS

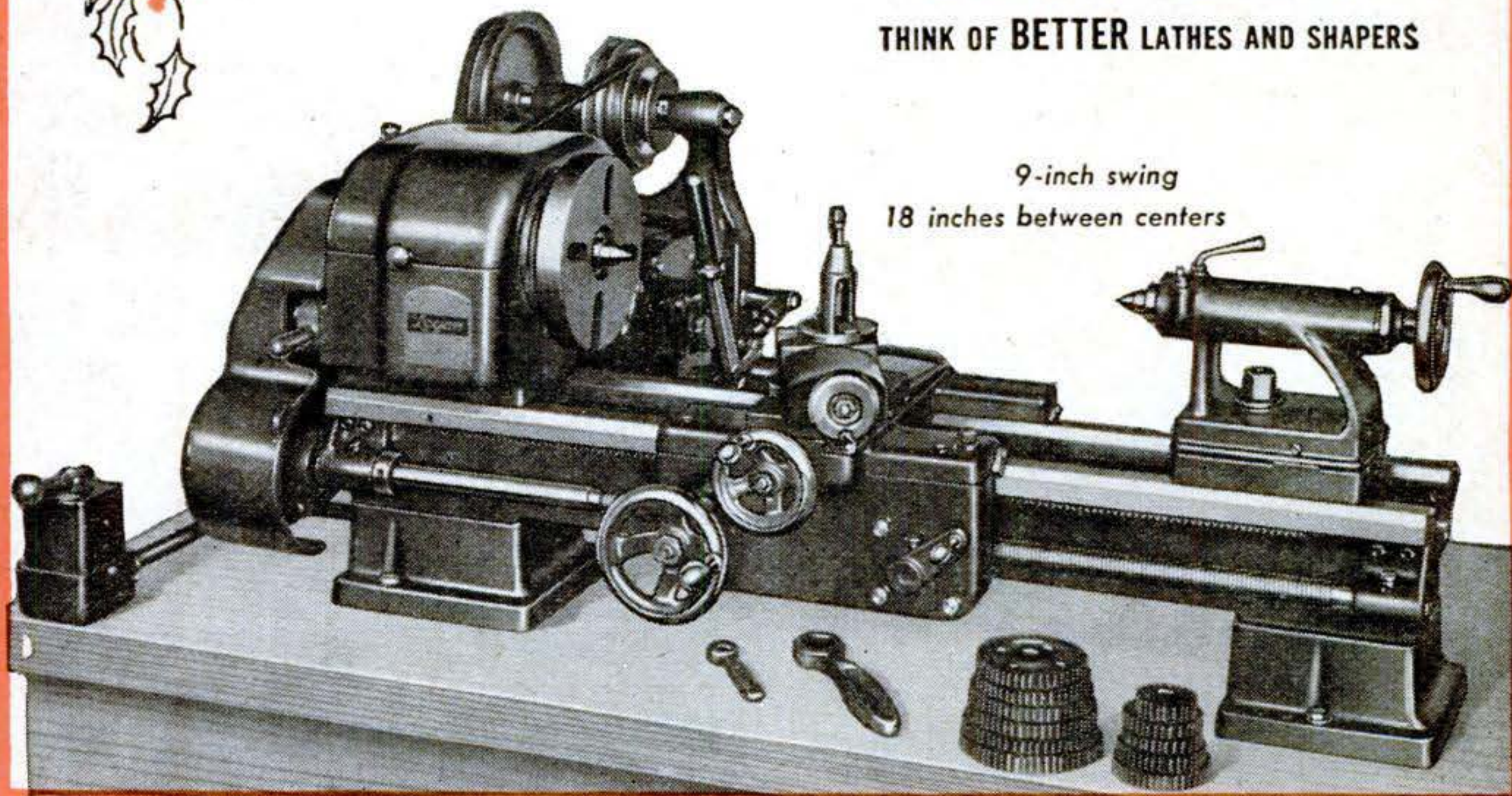

9-inch swing
18 inches between centers

**A LATHE TO
DEPEND ON**

Logan Ruggedness
and Lasting Accuracy
. . . at \$159⁵⁰

This compact Logan 9-inch Lathe handles manufacturing operations with the same speeds and precision that make the larger Logan Lathes outstanding in industry. For general machine shop and tool room work, farm equipment maintenance, and home workshop projects, it is equally effective. The ball bearing spindle mounting, the self-lubricating bronze bearings at other vital points, and the V and flat bed ways precision ground to within .0005" of parallelism are typical of Logan advanced design. Rugged, rigid construction makes it steady on heavy cuts. See this outstanding 9-inch lathe at your Logan Lathe dealer's or write for information.

DISTRICT OFFICES: WOOLWORTH BLDG. 550 W. WASHINGTON BLVD. 1672 MISSION STREET 700 COMMERCE ST.
NEW YORK 7, N. Y. CHICAGO 6, ILLINOIS SAN FRANCISCO, CALIF. DALLAS 2, TEXAS
CORTLAND 7-8024 CENTRAL 1246 UNDERHILL 6682 CENTRAL 4075

LOGAN ENGINEERING CO., Dept. C-12, CHICAGO 30, ILL.

DECEMBER 1947 239

Speed Sweep

THE BRUSH WITH THE STEEL BACK



*Sweeps cleaner, faster -
Out lasts ordinary brushes 3 to 1!*

Mail Coupon Today

Milwaukee Dustless Brush Co.
530 N. 22nd St., Milwaukee 3, Wis.

Please send me complete information about Speed Sweep brushes.

Name _____

Street Address _____

City, State _____

Here's the GIFT that gets
BETTER PICTURES

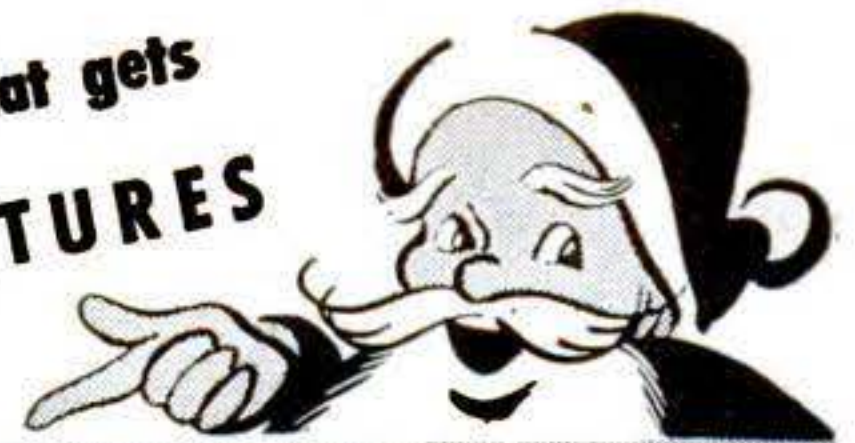

THE FAMOUS



Exposure Meter

"the choice of experts"



Takes the "guess" out of color shots, movies, stills. Makes sure of correct exposure for perfect pictures. Easy to use. Accurate. Sturdy. Dependable. An all-year gift!

NEW Deluxe Type PR-1

Superb gift for expert or beginner. Vest-pocket size. Remembers the light it sees . . . pointer lock can't forget! Many other advantages. Ask your photo dealer. Or write for information. General Electric, Schenectady 5, N. Y.

\$32.50* Federal tax included

*In states where Fair Trade Contracts are in effect.



GENERAL  ELECTRIC

806-9

USE YOUR BENCH SAW

FOR JOINTING & CUTTING MOULDINGS

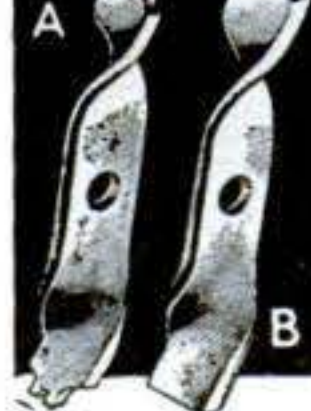

With our six inch tool steel cutters make mouldings, casings, drop-leaf tables, grooves beading and jointing. Moulding cutters, A 1 in. wide \$1.50, 1 1/2 in. \$2.00. Jointing cutters, B 1 in. \$1.50, 1 1/2 in. \$2.00. E 1 in. for drop-leaf tables, \$1.50, E 1 1/2 in. Makes 3/4 in. cove & Quarter. \$2.00. Postpaid. Guaranteed. State size hole. List & Folder free.

JOHN A. SANDSTROM
Rt. 1-P. Clearwater, Fla.



SEALED POWER PISTON RINGS

save oil, save gas, restore original power

Send postal for free booklet on oil-saving.

SEALED POWER CORP., DEPT. H6, MUSKEGON, MICH.



CARBIDE SCRIBER

NON-MAGNETIC

Tungsten Carbide — carefully ground on diamond laps, brazed into stainless steel 6" handle for marking steel and other metals — for etching, marking, cutting glass. In plastic case with pocket clip.



PRICK PUNCH

Tungsten carbide tip, silver brazed into 3 1/2" heat treated steel body.



LUCAS-MILHAUPT ENGINEERING CO.

5051 SOUTH LAKE DRIVE • CUDAHY, WISCONSIN



When you want to fix things fast... remember Weldwood Glue. It's quick to mix... easy to use... tremendously strong... stain-free... rot-proof... and permanent. At hardware stores, lumber yards, chain stores.



WELDWOOD PLASTIC RESIN WATERPROOF GLUE

United States Plywood Corporation, New York 18, N. Y.

Completely New and COMPLETE

Federal's Low Price INCLUDES A Highly Corrected Enlarging Lens

When you examine the price tags of the new Federal Enlargers remember that the price on the tag is for a complete enlarger... LENS AND TAX INCLUDED.

For Federal's low prices are not arrived at by stripping off important enlarger parts and listing them as separate items in order to give the impression of low price.

Federal's prices are low... the result of years of specialized experience in designing and building "America's Fastest Selling Enlargers"... undeniably America's greatest enlarger values.

MODEL 312. For miniature to 2 1/4" x 3 1/4" negatives. Fedar: 3 1/2" F:6.3 Anastigmat with Iris Diaphragm.

Complete with lens **\$53⁰⁰**
Tax Included

Model 315 (as illustrated) \$89.50



FEDERAL MANUFACTURING & ENGINEERING CORP
Makers of Photographic & Electronic Devices
213 STEUBEN STREET • BROOKLYN 5, N. Y.

See These New JACOBS CHUCKS for the HOME SHOP



HEX-KEY Model for drill presses, lathes and motor shafts

- ★ 4 models, capacities up to 1/2"
- ★ straight hole design to fit 1/2" or 5/8" shafts
- ★ fits plain end drill press spindles, motor shafts, and other powered shafts
- ★ special arbors for Morse Taper spindles

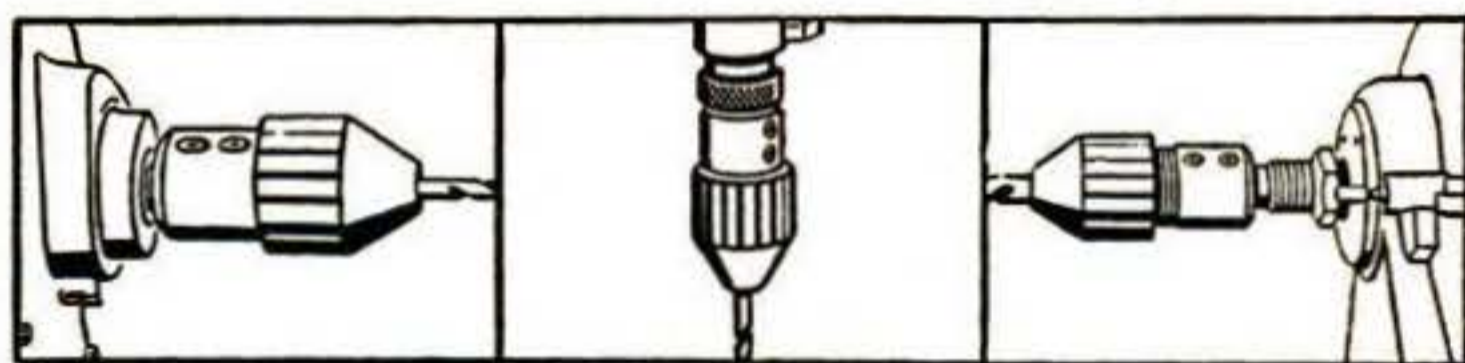

Easily fitted to the shaft, makes a motor into a power tool of many uses.

Holds drills, grinding wheels, sanding drums and other accessories.

For chucking jobs on small work, chuck can be held in lathe spindles.

HAND-TITE Model for hand drills, flexible shafts, polishing heads.

- ★ 3 sizes for tools with spindles up to 1/2" dia.
- ★ 2 diameters to fit 3/8" or 1/2" spindles.

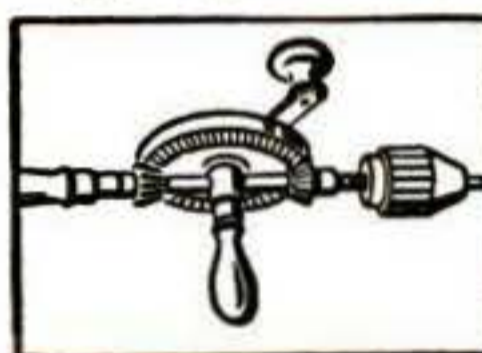

Greater gripping power and dead-center accuracy for drills.

On a bench grinder, this chuck gives a horizontal drilling set-up.

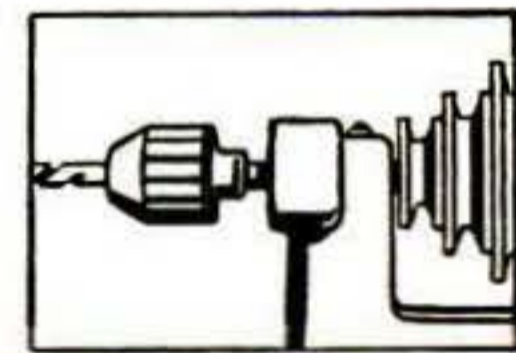

RUBBER-FLEX Jaw Assembly

One-piece construction... hardened alloy steel jaws bonded together by oil-proof synthetic rubber... no loose jaws or springs. Tremendous gripping power. Accuracy not previously possible in popular priced chuck.

See these 2 new Jacobs Chucks at your hardware dealer's.

THE JACOBS MANUFACTURING COMPANY,
Hartford 2, Conn.

Please send your new illustrated folder on the Jacobs Rubber-Flex Hex-Key and Hand-Tite Chucks.

Name.....

Street.....

City..... State.....



THE NAME FOR SOLID-CENTER
AUGER BITS OF HIGHEST QUALITY

Greenlee 22
SOLID-CENTER AUGER BITS

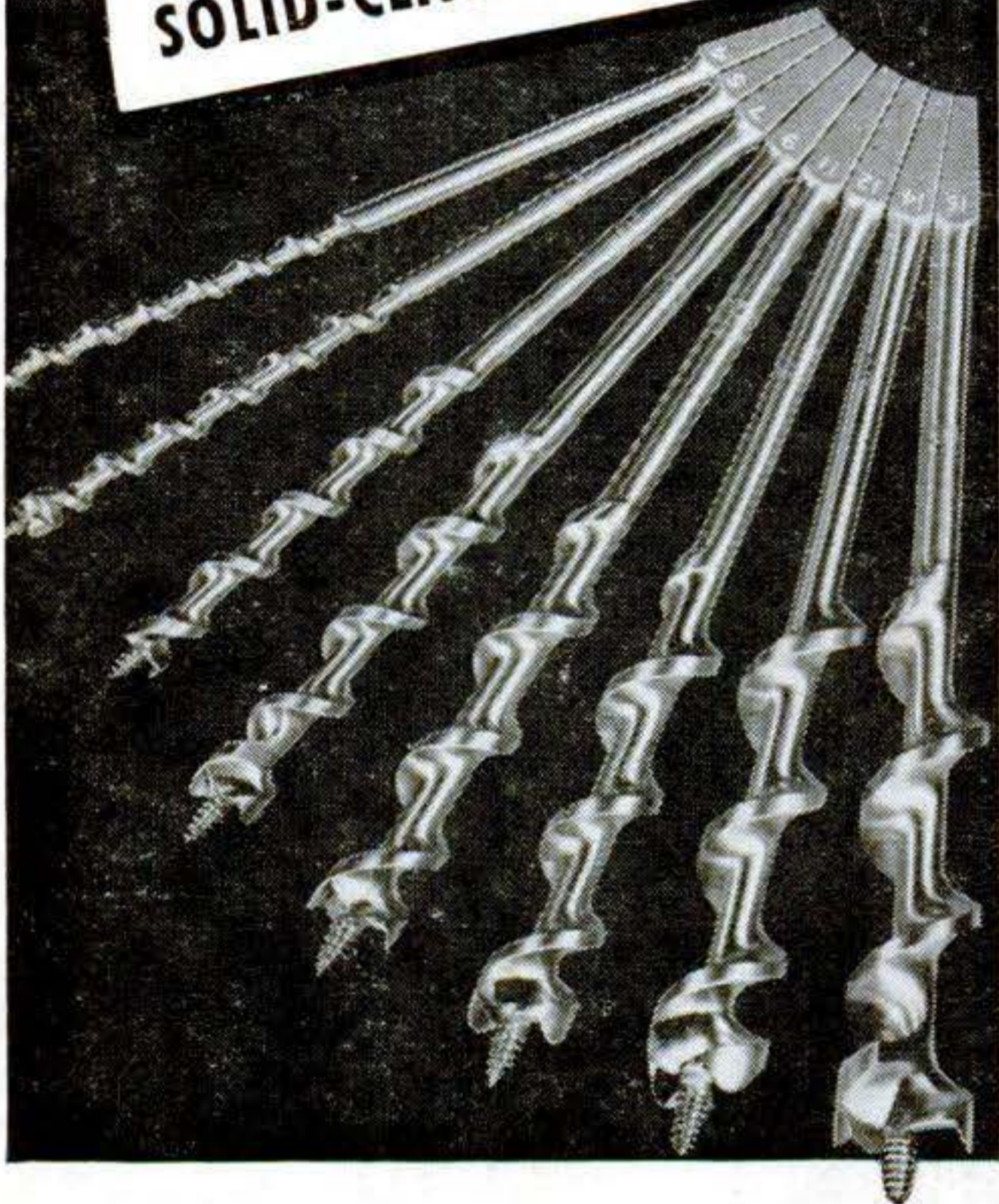

GREENLEE 22 is a name it will pay you well to remember whenever you buy Auger Bits. For it assures you sharp cutting edges, accurate sizing, bright, high finish, and that smooth, easy action so necessary in fine craftsmanship. You can be certain, too, that every **GREENLEE 22** Solid-Center Auger Bit is "factory sharp" when it reaches you. For each is "Plastic-Sealed" with a special protective coating to keep it in perfect condition for the exacting work you will surely want to do with it. To buy top quality, buy **GREENLEE**.



**SPECIAL OFFER . . .
ONLY 10c FOR HANDY
WOODWORKING CALCULATOR**

Quick solutions to countless woodworking problems. Converts linear to board feet, gives slope per foot, nail and bit sizes, etc. 6" diameter. Send coin to Greenlee Tool Co., 2132 Columbia Avenue, Rockford, Illinois.

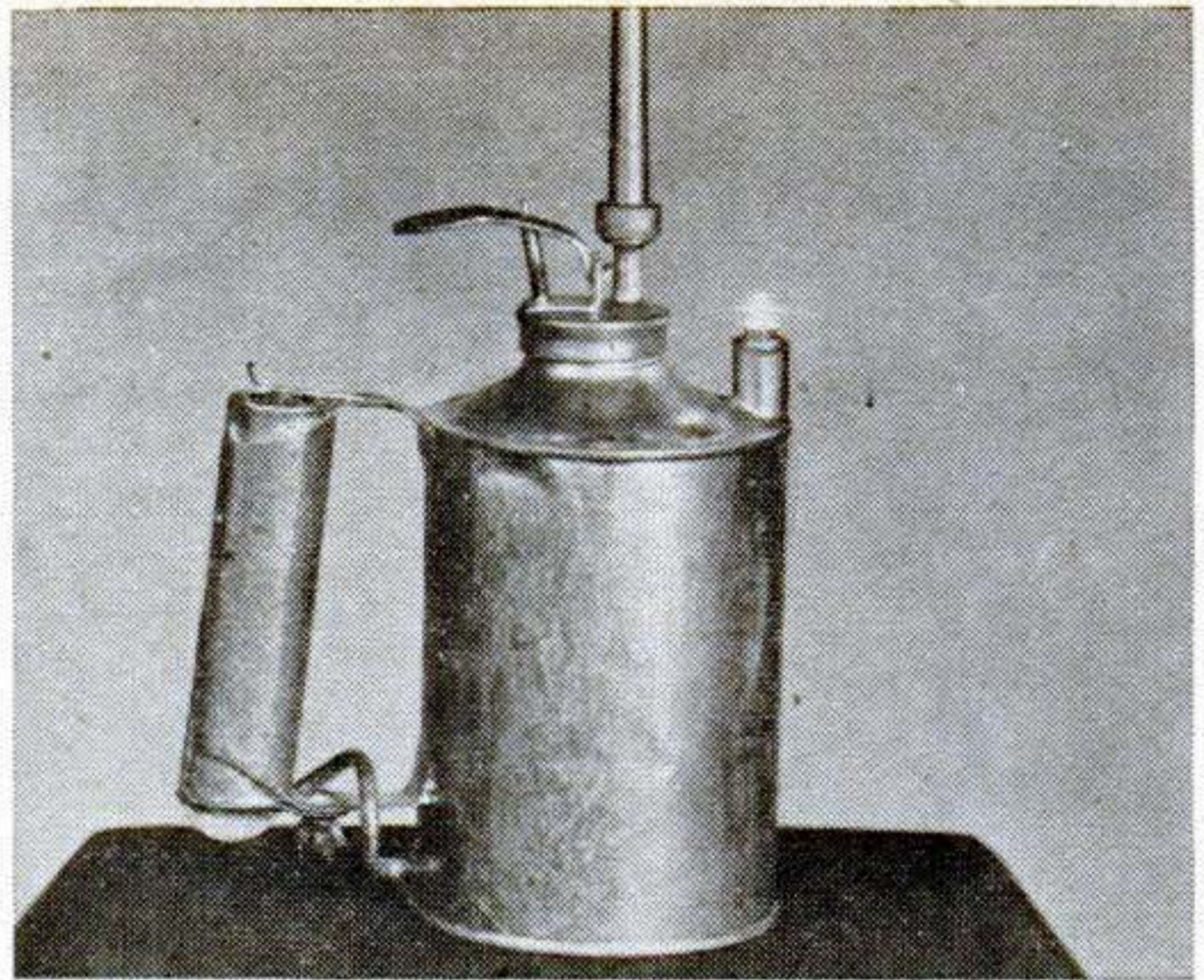

Lights as It Oils

EVEN in the darkest crannies you can always see what you're oiling with this can. A flashlight is built into the top and focused toward the spout. The battery is set in the handle. Rogers Realty Co., of Oklahoma City, developer of the can, describes the one above as handmade; its appearance will be changed before it is marketed.

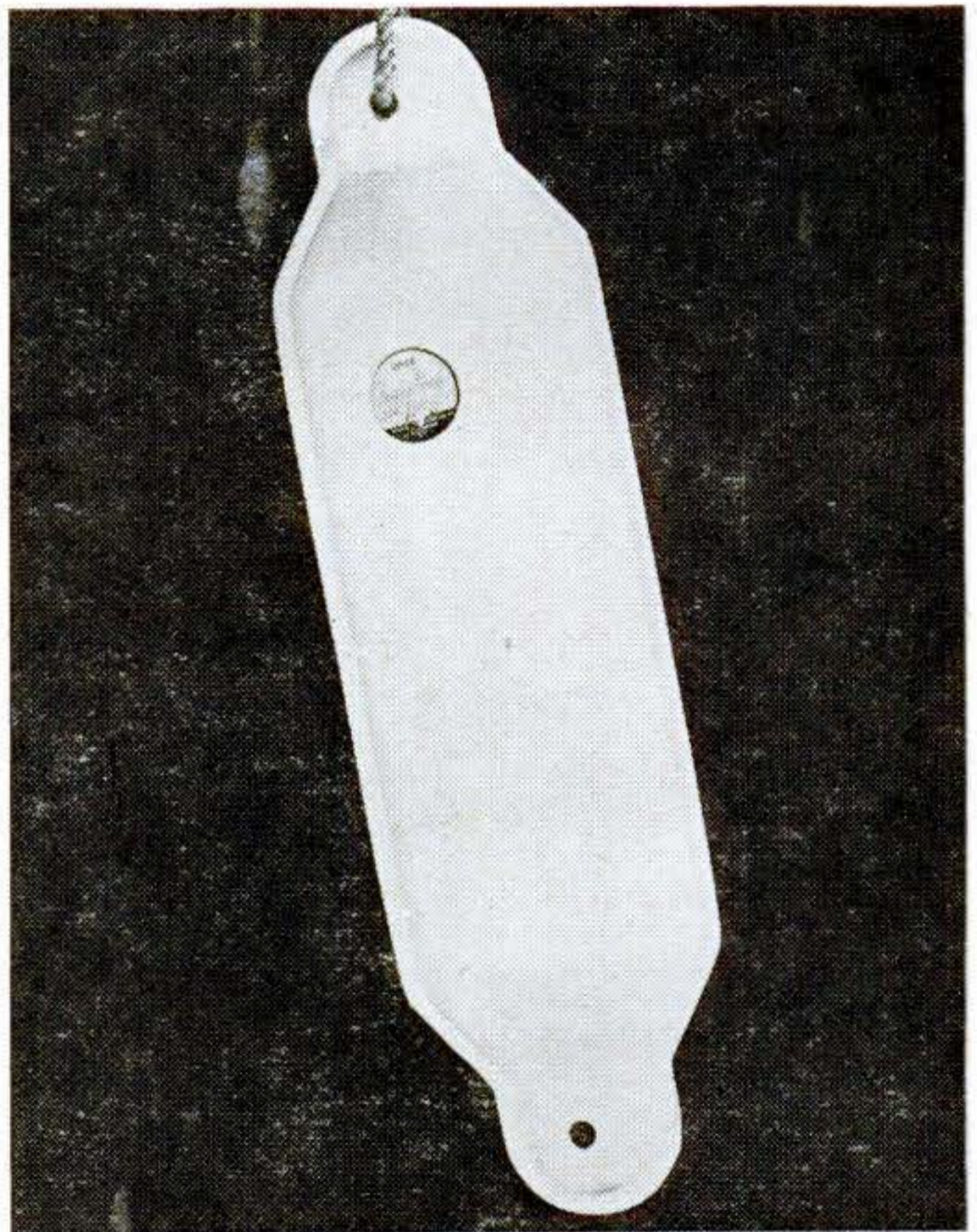

Fender Floats as Buoy

THIS boat fender doubles as a buoy. Molded of durable synthetic rubber, the Fender Float's five-pound internal air pressure makes it buoyant as well as a cushion between a boat and a wharf.



Price: \$42.50
 Fed. Excise Tax: 8.50
 Carrying Case: 7.08
TOTAL: \$58.08

**ARGUS
 MODEL 21**

Only Argus 21 has "Markfinder" sight. Center cross-mark speeds aiming. Guideline border improves framing. F3.5 Anastigmat lens coated, color-corrected. Double-exposure guard. Synchronized flash. Speeds 1/10 to 1/200. Takes 35mm. film. Flash unit extra. \$8.75

ARGUS MINCA

F9.7 precision-ground double lens—the fastest lens of any camera in its class. Three easy-to-use settings for all outdoor pictures. Fast, accurate shutter: 1/80 of a second helps eliminate blurry pictures. Takes 828 film.



Price: \$8.53
 Fed. Excise Tax: 1.42
TOTAL: \$9.95



Price: \$52.40
 Fed. Excise Tax: 8.50
 Carrying Case: 8.73
TOTAL: \$69.63

**TWIN-LENS
 ARGOFLEX***

Avoids tilting, cropping, prevents faulty focus. You see your picture before you take it. F4.5 Anastigmat, coated, color-corrected lens. Speeds, 1/10 to 1/200. 12 exposures (2 1/4 x 2 1/4) on 620 roll. Carrying case.

*REG. U.S. PAT. OFF.

ARGUS PROJECTOR

Uniform illumination to edges. Designed to keep slides safe from heat. Takes slides right side up. Projects your favorite 35 mm or Bantam slides with unusual clarity. Film strip adapter available for showing unmounted 35 mm or Bantam film strips, \$3.95 extra.

Price: \$31.85
 (Complete with carrying case)



This Christmas

**GIVE AN
 ARGUS**

*...the kind of gift
 you'd like to get!*

What is there about an Argus that makes it such a wanted gift? Simply this: Every Argus product is rigidly engineered to meet the exacting requirements of the critical camera fan. That's why, when you give an Argus, you know you give your best. So — see your Argus dealer today. He'll give you sound advice in helping you select the Argus gift you want.

ARGUS, INCORPORATED • ANN ARBOR, MICH.

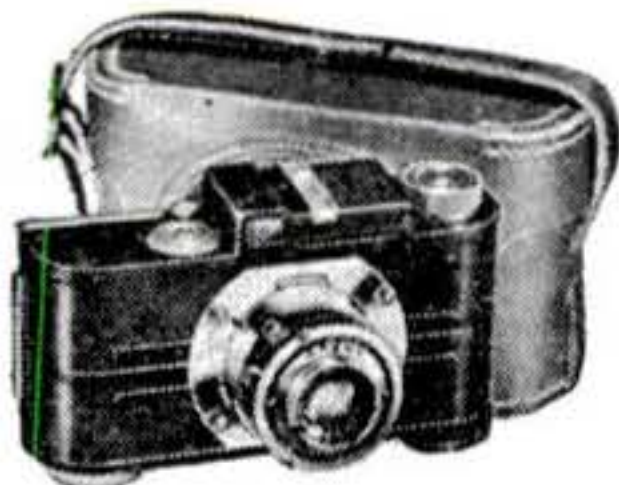

Price: \$27.50
 Fed. Excise Tax: 4.58
 Carrying Case: 5.50
TOTAL: \$37.58

ARGUS MODEL A-2

F4.5 Anastigmat, coated, color-corrected lens. Automatic shutter with speeds from 1/25 to 1/150. Built-in extinction-type exposure meter. Optical viewfinder. Takes 35 mm film.

ARGUS C-3

Coated, color-corrected F3.5 Anastigmat lens. Synchronized flash attachment. Accurate, lens-coupled, split-field range finder. Shutter speeds, 1/10 to 1/300. Takes all standard 35 mm film.



Price: \$56.75
 Fed. Excise Tax: 8.50
 Carrying Case: 9.46
TOTAL: \$74.71

FINE CAMERAS, PHOTOGRAPHIC PRODUCTS AND PRECISION OPTICAL INSTRUMENTS

NEW HOME MOVIES YOU WANT TO OWN!

PICTOREELS

for 8 mm.—16 mm. sound-silent home projectors

BELLES OF BALI

Picture pageant of life in lovely, languorous Bali—heavenly island you've dreamed about!



PUPS' CHRISTMAS

What a crazy Christmas morn when pups get tangled in the presents. See them battle Tuffy—the terrific toy tank!



SNOW FUN

A dozen ways to have fun on ice or snow. Thrills and spills in your favorite winter sports!

FREE YOUR DE LUXE NEW PICTUREEL

catalog of sound and silent home movies is ready. Send for it!

Please send the home-movies checked below.
I enclose remittance Send C O D

2.	COMPLETE			STREAMLINER	
	16 snd	16 sil.	8mm	16mm	8mm
BELLES OF BALI	\$17.50	\$8.75	\$5.50	\$2.75	\$1.75
PUPS' CHRISTMAS					
SNOW FUN					

Name _____

Address _____

City _____ State _____

B-12

PICTORIAL FILMS, Inc.

625 MADISON AVE., NEW YORK 22, N. Y.



Oil Gauges Air Speed

CASTOR oil has added another to its many uses in this Westinghouse gauge to study air velocities in an electronic air cleaner. The center tube holds the castor oil, while the two bottles on either side contain salt water. Air entering the right-hand bottle forces a salt-water bubble up into the oil. By varying the pressure until the bubble lines up with a hairline marker on the magnifying scope, the velocity of the entering air can be accurately determined.

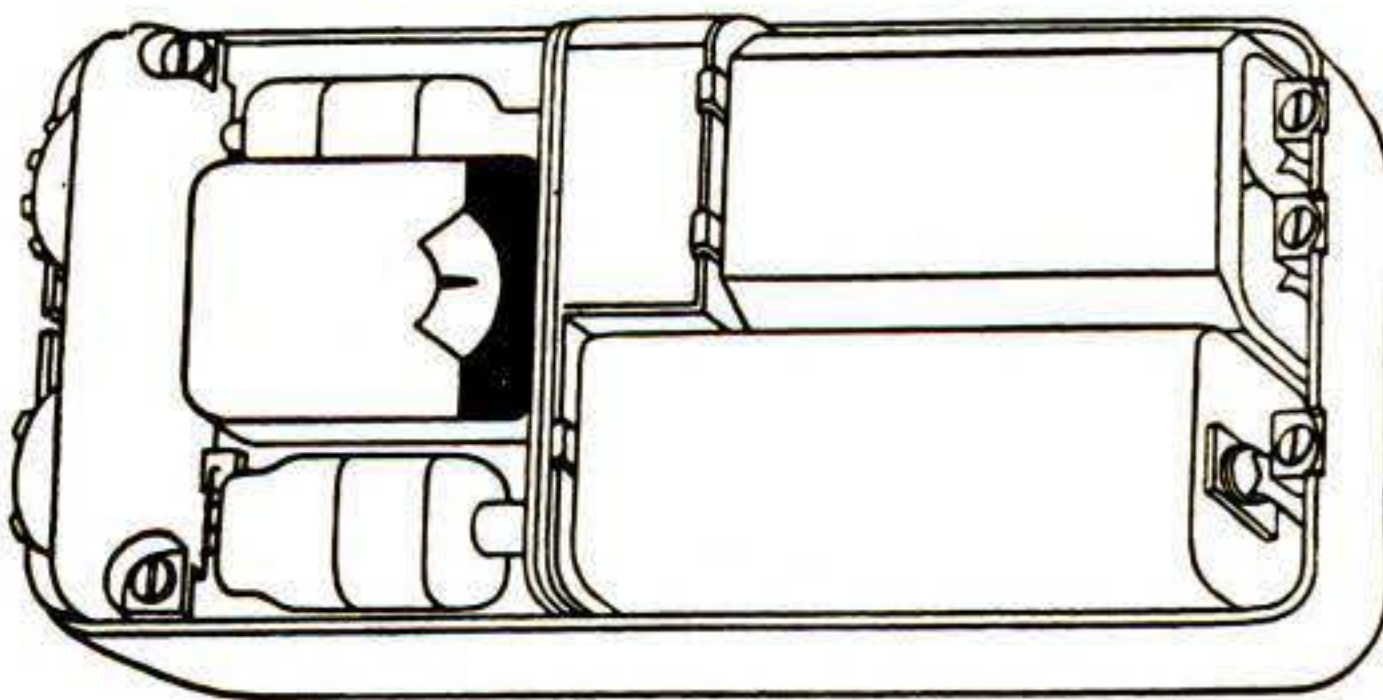

Ear Aid Tests Own Life

To PREVENT battery failure, the latest Otarion hearing aid, diagramed above, boasts its own built-in battery tester. A Metrodyne voltmeter, it tests both A and B batteries and indicates their probable hours of service. It also helps localize operational troubles by eliminating the batteries as a possible cause. The entire instrument, including tester, weighs eight ounces.

HERE'S WHY NEW AUTO-LITE "Sta-ful" BATTERY...

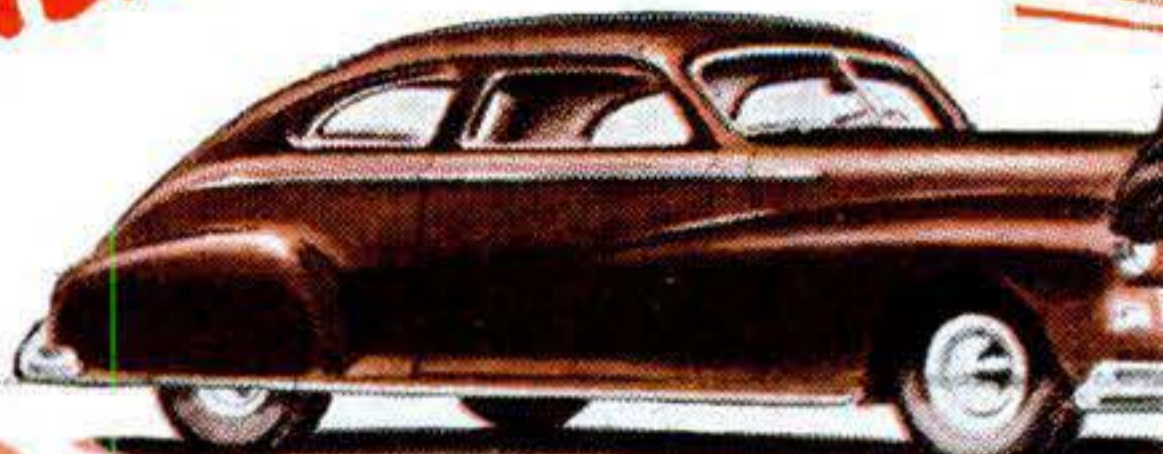

needs water only

3

times a year!

BOTH BATTERIES FULL

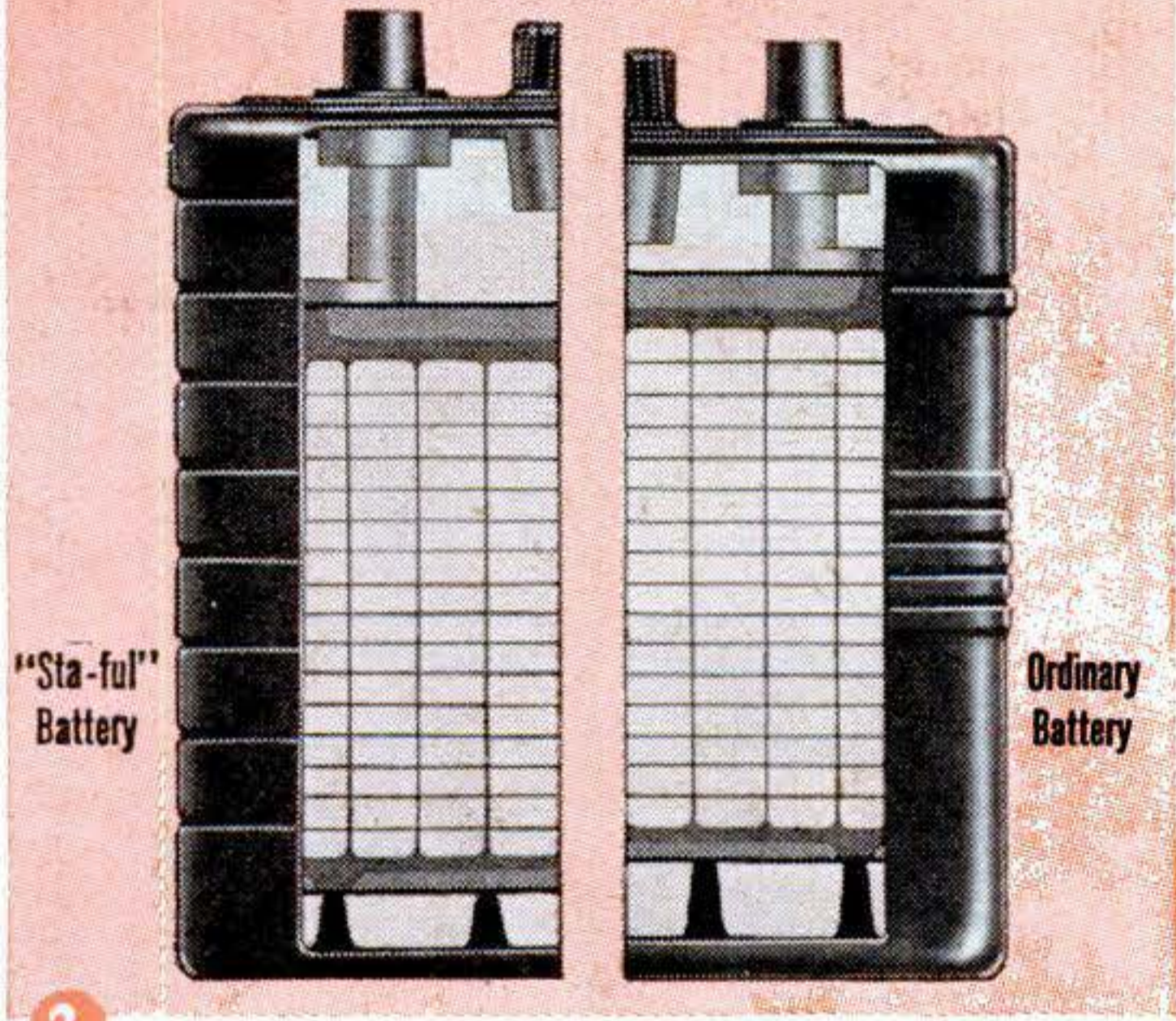

FIRST STAGE OF EVAPORATION
Equal liquid loss from both batteries

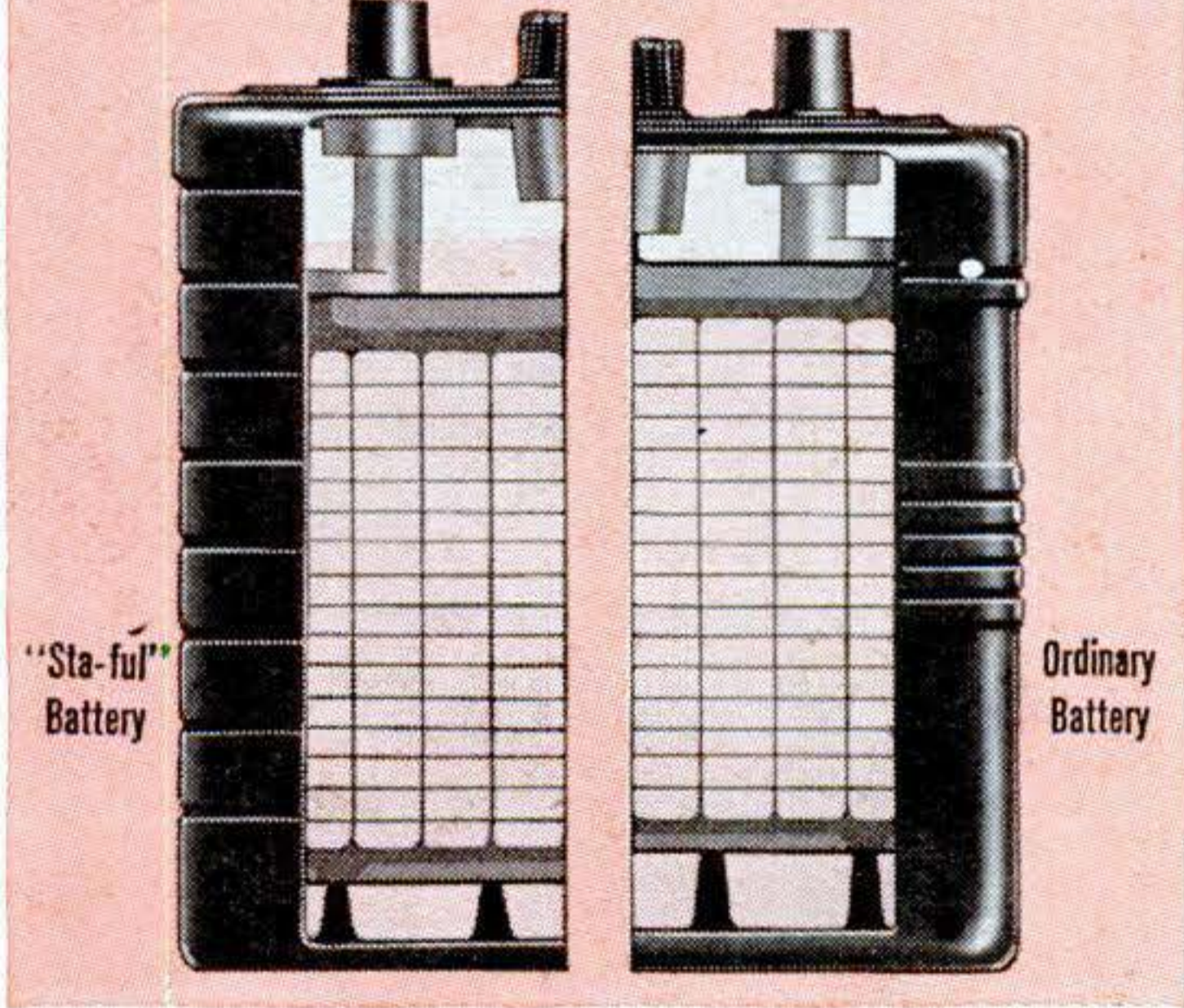

ADVANCED STAGE OF EVAPORATION
Equal liquid loss from both batteries

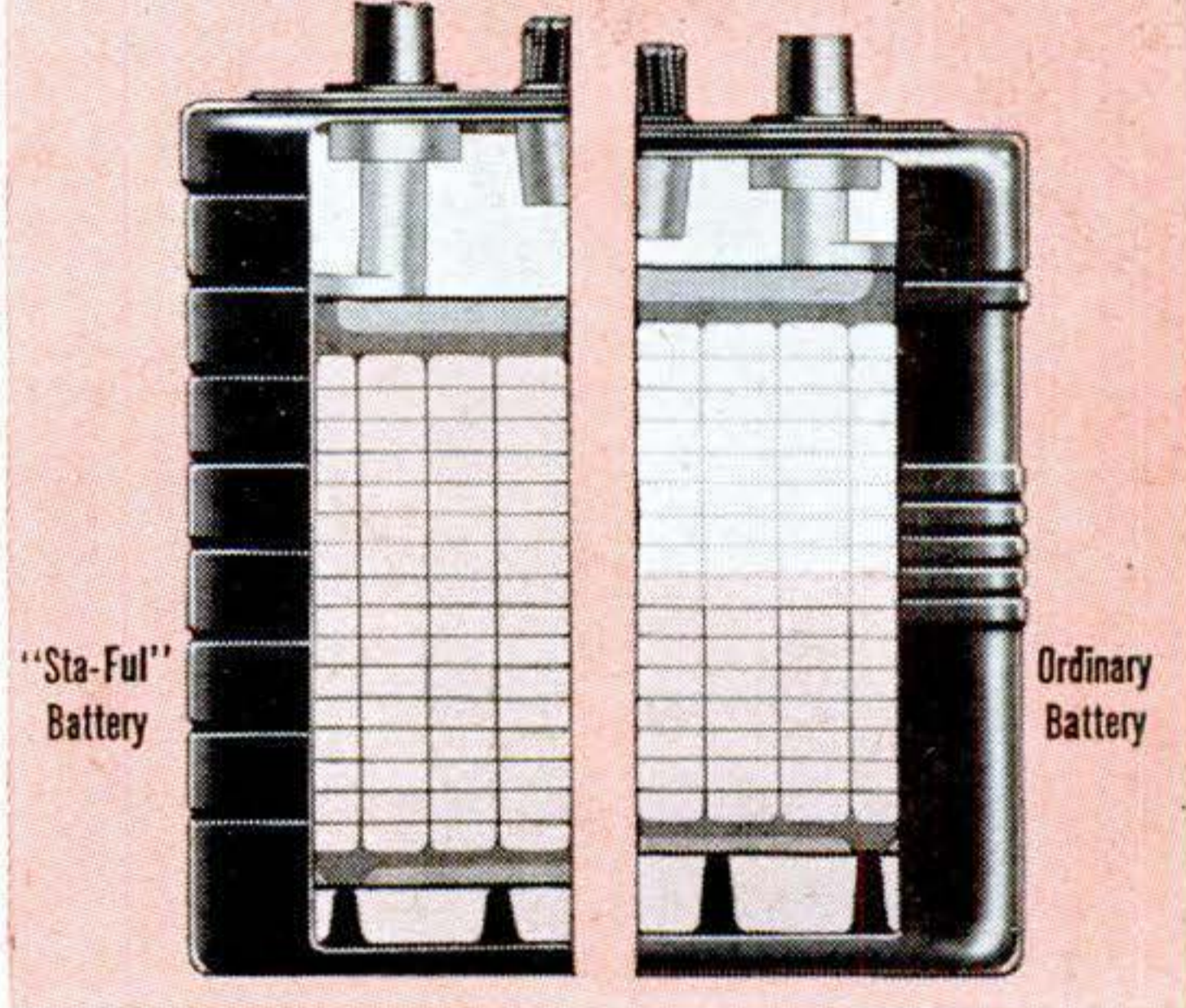

LASTS LONGER TOO! *In normal car use, because of "Sta-ful's" extra liquid reserve, plates are kept submerged to help deliver full life and power, when the same liquid loss leaves the plates in ordinary batteries exposed and inactive. This "Sta-ful" principle, oversize electrical capacity, plus Fibre-glass insulation, give longer life than batteries without Auto Lite "Sta-ful" features.

AUTO-LITE BATTERY CORPORATION
Toledo 1, Ohio

AUTO-LITE



NO OTHER TOOL LIKE IT



BURGESS vibro-tool

Trade Mark Reg. U. S. Pat. Off.

- WRITES ON STEEL
- DECORATES GLASS
- ENGRAVES JEWELRY
- CARVES WOOD
- TOOLS LEATHER
- CUTS CARDBOARD

Works by Vibration!

Whether you work with metal, wood, glass, plastics or leather, your shop is not complete without a Burgess Vibro-Tool. Totally unlike anything else on the market! Writes like a pencil on hardest steel! Engraves, carves, hammers and cuts. Only \$7.50 at your dealer. If he cannot supply you, write to us and we will arrange for shipment.

**BURGESS
BATTERY COMPANY**
Handicraft Division
Lake Zurich, Illinois

ORDER REPLACEMENT ACCESSORIES NOW!

- V 5 Standard Needle.. \$0.15
- V 3 Heavy Duty Needle.\$2.00
- V 80 Diamond Point Needle \$5.95
- V 81 Point for Frosting Glass \$0.75
- V 82-87 Leather Tools including punch, liner, deerfoot, spoon, double liner and cupper \$1.50
- V 23 Straight Edge Surgical Steel Knife.....3 for \$0.50
- V 24 Belly Edge Surgical Steel Knife.....3 for \$0.50
- V 101 Foot Gauge for use with knives to regulate cut depth.....\$0.95
- V 51-56 Assorted Carving Chisels.....6 for \$1.50
- V 44-48 Assorted Ball Points 5 for \$0.95
- V 41-43 Assorted Hammer Tips 3 for \$0.25
- V 115 Sharpening Stone \$0.25

DE LUXE KIT only \$16.50

Contains Vibro-Tool and 22 attachments, everything necessary for metal marking, jewelry engraving, leather tooling, wood or linoleum carving, pattern cutting, metal embossing, etc. Includes sharpening stone. Each unit individually packed in handsome, natural finish, wood storage chest. An ideal gift for any hobbyist.



BURGESS BATTERY COMPANY
Handicraft Division, Lake Zurich 23, Illinois

Please arrange for a Vibro-Tool dealer to ship the following:

- Vibro-Tool De Luxe Kit Accessories Enclosed find remittance Ship C.O.D. } Please list parts wanted by number

NAME.....

ADDRESS.....

.....

Foredom PRESTO-FLEX



NOW! For Only \$5.95 You can have an Amazing New FLEXIBLE SHAFT TOOL

with PENCIL-SIZE HANDPIECE

Grinds, Polishes, Sharpens, Cleans, Mills, Carves, Engraves, Etches on Metal, Wood, Glass, and Plastic

Now you can turn your old motor, drill press, or electric drill into a Flexible Shaft Tool. Amazing new Presto-flex, latest addition to the Foredom flexible shaft family. Simply attach to your electric drill, drill press or motor. Presto—a flexible shaft machine! Off again in a jiffy! Pencil size handpiece gives you finger-tip control. Gets into tight places you can't reach with any other tool. Handy 35" overall length. And—only \$5.95 complete! Order NOW.

—SEND NO MONEY—

Just send your name and address. We will rush your Presto-flex COD. Pay postman \$5.95 plus postage or send \$5.95 now and WE pay postage. Money back if not delighted! If you order Presto-flex for use on motor, specify motor shaft diameter and add 50c for motor coupling. (Available for 1/4", 5/16", 3/8" and 1/2" shafts.) 50 piece accessory set available \$1.50 extra. Order TODAY from

FOREDOM ELECTRIC CO.

Dept. 152

Manufacturers of Flexible Shaft Equipment for Home and Industry For a Quarter-Century.

27 PARK PLACE • NEW YORK 7, N. Y.

**V-8
DUALS
& SINGLES**

MUFFLERS
STEELS and ALUMINUMS
with a motorboat tone

SINGLES, Chev, V-8, Plymouth, Steels \$5.50, Aluminum \$6.50. Chry., Olds., Buicks, etc., Steels \$7.50, Aluminum \$8.50. V-8 and MERCURY DUALS, Steel \$17.50, Aluminum \$20.00. Aluminums are guaranteed for life of your car.

DEALERS WANTED

SANDEE MUFFLER CO.
7523 S. WESTERN AVE., LOS ANGELES 44, CALIF.

SAVE HANDS SAVE TIME



with Steel-Grip Gloves

The best opportunity for lower costs lies in speeding production. Keep materials moving with Steel-Grip chrome tanned cowhide gloves. Steel ribbons over tough leather strips; palm and fingers reinforced, for utmost wear. Handle rough, heavy, sharp materials with speed and safety and sureness. Or what's your problem? Over 4300 proven Steel-Grip safeguards may give you an immediate answer. Used by big industrials since 1910. Write for catalog or state your need today.

INDUSTRIAL GLOVES CO.
653 Garfield, Danville, Illinois
(In Canada: Safety Supply Co., Toronto)

Snap-on Basic ELECTRONIC CONTROL SERVICE TOOL KIT

▶ . . . cuts "down-time" to a minimum
. . . speeds maintenance . . . because
you always have the right tool
at the right time

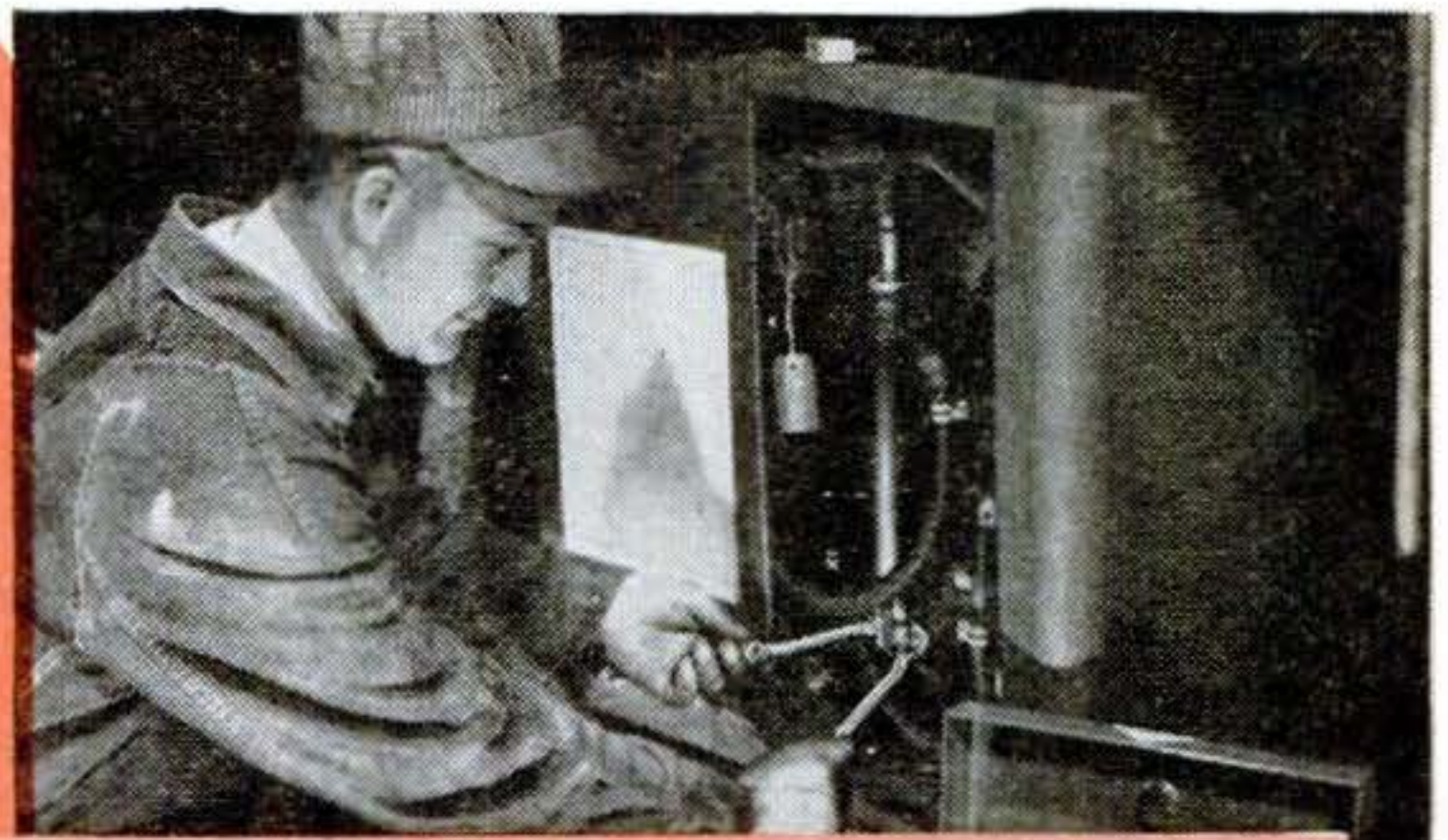

▶ A made-to-order, "tested-on-the-job" kit to service Electronic Controls, Panels, Relays . . . Heat Control Panels . . . Spot Welding Timers . . . Small Hoist Controls . . . and Welding Machine Starters.



This complete 51-pc. kit
with Handy Hold-all Box
for only **\$48⁴⁷**

Actually tested in the shops where "down-time" must be held at an absolute minimum, this kit has proved its value over and over again. It contains all the basic tools you will need . . . and they're Snap-on tools, built and sized to precision tolerances with the *feel* and *balance* that gives you fast nut-turning efficiency. Check the complete list at the right . . . tear out coupon and mail today.

SNAP-ON TOOLS CORPORATION
8060-L 28th AVENUE • KENOSHA, WISCONSIN
International Division: Kenosha, Wisconsin, U. S. A.

- Including . . . Ratchet, Sliding Tee Nut Spinner, Flextation Plastic Grip Handle Universal Joint 2" and 6" extension 8 Hex. Sockets $\frac{1}{8}$ " to $\frac{7}{16}$ " 8 Deep Hex. Sockets $\frac{1}{8}$ " to $\frac{1}{2}$ " 3 Square Sockets, $\frac{1}{4}$ ", $\frac{5}{16}$ ", $\frac{3}{8}$ " 4 Dwarf Boxsockets $\frac{1}{8}$ " to $\frac{3}{4}$ " 8 Ignition Wrenches $\frac{3}{32}$ " to $\frac{3}{8}$ " 1 $9\frac{1}{4}$ " Screw Starter Tungsten Ignition File 6" Mill Bastard File 5" Gripper Pliers

- 6" Diag. Cutter Pliers
6" Needle Nose Pliers
3 Screw Drivers
4" Offset, $1\frac{1}{2}$ " and $2\frac{1}{2}$ " Stubby, plus a 3" and 4" blade.
1 Red Hold-all Box

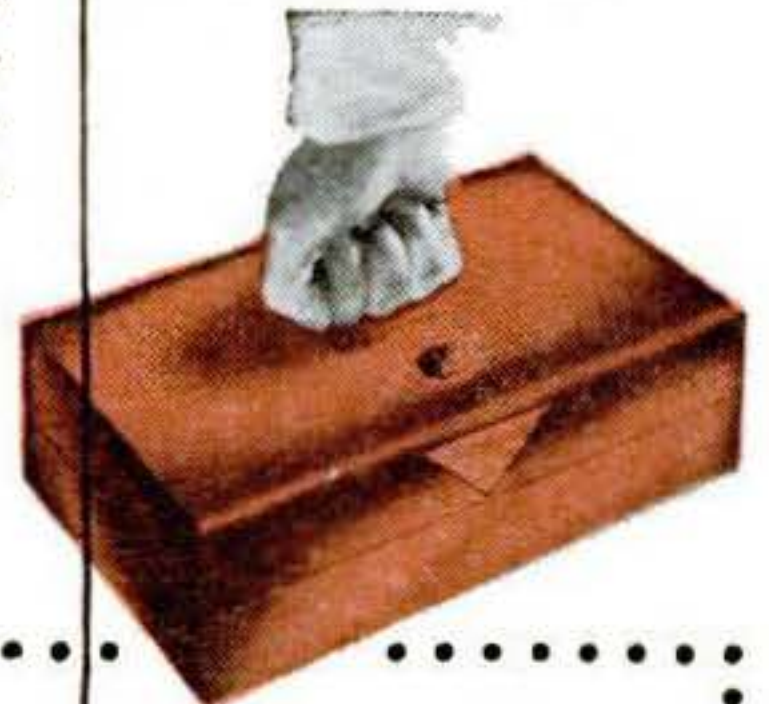

Please send me the \$48.47 Electronic Control Service Kit. No. TM-151. I am enclosing . . .

Check Money Order Company Purchase Order

Name.....

Company.....

Address.....

City..... Zone.....
(.....) State.....



Merry Christmas
TO YOU FROM YOU

**7"-8" TILT/ARBOR
TABLE SAWS
\$37.75
and up**

**15" JIG SAW
\$29.75**

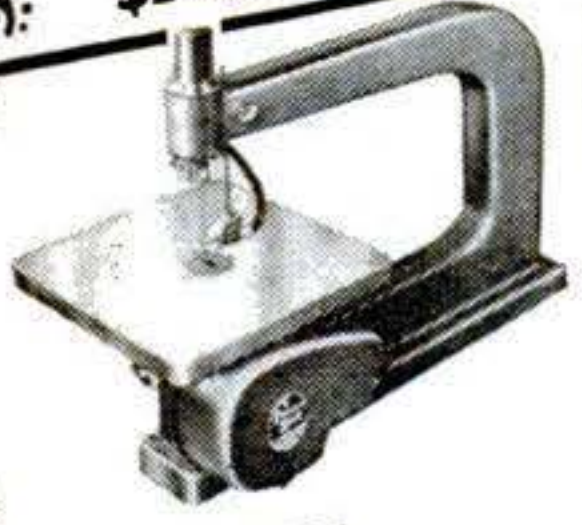

**BAND SAW
\$75.00**

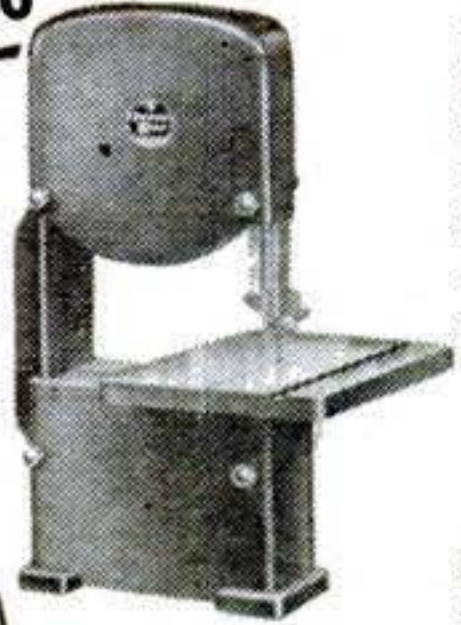

**SPINDLE
SHAPER
\$42.75**

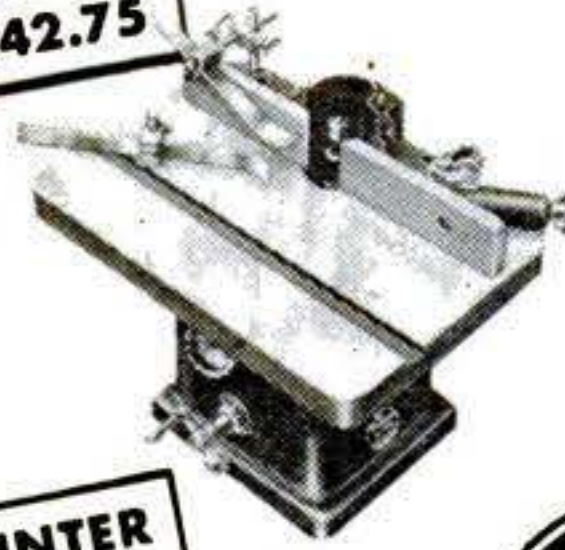

**JOINTER
PLANER
\$39.75**



**9"-12"
WOOD LATHES
\$35.00 and up**

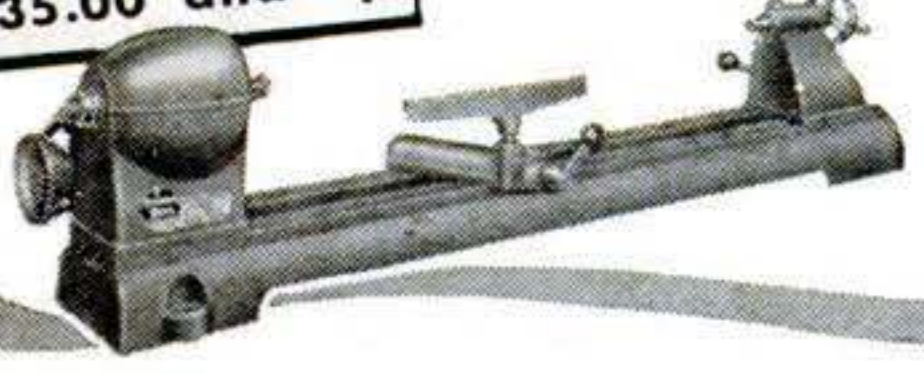

**DRILL
PRESS
\$37.75**



POWER KING WOODWORKING TOOLS

Power King tools for your home shop — there's a gift the whole family will enjoy for a lifetime! Furniture, cupboards, cabinets, toys . . . anything in wood that your home needs . . . can be made easily and inexpensively with fast Power King tools to help.

Quality at a Price

PK tools give you design and construction excellence far beyond their low price. They're rugged, compact, accurate — built for years of smooth service.

So tell the family you're going to buy your own gift this year. Send a postcard for new catalog sheets describing all the tools and the name of your nearest Power King dealer.



**POWER KING
TOOL CORP.**
1235 Cleveland St.
Warsaw, Indiana

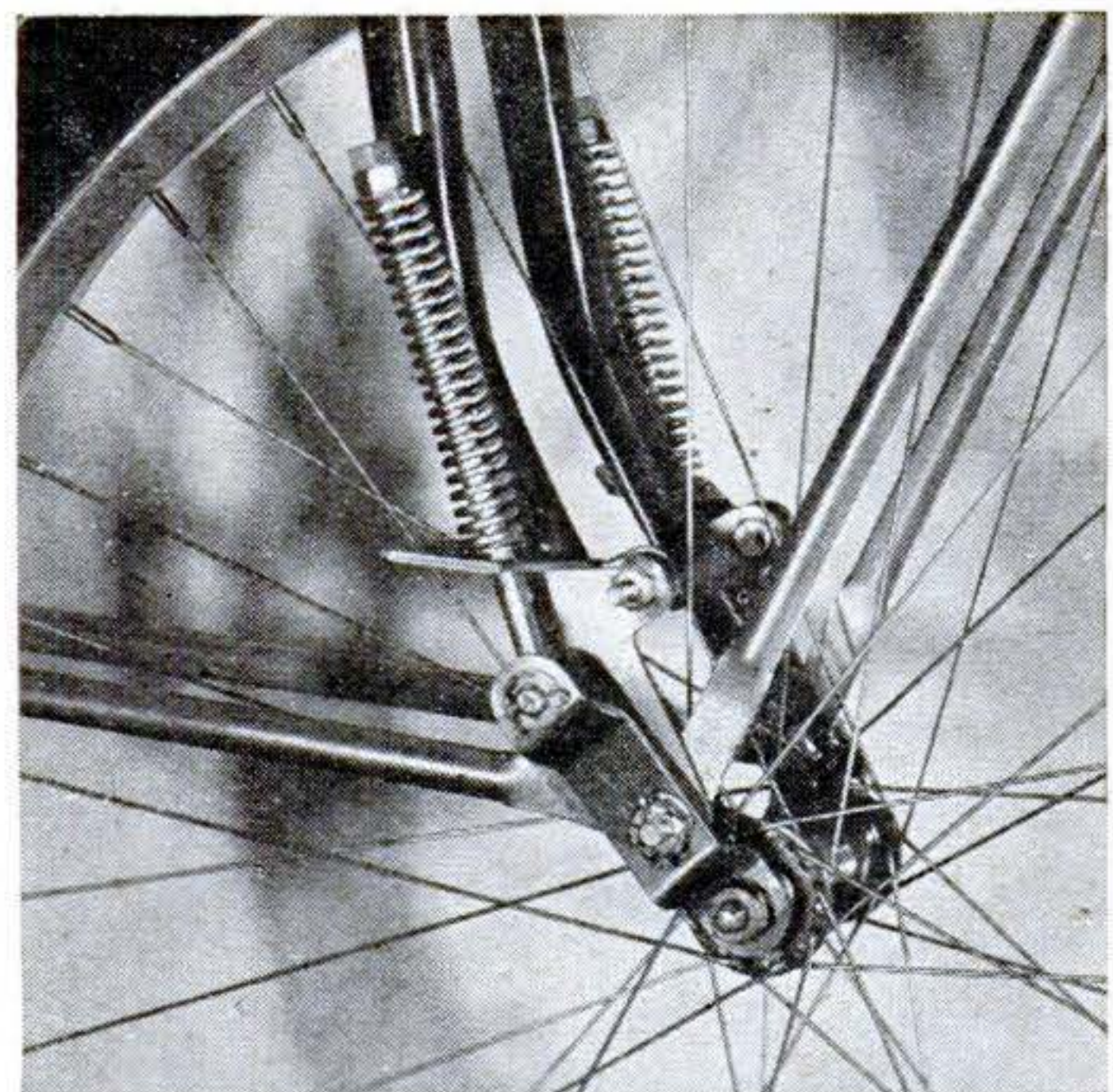

Bike Springs Ease Ride

A FAR cry from the high-wheeled, hard-tired bikes of old, the newest accessory for the comfort of present-day peddlers is a shock absorber for bicycles and motorbikes. Made by the Witherell Co., of Detroit, the double-spring device is easily attached to a bike's front-wheel fork. Its spring action, similar to that of motorcycle shock absorbers, helps cushion rough-road bumps.

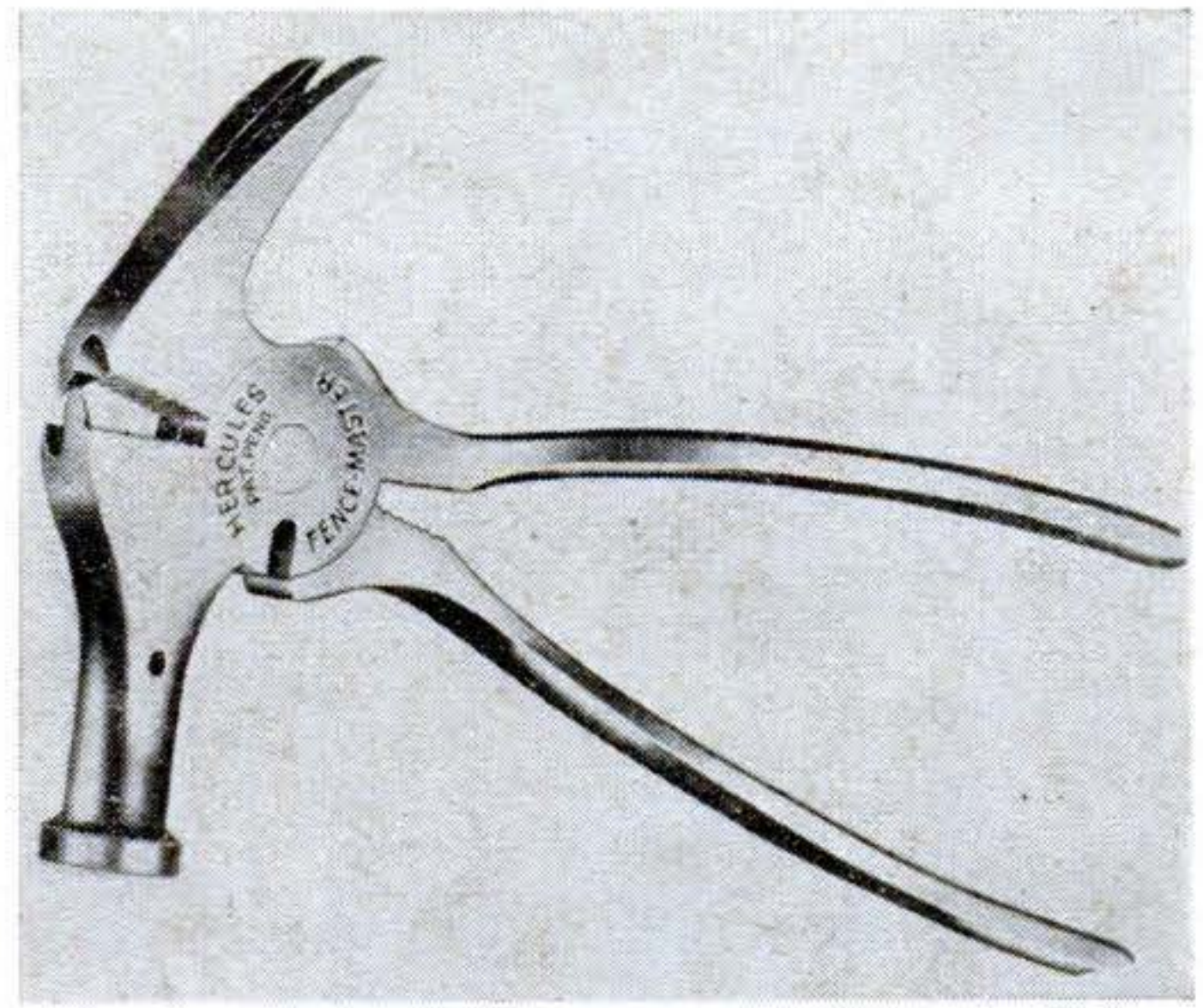

Tool Fills Fence Needs

DESIGNED to perform all the jobs of an entire set of fence tools, this single, all-in-one building and repair tool is a combination hammer, ripper and pair of pliers. No larger than a small claw hammer, it splices, cuts and stretches wire, and pulls nails and staples. Made by the Hercules Forge Corp., of Los Angeles, the 10¼-inch-long, nickel-plated fence tool weighs only 1½ pounds.

Merry Christmas
TO YOU
FROM YOU

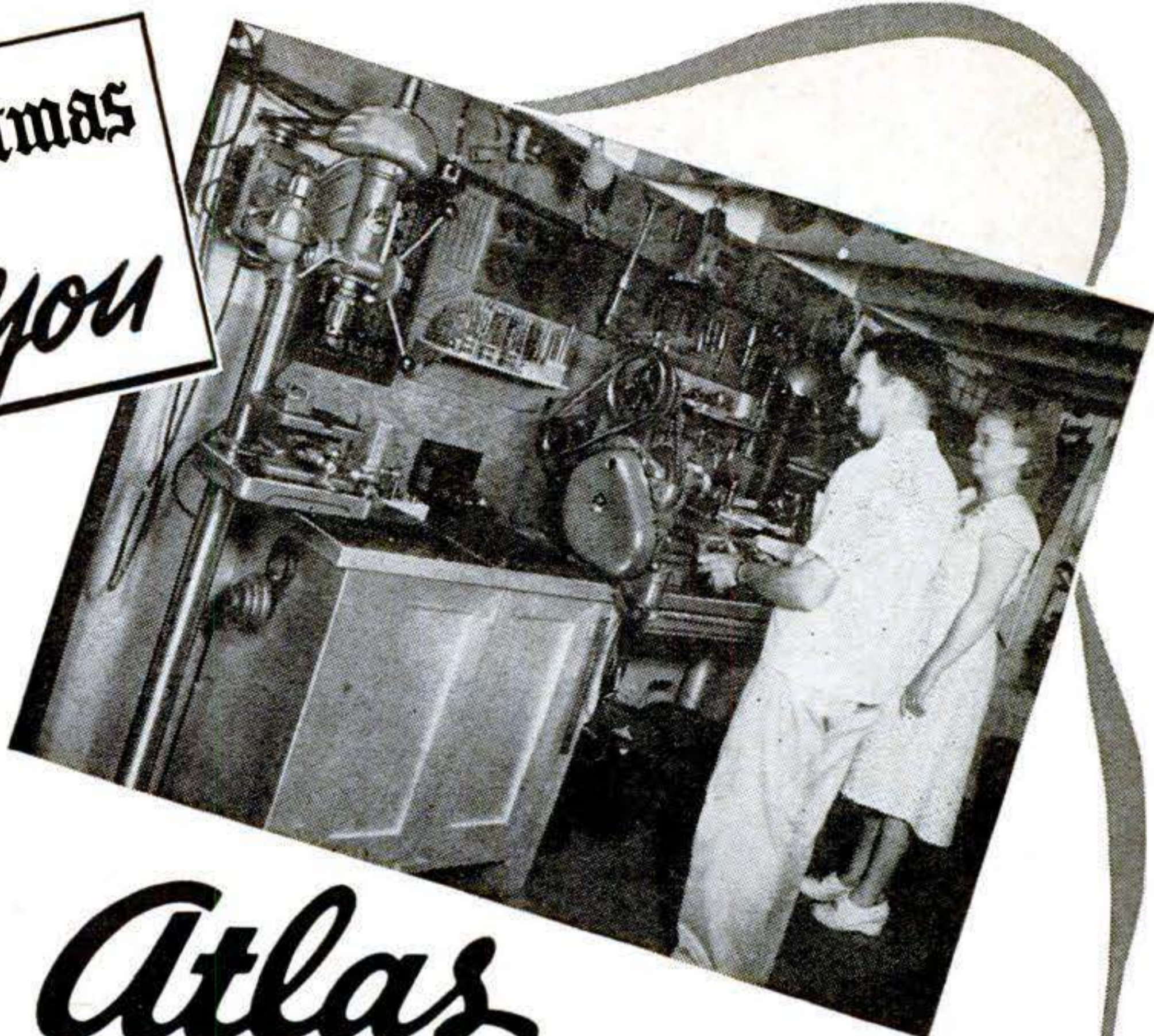

DRILL PRESSES
\$53.50 and up

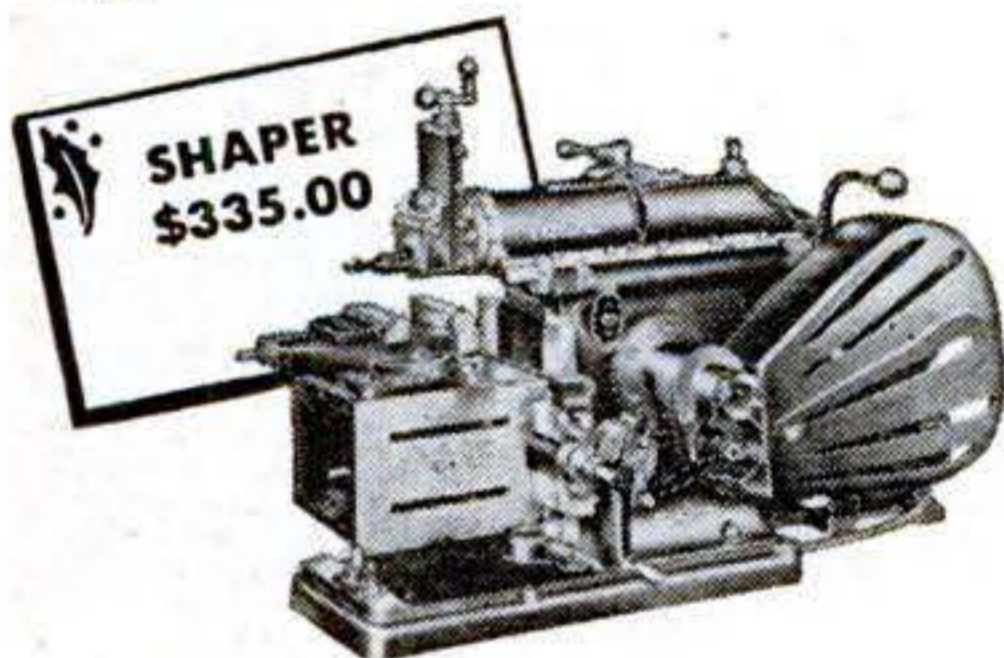

SHAPER
\$335.00

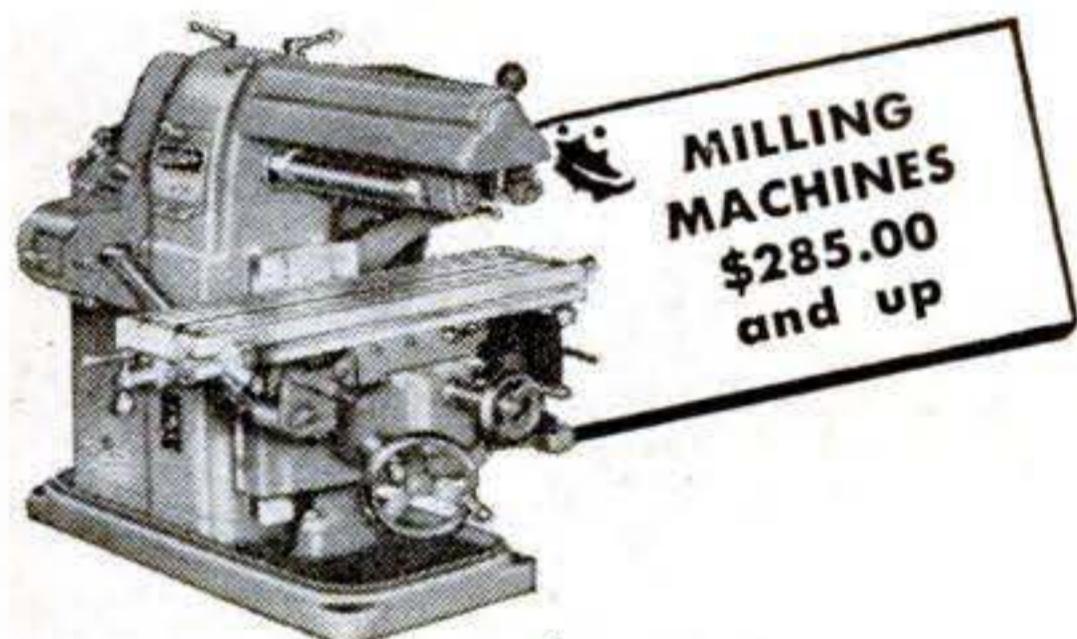

MILLING
MACHINES
\$285.00
and up

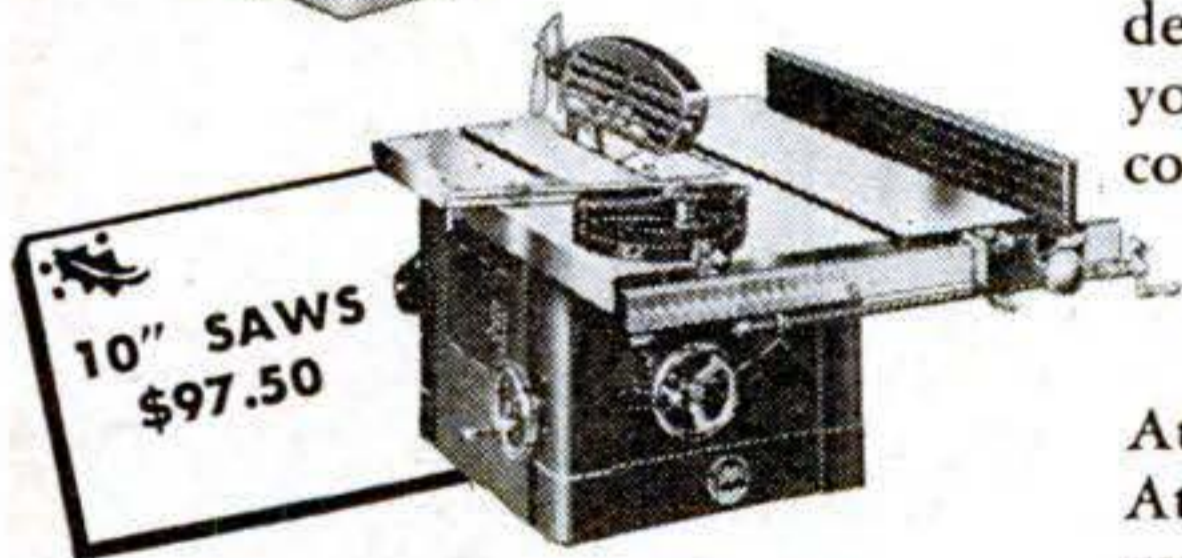

10" SAWS
\$97.50

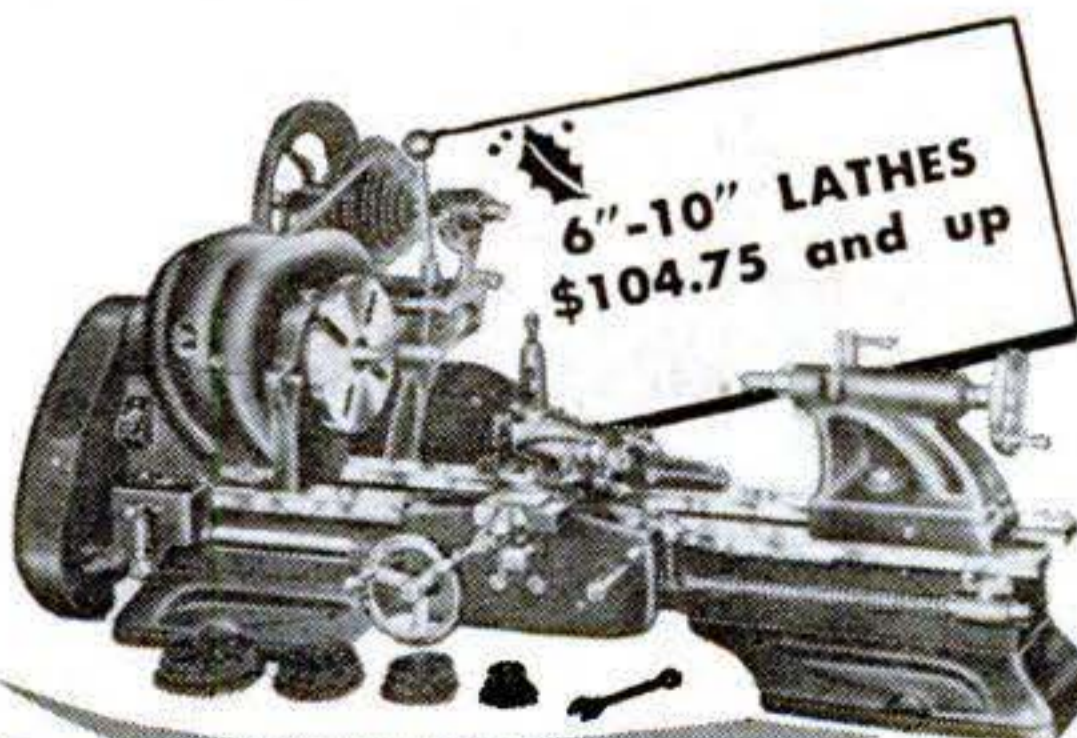

6"-10" LATHES
\$104.75 and up

Atlas PRECISION TOOLS

Give yourself a Christmas package this year — of Atlas equipment for your shop. There's a lifetime of fun and healthful relaxation for you in Atlas tools. And they're might practical too. The whole family will enjoy the host of useful and attractive articles you'll make in metals, woods, and plastics — the tools will save on home equipment repairs — and they'll be invaluable if you decide to develop your ideas into a profitable business.

Industrial Standards for Your Home Shop

Atlas precision tools are top quality throughout — compact, rugged, built to exacting industrial specifications. They offer all the time and work saving features demanded by commercial users. No matter how rigid your tool requirements, you'll find Atlas meets them completely.

Years of Practical Usefulness

Years of dependable service are engineered into every Atlas tool. And they are reasonably priced. Your nearby Atlas distributor will be glad to have you inspect the many features at your leisure. And he probably has a convenient payment plan if you prefer to buy that way. See him today or send for his name and latest catalog.



ATLAS PRESS COMPANY
1255 N. Pitcher Street
KALAMAZOO MICHIGAN



A TOOLSHOP IN YOUR HAND!

- GRIND • DRILL • ROUT
- POLISH • ENGRAVE
- CUT • SAND • SAW • etc.

MAKE THINGS FROM WOOD
PLASTICS—METALS—GLASS
LINOLEUM—LEATHER
ALLOYS—HORN—STONE
BONE, etc.

HANDEE TOOL OF 1001 USES

THE FIRST TOOL OF THIS KIND—TODAY'S FINEST!
Smooth, steady power at your fingertips! Perform precision operations not possible with any other portable tool! With a Handee you can turn out professional looking projects for pleasure or profit—ship, plane and train models, delicate, internally carved costume jewelry, wood carvings, puppets, initialed tumblers, etc. AC or DC. 25,000 r.p.m. Wt. 12 oz. Over 500 accessories made especially for the Handee!



A GOOD START—THE HANDEE KIT

HANDEE Tool and 40 most popular accessories packed in compact steel carrying case. You'll be amazed at what you can accomplish! At stores or postpaid **\$27.50**

Handee only, with 7 accessories, \$20.50

FOR YOURSELF OR A FRIEND...
THE GIFT OF A LIFETIME!



NEW PLASTIC-CRAFT KIT

For internal carving. Contains special plastic cutters, buffers, sanding discs, buffing compounds, a liberal supply of clear plastic, dyes, cement and instructions. At stores or postpaid **\$6.95**

GET A HANDEE at stores everywhere. If they can't supply you we'll send it postpaid. Satisfaction guaranteed. Free 52-page Manual on request.

CHICAGO WHEEL & MFG. CO.
1101 W. Monroe St. Dept. PO. Chicago 7, Ill.

Send Handee Kit Handee Tool Plastic-Craft Kit
 C.O.D. Remittance enclosed Send Manual

Name.....
Address.....
.....

BRIGHT STAR

GIVES
MORE
BRIGHT
LIGHT
LONGER



Always Keep a Bright Star Flashlight Handy

Sand Casting—Forging—Heat Treating—Case Hardening
BRONZE FOUNDRY

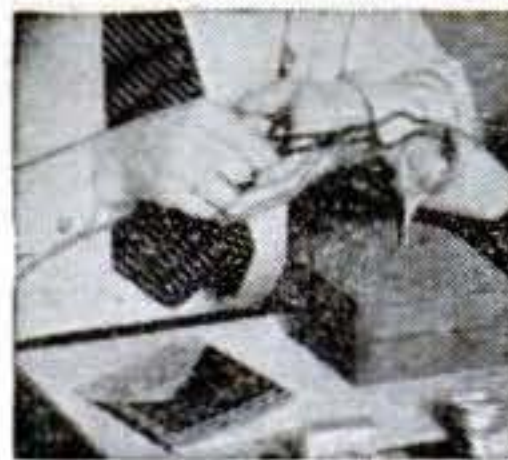

is again available in limited quantity without priority. Orders filled in sequence as received. **INVENTORS-SCHOOLS-CRAFTSMEN** use **FOUNDRYETTE** for making castings quickly for new inventions, for instruction, and general purpose. Order now for early delivery. Three sizes are available capable of making bronze castings of 1½, 3, and 6 pounds weight, aluminum, copper, brass, etc. Domestic gas supply and 110 volt AC or DC energy required for operation. Write for circular.

KANSAS CITY SPECIALTIES CO.
Box 6022, Dept. S-L5 Kansas City, Mo.

Say You Saw
It In Popular Science

ELECTRICITY *Anywhere*



for
HOMES
FARMS
SHOPS
BOATS
RADIO
USE

Onan gasoline-engine-driven Electric Plants supply reliable, economical electric service for any use. Portable, stationary or stand-by models. Water or air-cooled, compact and rugged.

A.C.: 350 to 35,000 watts in all standard voltages and frequencies. D.C.: 600 to 10,000 watts, 115 and 230 volts. **BATTERY CHARGERS:** 500 to 3,500 watts; 6, 12, 24, 32 volts.

Write for folder

D. W. ONAN & SONS INC.
2778 Royalston Ave., Minneapolis 5, Minn.



SENSATIONALLY NEW!

YOUR CIRCLE SAW CAN
CUT GROOVES LIKE THIS

Easily - - - Quickly - - - Accurately

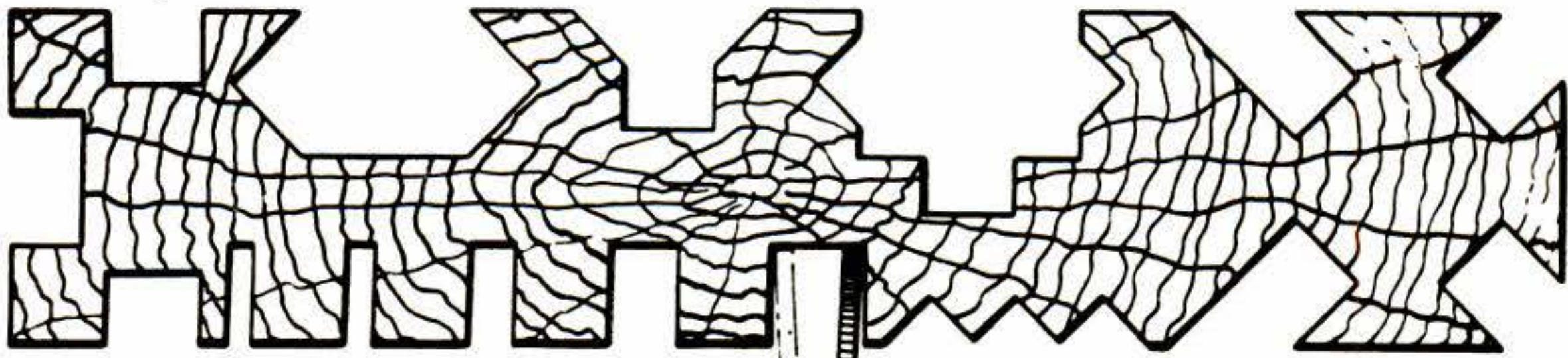

Yes—This new invention will fit the arbor of any wood power circle saw—and it will saw any groove desired, cleaner, easier, and faster than any dado head on the market today . . . Once mounted, Warren Dado Sawing Washers can be left as a permanent part of your power saw . . . always accessible and quickly adjusted from use as a straight cut off saw to any width groove desired.

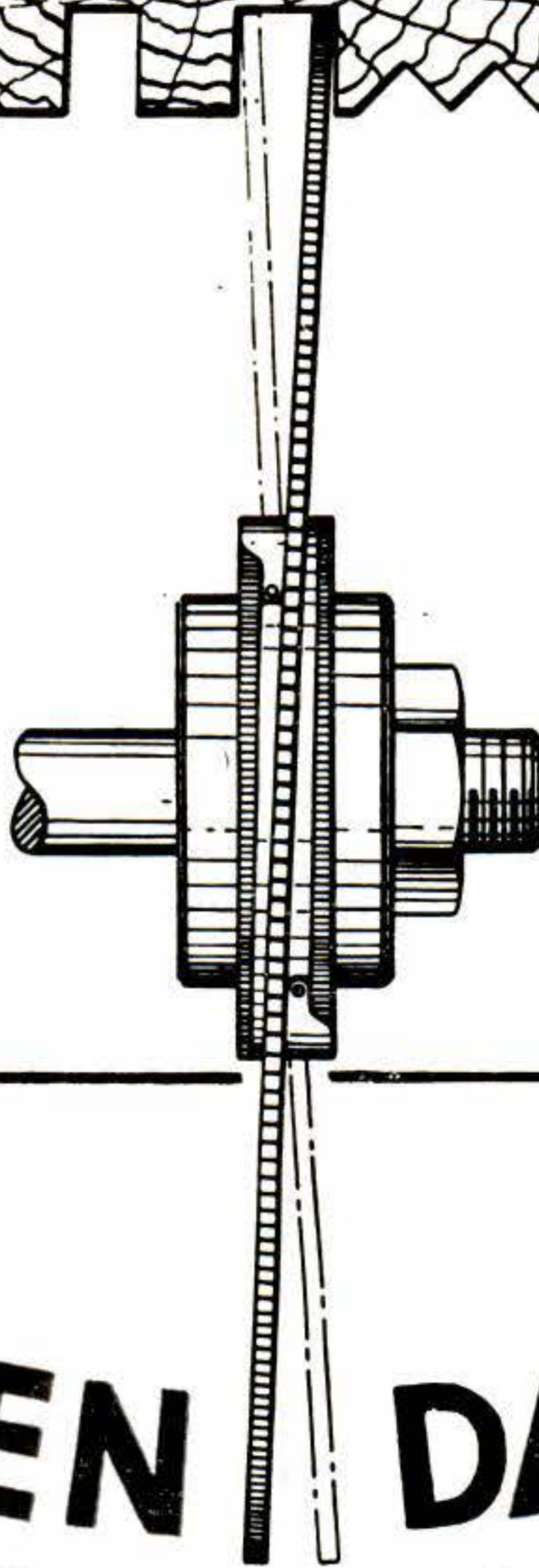

Warren Dado Sawing Washers are precision diecast aluminum alloy. There are four washers to a set—one pair for each side of the saw blade . . . graduated in 32nds and numbered to cut the width groove desired.

Use the coupon below and order your set today at this low mail order price.

\$ 4.95
SET
POSTPAID
INC. TAX

The WARREN SAWING DADO WASHERS

Patent Applied For

— GUARANTEE —

Use Warren Dado Sawing Washers for 10 days. If you are not thoroughly satisfied, send the washers back and your money will be refunded.

WARREN DADO SAWING WASHERS CO.

P. O. Box 98, North End Station Detroit, Mich.

Please send me a set of washers as advertised.

Name.....

Address.....

City..... Zone..... State.....

Arbor Size 1/2 3/8 3/4 1

Circular Only

Enclosed is... Money Order Check

PS

WARREN DADO SAWING WASHERS CO.
P. O. Box 98, North End Station Detroit, Mich.

Big Smile



Great Saw

• Picture a man getting his hands on an Atkins the first time. He tries it out—makes a cut or two. And then—a big smile. Because it's a great experience to feel the keen teeth eat their way through the wood smoothly, almost effortlessly—and make a true, accurate cut.

Atkins Silver Steel makes great saws—saws that hold an edge for many hours of pleasurable cutting. For a big smile, use a great saw—use an Atkins.



ATKINS

E. C. ATKINS AND COMPANY
INDIANAPOLIS 9, INDIANA

252 POPULAR SCIENCE

MORE
Good Implement Dealers
Sell Bolens HUSKI
Than Any Other Garden
Tractor!



YOUR NEARBY BOLENS HUSKI DEALER is a good man to know, for he's sincerely interested in selling and serving you the best. Let him show you the complete Bolens HUSKI line of economical 2-Wheel Tractors and "Packaged" Implements for plowing, harrowing, seeding, fertilizing, cultivating, mowing, snowplowing. All tools easily, quickly attached. 2 popular models—3 H.P. Gardener—1½ H.P. Power-Ho. Buy attachments when and as needed.

WRITE TODAY for name of nearest dealer and illustrated literature.

BOLENS PRODUCTS DIVISION

Bolens HUSKI
2-WHEEL
TRACTORS

FOOD MACHINERY CORP.
267-C Park Street
Port Washington, Wisconsin

The Standard for Over 30 Years

MACHINE SHOP EQUIPMENT



Just off the press!—Every man who owns a workshop should have a copy of our new, up-to-the-minute, 200 page catalog of Machine Shop Equipment—the latest tools made by the biggest manufacturers in the U. S. Replete with illustrations, descriptions, prices. Prompt delivery on most tools listed in this book. Available at cost of printing—50c a copy—get yours today! **Price of Catalog Refunded on First Order over \$5.00.** Send Check or Money Order to

CENTER TOOL CO., 153 Centre St., Dept. D, N. Y. C. 13

Say You Saw
It In Popular Science

Get an Electric **FREE**
SOLDERING IRON
and assemble your own . . .



Magi-Klips Kit

This is the same MAGI-KLIPS Radio & Electronic Experimenter's Kit—complete with all parts—that we sell ready assembled for \$29.75.

In knocked-down form with full instruction for assembly, it is now offered at the new low price . . . **\$19.75** complete with a new Electric Soldering Iron—ideal for wiring your unassembled MAGI-KLIPS Kit.

Send for your copy of FREE booklet, "Electronics Made Easy."

DEER & TAYLOR COMPANY

Dept. M, 1342 Milvia St.

Berkeley 9, California

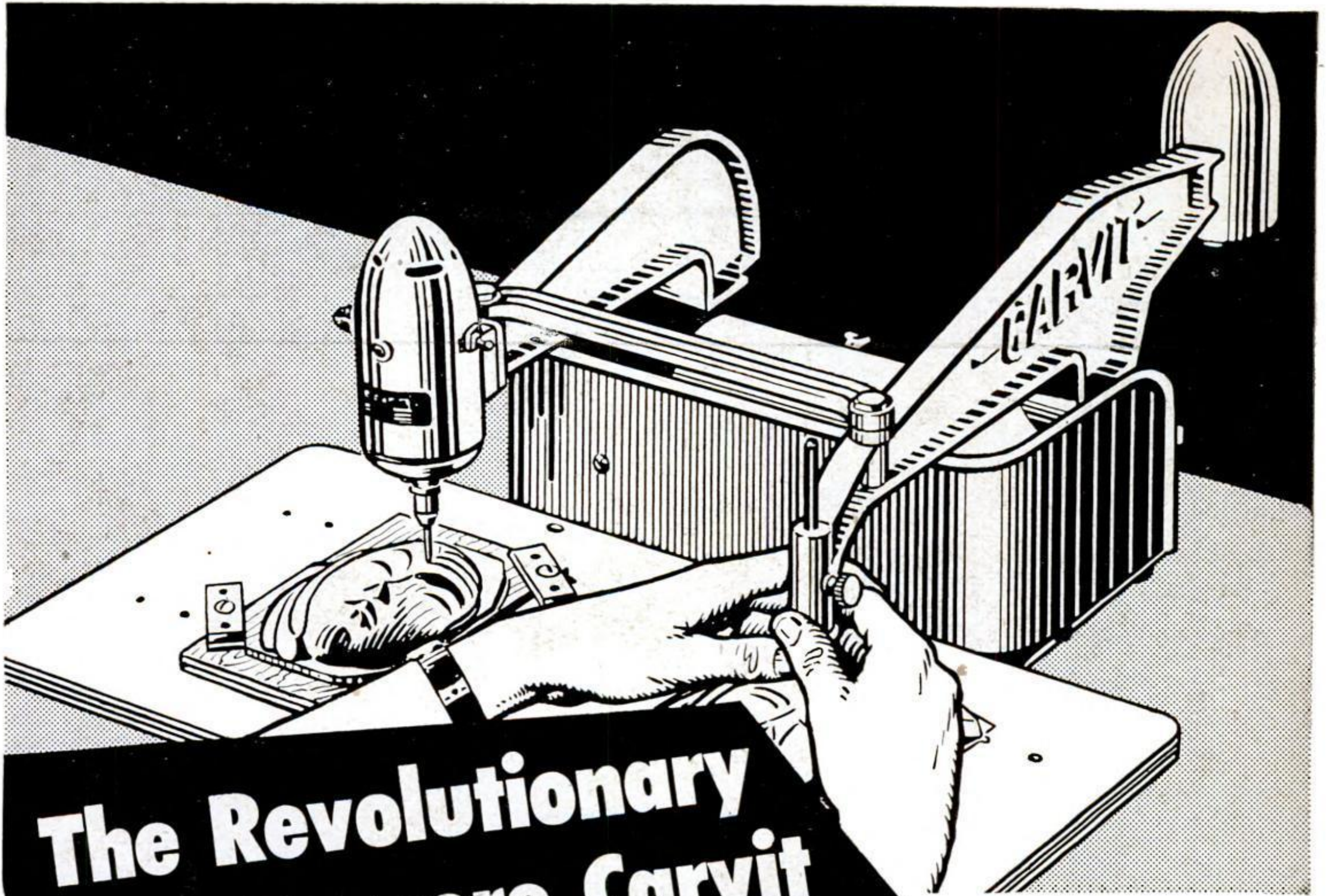

The Revolutionary New Dumore Carvit

**makes you a skilled
wood-carver in 20 minutes!**



**No skill or training needed
to do work like this**

Carve useful ornaments for
the home — distinctive gifts
— fine carvings that *sell!*

Here's a fascinating new hobby — complete in one tool. Making fine wood carvings with the Carvit is so simple a child can do it! The unbelievable perfection of your first carving amazes your friends! Experienced craftsmen use the Carvit to give their woodworking projects that *real* professional touch.

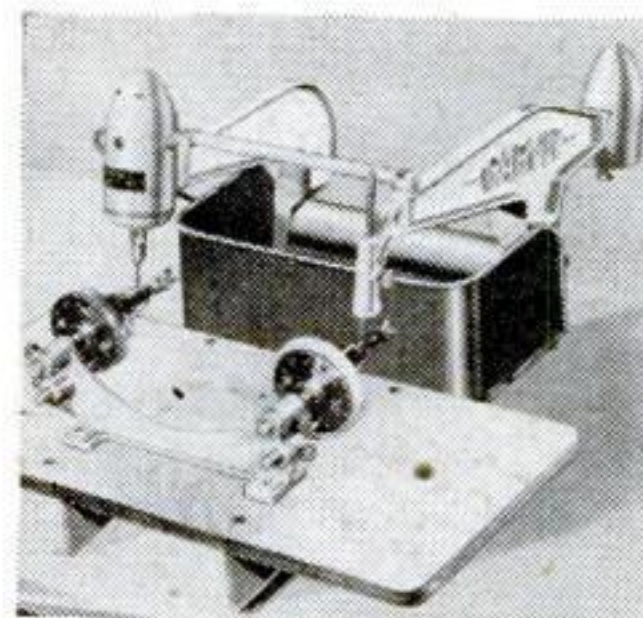

With an index attachment, the Carvit reproduces objects in the round — statuettes, and busts.

With the Carvit, you make beautiful replicas of inexpensive objects you can find in any dime store or gift shop — reproducing them in mahogany, walnut, and other fine woods. Your carvings are many times more beautiful and valuable than your original models!

You're an expert at once — with a Carvit!

Here's how the easy-to-use Carvit works: You clamp a model to the table below the tracer, and a wood block below the cutter. Then you switch on the motor and guide the tracer over the raised contours of your model. The cutter moves with the tracer to carve an

exact duplicate of the model.

Carving with the Carvit is fascinating fun for everyone. The Carvit is *the ideal gift for your sweetheart, husband, or son!* See the Carvit at your local hardware store today — or mail us the coupon below!

The Dumore Company, Dept. M-52, Racine, Wisconsin

- Please send complete information on the Carvit.
- Please send one Carvit. \$48.50 enclosed.
- Please send one Carvit with index attachment. \$58.25 enclosed. Shipping charges C.O.D.

Name.....

Address.....

City..... (.....) State.....

H-8A

**Satisfaction
guaranteed or
your money back
in 10 days!**

**Tear out coupon
and mail today!**

FREE!



SEND FOR
ALLIED'S
BIG 164-PAGE
RADIO
CATALOG

Everything in Radio at Lowest Prices!

Here is *everything* you want in Radio! New home radios and phono-radios, Ham receivers and gear, new kits, thousands of parts, tubes, tools, complete PA equipment, diagrams, latest radio books. The most complete stocks anywhere—in one *big* book—all at money-saving low prices!

BUILD THIS AMAZING 5 TUBE RADIO

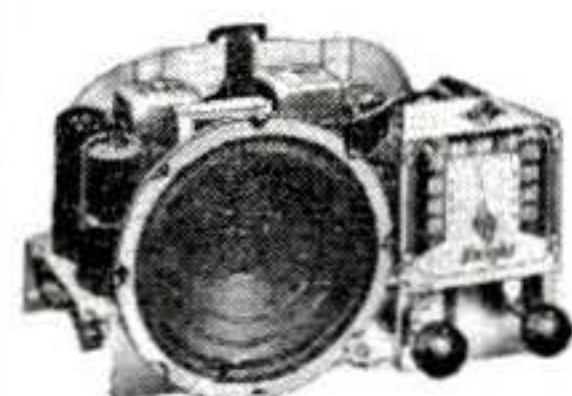
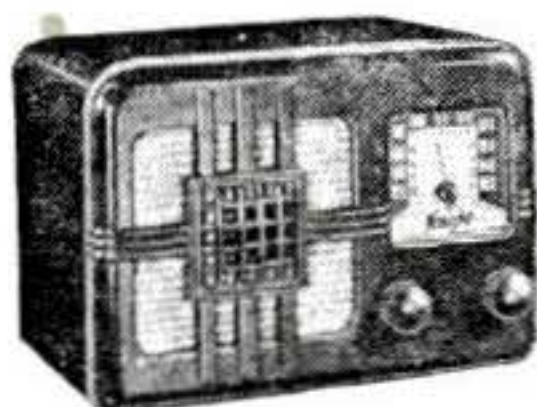

LOW-COST SUPERHET KIT
Complete with Plastic Cabinet, Loop Antenna, and Tubes

It's here! The first ultra-modern 5 Tube AC-DC Superhet kit at so low a price! Here's what you get—full broadcast band coverage (550-1600 Kc); built-in loop antenna;

latest 5" PM dynamic speaker; handsome walnut plastic cabinet. Unbelievably easy to build; no special tools required. Sockets are riveted in place on chassis base; just assemble, wire and slip into cabinet. Outstanding for power and tone quality. Highest grade components only. Complete with all parts, tubes and full instructions. **ONLY \$14.95** Nothing like it at the price! Shpg. wt., 10 lbs. No. 83-275. Complete.....

GET THESE VALUABLE ALLIED RADIO BOOKS!



- Radio Formulas & Data No. 37-752...10c
- Dictionary of Radio Terms No. 37-751...15c
- Radio Circuit Handbook No. 37-753...25c
- Radio Builders' Handbook No. 37-750...15c
- Simplified Radio Servicing No. 37-755...10c
- Radio Data Handbook No. 37-754...25c
- ALL 6 BOOKS above No. 37-799...\$1.00
- Parallel Resistance and Series Capacitance Calculator. No. 37-960...25c
- R-F Resonance and Coil Winding Calculator. No. 37-955...25c

ALLIED RADIO

ALLIED RADIO CORP.
833 W. Jackson Blvd., Dept. 7-M-7
Chicago 7, Ill.

FREE CATALOG

- Rush FREE 164-page Catalog
 - Send Kit No. 83-275
 - Send 6 Books No. 37-799
 - Send Calculators checked above
- } \$.....enclosed

Name.....
Address.....
City.....Zone.....State.....

IMMEDIATE DELIVERY!

Complete as shown

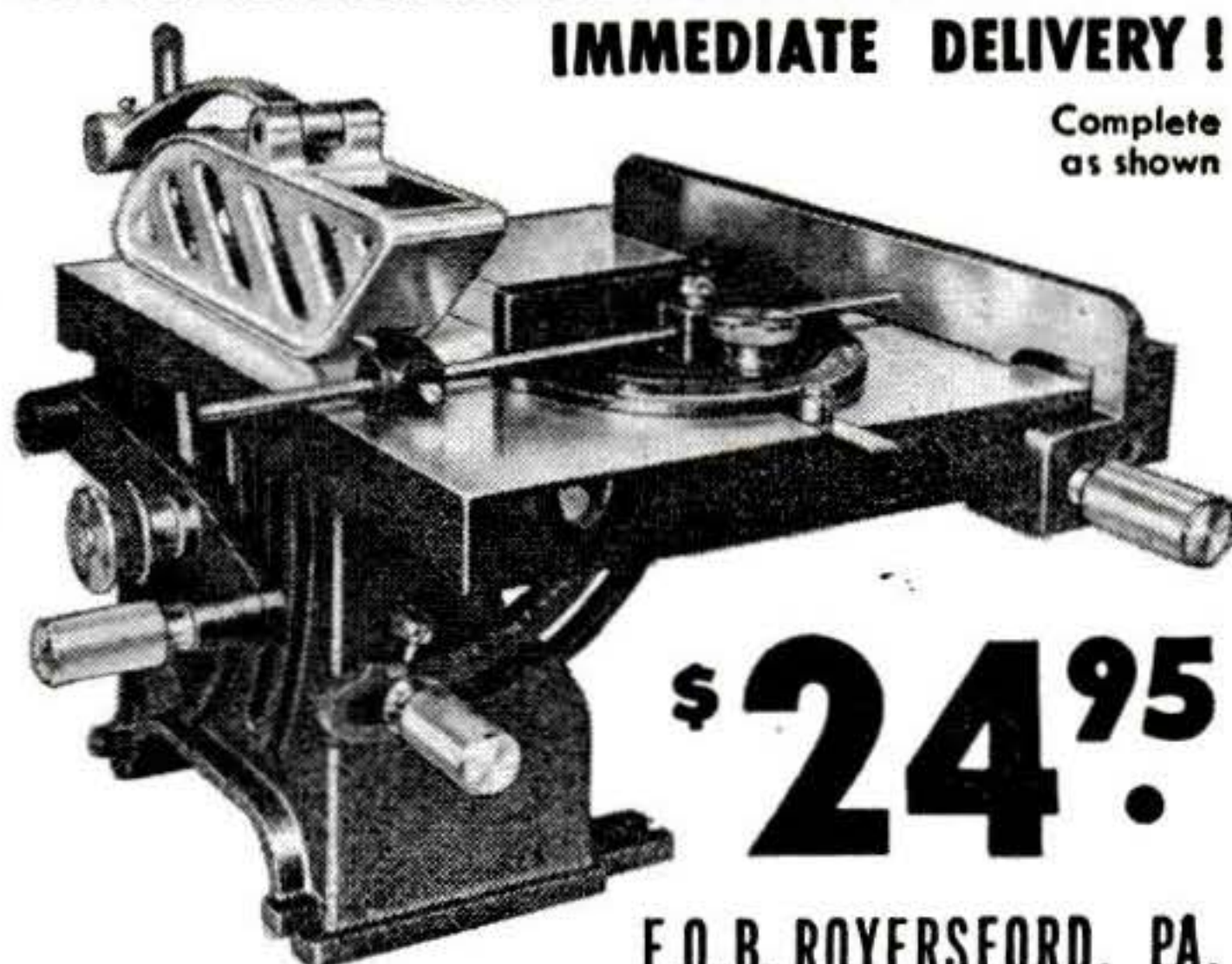

\$24.95

F.O.B. ROYERSFORD, PA.

QUALITY 8" BENCH SAW
CUTS THROUGH 2⁵/₁₆"

UNCONDITIONALLY GUARANTEED ONE YEAR
(Write for Free Booklet and Guarantee Bond)

Comes complete with Floating motor mount—miter gauge with adjustable stop—aluminum guard—soft aluminum insert—spring steel splitter—heavy gray iron fence—(no motor—no blade). Table 12" x 14". Tilts to 45°—Oilite bearings. Shipping Wt. 50 lbs.

AMERICAN MACHINE & TOOL CO. Inc.
DEPT. 200 ROYERSFORD, PA.

148 PAGE WOODWORKERS CATALOG

ONLY 15 CENTS-REBATED ON FIRST ORDER

SHOWS IN NATURAL COLOR
22 inlay and overlay insets
32 veneer bandings—matched woods
30 kinds of world's finest woods in character grains and color
31 mouldings, rosettes, ornaments and home wood working labor-saving tools and hard-to-find hardware.

CRAFTSMAN WOOD SERVICE CO.
2729 S. Mary St., Dept. B-88, Chicago 8, Ill.

LISTS OVER 300 PIECES OF ARTISTIC FURNITURE SHOWN including cost of plans, lumber, hardware and finishing material. Choice of MAHOGANY, WALNUT, BIRCH or MAPLE LUMBER—PLYWOOD—VENEERS. UN-EQUALLED BARGAINS.

Make beautiful furniture at only 20% store prices.

LAW
STUDY AT HOME for PERSONAL SUCCESS and LARGER EARNINGS. 39 years expert instruction—over 108,000 students enrolled. LL.B. Degree awarded. All texts furnished. Easy payments. G.I. Approved. Send for FREE BOOK.

AMERICAN EXTENSION SCHOOL OF LAW
Dept. 84-S, 646 N. Michigan Ave., Chicago 11, Ill.

BROKEN JEWELRY WANTED

All kinds. Highest prices paid for jewelry, rings, spectacles, gold teeth, diamonds, broken and usable watches, etc. Cash mailed promptly. Write for FREE shipping container.
LOWE'S, Dept. PS, Holland Bldg., St. Louis 1, Missouri

Get A SEAMAN ROTARY TILLER
Better Yields—Better Crops



Because this farm-size rotary tiller prepares seedbeds most ideally suited to your soil and crop conditions, it helps produce *higher yields* and *better quality* crops. Can be adjusted for fine pulverization, coarse or medium tillage... just the way you want it. Mixes fertilizer and humus into the GROWING AREA of seedbed; aerates soil; eliminates air pockets and hard plow soles; conserves moisture; promotes earlier and more complete germination of seed; helps to destroy many crop pests and certain varieties of fungus; provides effective weed control; reduces erosion... all with ONE machine!



SEAMAN ROTARY TILLERS are available in power take-off and motorized models 3 to 7 ft. tillage widths. See your Seaman dealer and write for complete information.

SEAMAN MOTORS, Inc. 365 N. 25th Street Milwaukee 3, Wis.



Blade guide aids close following of a line or pattern.



Steel universal chuck holds all blades, files, and sanding attachments.

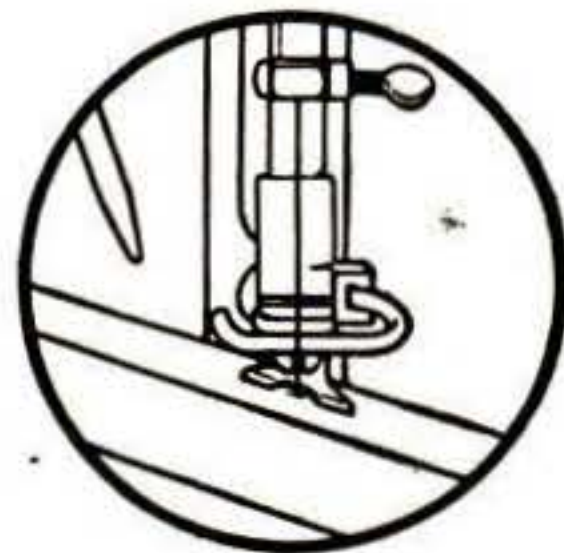

Because spring hold-down tilts with table to hold work firmly, you enjoy smooth operation always.



V-jaws of universal chuck hold files with 1/8" or 1/4" shanks.



Using sanding attachment, you finish exterior and interior surfaces easily.

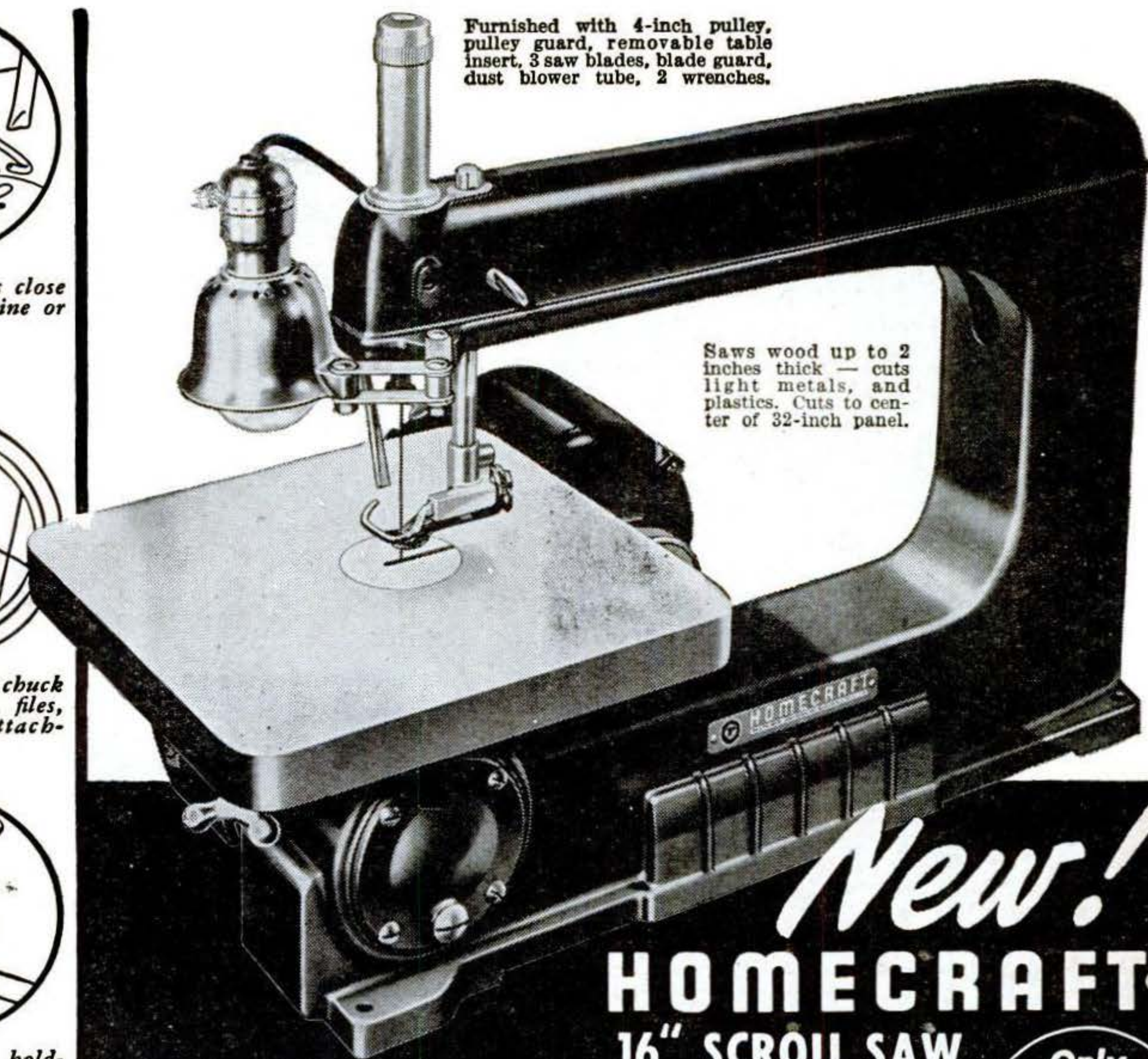

Furnished with 4-inch pulley, pulley guard, removable table insert, 3 saw blades, blade guard, dust blower tube, 2 wrenches.

Saws wood up to 2 inches thick — cuts light metals, and plastics. Cuts to center of 32-inch panel.

New!
HOMECRAFT®
16" SCROLL SAW
built expressly for the hobbyist

Only \$29.95
 (Less lamp attachment and motor)

It's now available at your dealer's store, at surprisingly low cost — this good-looking Homecraft 16" Scroll Saw.

With its speed of 1275 cutting strokes per minute, you can do fast, accurate scroll-sawing of all types: fret work, inlay work and marquetry, jig saw puzzles, etc.

Made by a Leading Tool Builder!

Behind the Homecraft 16" Scroll Saw is the engineering skill of the men who make Delta Power Tools. In schools and factories, as well as home shops, Delta tools have long been recognized as outstanding for safety, accuracy, and dependability.

Having a home shop equipped with Delta Power Tools some day is the dream of practically every craftsman who wants the very best!

Worthwhile Features!

With the Homecraft 16" Scroll Saw, Delta



Catalog Sheets!— Show all Homecraft Power Tools and accessories. Sent to you free. Use coupon, for your copies.

answers the demand for a good, popular-priced tool that is adequate for the average limit-

ed needs of the hobbyist who "putters around" with woodworking.

Delta engineers have included features that make it a real value for the money — a tool you've every right to be proud to own:

Bearings are constantly lubricated from the splash system in the crankcase. . . . Universal blade chuck fits all types of blades, files, and sanding attachments. . . . Pump in head supplies continuous air flow, to keep cutting line free from sawdust. . . . 11" x 11" table tilts 45 degrees to the right and 15 degrees to the left, for angle-cutting. . . . Guides are fully adjustable. . . . Upper and lower chucks rotate 90 degrees, for unlimited-length side cuts. . . . Accurately-machined one-piece casting forms base and arm. . . . Pulley guard provides safety.

See It At Your Dealer!

Ask your Homecraft dealer to show this scroll saw, and his complete display of Homecraft Power Tools that range in price from \$29.95 to \$39.95.

Visit your Homecraft dealer now!



General Sales Office • Chicago 2, Illinois

Tear out coupon and mail today!

DELTA MANUFACTURING DIVISION
 Rockwell Manufacturing Company
 682N E. Vienna Ave., Milwaukee 1, Wis.
 Please send free catalog sheets on Homecraft Power Tools.

Name.....
 Address.....
 City..... () State.....

a Bigger Income
for You

Be Independent!
Start your own ARC
WELDING business



Hobart arc welders

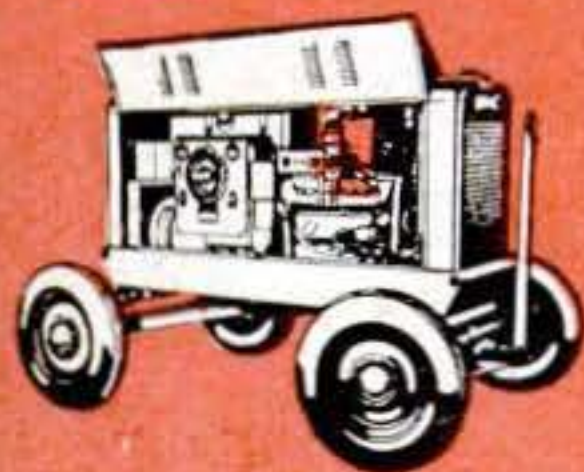

..... make welding better
and more profitable

They're Simplified . . . to give you wide-range current control for superior welding on all sizes and types of jobs. You save time and money with a HOBART Welder.

Small Investment . . . makes it easy for you to start your own business. HOBART Arc Welders are available for every type of work, pay for themselves in no time at all.

"Build Your Own" road type welder . . . using a HOBART Multi-Range Generator and a reconditioned auto engine for the big pay jobs in the field. Save \$300-\$500. Ask us for FREE book also.

HOBART a c Type . . . for single phase 220 Volt lines. Costs you less, yet lets you in on the big profit possibilities of arc welding.

HOBART Arc Welding School—modern building with latest welding equipment and experienced instructors. Operates under G. I. Bill.

Hobart Brothers Company
BOX P-127, TROY, OHIO

Hobart "One of the
World's Largest Builders of Arc Welders"

Ask for the new catalog on HO-
BART Arc Welders

Free!

HOBART BROTHERS CO., BOX P-127, TROY, OHIO

YES, I'm interested in how HOBART Arc Welders can start me out in a profitable business of my own, with big earnings. Send me information on items checked below:

- HOBART Electric Drive
- Gas Engine Drive
- "Build Your Own" Arc Welder
- HOBART AC Transformer Welder
- FREE BOOK "How to Build Your Own."

NAME _____

ADDRESS _____



Take the sluggishness out of your car . . . save on gas and oil, too, by installing a set of quick-seating Burd "Graf-Flox" Piston Rings!

Two free, handy booklets for car-owners, mailed on request. Just print your name and address in the margin, alongside this ad, clip and mail.



BURD PISTON RING CO., DEPT. PS, ROCKFORD, ILL.

BUILD YOUR OWN TRAILER

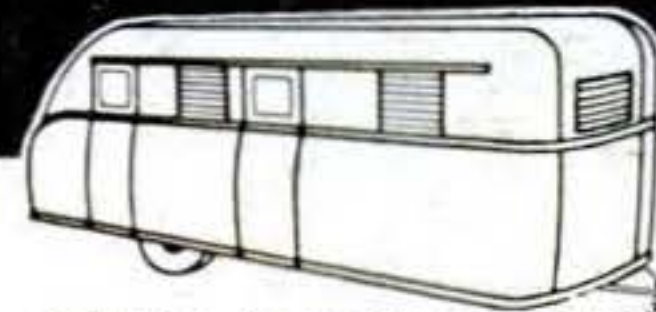

Get these Modern
Complete Plans

Select just the model you want—for hunting—travel—camping—or as a home. Each plan is complete with simple, step-by-step instructions and a bill of materials. Easy to follow. Three models!

STOCK No. H27 NATIONAL MODEL 27. A sleek 27-foot trailer with 3 rooms, lavatory, etc. Sleeps six. complete plan \$1.00

STOCK No. H20 NATIONAL MODEL 20. A good-looking, easily-built 20-ft. trailer. 3 rooms, sleeps four. complete plan \$1.00

STOCK No. H10 NATIONAL CAMPER. A compact unit for traveling, camping, hunting, fishing. Sleeps two. Complete plan .50

Special—Order all 3 of above plans.....\$2.00

FREE! Big parts catalog with any order

NATIONAL TRAILER STORES

Dept. 9 Box 2353 Terminal Annex — Los Angeles 54, Calif.

ONE-MAN SAWMILL LESS THAN \$200⁰⁰

Easy To Turn Trees Into Money

Makes Lumber
ties, shingles,
crates, lath,
studding,
siding.



BELSAW MODELS

in 10 to 24 foot saw-
ing lengths. MECHANICAL FEED,
accurate set works and positive
dogs. Use tractor or old auto engine for
low cost power. Thousands used for com-
mercial sawing. Pays for itself quickly. Send
post card today for FREE booklet, "How To Make
Lumber" and Catalog of Woodworking Equipment.

BELSAW MACHINERY COMPANY

2846G Field Bldg., 315 Westport Rd., Kansas City 2, Mo.

AMERICA'S LOWEST PRICED BAND SAW



ENGINEERING FEATURES
FOUND ONLY IN
HIGHEST PRICED MACHINES

Now
\$16⁹⁵

Practical, modern design; new im-
proved model. Accurate, smooth
operation. Cuts to center of
large 14" circle, 2 1/2" thick.
Genuine "Oillite" bearings
adjustable ball-bearing blade guide. Upper
wheel blade-tension adjustment; safe, fully
enclosed mechanism. Thoroughly proved construc-
tion, ruggedly designed with sturdy laminated
plywood. Stands 24" overall. As illustrated—blade
included. **Immediate Delivery!** See your dealer or
send only \$16.95, plus 50c for postage and hand-
ling. **Guaranteed**—if not satisfied upon receipt of
band saw, return immediately for full refund.
SEE YOUR DEALER or write Dept. 104

SERRO MFG. CO. 1933 Olive St.
St. Louis 3, Mo.

NOW! A FINE TARGET PISTOL EVERYONE CAN AFFORD TO OWN AND SHOOT!



"POWER without POWDER"

THE NEW .177 CAL.

Crosman "Bullseye"

Now ... from the makers of the famous Crosman *Silent Rifle*, comes the new Crosman "Bullseye" ... a single-shot pistol of regulation target type and weight, with the design, quality construction, balance and deadly accuracy demanded by experts. Compare it for performance and thrills. You'll find the Crosman "Bullseye" the outstanding value in small arms today.

SEE YOUR DEALER OR WRITE

• Using Crosman *Super-Pells*, the better ammunition for all air-powered pistols and rifles, you can shoot the Crosman "Bullseye" for ONLY 1/4c PER SHOT!

CROSMAN ARMS CO., INC.
DEPT. 9E, ROCHESTER 7, N. Y.

ASK TO SEE CROSMAN DODO AND BELL TARGETS

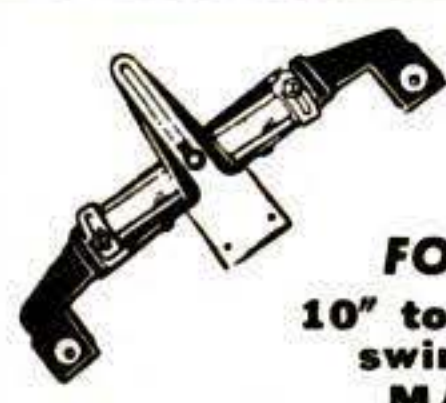

Quick Shipment on TAPER ATTACHMENTS

FOR ALL LATHES OLD OR NEW—
10" to 24" \$49.50 to \$125.00 Write for
swing bulletin

MASTER-TAPER COMPANY
126 N. Clinton St. Chicago 6, Ill.
Exclusive Mfrs. of Taper Attachments



BRASS

For Home Work Shops
Free Cutting Brass Rods
Round, Hex, Sq., 1/2-Oval
Naval Brass Rods
Round and Hexagon
Brass and Copper Tubing
Brass Sheet

Please Send 10c
for Catalog 102

MEIER BRASS & COPPER CO.
1155 Bellevue, Detroit 7, Mich.

A PROFESSIONAL ENLARGER AT 1/2 USUAL PRICE!



THE MINILITE ENLARGER

Diffusion type system with hand ground discs
Fully guaranteed Professional Enlarger. Body of aluminum alloy castings. Includes rotating glassless negative carrier to enlarge up to 2 1/4 x 3 1/4" neg. Tilts from vertical to full horizontal. Rack-and-pinion focusing with extra large knobs. PRICE, less bulb and lens only \$29.95 plus \$3.75 tax. Now selling for less than 1/2 regular price by assembling yourself (all you need is a screwdriver). Simple step-by-step instructions and diagrams. Use your camera lens or f4.5 or f6.3 lens—mount on workshop bench or own baseboard. SEND NO MONEY—Pay postman \$33.70 plus postage (weight 6 lbs.) or send money order and we pay postage. Free Folder on request.

FULLY GUARANTEED ONLY
\$29⁹⁵

CALIFORNIA TECHNICAL PRODUCTS CO.
8510 WARNER DRIVE • DEPT. 112 CULVER CITY, CALIF.

YOU ASSEMBLE • SAVE \$30

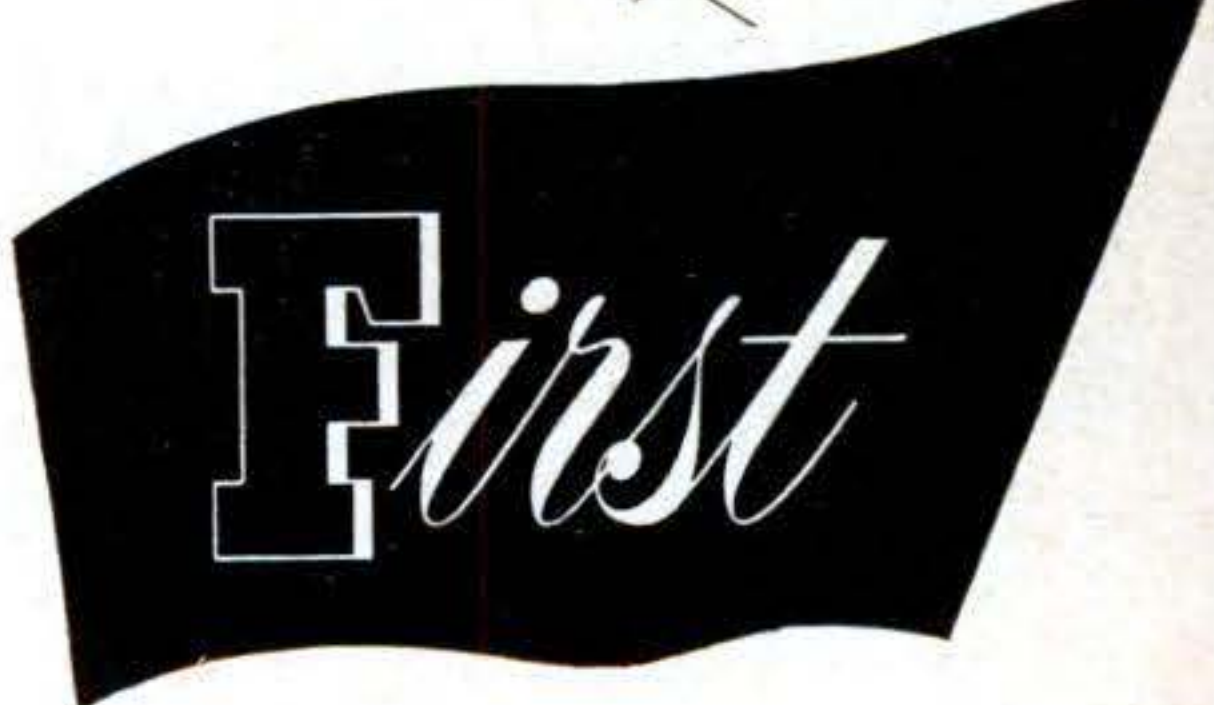

in Original Factory-Equipment Choice

More than 50% of all cars and trucks built during the past 10 production years have been factory-equipped with AC Spark Plugs. The choice of responsible engineers is your assurance of utmost reliability and top performance.

You can continue to have such reliability and performance by buying AC—the original factory-equipment choice in spark plugs.



FIRST IN SERVICE, TOO

Your AC dealer will check your spark plugs to see that they are of the right Heat Range.



AC SPARK PLUG DIVISION • GENERAL MOTORS CORPORATION

Give USEFUL GIFTS



PLUMB TOOLS

"Boys" from 6 to 96 love good hand tools...to use on the job or around the home. For gifts that men prize highly, choose tools. And select the best—Plomb Prime-Quality Tools. Your Plomb Dealer has a complete line in a wide range of prices. See him today. Write for catalog to

PLUMB TOOL COMPANY
2257M Santa Fe Avenue
Los Angeles 54, Calif.

4769



PLUMB
Prime Quality
TOOLS

IDEAL CHRISTMAS GIFT
Set 9900C with three handy tools in leather kit.



"I've pensioned off my reindeer to ride a **WHIZZER**, too, a Merry **WHIZZER** Christmas to every one of you!"

Complete with all necessary attachments. Fits any man's balloon tire bike. If no Whizzer Dealer in your community yet, send to Whizzer Motor Co., Pontiac, Mich., Dept. 5312, for your Christmas Whizzer. **Ride one and you'll buy one!**

\$97.55

plus tax,
F. O. B. Pontiac,
Mich.

WHIZZER
AMERICA'S FINEST BIKE MOTOR

Everything in Radio!

Make Radolek your buying headquarters for Radio-Electronic repair and replacement needs. Large stocks assure finest, most complete selections of all available items at lowest prices. Your orders receive special attention for fastest delivery. Send today for FREE Radolek Buying Guide.

RADOLEK CO., Dept. A-127, 601 W. Randolph St., Chicago 6, Ill.



FREE RADIO BUYING GUIDE

BUILD YOUR OWN MACHINE TOOLS!

Blueprints \$1.00 - Catalog FREE

Make your own Milling Machines, Shapers, Drill Presses, 8" Circular Saws, 6" Jointers and similar tools with Lewis ready-to-machine castings. Save up to 80% of finished machine cost. \$1.00 brings complete blueprint specifications for above 6 tools. Catalog describing Lewis line sent free with blueprint order.

LEWIS MACHINE TOOL CO.

P. O. Box 7446, Sta. L, Dept. S, Los Angeles 23, Calif.



First Choice

Hand and power grinders to fit all needs. Sold at leading hardware stores.

LUTHER GRINDER & TOOL CO.
Sheboygan, Wis.

Luther
HAND AND POWER GRINDERS

Est. 1896



MARGIE

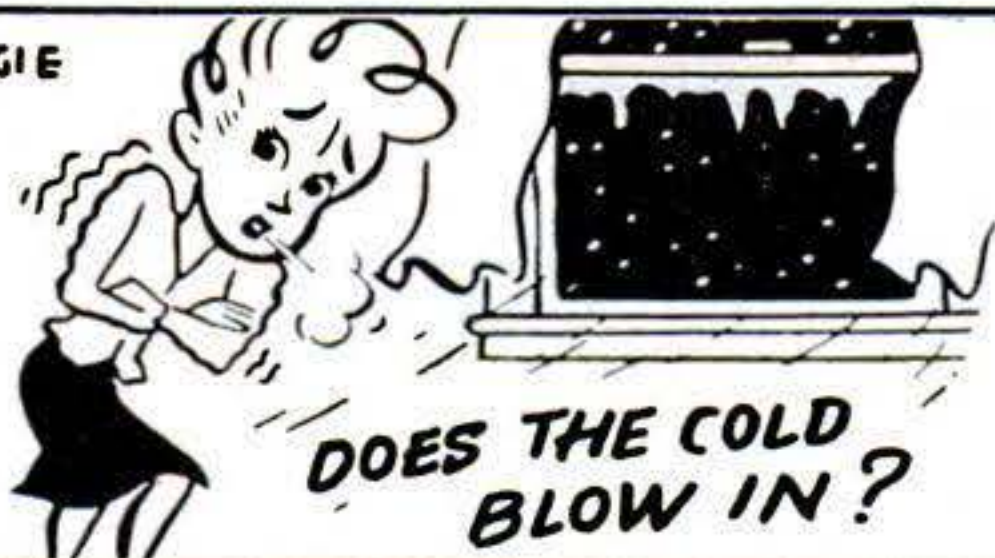

DOES THE COLD BLOW IN?

ITS TIME TO WEATHER-STRIP WITH Mortite



KEEP WARM—SAVE FUEL

Don't put up with dangerous, drafty zones in your home when it's so easy and inexpensive to weatherstrip with Mortite. Simply press pliable Mortite around windows, doors, baseboards, etc. It keeps cold out, keeps heat in, shuts out dust and dirt, too! Mortite adheres to any clean, dry surface. No tools, no tacking needed. Anyone can apply it.

3 Sizes: 29c - 98c - \$1.25



Higher west of the Rockies and Canada.

Get at stores or write for free circular

J. W. MORTELL CO., 534 Burch St., Kankakee, Ill.

WOODWORKERS ... Get this CONSTANTINE MASTER MANUAL

Get the Most Fun From Your Hobby Indispensable to woodworkers. Newest, biggest edition, more pages, more color, helpful how-to-do-it articles, pre-war and new items, more bargains. Send 25c today and we will include FREE! FULL YRS. SUBSCRIPTION to Chips and Chats, published bi-monthly. Keeps you up-to-date on everything in woodworking, offers big money-saving bargains. Send now.



ALBERT CONSTANTINE & SON, Inc. 793-M 135th Street, New York 54, N. Y.

NEW!

HOBBY HANDBOOK

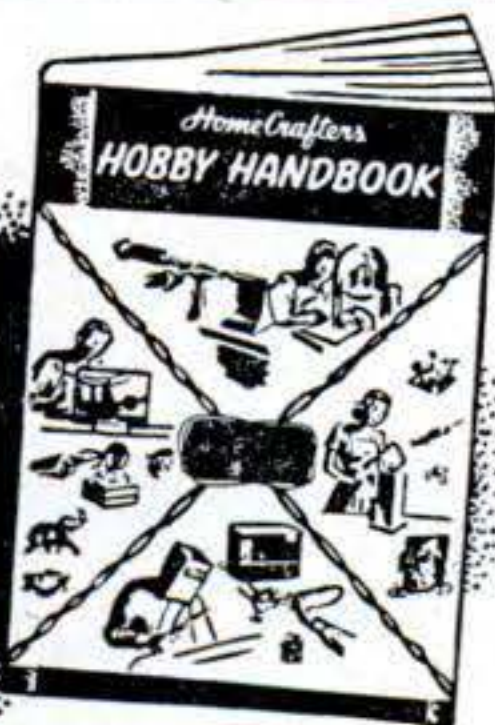

A GOLD MINE of INFORMATION on NEWEST EQUIPMENT, TOOLS for HOME CRAFTSMEN & MECHANICS

If you work in metals, wood, plastics or glass you need this Giant NEW Book of equipment, tools, parts and materials... including dozens of hard-to-get items you can't find in stores. Many things you must have for your home hobby or shop.

- HELPS YOU GET MORE PLEASURE, MORE PROFIT in
- HOME CRAFTS
 - METAL CRAFTS
 - WOODWORKING
 - PLASTIC CRAFTS
 - HOME REPAIRS

A WAREHOUSE OF THINGS YOU NEED AND WANT

Over 100 items including Spray Guns; Power Bench Tools; Lathe; Drill Press; Drills; Grinders; Tank and Brush Electroplaters; Telephone System; Tool Chest; Model Tools; "Pin Money" Makers for your sparetime fun and profit! SEND NAME and ADDRESS and 10c TODAY! Price of Handbook refunded on first order.

WARNER ELECTRIC CO., Dept. P-21 1512 JARVIS AVENUE, CHICAGO 26, ILLINOIS

RIDE YOUR WAY TO GOOD TIMES

ON A HARLEY-DAVIDSON

Every strange road challenges you to new adventures! Every high hill brings you breathtaking new panoramas! Every trip on a Harley-Davidson opens new worlds of pleasure, with jolly companions, new things to do and see! So why not swing into the saddle of your own Harley-Davidson and head down some happy highway to good times... to thrilling "gypsy tours", exciting race meets, hillclimbs, endurance runs, delightful sightseeing expeditions? There's no sport like motorcycling, no fun like owning a Harley-Davidson. "Owning your own" is easier than you may think. See your Harley-Davidson dealer today. Mail the coupon now.

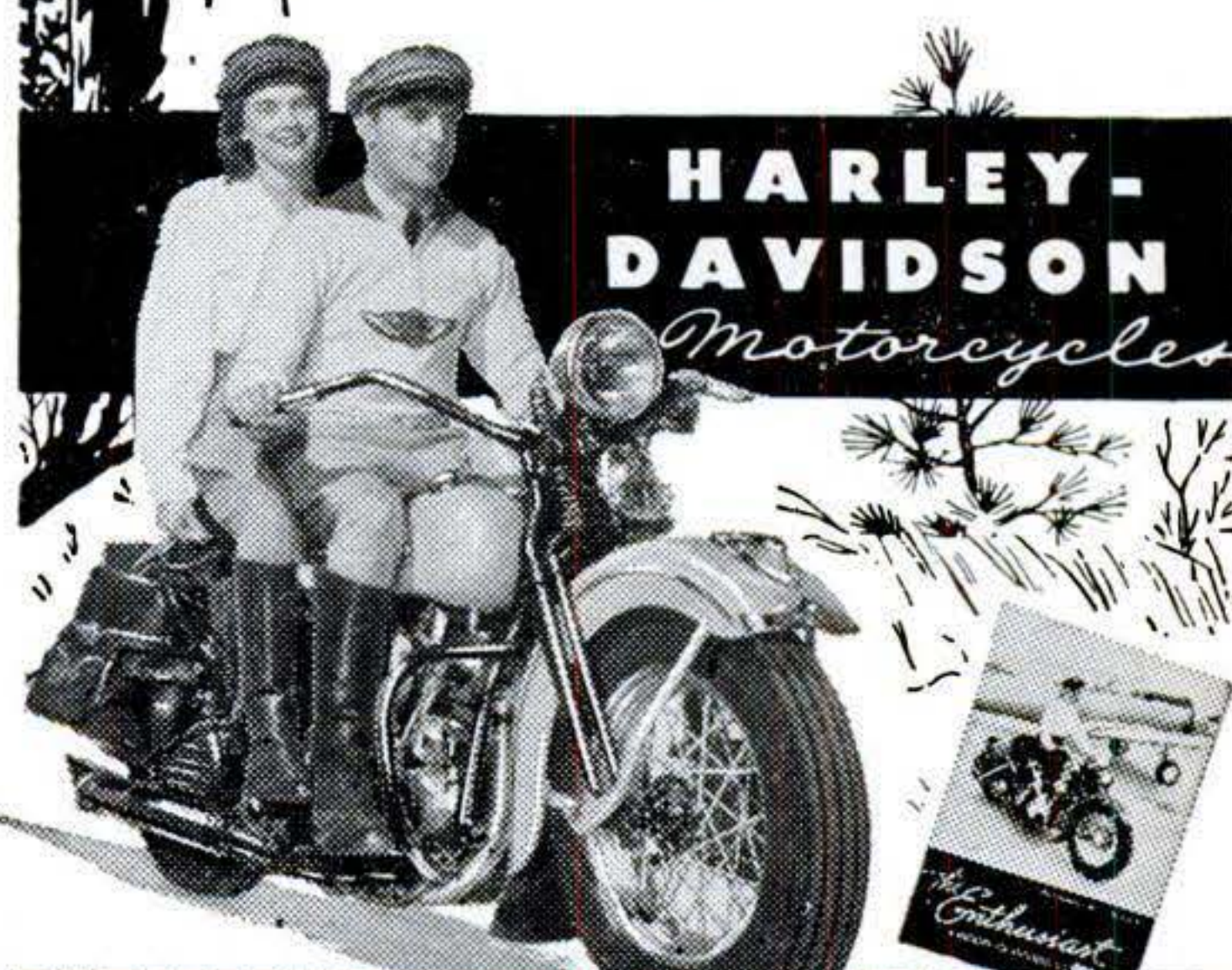

HARLEY-DAVIDSON Motorcycles

HARLEY-DAVIDSON MOTOR CO. Department P5, Milwaukee 1, Wisconsin

Send FREE copy "ENTHUSIAST" Magazine filled with thrilling motorcycle action pictures and stories; also literature on your 1948 models.

Name.....

Address.....

City..... State.....

**UNIQUE SINGLE FRAME
MAKES THIS THE**



**BEST CAMERA
FOR COLOR!**

UNIQUE SINGLE FRAME feature makes the Mercury II especially designed for color . . . and outstanding for black-and-white . . . for it permits the incorporation of the three important factors that camera experts agree are necessary for good color photography.

1. SHARPNESS OF NEGATIVE. Universal engineers discarded the old-fashioned idea of negative size and incorporated into the Mercury the same size 35mm. negative as is used for the projection of motion pictures. By using this single frame size, it was possible to attain a short focal length, which results in an amazing depth of focus at any given aperture, thus assuring sharpness of negative over a much greater area. This extreme depth of focus assures excellent results for color projection or the making of enlarged color prints.

2. SHUTTER ACCURACY. Mercury II's rotary focal plane shutter, with speeds up to 1/1000th, has been proven more accurate by actual test. It is used and endorsed by Harvard Observatory.

3. LENS CORRECTION. Universal's experience in the grinding and polishing of lens and prisms for precision optical instruments resulted in the color corrected anastigmat Mercury II lens.

To cap it all, Mercury II cuts color costs almost in half . . . you get 36 pictures on a standard 20-exposure cartridge. Yes, Mercury II is the only minicamera especially designed for color. That's why we state that Mercury II is "second to none" for natural, vivid, fresh, true-to-life color results. No wonder photo experts are turning to Mercury II for natural color! Look it over at your dealer's today!

MERCURY II—It's a Universal

UNIVERSAL CAMERA CORPORATION
NEW YORK CHICAGO HOLLYWOOD

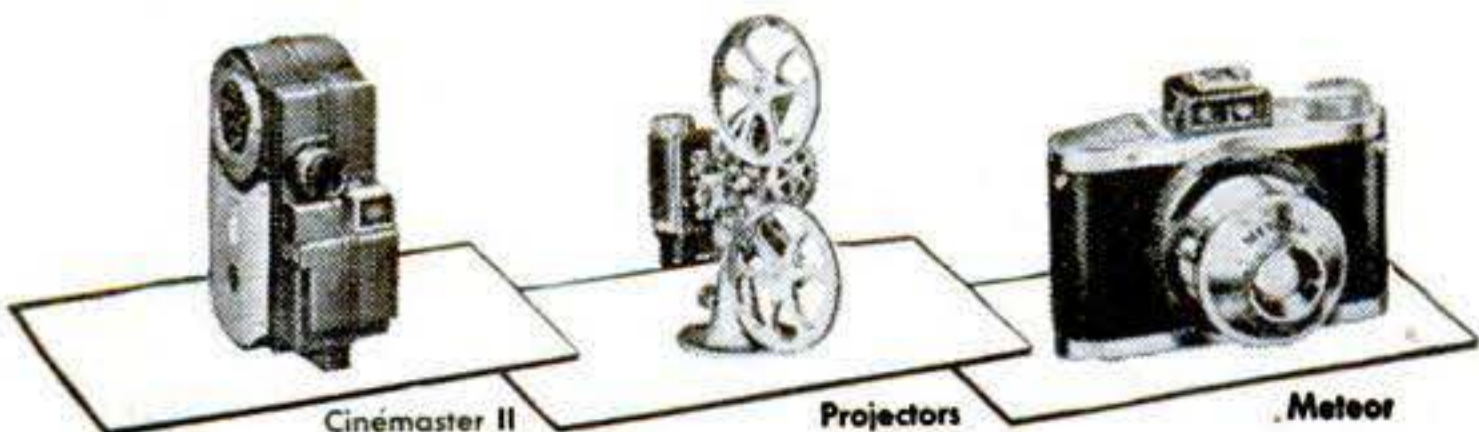

Cinémaster II

Projectors

Meteor

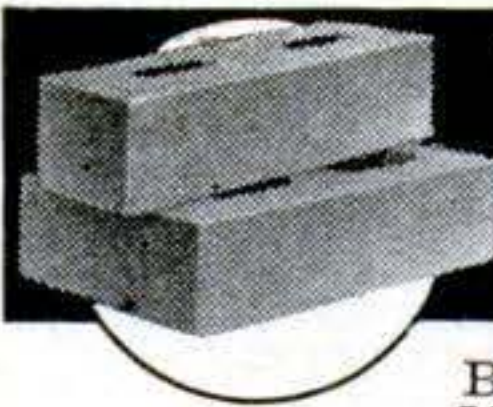

**More Local
Manufacturers
are Needed-NOW**

Brikrete is sweeping the country. More local plants are badly needed. Several hundred territories are being opened up for local Brikrete manufacture by men of vision and aggressiveness. Brikrete ties in with today's huge building program. Makes possible better construction at lower cost. Truly better than brick; actually cheaper than lumber. Combines strength, safety, insulation value, colorful beauty.

World's Most Modern Masonry

Brikrete is made in locally owned plants, using local materials and local labor. That's why high quality and low price still permit a 100% to 150% mark-up. We supply complete equipment; easy terms if required. Generous cooperation. Exclusive manufacturing privileges in protected territory. Write or wire for information.

BRIKRETE ASSOCIATES, INC.
4675 S. Division, Grand Rapids, Mich.

BRIKRETE

HAND REAMER SETS



A Complete Set of 33 Hand Reamers— $\frac{1}{4}$ " to $1\frac{1}{4}$ " by 32nds—All in a Well-Built Oak Box!

REGULAR \$90.00 VALUE!

OUR PRICE—

\$30.00

GUARANTEED!

Send for Our Complete Catalog of Machine Shop Tools and Equipment—Only 40c—Refunded on First Order over \$10.00.

VETERAN TOOL & SUPPLY CO.

88 Baxter St.

New York 13, N. Y.



**A GIFT SUGGESTION TO FOLLOW
FAMOUS HULL COMPASSES**

FOR CAR OWNERS (ILLUMINATED)

\$5.95



FOR CAR OWNERS (STANDARD)

\$3.95

FOR BOAT OWNERS

\$2.75



HULL MFG. CO., P. O. Box 246-E11, Warren, Ohio

HOLD-E-ZEE

**AUTOMATIC GRIP
SCREW-DRIVERS**

**UNSURPASSED
QUALITY**

Plus the

EXCLUSIVE GRIPPER

Pat'd
Gripper slides up out of way when not in use. Insulating handles. Complete range of sizes. AT LEADING DEALERS EVERYWHERE

UPSON BROS., INC., 86 EXCHANGE ST., ROCHESTER 4, N. Y.

Speed Way

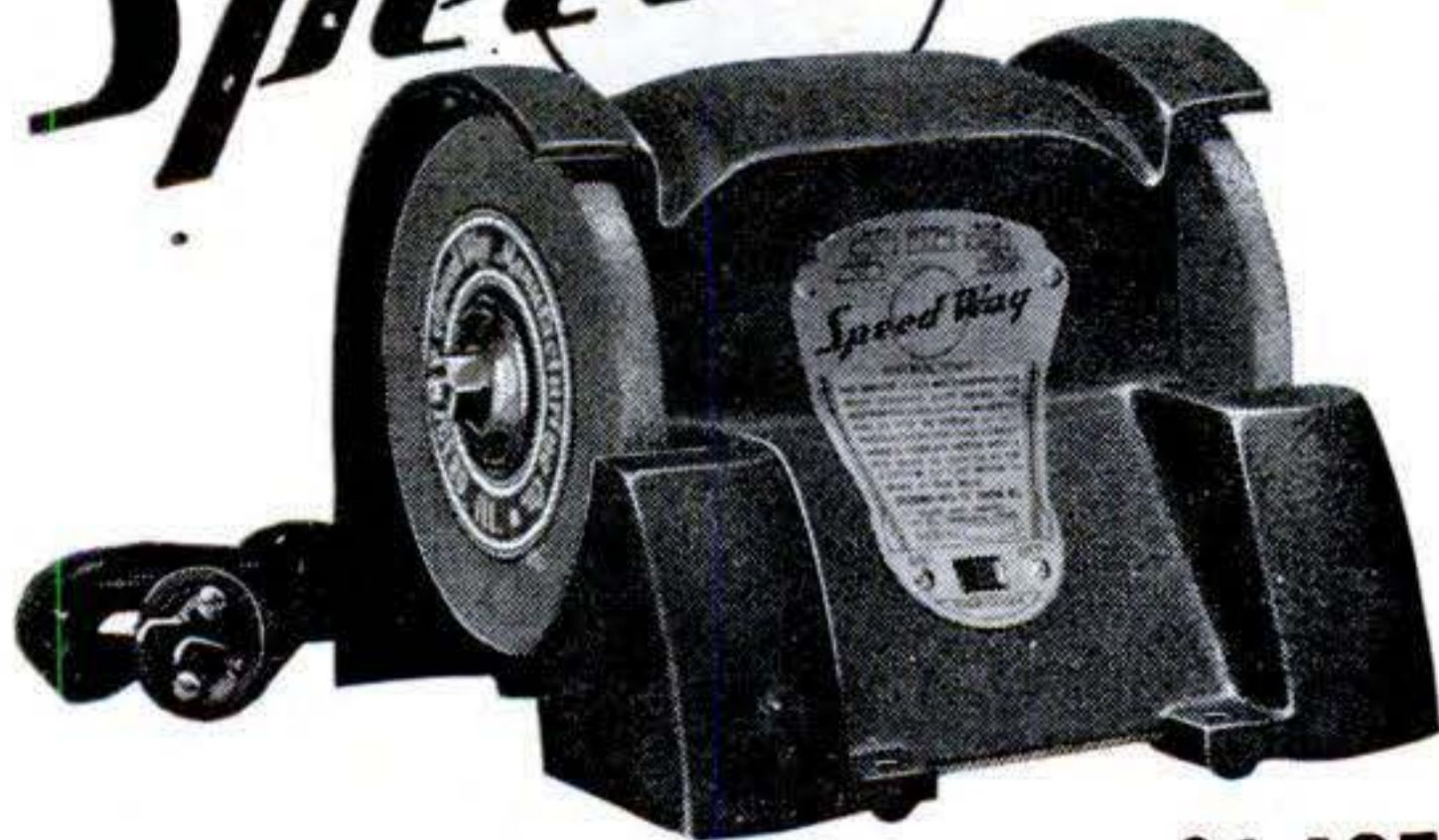

No. 117 portable bench grinder **\$14⁹⁵**

Light, handy, efficient for workshop, garage or factory. Self-contained grinder with 1 fine and 1 coarse (4 1/2" x 3/8") grinding wheels. New powerful shaded pole motor operates at correct speed. Self-aligning bearings, 1-piece cast aluminum housing has integral wheel guards, tool rests and switch. Plugs into any 110-120 A.C. circuit. No. 69 Electric Drill, drills holes up to 1/4" in steel. Die-cast, pistol-grip makes it natural to drill straight holes. Has specially wound high torque tool motor, only \$11.80.

Ask your dealer to show you the complete line of SpeedWay Blue Line Portable Electric Tools.

No. 69
1/4" Drill **\$11⁸⁰**



SPEEDWAY MANUFACTURING CO.
1864 S. 52nd Ave., Cicero, Ill.

COMPLETE LINE

WALKER-TURNER

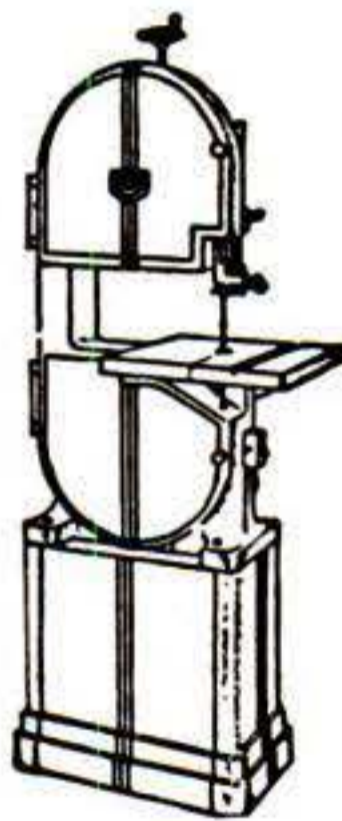

Drill Presses, Saw Tables, Lathes, Band Saws, Jointers, Radial Saws, Sanders, and many other Machines—large and small. Immediate delivery! We invite your inquiries.

Send for **FREE** Catalog "B"

CARPENTERS MACHY. CO.

213 N. 11th St., Philadelphia 7, Pa.

War Surplus BARGAINS

Make repairs on your farm, home or shop with these special values

TOOL KIT—Just what you need. Consists of 18 tools: screwdriver, punch, monkey wrench, chisels, wrenches, files, crate opener, hammer, pliers, saw, saw blades, mallet, plane, "C" clamp, etc. This handy kit, with tool box, only **\$7.75**

HARDWARE UNIT—for building and repairing. 18 items include cotter pins, hooks, nails, screws, scotch tape, emery cloth, rubber tape, grease, liquid cement, nuts, padlocks, hinges, putty, washers, wire, etc., all for only **\$5.65**

50% payment with order balance C. O. D. plus Parcel Post
Ask for our **FREE** War Surplus Bargain Catalogue of other hard-to-get merchandise offered at low prices.

CENTRAL STEEL SUPPLY CO.
294 Washington St., War Surplus Dept. E
Boston 8, Mass.

FOR Building AND Repairing CHRISTMAS TOYS



use **PLASTIC WOOD**

You can get a professional finish on those jobs for the kids! For a slick, smooth finish that takes paint, lacquer or varnish perfectly, use Plastic Wood as your filler. Repairs such as cracks, gouges or loose joints are quickly mended and the toy is back in apple-pie order! *Handles like putty—hardens into wood!*

... dozens of other uses

FOR FILLING ... FOR REPAIRING ..

- Countersunk screws
- Loose casters
- Chipped furniture
- Broken balusters
- Nail and screw holes
- Broken furniture

- You'll want Plastic Wood SOLVENT, too. Get both at one time. It is made especially to control the consistency of Plastic Wood ... useful also in removing dried Plastic Wood from tools and fingers.

T. M. Reg. U. S. Pat. Off.

At all Hardware, Paint and 10c Stores

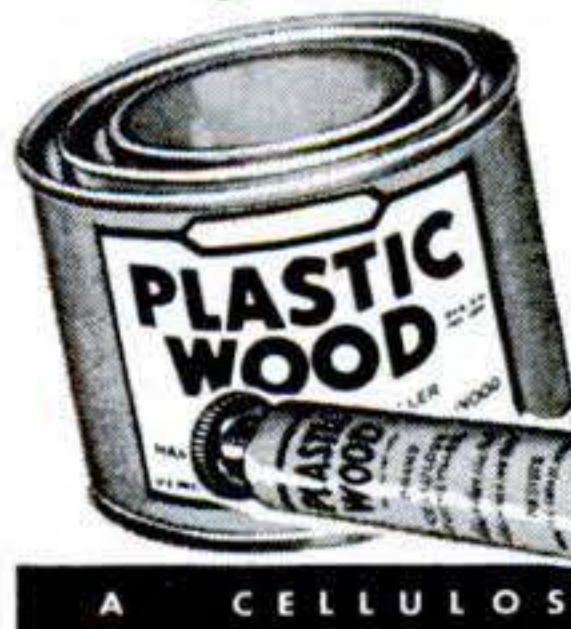

PLASTIC WOOD

Tube or Can

A CELLULOSE FIBRE FILLER

DISSTON

The saw most carpenters use

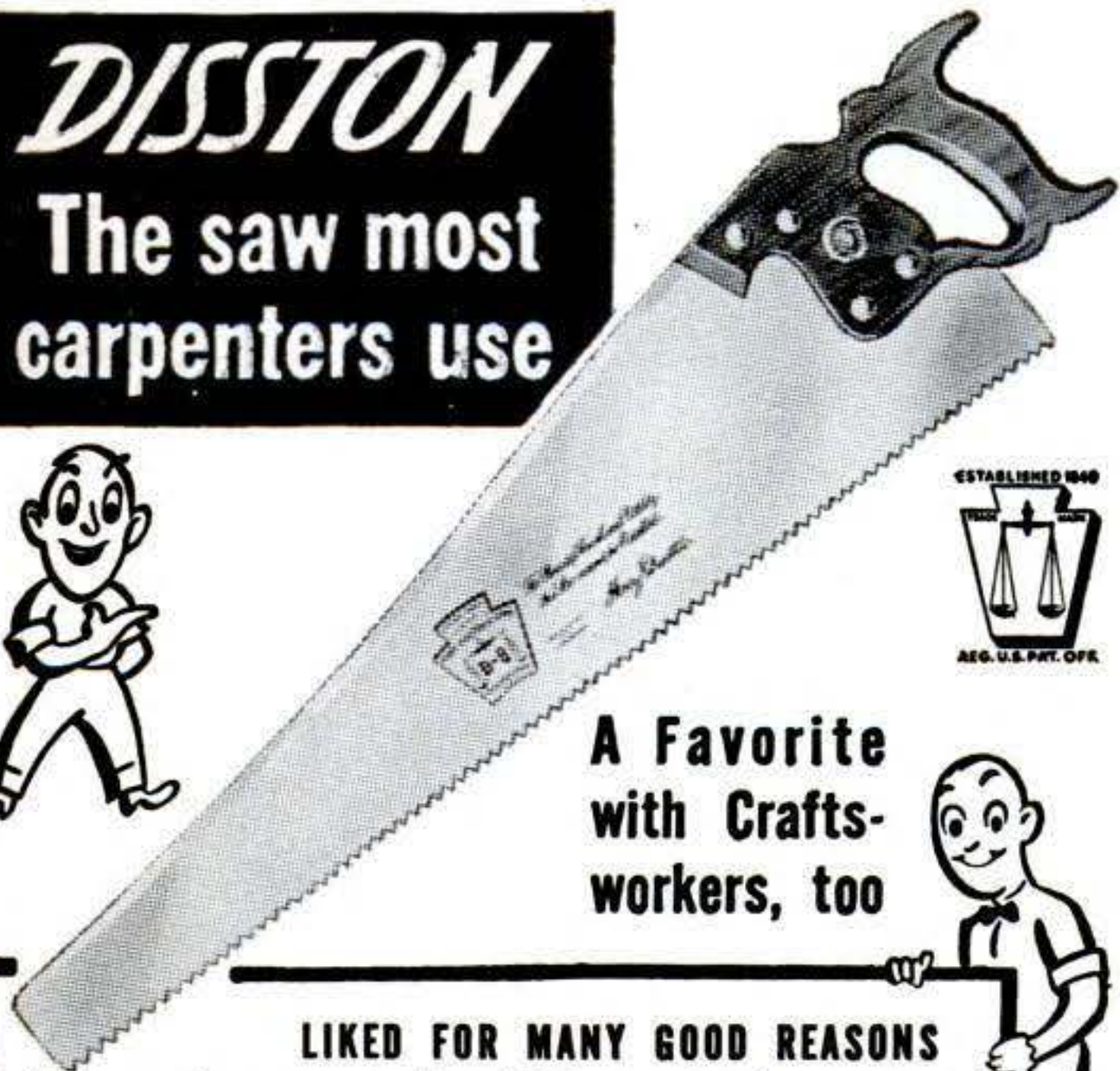

A Favorite with Craftworkers, too



LIKED FOR MANY GOOD REASONS

Disston Saws are made of Disston Steel to assure highest quality and uniformity. True taper ground for faster, easier sawing. Being scientifically hardened and tempered throughout, they require less frequent setting and filing, stay sharp longer... last longer, too. Disston makes a complete line of...

SAWS FOR EVERY HOME WORKSHOP NEED

Ask your Hardware Retailer for Disston Hand Saws and Back Saws, Compass and Coping Saws, Band and Circular Saws. All are described in the Disston Saw, Tool and File Manual, which contains valuable home workshop data. Write for a FREE Copy.

HENRY DISSTON & SONS, INC.
1210 Tacony, Philadelphia 35, Pa., U.S.A.



PAINTERS' STRIPING TOOL

A TOOL... NOT A BRUSH

NEW, IMPROVED

Modern—streamlined—fits the hand like a fountain pen! Easy to use as a pencil. Draws parallel lines—straight, curve or circular. Does expert job on autos, furniture, toys, bikes, model planes, signs, bulletins, linoleum. (Makes wall board look like tile.) Every painter and craftsman needs one! Type "M" MASTER Painters' Striping Tool complete with tip for 1/16" stripe, \$1.00. Extra tips 1/64", 1/32", 3/64", 1/16", 5/64", 3/32", 1/8"—75c each. Tool with complete set of 7 tips \$5.00. (C.O.D. orders 25c extra.) Paint dealers, write!

\$1.00
POST PAID

EASY AS USING A PENCIL!



WENDELL MFG. CO.
4234-A Lincoln Ave., Chicago 18, Illinois



CODE-RECEIVING SPEED

Learn to send and receive Radio Code with greater speed. Stop nervous tension. Have confidence. Be proficient. Same system used by radiotelegraph specialists. Thousands of operators needed. Rush name for FREE book.

CANDLER SYSTEM CO.
Dept. 6-0, Box 928, Denver 1, Colo., U. S. A.

LIQUID MARBLE COLORED POTTERY

Different! Marvelous! Color-glazed. Brush, spray, mold tiles, table-tops, ornaments! **SANITARY COM-POSITION FLOORING**—Dustless, noiseless; put on like plaster. plain or tile designs; yielding as cork, lasting as stone. **RUBBERLASTIC Mold Compound**—For plaster casting, novelties, statuary, toys, plaques, dolls. **TILEX Colored Roofing.** Build Modern **PLASTIC HOMES.** Illustrated literature free.

RAPID MARBLEIZING SERVICE, Dept. 12-A, Edwardsville, Illinois



FREE CATALOG Pins and Rings

Finest quality. Over 300 artistic designs. Write for our attractive free catalog and select a beautiful pin or ring for your class or club. Dept. O, Metal Arts Co., Rochester, N. Y.



DRILL-INDEX

A compact container for indexing and filing twist drills. Eliminates search. Made entirely of steel in ten sizes. See your dealer or write to

HUOT MANUFACTURING CO.
553 N. Wheeler St. Paul 4, Minn.

Say You Saw It In Popular Science

Tired Kidneys Often Bring Sleepless Nights

Doctors say your kidneys contain 15 miles of tiny tubes or filters which help to purify the blood and keep you healthy. When they get tired and don't work right in the daytime, many people have to get up nights. Don't neglect this condition and lose valuable, restful sleep.

When disorder of kidney function permits poisonous matter to remain in your blood, it may also cause nagging backache, rheumatic pains, leg pains, loss of pep and energy, swelling, puffiness under the eyes, headaches and dizziness.

Don't wait! Ask your druggist for Doan's Pills, a stimulant diuretic, used successfully by millions for over 50 years. Doan's give happy relief and will help the 15 miles of kidney tubes flush out poisonous waste from your blood. Get Doan's Pills.

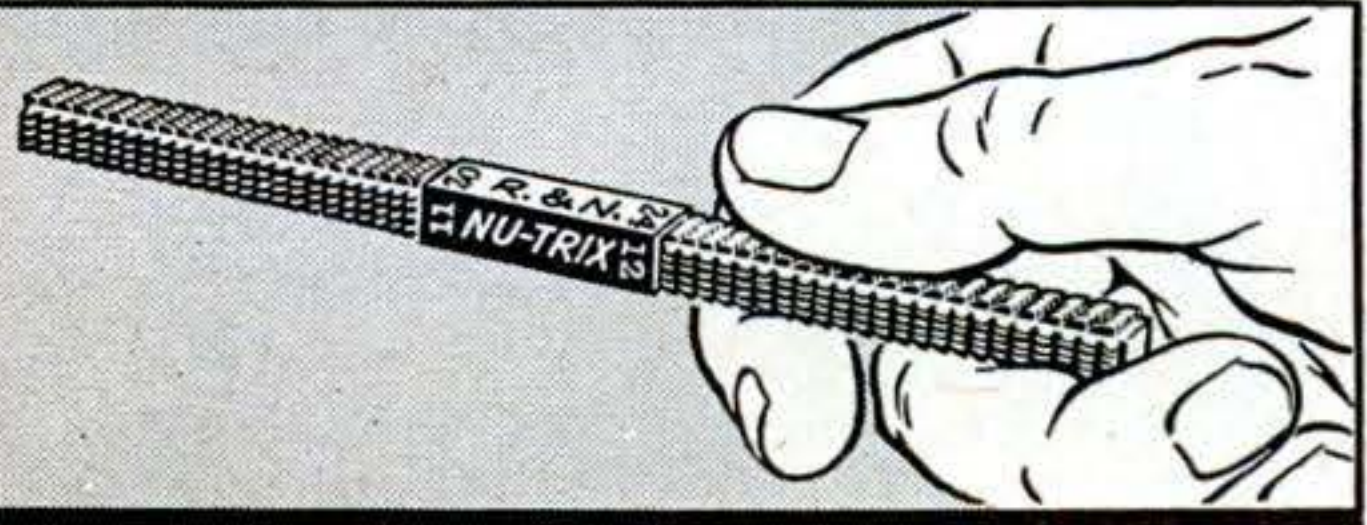

U. S. Pat. No. 1694229

NU-TRIX THREAD RESTORER

Use it Like a File, Fix Battered Threads on Bolts, Shafts or Studs, etc., with a Few Strokes.

A Tool Box necessity—8 Tools in one
No. 1 Nu-Trix for 11, 12, 13, 14, 16, 18, 20, & 24 Thds. per in.
No. 2 Nu-Trix for 9, 10, 15, 16, 20, 26, 28, 32 Thds. per in.

Price 2.00 ea. P.P. Prepaid

REIFF & NESTOR COMPANY Box G
Lykens, Pa., or your local jobber

Enclosed Money Order \$..... or Check please send No. 1 No. 2 Nu-Trix

Name.....

Street.....

City.....Zone.....

**GOOD WEAR FOR WORK
GOOD LOOKS FOR PLAY**



REEVES Army Twill is a double duty fabric that's right for work and play. It's highly resistant to wear and tear, and its wide variety of vat dyed colors are fast to sun, water and perspiration. Being Sanforized*, it can take repeated washings and still come up fresh and new. For better looks and longer wear—demand Reeves Army Twill.

*Residual shrinkage less than 1%

REEVES BROTHERS, INC.
54 Worth Street, New York 13, N. Y.



TOYS COMPLETE PLANS FOR JUST 10¢
STANLEY
PLAN SET No 16

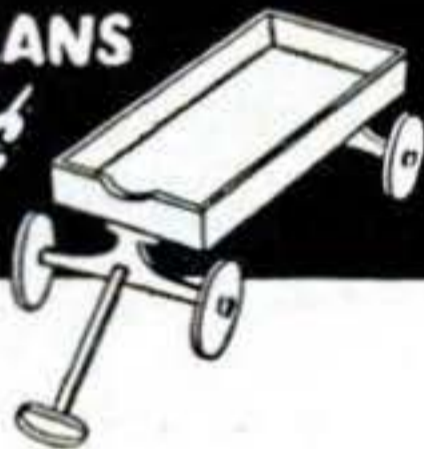

Happy evenings for you . . . joyous days for your children . . . holiday gifts for all. Detailed plans for easy to make, hard to buy toys . . . wheelbarrow, rocking horse,

kiddie push car, scooter and toy wagon. Send just 10¢ and ask for free list of all the Stanley Plan Sets. **STANLEY TOOLS, 2127 Elm St., New Britain, Conn.**

UTICA TOOLS
FOR MORE TOOL MILEAGE



WRENCH No. 91—4"—6"—8"—10"—12"

UTICA DROP FORGE & TOOL CORPORATION
UTICA 4, NEW YORK

STOP WASTEFUL FURNACE LEAKS AND SAVE FUEL

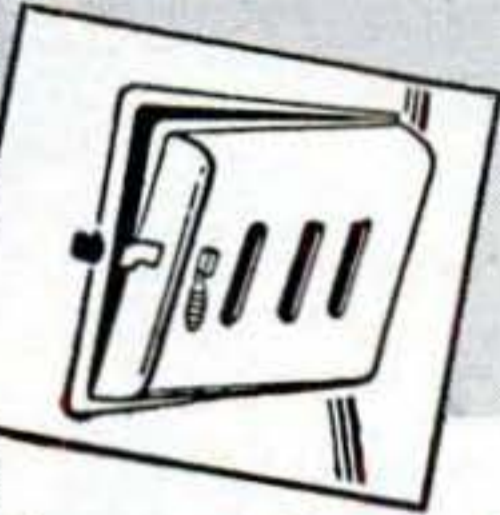

A warped furnace door lets heat escape; build up the frame with Smooth-On No. 1

Use Smooth-On No. 1 to stop draft leaks in heaters

Seal up air leaks in your heating system with Smooth-On No. 1 Iron Cement and your fuel bills will get smaller.

You can apply Smooth-On yourself, like professional repair men have been doing for more than 50 years. You use it like putty — no heat necessary. It hardens like metal and stays tight, because it expands slightly as it sets.

Use Smooth-On to stop leaks and seal cracks in steam, hot water and hot air furnaces, radiators and piping. Tighten loose parts and fixtures with it. Buy Smooth-On No. 1 in economical 1 3/4- or 7-oz. size at your hardware store. If they haven't it, write us.



REPAIR HANDBOOK FREE

40 pages filled with time-saving, money-saving, short-cut repairs on home and shop equipment. Clear, simple directions. 170 illustrations. Thousands of home folks and craftsmen write us for copies each month. Send coupon for YOUR free copy.

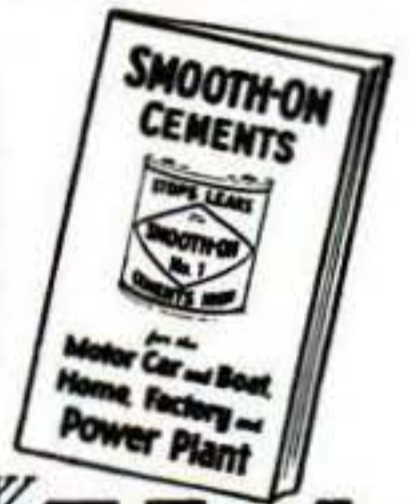

— — — — Sign and Send NOW — — — —

Smooth-On Mfg. Co., Dept. 58M
570 Communipaw Ave., Jersey City 4, N. J.

Please send me my free Smooth-On Handbook

Name

Address

12-47.....

Do it with **SMOOTH-ON**
THE IRON CEMENT OF 1 000 USES

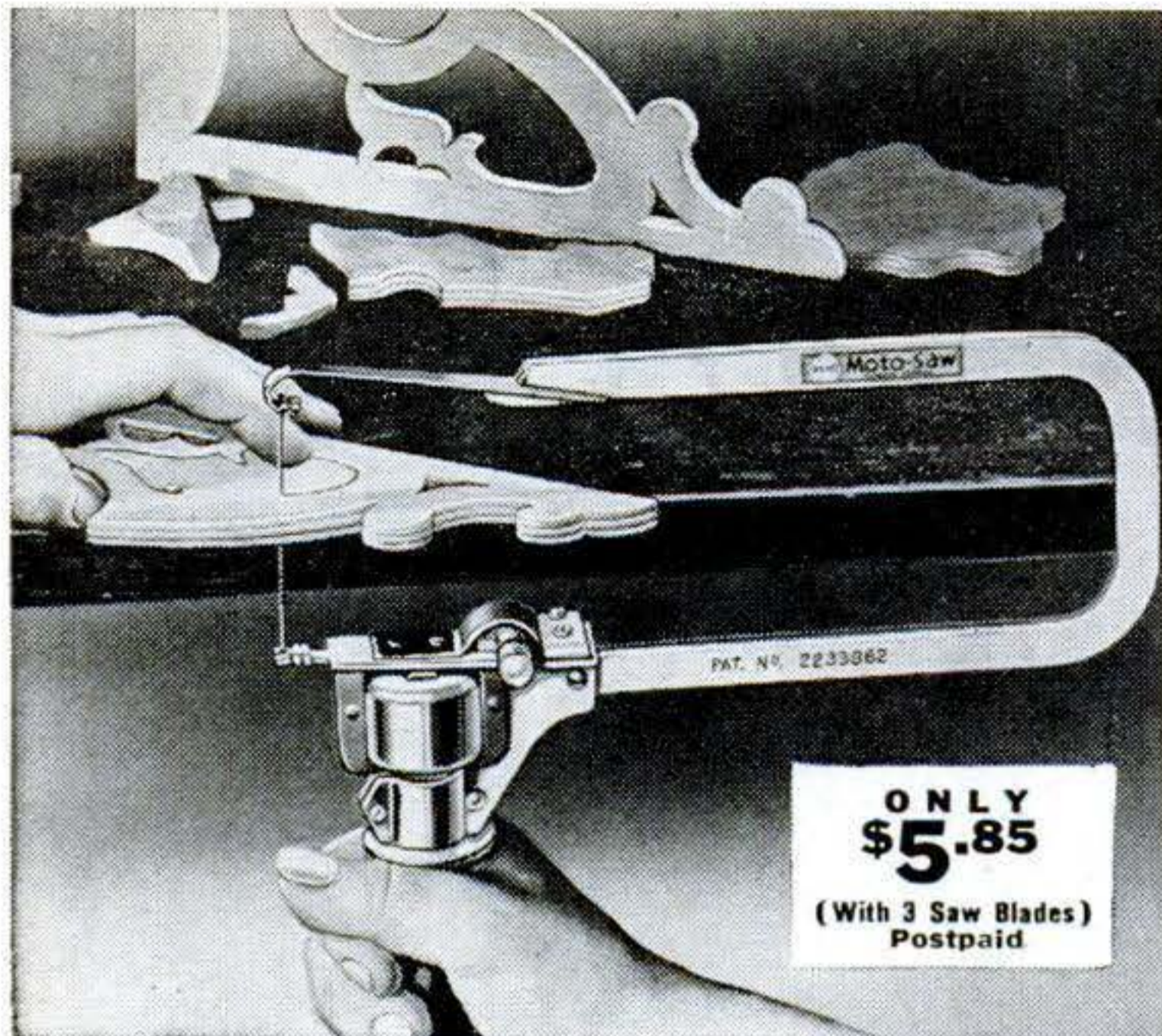

ONLY \$5.85
(With 3 Saw Blades)
Postpaid



MOTO-SAW

THE AMAZING ELECTRIC SCROLL SAW

Boys from 8 to 80 (and girls, too) have fun with a Moto-Saw . . . it works more like magic than any tool you ever saw! It takes no effort to run, no perceptible pressure to feed. Runs 7,200 strokes a minute . . . easily cuts intricate scroll designs in medium hard wood up to 3/4" thick. Blade holder faces blade 4 ways . . . permits you to saw sideways as well as forward and backward. No limit to length of stock it will cut . . . saws to center of 19" widths. **Moto-Saw is as safe as a hand saw . . . has only two moving parts . . . never needs oiling.** Uses 110-120 V. 50 or 60 cycle A.C. (only). Thousands of satisfied users.

MONEY-BACK GUARANTEE: If your dealer does not yet have Moto-Saw, send only \$5.85 . . . we'll pay postage. Or send \$1, and pay postman balance plus postage. Money back if not delighted after 5 days' trial.

DREMEL MFG. CO., DEPT. S127-M, RACINE, WIS.



SEND FOR FREE FOLDER OF LATEST MODELS TODAY
If you want a **REAL GUN** for **PRACTICAL USE** inside or outdoors get a **SAFE - CLEAN - ECONOMICAL - BENJAMIN** with Adjustable Power and Amazing Accuracy. For **BEST RESULTS** use **BENJAMIN H-C PELLETS**. **WRITE AT ONCE**. BENJAMIN AIR RIFLE CO., 811 MARION ST., ST. LOUIS 4, MO.



Ideal Christmas gift! Sprays paint, varnish, lacquer, disinfectants. Paint anything—do it better—five times faster! Generate compressed air, inflate tires, other uses. Delivered (less motor) with sturdy base, compressor, "V" belt, motor pulley, 15 feet high test air hose, trigger-type spray gun, one-quart cup. No. 112—\$26.95.

SPECIAL! No. 444 Master twin-cyl Sprayer (less motor) \$47.50. Handles biggest jobs!

ELECTRIC MOTORS—ball bearing, capacitor, 110/220 V, 1725 rpm, 1/4 HP—\$24.75, 1/2 HP—\$37.50.

IMMEDIATE DELIVERY on above. Add 5% west of Mississippi Prepaid if check or M.O. enclosed. C.O.D. receipt of 25% deposit. Write for **FREE Catalog; Power Tools, Radios, Toys.** Address: Indiana Appliance Co., 20 East Sycamore, Dept. PS-1247, Evansville 9, Ind.



New U. S. Army Air Force B-15 FLYING JACKET

Waterproof Zelan

Alpaca lined body and sleeves, full mouton collar, 2 outside and 2 inside pockets. Wool knit wrist and bottom. Zipper front & pencil pocket on sleeve. Sizes 36 to 46. **\$15.00**

Shipped Insured & Postpaid

I. GOLDBERG & CO., 429 Market St., Phila. 6, Pa.

SEND FOR WINTER CATALOG DEPT. P.S.



RHEUMATISM

ARTHRITIS-NEURITIS-SCIATICA

If you suffer the agonizing pains of these diseases when the usual remedies have failed, learn about a new trustworthy, modern, non-surgical treatment method. This marvelous treatment is completely explained in the Ball Clinic's **FREE Book**. Write today. No obligation. **BALL CLINIC Dept. 36 Excelsior Springs, Mo.**



Print Your Own

Cards, stationery, circulars, tags, labels, photo and movie titles, advertising, etc. Save money. **Print for Others, Good Profit;** easy rules sent. Raised Printing like Engraving, too. Send dime for press samples, supply book, all details and advice on your needs. No obligation. **KELSEY INC., B-33, Meriden, Conn.**

"I'LL TAKE THE WHITE ONE EVERY TIME!"



WYTEFACE
TRADE MARK
STEEL MEASURING TAPES

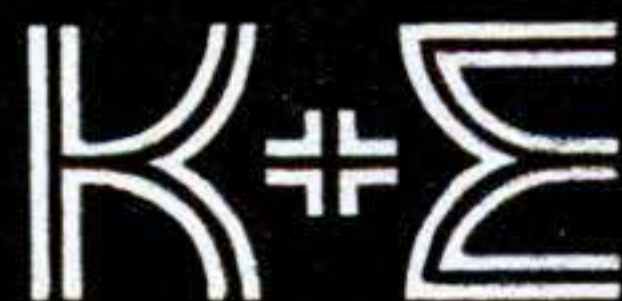

KEUFFEL & ESSER CO.

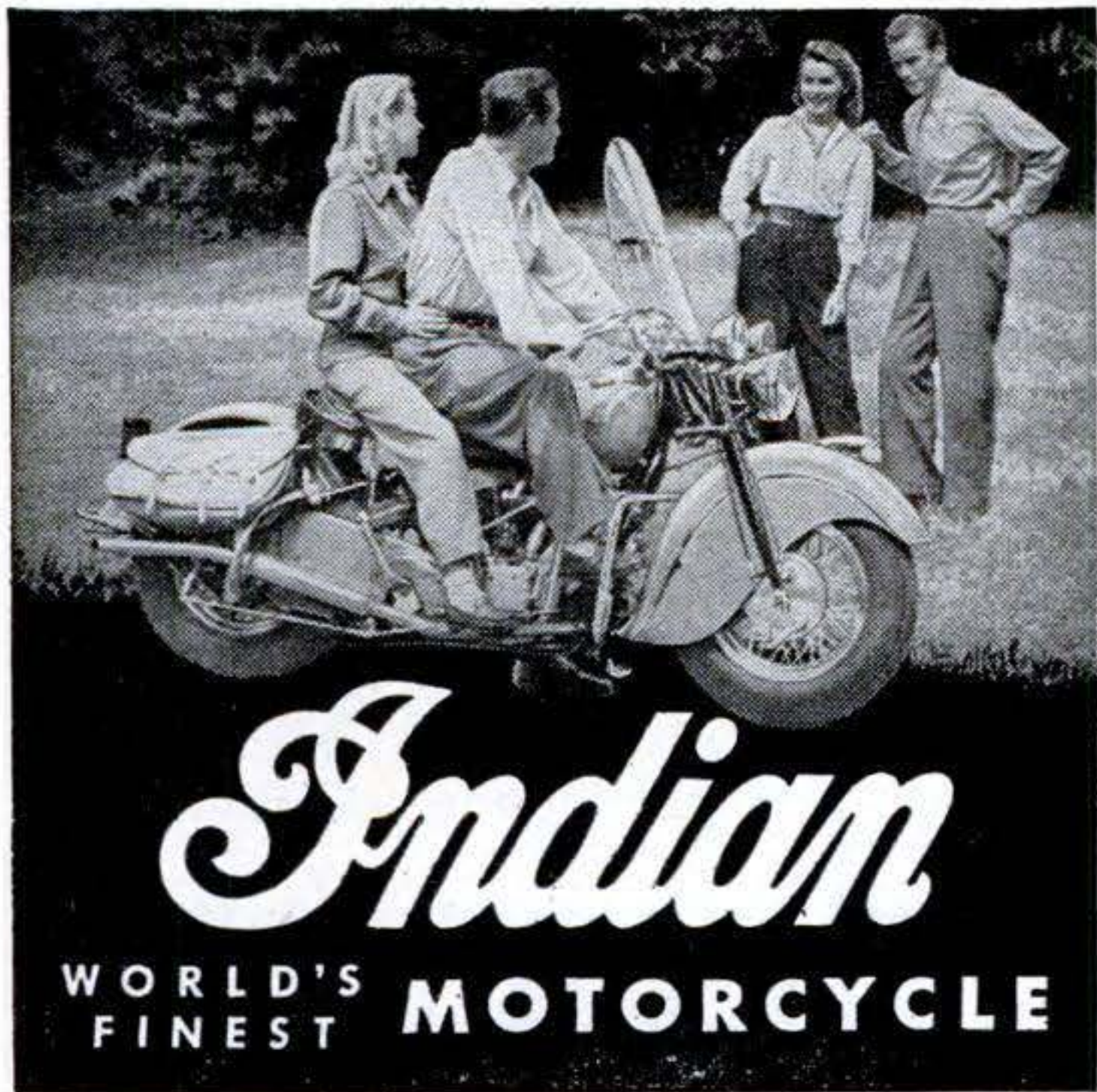

Send for FREE ILLUSTRATED MAGAZINE, "Indian News"
 • • • DEALER INQUIRIES INVITED • • •
 Dept. 9CS, Indian Motorcycle Co., Springfield 9, Mass.

VENETIAN BLIND
MACHINERY and EQUIPMENT
Write us for our Catalog
WRIGHT SALES CO., INC.
 9601 Carr Ave. • Cleveland 8, Ohio

FREE 8-PAGE FOLDER... Get this
"SOLDERING (easy as A-B-C)"

FOR EVERY HOBBYIST, CRAFTSMAN, AND HANDY MAN AROUND THE HOME. Simple step-by-step illustrations explain how to tin soldering irons, bind and solder wire splices, unite metals, etc. No obligation, just send us your name and address today. We'll mail your soldering folder without charge.

UNGAR Electric Tools, Inc.
 P. O. Box 2255-K Terminal Annex Los Angeles 54, Calif.

PEPSI-COLA ... Tops For Quality

NOW 93% MORE ENERGY, LONGER LIFE
Get the New "Eveready" Flashlight Batteries
 The term "Eveready" is a registered trade-mark of National Carbon Co., Inc.

BUILD YOUR OWN POWER LAWN MOWER

WHY BREAK YOUR BACK MOWING FIELD OR LAWN?

WRITE FOR FREE LITERATURE
 The Rite-Way Mower Attachment Ball Bearing

SAVE MONEY SAVE TIME
 Now anyone can save time and effort mowing field or lawn by building their own whirl type power mower. Build according to your own ideas and needs at small cost. Cut close to fences, walks, buildings, etc. Build in short time with parts and instructions we furnish. Save hours of time and back breaking labor. Write today for FREE information.

IT'S FUN TO BUILD

T & H MFG. CO., Dept. S-7
 811 E. 31, Kan. City 3, Mo.

Boy Chemist Wins \$100.00

You Can Do The Same

Meet Robert D. Whitaker, 14 year old Tampa, Florida boy, who won \$100 for research on catalysts. More boys have won fame and big awards with Gilbert Chemistry Labs than any other kind. Far more than "toy" sets. Range of chemicals and apparatus based on real laboratory technique. Write messages in invisible ink or fire ink. Make chemical weather flag. Do fingerprinting. Bleach flowers. Make paints, dyes. Hundreds of other spectacular experiments.

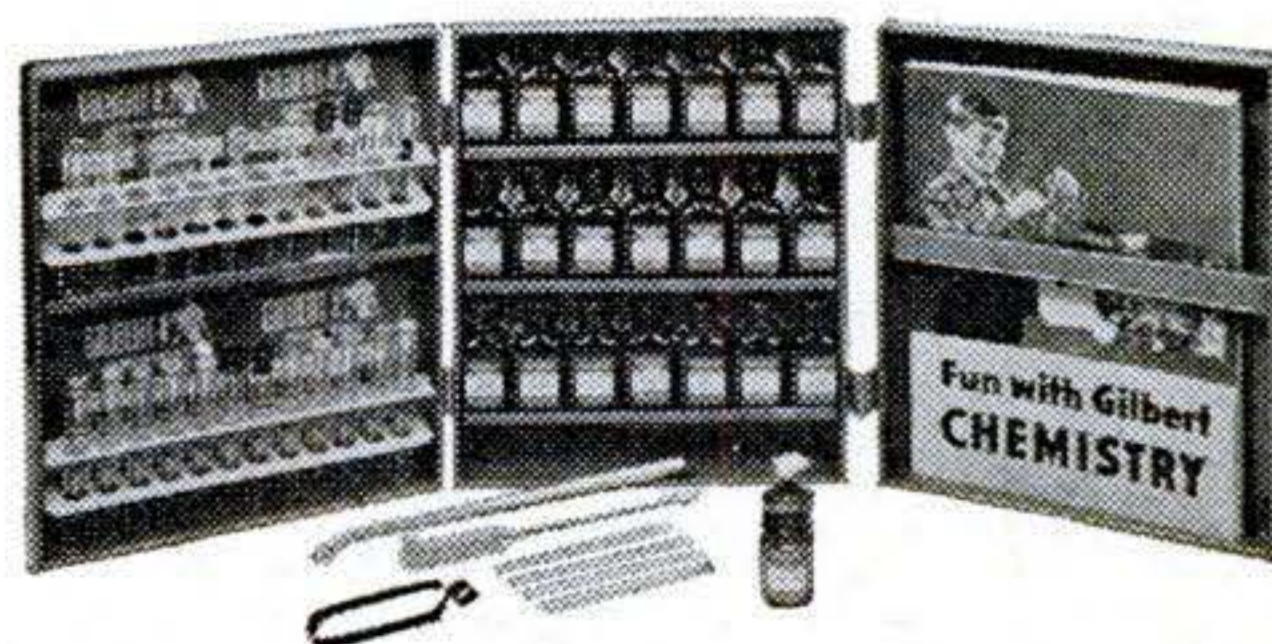

No. 6 Senior Laboratory. Big, three-compartment blue metal cabinet crammed with chemicals and apparatus. Puts 389 sensational experiments at your finger tips.

Developed at Gilbert Hall of Science

New GILBERT CHEMISTRY Labs

ALL THESE ADVANCED FEATURES

- NEW**—All metal cabinet—rugged, easy to carry.
- NEW**—Each section designed as complete laboratory with trays and racks.
- NEW**—Tip racks for test tubes, for easier handling.
- NEW**—Brown, light-proof bottles.
- NEW**—Rectangular shaped bottles and shelf spaces, holding bottles with label side out.
- NEW**—Postwar chemistry book. 144 big pages, illustrated, stay-open binding. Edited by Prof. Treat B. Johnson, famous Yale scientist.

\$200.00 IN CASH AWARDS To the boy doing what, in my opinion, is the most important research in Chemistry, Microscopy or Electricity in 1948, I will award \$100.00 in cash. To the ten boys doing the next most important research, I will award \$10.00 each. Applicants must not be over 17 years old and must send me a full description of their experiments by May 1, 1948.

A. C. GILBERT
Founder of the Gilbert Hall of Science

FREE—Illustrated catalog on new Chemistry Sets, Erector, other Gilbert scientific toys. Send name and address on post card. A. C. Gilbert Co., 212 Erector Square, New Haven, Conn. Offer good only in U. S. A.

If you make things or fix things, this unique tool will utterly astound you!

**It's a PLIER
It's a WRENCH
It's a CLAMP
It's a VISE
It's a . . .
WONDER!**

**SEYMOUR SMITH
Snap-Lock™
PLIER-WRENCH**

Serves as a plier — or the jaws can be locked, so hand pressure can be released and tool used as a vise. Swivel jaw holds objects of all shapes with terrific grip. Pressed steel body. Hardened (replaceable) jaws. *Guaranteed.* 10" size, \$2.25; 7", \$1.75. If not at your dealer's, order from us but give his name. Send for circular.

SEYMOUR SMITH & SON, INC.
900P Main Street — Oakville, Conn.

A Real Sensation!

Here's something needed in every shop

the New

**L-W Medium Duty 4-Jaw
Independent CHUCKS for
Small Lathes**

They will save you a lot of time and labor and permit much more accurate work.

PRICED WITHIN THE REACH OF ALL!

Semi-steel bodies. Face and outer edge surfaces ground. Steel jaws. Hardened and ground steps. Heat-treated steel screws. Complete with wrench.

Finished adapter back plates are suitable for some models of Atlas, Clausing, South Bend and Logan lathes.

ORDER TODAY or write for complete catalog

MFGRS. UNIVERSAL AND INDEPENDENT LATHE CHUCKS • MILLING MACHINE VISES • POWER HACK SAWS • DIVIDING HEADS • MAGNETIC CHUCKS • RECTIFIERS • DEMAGNETIZERS

L.W. CHUCK CO., 32 So. St. Clair St., Toledo 4, Ohio

6" HEAVY DUTY \$16.95

Semi-finished, ready to mount adapter back plate, 1½" — 8 thread \$3.00. Rough adapter back plate casting, \$1.25.

RUGGED 8" MEDIUM DUTY \$21.

Semi-finished, ready to mount adapter back plates, 1½" — 8 thread \$3.60. Rough adapter back plate casting, \$1.50.

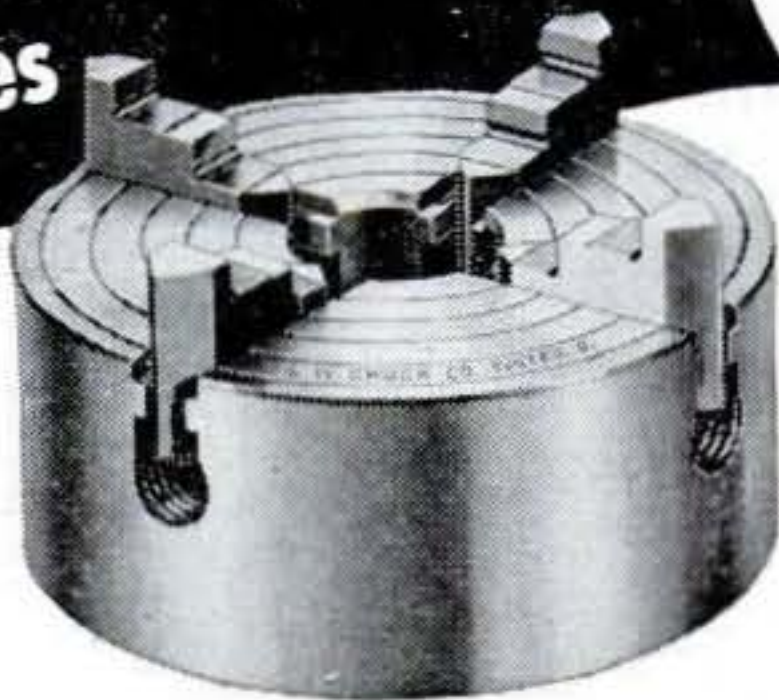

**FINE TOOLS
NEED
FINE OIL!**



• Lubricates



• Prevents Rust

• Cleans • Polishes

SOLD EVERYWHERE

3-IN-ONE Oil

TRAILER BUILDERS!

Insist on Safety-Engineered

- Bull Dog Hitches and Parking Jacks
- Torq-Less Axles

HAMMER BLOW TOOL COMPANY
D-18 Wausau, Wisconsin

Send for **FREE** Catalog

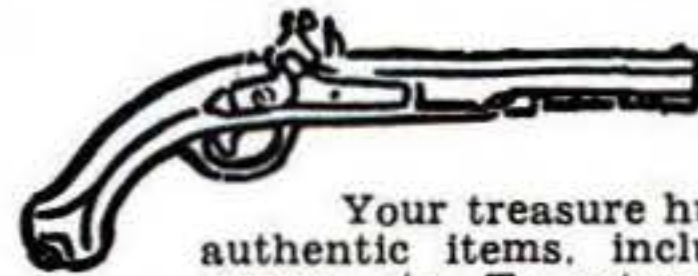

**GUNS-SWORDS
FIREARMS**

Your treasure hunt ends in our catalog listing 2400 authentic items, including old pistols, swords, knives, armor, etc. To get your illustrated catalog of over 172 pages, send 50c to cover postage and handling to **ROBERT ABELS, Box PS, 860 Lexington Avenue, New York 21, N. Y.**

500 TRICKS



MAGIC TRICKS

It's FUN to do MAGIC

Amaze — mystify — entertain. Be Popular. You, too, can enjoy this fascinating hobby which has swept America. Only 10c brings you our famous Catalog of 500 TRICKS, profusely illustrated, containing all the latest in easy-to-do magic for pocket, parlor, stage. Join in the fun! Send 10c today. **Douglas Magicland, Dept. P, Dallas 1, Texas**

**Fistula May Often
Result From Piles**

**FREE BOOK — Gives Facts On
Associated Ailments**

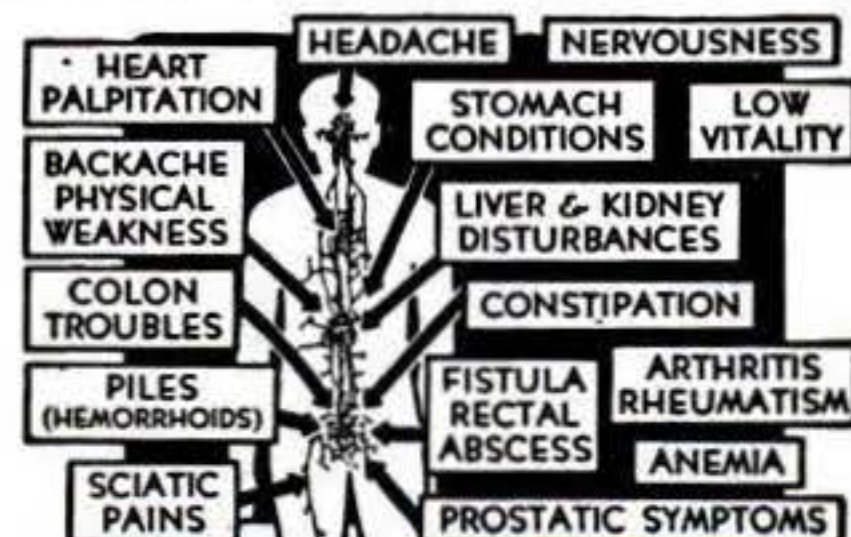

A new, illustrated 40-page book on Fistula, Rectal Abscess, Piles and other rectal and colon disorders is now **FREE** to all sufferers. Write today—a card will do. Thornton & Minor Clinic, Suite 1249, 926 McGee St., Kansas City, Mo.

Berkroy...

sheet metal equipment

Something New
in Metal Working
★

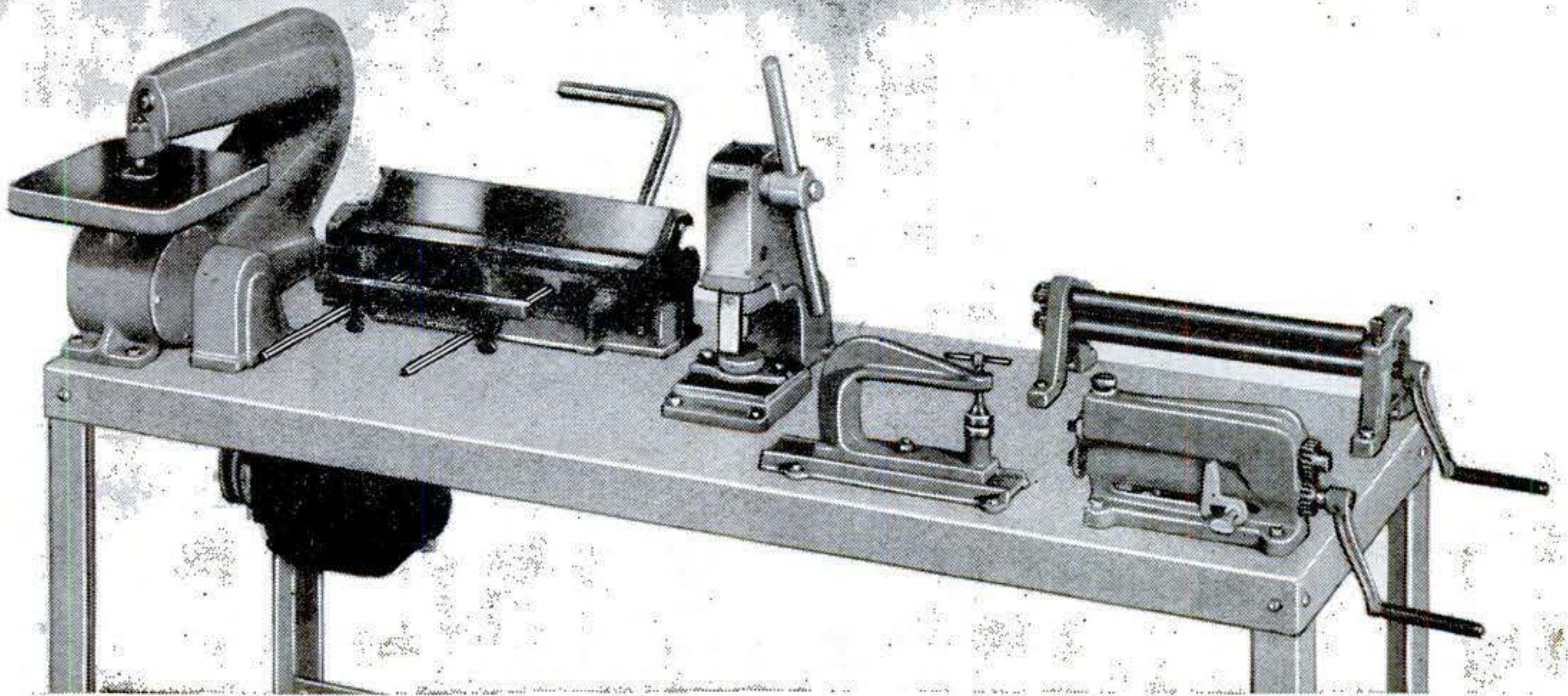

The compact Berkroy Unit completely equips your workshop for fascinating projects in sheet metal working. Mounted on the steel stand nearly 6 feet long, are five versatile metal working tools, that within their capacity, compare in performance to larger, far more expensive equipment. Each tool processes up to 20 gauge sheet steel. Heavier gauges of aluminum, zinc, pewter, copper,

plastics and other softer materials can be worked. The Berkroy Unit also has wide uses in industrial shops handling medium and small work at reduced costs and increased profits.

Complete set, stand and
five tools, less motor

No. 150 **\$217⁵⁰**
F. O. B. Factory

Send for free folder



BERKROY TOOLS SOLD IN SETS OR SINGLE UNITS



NIBBLER...
For cutting odd shapes, straight or scroll work. 8" square cast table, less motor. Scotch yoke driving mechanism in oil bath assures quiet operation.

No. 50 **\$49⁵⁰**

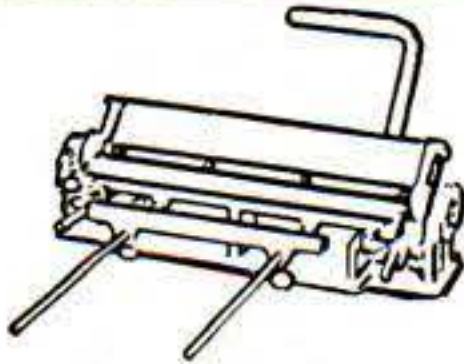

12" BRAKE...
For square or rectangular work and simple types of trim. Forms flanges, boxes, tabs, etc. Adjustable arm included for repeat work. Heavy cast iron frame.

No. 40 **\$43⁹⁵**



HAND PUNCH...
Used to punch sheet metal and to install pressed fits into small work. Cam actuated mechanism. With stripper plate. (Die sets and shear blades extra.)

No. 20 **\$27⁵⁰**

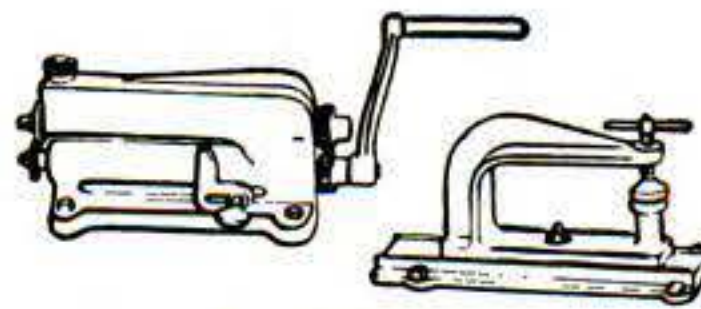

12" SHEAR...
Hardened and tempered cutters for straight line cutting, trimming, etc. No. 30 **\$19⁷⁵**

CLAMPING HEAD...
For cutting inside or outside circles. No. 3001 **\$7⁵⁰**

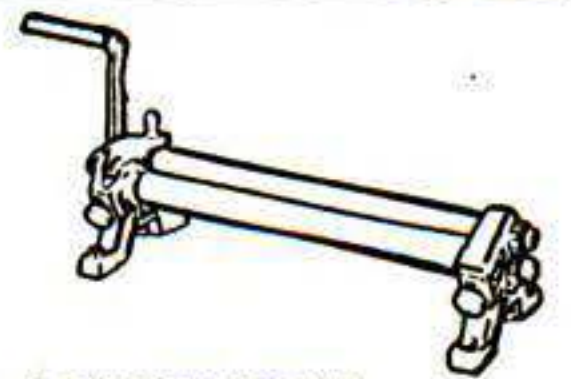

12" SLIP ROLL...
For forming cylinders, scrolls, reverse curves, etc. Simple, easy adjustment on rollers. Rigid cast iron frame, machine, cut gears ground steel rollers.

No. 10 **\$27⁵⁰**

BERKROY PRODUCTS, INC.

336 MAGNOLIA STREET
OAKLAND 7, CALIFORNIA

DISTRICT OFFICES:

WOOLWORTH BLDG.
NEW YORK 7, N. Y.
CORTLAND 7-8024

550 W. WASHINGTON BLVD.
CHICAGO 6, ILLINOIS
CENTRAL 1246

1672 MISSION STREET
SAN FRANCISCO, CALIF.
UNDERHILL 6682

700 COMMERCE STREET
DALLAS 2, TEXAS
CENTRAL 4075

Write Berkroy Office Nearest You

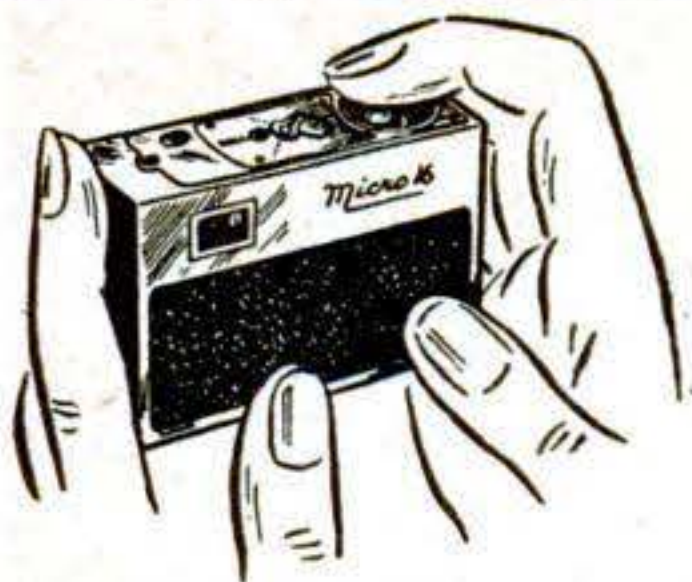

MICRO 16

The biggest little camera sensation in years! Compact, convenient! Smaller than a pack of cigarettes . . . weighs less than 9 ounces. You can carry it everywhere in pocket or purse. Precision built—all metal, easy to use—no focusing, easy to load—takes less than a minute. One dollar pays for film, developing and printing of twelve 2½ x 3¼ inch pictures. **COLOR FILM** . . . 10 frames for \$1.00 includes cost of film developing and return of positive transparency strip. **COLOR PRINTS** 40c each, 3 for \$1.00. Price of camera..... **\$29.50**

MAIL ORDERS FILLED

Liberal allowance on your used photographic equipment

Willoughbys

WORLD'S LARGEST CAMERA STORE
110 West 32nd Street, New York 1, N. Y.

U. S. NAVY 7x50

PRISM BINOCULARS

with Coated Optics

Used but in
EXCELLENT CONDITION

\$139.50

Tax
Included

Complete with leather
carrying case and sling

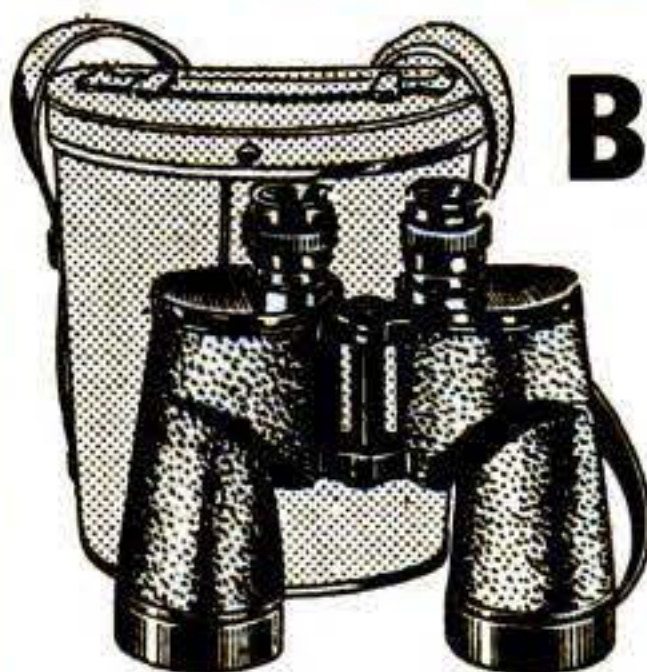

Engineers All Metal Army Type Hand-Sighting

LEVELS

\$2.00 PRECISION
QUALITY



Send \$1.25 for 3rd Edition of Gun Digest with our complete catalog of new and used guns, etc. Our separate catalog 25c.

PUBLIC SPORT SHOPS

13 S. 16th St., Phila. 2, Pa.

No COD's

ARMAND GRINDERS

The Ideal Gift for Men

Here is a sturdy 1/12 h.p. 110 volts, AC-50-60 Cycle grinder for Home Work Shops that will be a joy to any man, 8" high, 10" long, 6" wide, 2 grinding wheels, one fine one coarse.

Price \$23.85

At your dealer or write

CALIFORNIA DESIGN MFG. CO.
Dept. PSM12, P. O. Box 149, Burbank, Calif

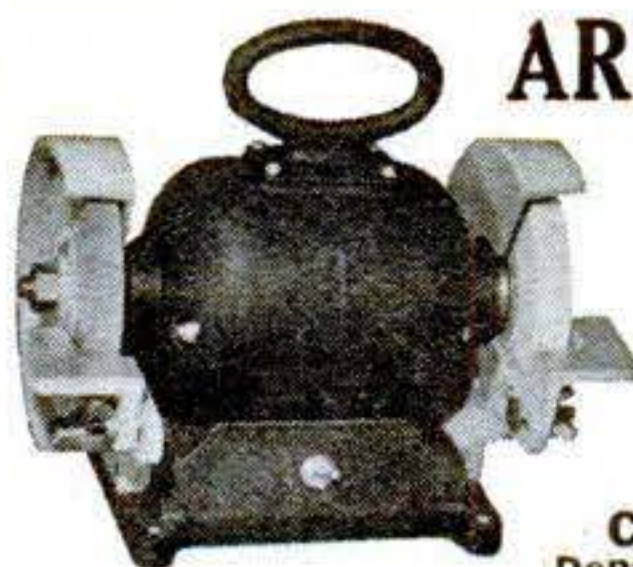

FOR HOME WORKSHOPS — FOR GARAGES

STEEL Tool and Spare Parts CABINETS...

GOVERNMENT SURPLUS!

BRAND NEW!

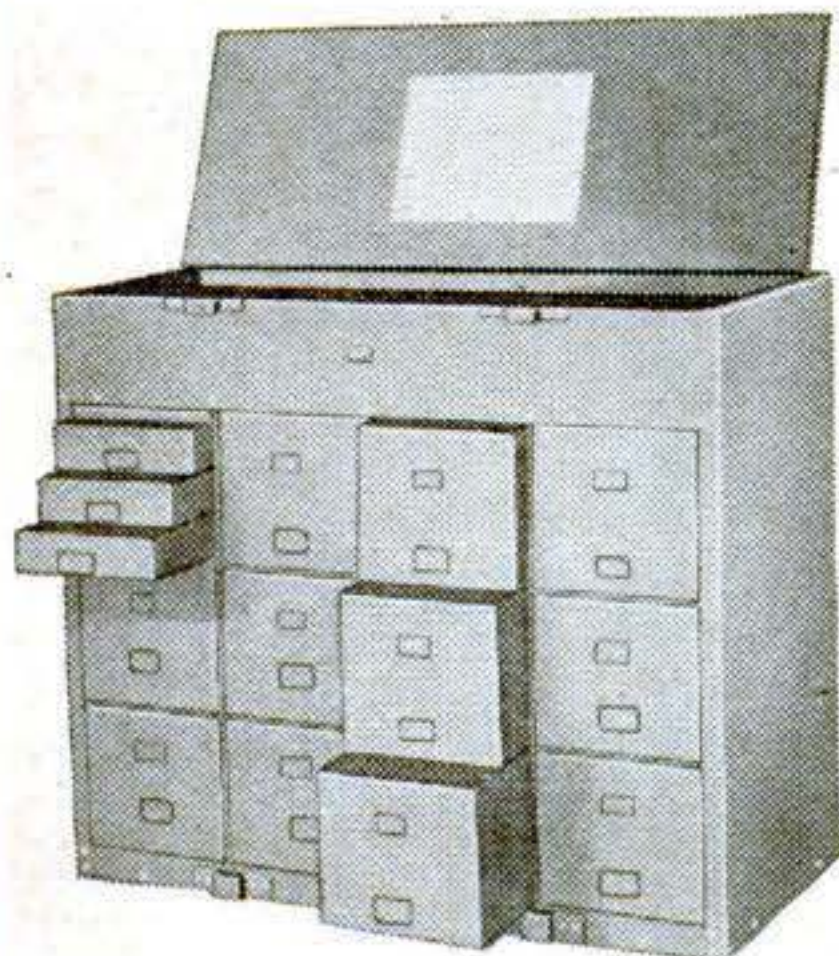

- All-Steel Construction.
- 4 ft. wide, 24" deep and 40" high.
- Entire cabinet secured with one lock.
- Drawers may be partitioned into 1" compartments.
- Masonite board riveted on top cover for use as a work bench.

Cash with Order or 1/3 down, Balance C.O.D. **Only \$55⁰⁰**

WEBER MACHINERY CO.

1801 E. 21st St.

Cleveland, O.

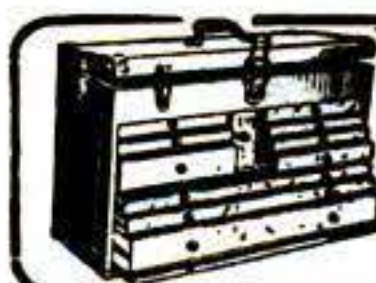

MACHINISTS—TOOLMAKERS

The sturdy structure and the finer finish of Gerstner tool chests, always please. Free catalog.

GERSTNER TOOL CHESTS

547 Columbia St.

Dayton 7, Ohio

\$13⁵⁰ Value for Only \$2.49

8000 ohm impedance Head Phones, produced to Air and Signal Corps specs. Extremely sensitive, lightweight (only 9 oz.). With 5½ ft. cord, plug, jack and ear cushions. Every One **BRAND NEW.**

No. 17A37, Special Per Pair..... **\$2.49**

Plus 25c each for Postage.



Burstein-Applebee Co. 1012 McGee, Kansas City 6, Mo.

New MILLING ATTACHMENT

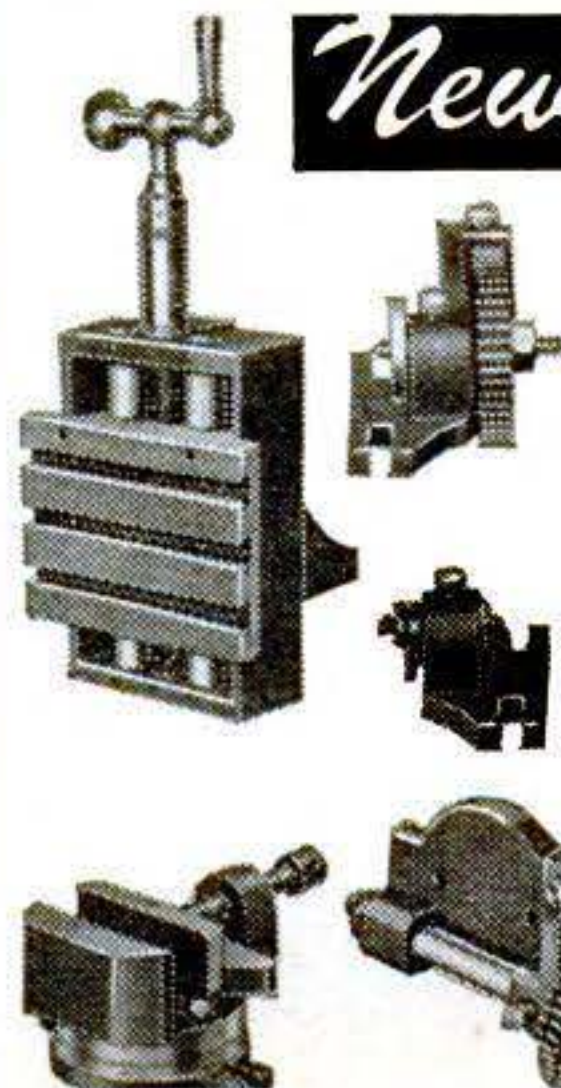

Sizes for 8" to 16" metal lathes
BUILD IT YOURSELF from our sets of semi-machined castings and save \$\$.

Can be finished on your lathe alone. Complete working drawings and step-by-step instructions furnished. Mill keyways, slots, splines, dove-tails, flutes in reamers, taps, hobs, and special cutters; produce spur, bevel, mitre and worm gears, ratchets and racks; mill flat surfaces, square shafts, mill hexes, spot face, drill spaced holes, bore, etc. on your lathe with this precision attachment. It has a T-slotted table, a vise which swivels for angular milling, a gear cutting fixture and dividing centers.

FREE! Illustrated folder and price list. Includes milling cutters, keyway cutters, drill rod, slitting saws and many hard to get shop items. Mention your lathe. Write today.

HURON MACHINERY AND TOOL CO.
YALE 2, MICHIGAN



MOTO-TOOL ★ The "Pocket-Size Machine Shop"



PRE-WAR PRICES STILL PREVAIL
 Moto-Tool Kit No. 2, lately would cost about \$30.00; you save \$6.50.)
 Moto-Tool No. 2 with 23 accessories (high speed steel cutters, grinding wheels, polishing accessories) and heavy-duty professional Model 2 Moto-Tool in natural-finish, hardwood case \$23.50.
 Moto-Tool Kit No. 1 with 34 accessories and Model 1 Moto-Tool in wood case \$17.50.
 Moto-Tool with one wheel point \$9.85.

Free Both Hands With Moto-Tool Attachments



Moto-Tool Stand (left) made of heavy cast iron, holds Moto-Tool at any position or angle \$4.50.

Moto-Tool Shaping Table \$2.50. (Shown with stand, right). Aids accuracy in routing, grinding.



DREMEL MFG. CO. DEPT. 127-M RACINE, WISCONSIN

A TOOL THAT PACKS EXTRA YEARS OF PLEASURE ... LOOK AT THE REST, THEN BUY THE BEST

Here's a tool to please a man's heart . . . one that holds promise of endless creative hours. Dremel Moto-Tool is a "war-veteran" . . . used by all branches of the Armed Forces in far-flung repair bases . . . helped to set production records at General Electric, Westinghouse, Remington Arms, Ford and others. Hobbyist or expert craftsman, first choice is Model 2 Moto-Tool Kit with its handsome felt-lined, highly finished wood case with rows of tools begging to be put to work. Write for FREE catalog of Moto-Tool attachments and accessories.

14 REASONS WHY MOTO-TOOL'S A BETTER BUY

- Housing has "pencil-type" finger grip
- Instant-action, wrenchless chuck
- Oil-less, (sealed) trouble-proof bearings
- Patented automatic chuck-lock pin
- Over-size armature shaft, hardened, ground and polished
- 110 volt, universal type (AC-DC) motor
- Easily replaced commutator brushes
- About 27,000 R.P.M. cuts cleaner . . . saves cutters
- Sliding snap-type switch
- Handy hanger hook; cord protector
- Sturdy, shockproof bakelite housing
- Dust-filtered, air-cooling system
- Weighs only 13 oz. . . . shaped to fit the hand
- Dynamically balanced for vibrationless operation.

MONEY BACK GUARANTEE

Buy Dremel Moto-Tool from your Dealer. If he cannot supply you, order direct from factory on 10 day trial. Shipped postpaid for payment in full (send check or money order); or send only \$2.00, we will ship C.O.D. You pay balance plus postage.



- Approx. 27,000 R.P.M.
- Do These Better—Faster**
- Polishing
 - Cleaning
 - Rasping
 - Brushing
 - Dressing
 - Burring
 - Grinding
 - Routing
 - Sanding
 - Drilling
 - Inlaying
 - Sawing
 - Scoring
 - Carving
 - Cutting
- Finishing
 - Sharpening
 - Burnishing
 - Engraving
 - Touching Up
 - Mortising



Authenticast Exclusive!

FAMED USS MISSOURI

Full-hull official scale model with replica of surrender plaque



Kit plaque is size of a quarter ready for mounting.

A DREAM OF A MODEL . . . you'll have hours of fun building it! And you'll enjoy owning this fine model for years to come.

Authenticast assembly kit includes easy directions, diagram, tools, over 100 cast-metal precision-perfect parts. Scale: 1 inch to 500 inches, finished model is 21 inches long. Priced \$12.95 complete at hobby shops.



Send 35c in coin for colorful 32-page Authenticast catalog.



132-01 91st Avenue, Richmond Hill 18, L. I., N. Y.

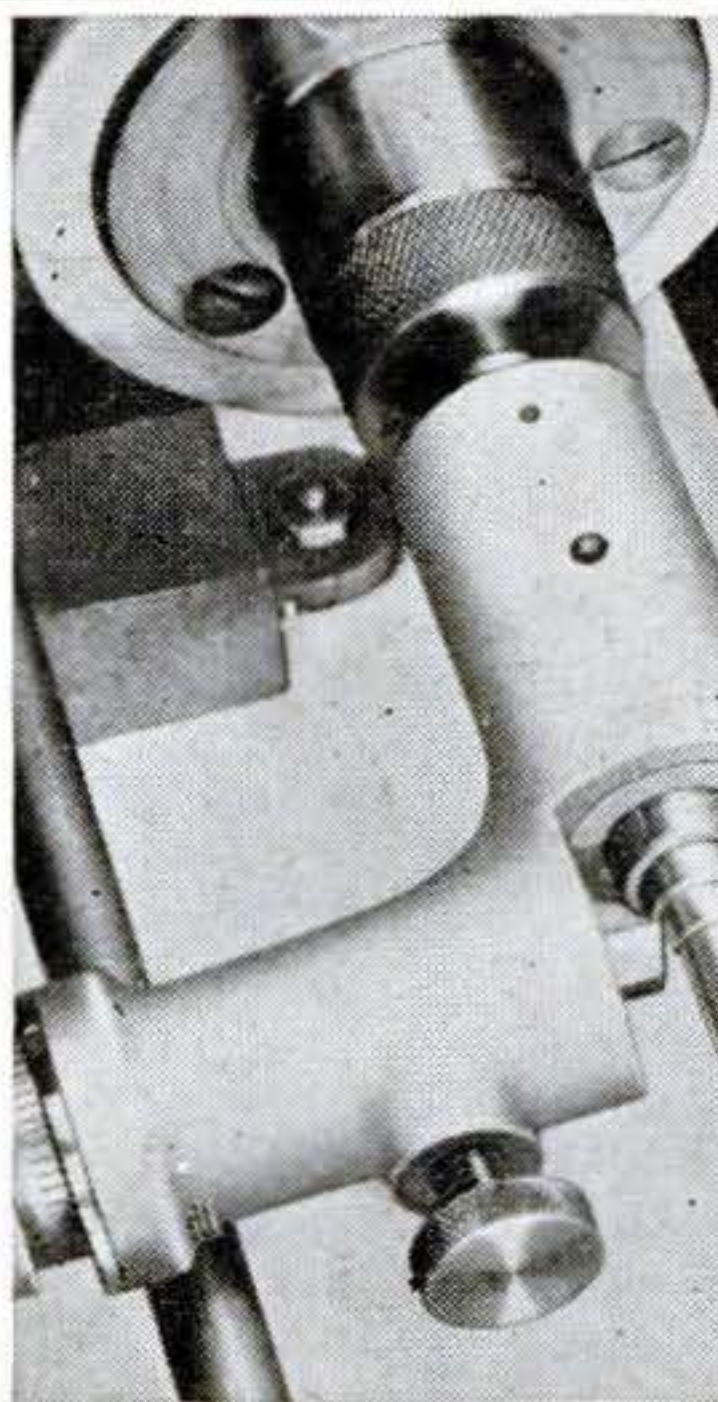

NEW!

TRU-TURN

IDEAL CHRISTMAS GIFT

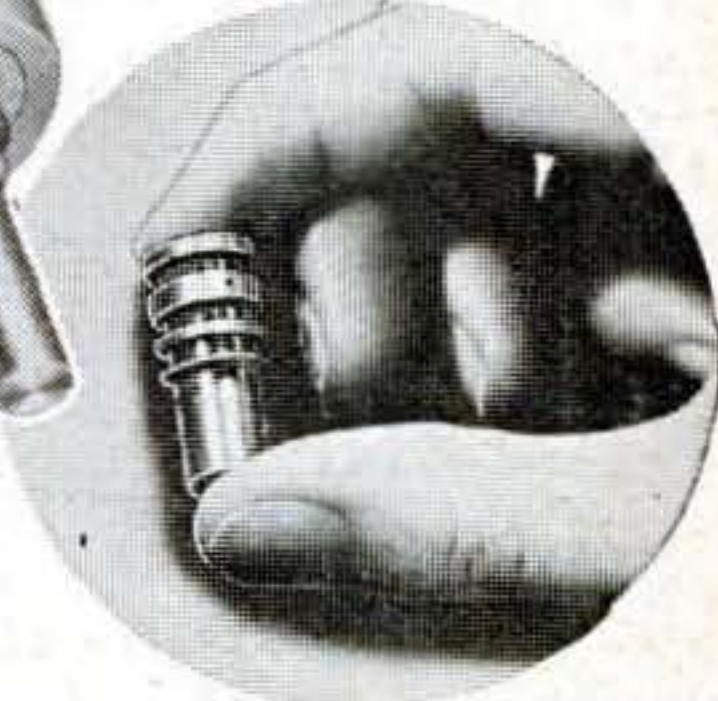

It is now possible for home craftsmen . . . and garagemen, gunsmiths, and repairmen . . . to turn and cutoff metal without buying an expensive lathe. This new tool converts woodturning lathes, drill presses and grinder stands into precision metal lathes. TRU-TURN has a built-in micrometer . . . turns and cuts-off steel, brass, aluminum.

TRU-TURN TOOL — Two guide bushings; and bits for steel, brass and aluminum . . . only \$11.75

FACE-PLATE WORK-DRIVING CHUCK—For converting woodturning lathe. Chuck plus three adapter bushings . . . only \$4.50

Add 25c to each item for C.O.D. orders. Send money order or checks for prepaid shipment within U.S.A. Illustrated folder free.

MILLHOLLAND SCREW PRODUCTS CORPORATION
 132 West 13th Street, Indianapolis 2, Indiana

BOICE-CRANE POWER TOOLS

for shop men and
homecraftsmen.



BAND SAWS



JIG SAWS



DRILL PRESSES

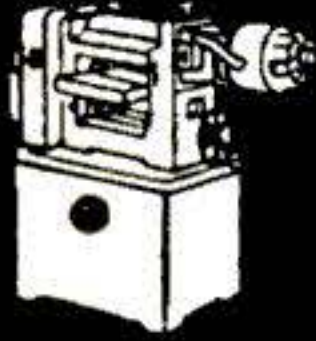

THICKNESS PLANERS

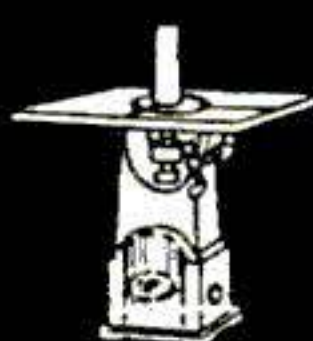

SPINDLE SANDERS

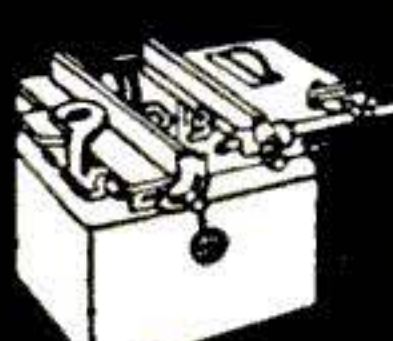

SAW-JOINTERS

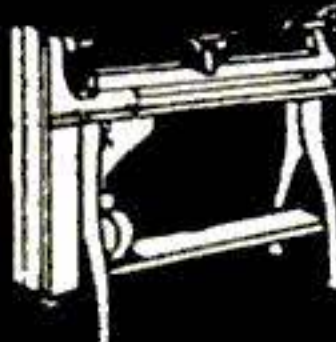

LATHES



SPINDLE SHAPERS

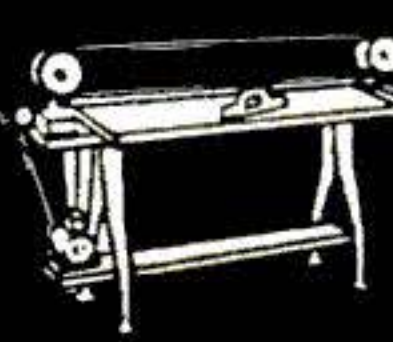

BELT SANDERS

Write for literature on this
versatile, low-cost,
sturdy line.

BOICE-CRANE COMPANY
944 Central Ave., Toledo 6, Ohio

THE MACHINE THAT AMAZED THE EXPERTS!

BANDSANDER IS BACK AGAIN!

The remarkable, economical home-shop Bandsander is again available for immediate shipment! Quickly shapes, sands, carves and polishes wood, metal, plastics! Works equally well on inside cut-out opening or irregular outside edges, on intricate scrolls, curves. Gets at places no other can! Patented. Tilting table for bevelling, chamfering. Rust-and-sweat proof top. Self-oiling sleeve bearings. Saves time, labor, money. Invaluable to homecraftsmen, hobbyists, model-makers, etc. Normal band speed 1600 ft. per min. gives fast, smooth, clean cuts. 1/4 hp 1725 rpm motor recommended. Rush only \$14.95 with order—or \$5. balance COD. 5 Days Trial, Money Back Guarantee. Prompt shipment. Limited supply—so hurry! Dealers write! (Or send postcard for Free details.)

MEAD SPECIALTIES CO.,
4114 N. Knox Ave.,
Dept. 2127, Chicago 41,
Illinois.

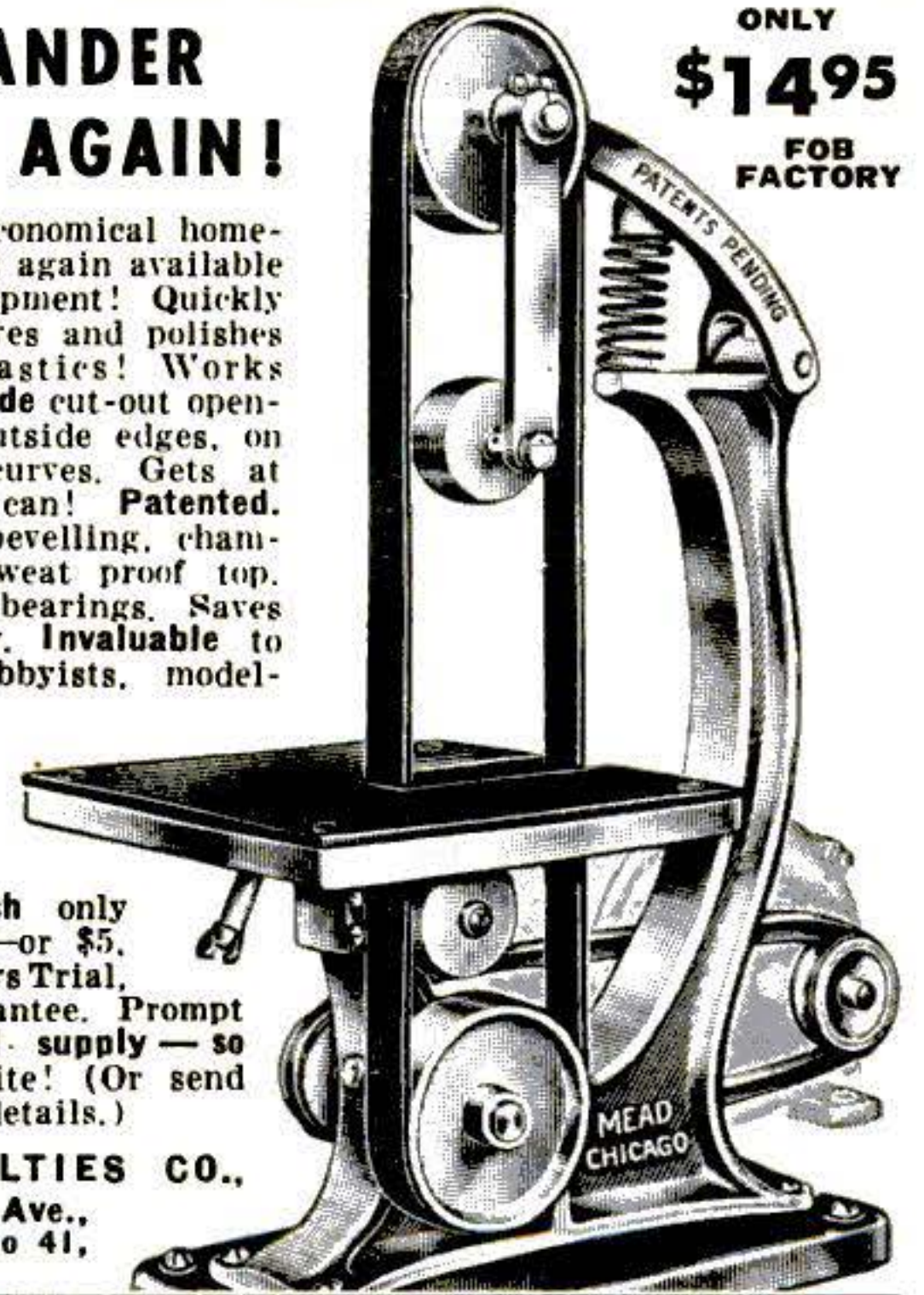

ONLY
\$14.95
FOB
FACTORY

Do your own professional

FELT FLOCK FINISHING

with complete spray outfit

Now you can apply a professional, colorful, felt flock finish on hobby crafts, novelties, art objects, lamps, furniture, toys, etc. Velvety, durable, easy-to-apply finish. Available in 10 brilliant colors. Complete outfit (as pictured) includes undercoat, brown and ivory flock, solvent, brush, patented spray gun and instructions. Complete price \$9.25 post paid. Write for FREE circular and color sample card



BEROTT-ROSS • Dept. 12-B411 No. Foothill Road, Beverly Hills, Calif.

BUILD YOUR OWN FAST FREEZER

PLANS
\$1

It's easy to build this household appliance with LeJay Plans. Made from new or used parts. Save up to 75%. No expert knowledge needed. Plans show 5 sizes and are easy to follow. All details clearly explained. Enjoy making one of these freezers. Mail \$1 for set of plans and catalog. **LEJAY MFG. CO.,** 423 LeJay Bldg., Minneapolis 8, Minnesota



5 sizes
8 to 40 cu.ft.

Ottawa Self-Propelled Buzz Master

CLEAR LAND FAST! Powerful 7-HP motor with friction clutch for safe operation. Cuts down timber, brush and hedge; turn blade vertically and saw logs to length. Also furnished with post hole diggers. Has clutch pulley for belt work.

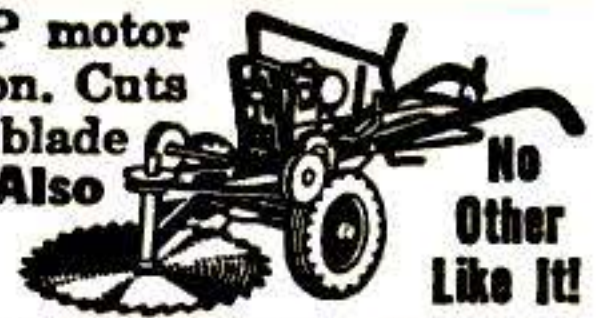

OTTAWA MFG. CO., 1-701 Brush Ave., Ottawa, Kansas

Now a DYNAMIC Industrial Transformer Type Super Charged WELDER

FOR AUTO, HOME APPLIANCE AND FARM REPAIRS

DESIGNED TO DO HIGH GRADE WELDING *inexpensively*—Maintenance Men, Farmers, Mechanics, Machine Shops, Foundries, Auto, General Repair and Job Welding Shops, all using the DYNAMIC find it so indispensable and useful that they can't afford to be without it. **EASY-TO-OPERATE.** If inexperienced you can easily learn to do a variety of high grade welding jobs by following the practical, *simplified Welding and Operating instructions furnished.* Once you see the DYNAMIC in operation you won't want to be without it. Its simplicity will amaze you. In a year the DYNAMIC only costs you about 7c a day. Comes complete ready to operate with helmet, rods, cable, holder, operating and welding instructions, etc.

**AN IDEAL AND PRACTICAL GIFT FOR ANY MAN
SAVES YOU VALUABLE TIME AND MONEY**

This portable, industrial transformer type *Dynamic Welder* easily carried right to the job can be operated from any convenient properly wired 110 Volt 60 Cycle Line. **WORKS on IRON, STEEL, BRASS, BRONZE and Other Metals.** Has 8 metallic and carbon arc heat stages. Does work you would think only possible with a larger more expensive machine... Can also be supplied for 220 VOLT 60 CYCLE operation and other voltages and cycles at slight additional cost.

DYNAMIC WELDER CO., 13 East 23rd Street, ST, CHICAGO 16, ILL.

FOR ONLY

\$2850
COMPLETE

**DO YOUR OWN
WELDING**

Just a few repair jobs will pay for this machine. A practical and profitable machine tool for any workshop. Make money doing repair work for others.

Write for Particulars
Get Details on our
10 day Trial Offer
Member Chicago
Association of
Commerce.



New!
MANI-DAPTOR

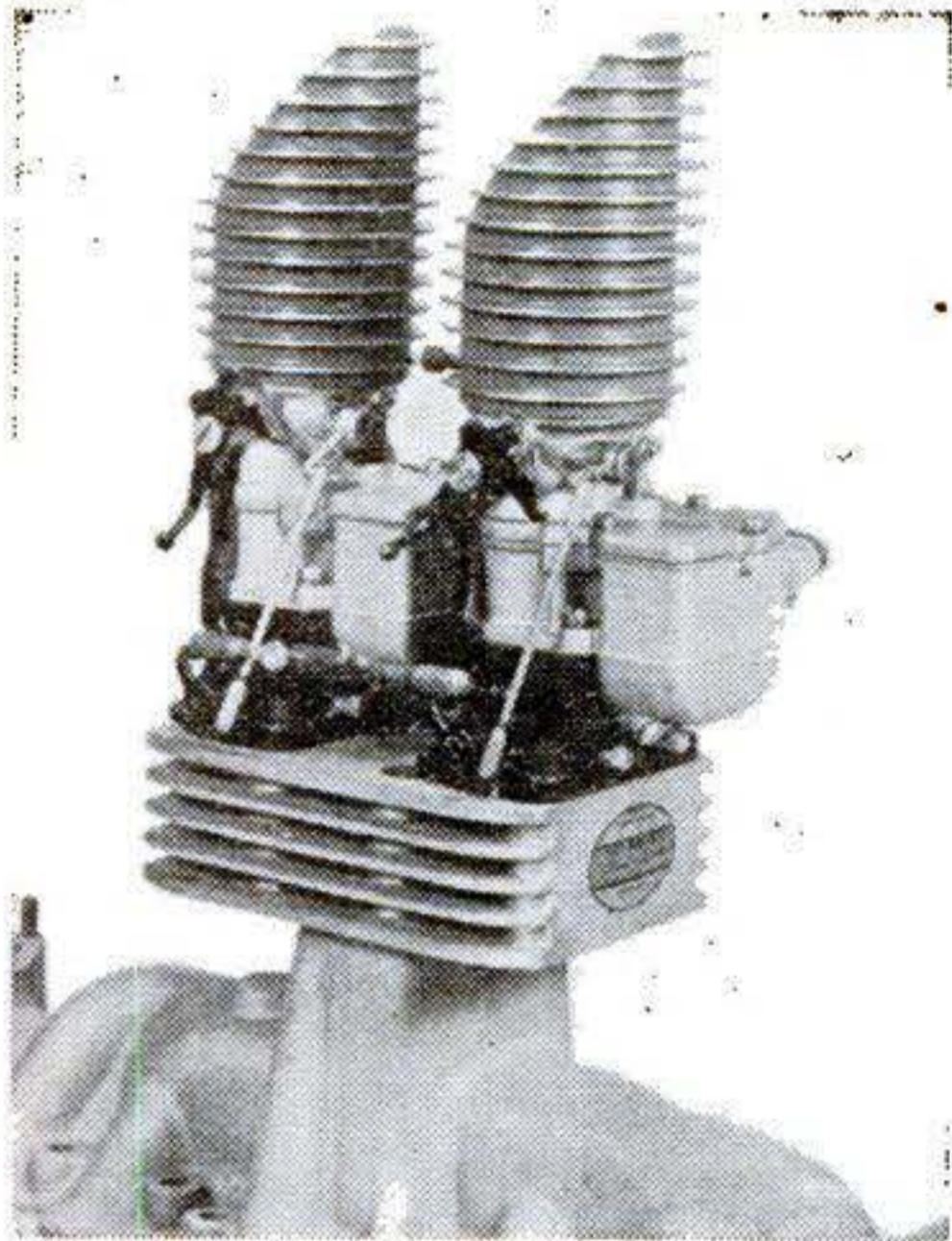

Mani-Daptors for immediate installation complete with fittings and simple, easy to follow directions are available NOW! at an amazingly low price.

Ford V-8's
Hudsons
Buicks
Lincoln
Zephyrs

\$26.50

Postpaid

All others \$32.00

TWIN CARBURETION UNIT

AVAILABLE FOR INSTALLATION ON ANY CAR
• INCREASES POWER • SAVES GAS • INCREASES SPEED

The Mani-Daptor steps up your motor's efficiency by approximately 20%. It puts to work horse-power which has been lying idle. Firing order is at no time affected by fade-outs and yet you save on gas!

GASOLINE SAVED One truck user reports a regular 23 gallon gasoline-consumption-run was reduced to 17½ gallons—time for the run was reduced 2½ hours as high gear driving became possible throughout the trip. The average car mileage increases 5 miles per gallon with Mani-Daptor installation.

POWER & SPEED INCREASED A 1933 Ford V-8 (stock) was clocked at a top speed of 72 mph. With a Mani-Daptor it was clocked at 96 mph. Power and pick-up is noticeably increased on every car.

Dealer or Distributor
information upon request.

ORDER NOW

LES BACKUS
10617 Prairie Avenue
Inglewood, California

Orchard 7-8545

Please rush a Mani-Daptor unit for a.....
Total Cost \$.....check enc.....make.....model.....cylinders.....money order.....COD.....
Name.....
Address.....
City.....Zone.....State.....

REAL GAS ENGINE \$6.95

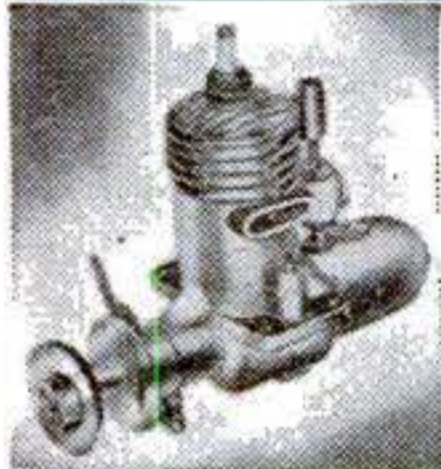

The new THOR "B"—Sensational miniature gasoline engine that really works. Super-power performance. Smooth, velvety power that roars into action with a "twist of the wrist." Over 25,000 already sold. 1/6 H.P. Complete with coil and condenser. Ready to run, only \$9.95. In KIT form, fully machined, 5 minutes to assemble, \$6.95, without coil and condenser. Powers all models. Fully illustrated instructions. Send \$1.00—shipped collect same day C.O.D. FREE. Send for 24-page Illustrated Hobby Catalog.

AMERICA'S HOBBY CENTER
Dept. S-127, 156 W. 22nd St., N. Y. 11

SMALL EFFICIENT SPEED REDUCER

Just the thing for the Home Work Shop, Hobby Shop, Bench Work, Animated Displays, Light Production work. Used daily in thousands of homes and shops. Sturdy, compact, (see dimensions). Case of aluminum. Gears, SAE 65 (British) Gear Bronze. Worm of case hardened steel. Timken Bearings throughout. Torque capacity 100 inch pounds Available in 4 different assemblies (shown below) and in these standard ratios:

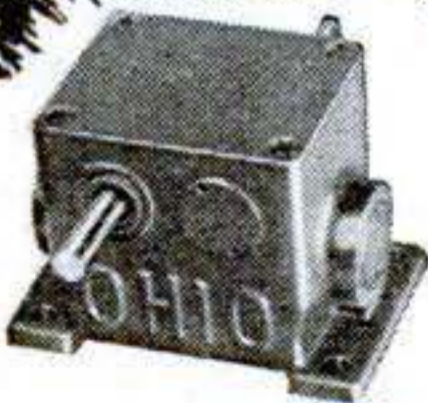

\$18.56
NET — POSTPAID

4-1	25-1	64-1	200-1
8-1	30-1	75-1	200-1
10-1	40-1	80-1	400-1
16-1	50-1	100-1	600-1
20-1	60-1	150-1	800-1

When ordering be sure to specify assembly and ratio required. Shipping weight in carton, 8 lbs. Full money back guarantee. Prompt deliveries.

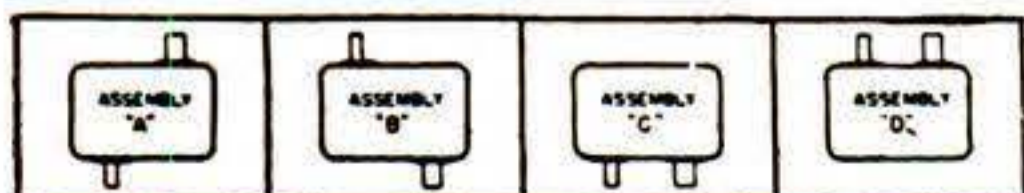

THE OHIO GEAR Co.
1432 EAST 179th ST. • CLEVELAND 10, OHIO

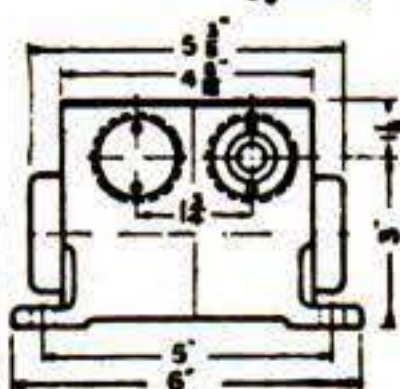
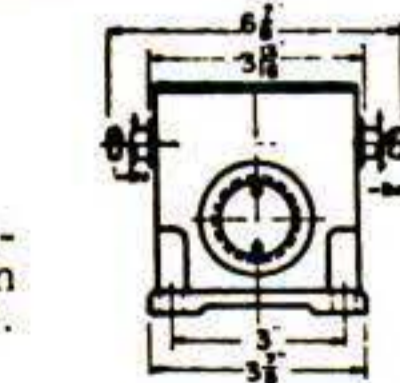

Say You Saw
It In Popular Science

ARC WELDER

BUILD YOUR OWN!

For light or heavy work. No rewinding necessary. 16 Heats. Use old auto generator coils. Complete plans and catalog. 35c. LEJAY MFG. CO., 3323 LeJay Bldg., Minneapolis 8, Minn.

CAST ALUMINUM DOUBLE EXHAUST BLOWERS \$15.85

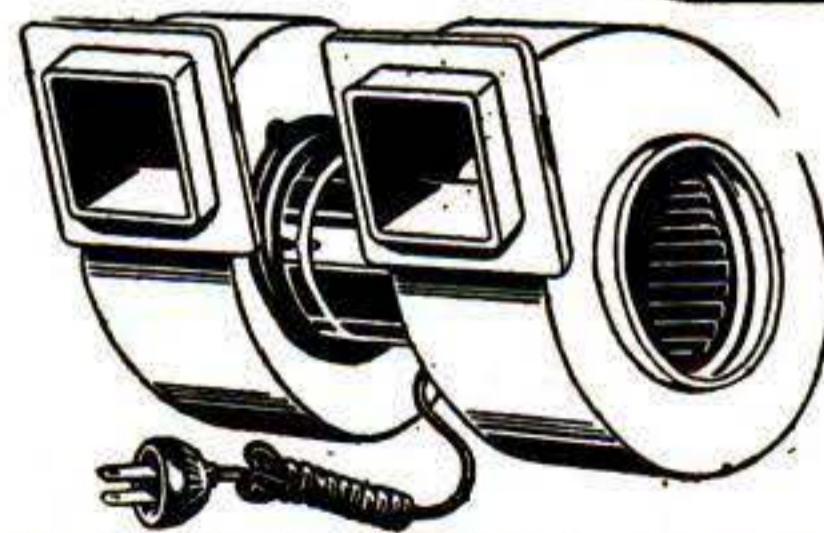

For COAL FURNACE BLOWERS (Save 31% on Coal Bill)—AIR CONDITIONERS — HUMIDIFIERS — DARKROOM DRIERS — LABORATORIES — WORKSHOPS — HOSPITALS — LAUNDRIES — OFFICES — PRINTERS.

Double intake and exhaust from 2 balanced sirocco type wheels. Will easily solve your forced draft and fresh air problems. Blower designed especially for quick and simple installation. Anyone can do it with ordinary household tools. Blower housing is heavy cast aluminum to last indefinitely. Cont. duty motor is extraordinarily quiet. 110 V., A.C., 50-60 cycles. Cord attached, ready to plug in.

WE GUARANTEE SATISFACTION! NOW! ONLY \$10.00

While they last! Our famous single exhaust blowers DELIVER 100 CU. FT. AIR PER MINUTE. Ready to install yourself with any household tools. It's built for that! 110 V., 50-60 cycles. Cont. duty motor. Send check, money order. No C.O.D.'s. West of Mississippi add \$1.00 for mailing, handling. IMMEDIATE DELIVERY. Service men and dealers: Inquire about quantity discounts.

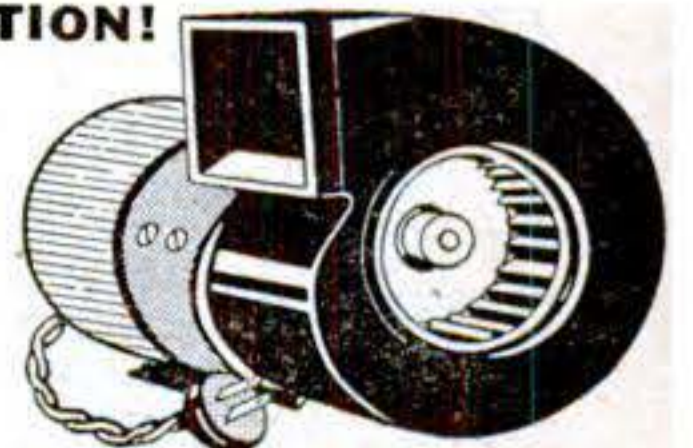

UNIVERSAL YONKERS CORP. (Dept. M12) 137 Alexander St., Yonkers 2, N. Y.

This Christmas
give the gift of a "Lifetime"

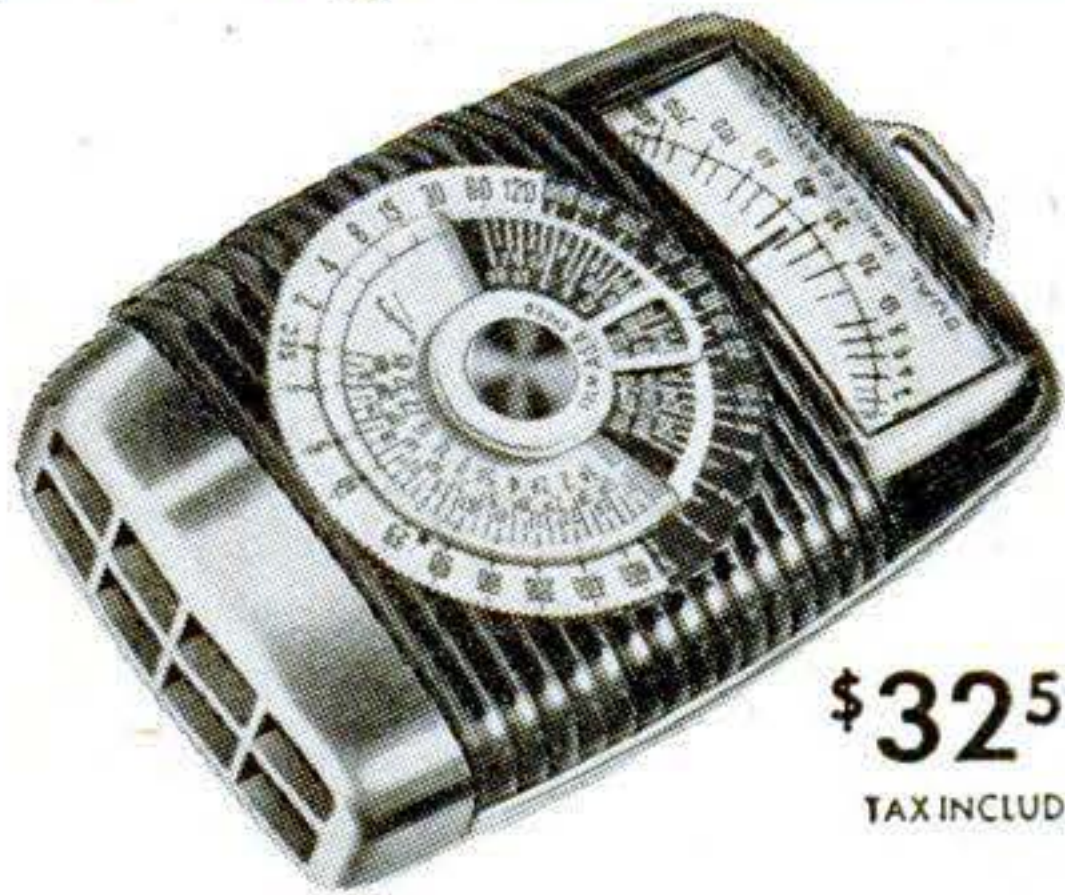

\$32.50
TAX INCLUDED

DeJUR *Lifetime*

dual purpose exposure meter The only meter that gives accurate incident and reflected light readings . . . automatically. *Guaranteed for a lifetime of accurate service*

DeJUR-AMSCO CORPORATION

45-01 Northern Blvd., Long Island City 1, N. Y.
West Coast: 426 W. 11th St., Los Angeles, Cal.

HERE'S VALUE!
Precision-Built
TOMLEE SANDER

Weight
21 pounds



AVAILABLE
NOW!

PRICE
\$17.50
F. O. B.
Minneapolis

FEATURES

- ★ Solid Cast Iron Construction
- ★ Chrysler Oilite Bearings
- ★ Three-Point Mounting
- ★ Belt Trackage Adjustment
- ★ Table Tilts 90° for Vertical Sanding
- ★ Belt Tension Adjustment
- ★ Work Support Adjustable to 60°
- ★ Uses Standard Abrasive Belt

Available at Hardware Stores

TOMLEE TOOLS
THE BIG VALUE LINE

Tomlee Tool & Eng. Co., 740 No. Washington Ave., Minneapolis 1, Minn.

Stucco Spraying
• Today's Outstanding Business Opportunity



Beauty and protection are sprayed on old and new buildings . . . exterior and interior surfaces . . . by COLORCRETE. It's a plastic, water-resistant material, spread evenly over surfaces and forced into cracks by air pressure. Fuses to masonry with enduring tenacity. Many textures. Range of 30 smart colors. Fully proven by 20 years of actual use under all conditions.



BIG EARNINGS FOR COLORCRETORS

Colorcrete ties in with today's huge building program. Renews old buildings. Makes new construction more attractive and enduring. Large waiting market, because building owners get long lasting beauty and protective values at low price. Yet your selling price can be several times your basic cost. Machine is easy to operate. Moderate investment. Write or wire for complete information.

COLORCRETE INDUSTRIES, INC.
572 Ottawa Avenue Holland, Michigan

COLORCRETE

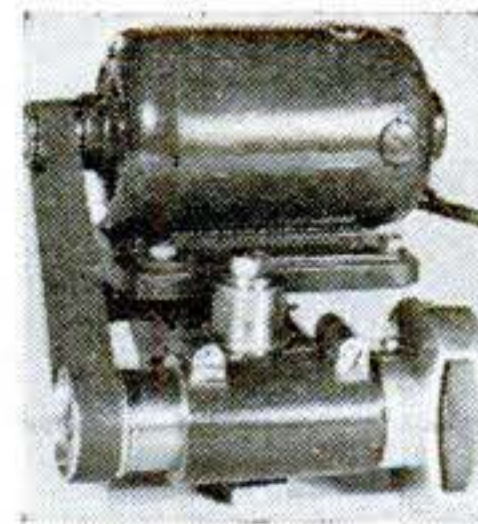

BUILD YOUR OWN

Tool-post Grinder

FROM OUR

PRINTS, CASTINGS & PARTS

PRINTS AND CASTINGS - ONLY \$12.00

Send for Free Illustrated Circular

WORKSHOP TOOLS, Box 518, Merrick, N. Y.

★★★ **MACHINERY** ★★★

LATHE—DRILL PRESS—SAW—Now Ready—Others On the Way—All Metal—All Machining Completed—Assemble Yourself and Save—Folder 947M on Above 10c. Refunded on First Order. Catalog 1046 on Tools—Aluminum—Plastics—Supplies—Equipment, etc. 15c.
Metiplas Supply Co., 1420 So. 16th Ave., Maywood, Ill.

ONE-MAN SAWMILL LESS THAN
Easy To Turn Trees Into Money **\$200.00**

Makes Lumber ties, shingles, crates, lath, studding, siding.



BELSAW MODELS

in 10 to 24 foot sawing lengths. MECHANICAL FEED, accurate set works and positive dogs. Use tractor or old auto engine for low cost power. Thousands used for commercial sawing. Pays for itself quickly. Send post card today for FREE booklet, "How To Make Lumber" and Catalog of Woodworking Equipment.

BELSAW MACHINERY COMPANY
2846F Field Bldg., 315 Westport Rd., Kansas City 2, Mo.



The **HOME CHEMIST**

A new book which shows how to set up and operate an inexpensive home laboratory with odds and ends of material available in every home. Many thrilling, practical, useful experiments and tests, entertaining, instructive, valuable, pointing the way to research and new discoveries. Many diagrams and illustrations. Full cloth bound \$1.49.

POPULAR SCIENCE MONTHLY, Dept. 127
353 Fourth Ave. New York, N. Y.



The best *Christmas Present* I ever got

GIVE AN EMRICK—ASK FOR AN EMRICK

HERE'S WHY: **5** MOST USED
POWER TOOLS IN 1 RUGGED
UNIT FOR ONLY \$34.95

ONLY
\$34⁹⁵

Power tool fun and profit are built into the Emrick Universal Woodworker. Versatile. Rugged. Compact. Big capacity. Heavy—shipping weight 65 pounds. Drill press pulls 1/2" drill in steel. Saw uses 6" to 8" blade. Arbor also takes all standard accessory wheels such as wire brush and cloth buffer. Lathe turns pieces 30" long by 10" dia. Disc sander 8" dia. 5" grinder. Heavy replaceable bronze bearings at all wear points. Only \$34.95 because sold direct from factory to you. **MONEY BACK GUARANTEE.** Order early for prompt shipment.

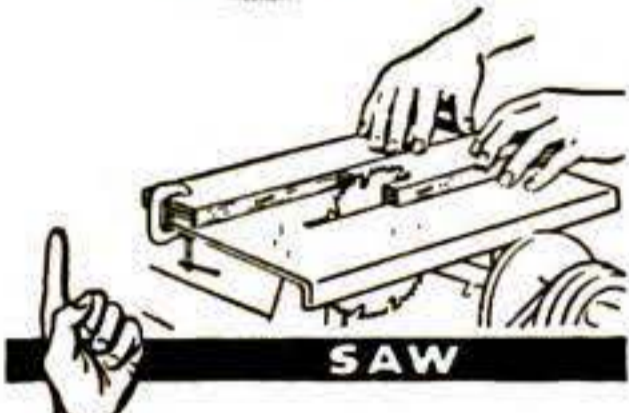
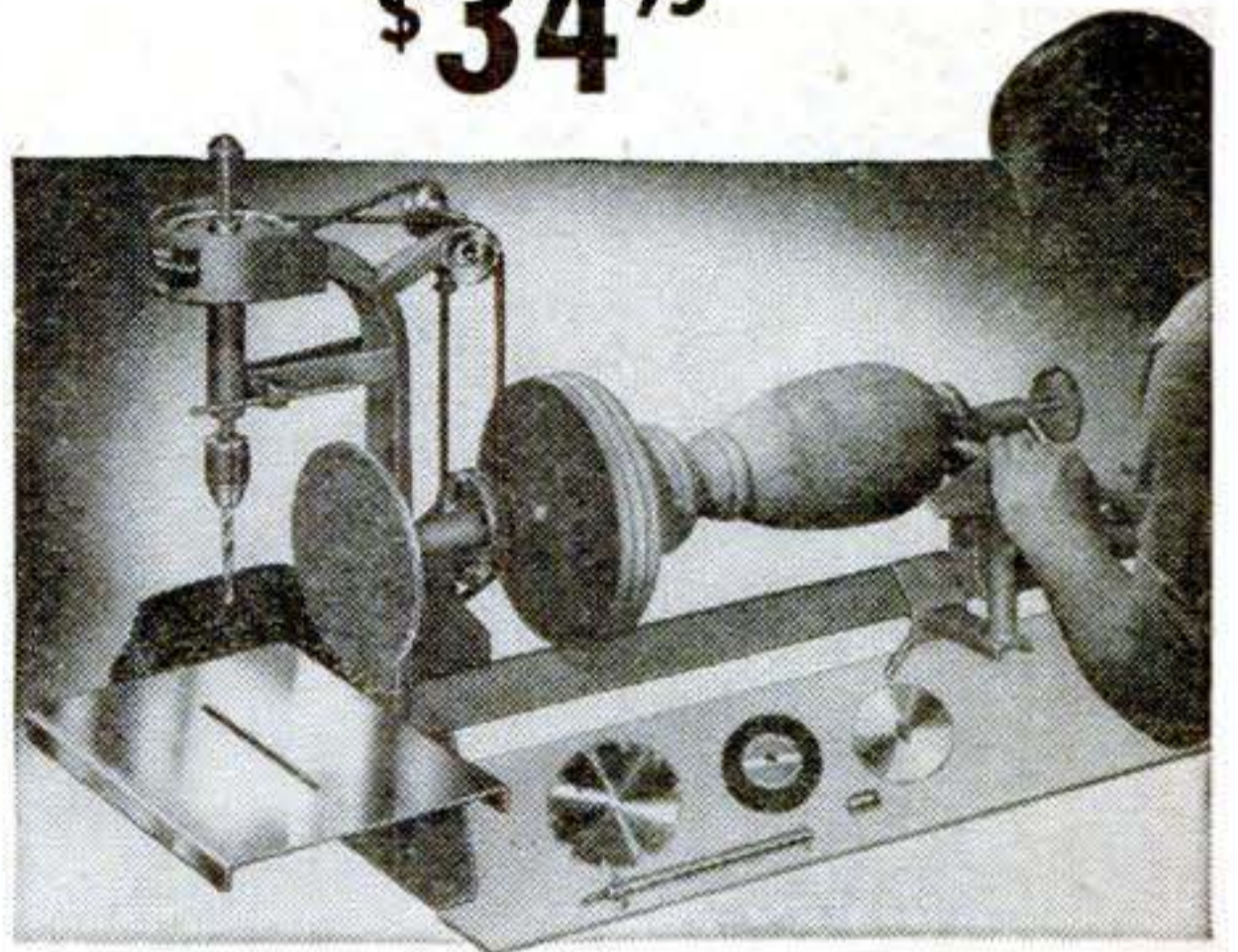

SAW



LATHE

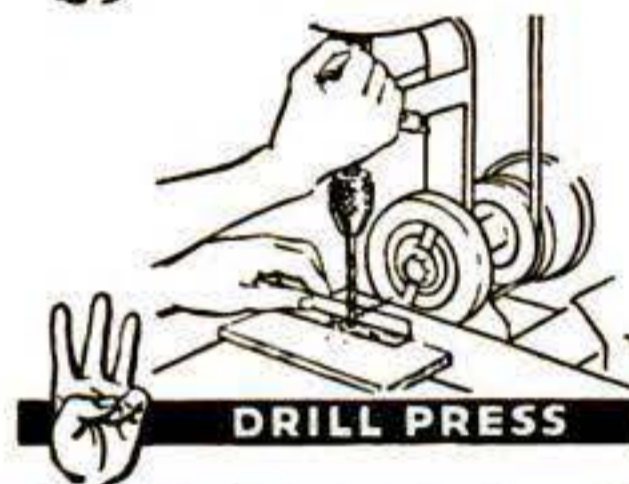

DRILL PRESS

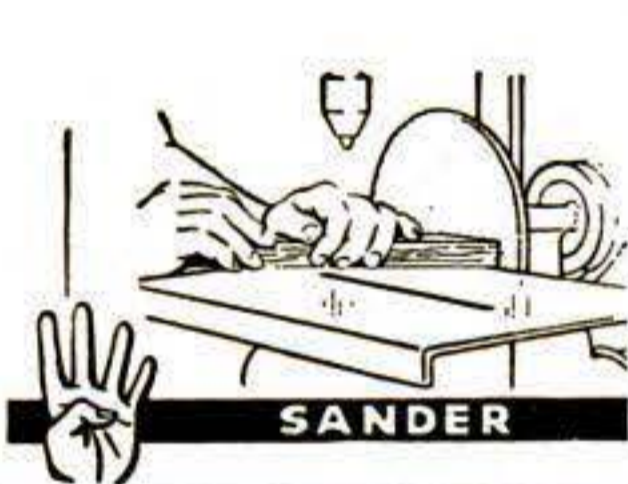

SANDER



GRINDER

Complete except for motor and saw blade.

SEND THIS COUPON NOW!

EMRICK, Inc. 1762 Clinton Street
Kalamazoo 24, Mich.

Ship on 10 Days Trial.
 I am enclosing \$17.50, balance
C.O.D. Send free literature.

Name _____

Address _____

City _____ State _____

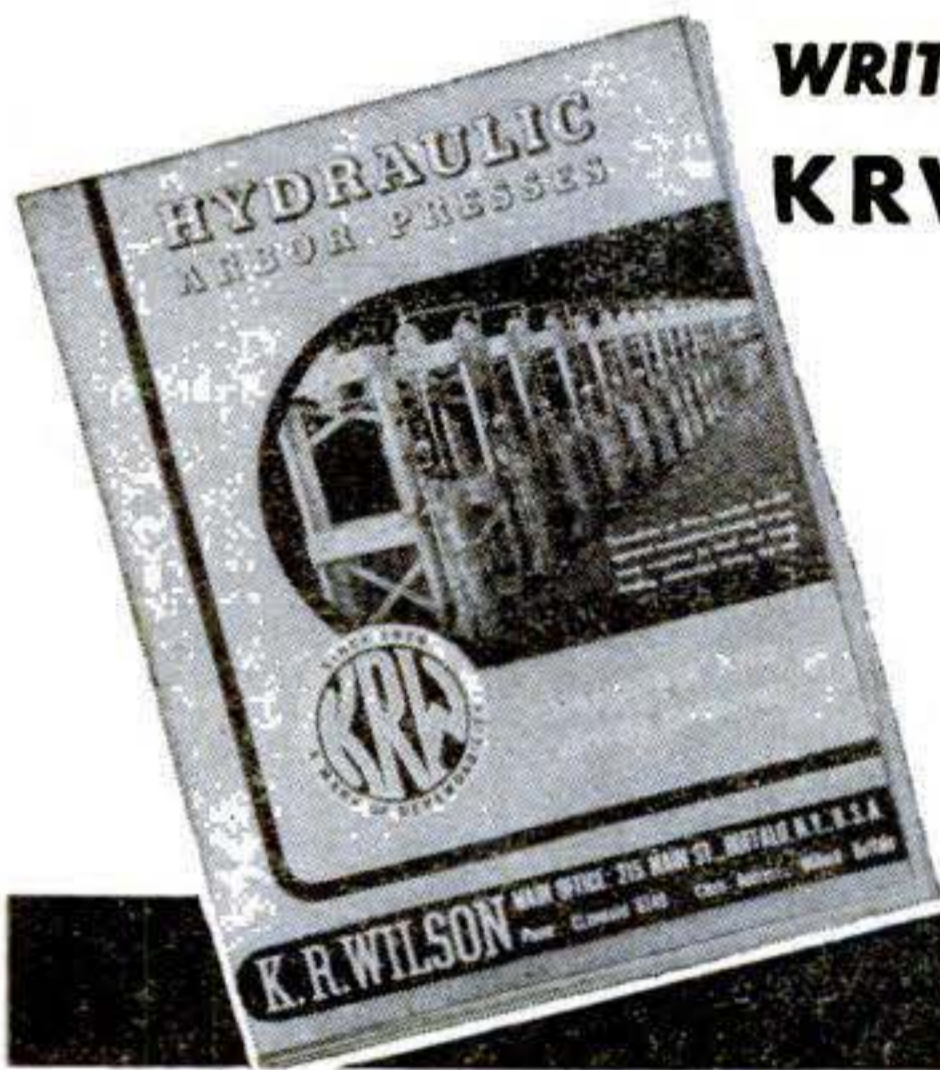

WRITE FOR YOUR **FREE** COPY OF THE NEW KRW HYDRAULIC PRESS BOOK

Describes all manner of Production and Shop Work on KRW Hydraulic and Bench Type Arbor Presses. 32 pages illustrating the new KRW Hand-operated, Electric-operated and Air-operated Hydraulic Presses. *Write for your copy today.*

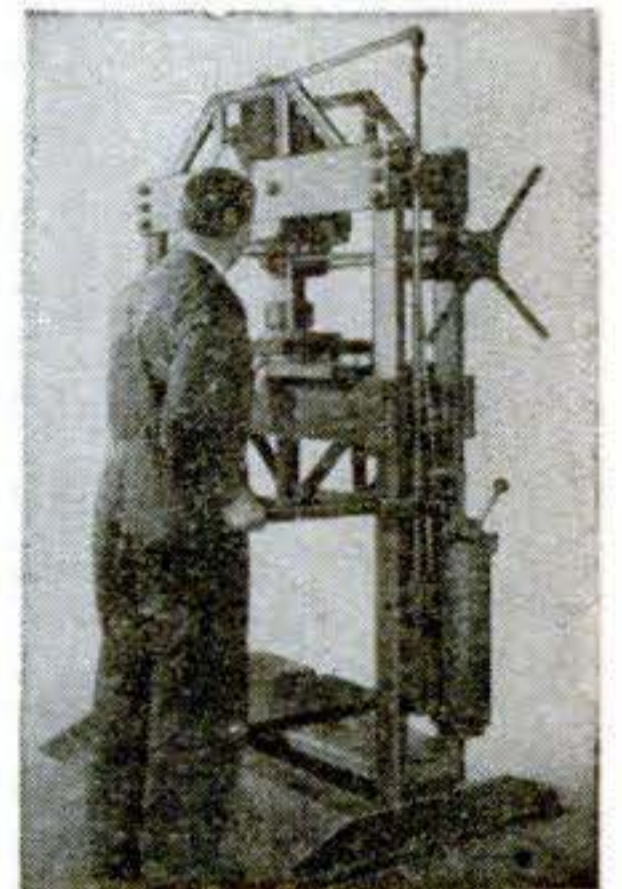

K. R. WILSON, DEPT. 54, 215 MAIN ST., BUFFALO 3, N. Y.

NEW LOW PRICE **\$44.45**

Available for Immediate Delivery

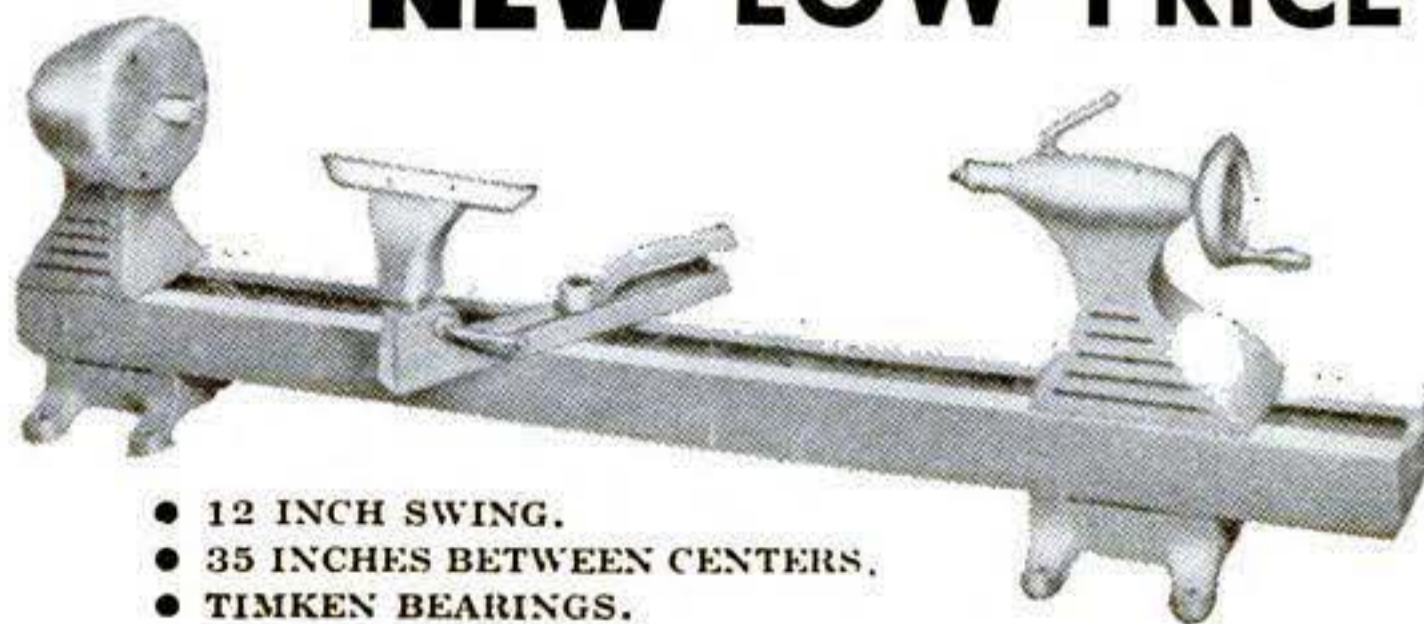

- 12 INCH SWING.
- 35 INCHES BETWEEN CENTERS.
- TIMKEN BEARINGS.

Round out your craftsmanship with this precision built woodturning lathe. To make many of those really fine pieces you've wanted for so long, you will need this tool. A 12 inch swing with 35 inches available between centers—a hard to find combination in a lathe at this price.—All Aluminum castings—won't rust; light in weight and always looks good in your shop.

If your dealer does not stock it—order direct. Please send money order or check with your order. Shipped freight prepaid.

ALBERT & J. M. ANDERSON MFG. CO., Dept. L, Boston 10, Mass.

AMERICA'S MOST
USEFUL ENGINE
The CLINTON

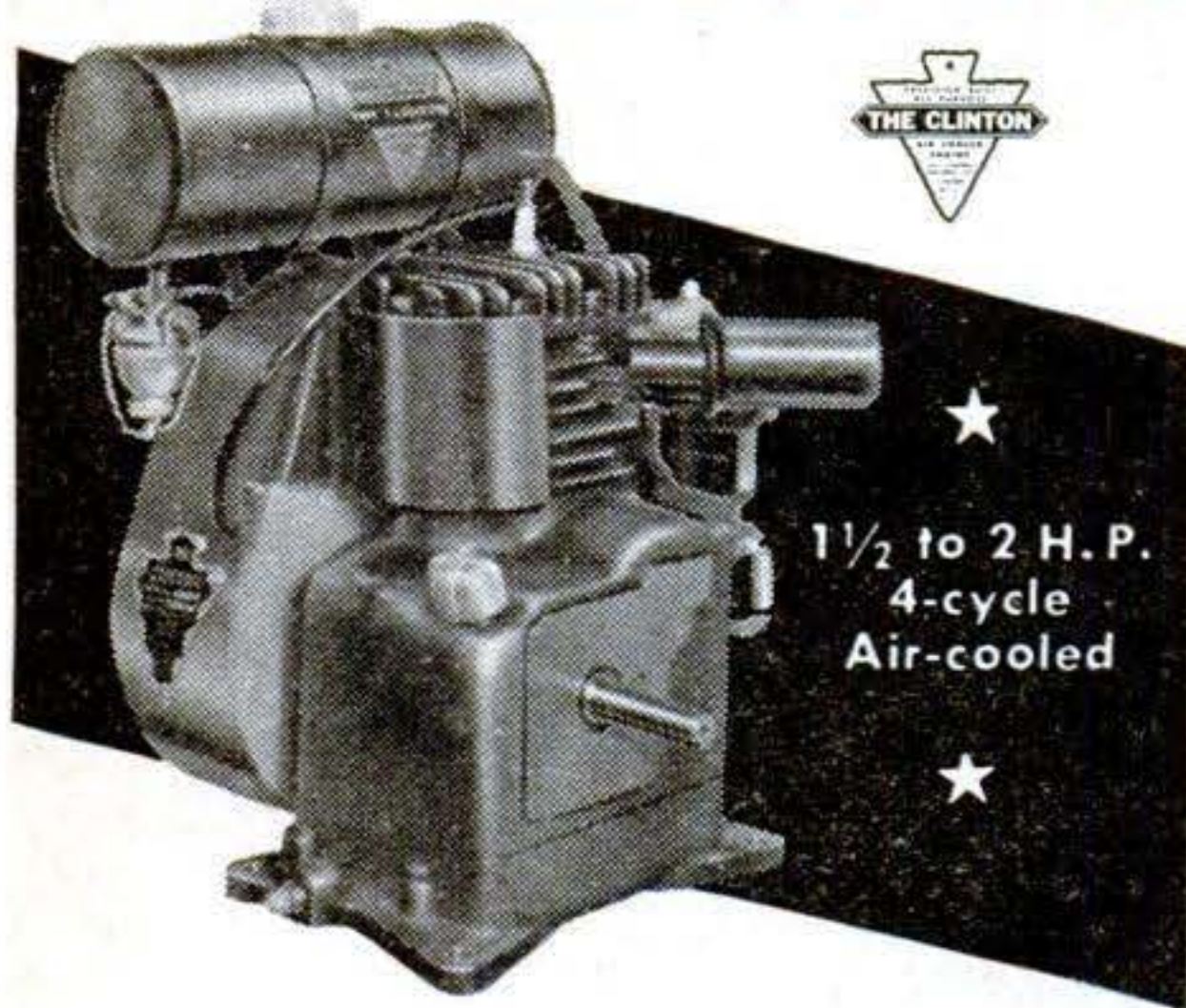

1 1/2 to 2 H.P.
4-cycle
Air-cooled

DEPENDABLE POWER

The engine preferred for powering lawn mowers — scooters — tractors — bikes — boats — concrete mixers, etc. Built by the world's largest manufacturer specializing in 1 1/2 to 2 H. P. Gasoline Engines.

Write for information Box 101 PS

★ **CLINTON MACHINE CO.** ★
CLINTON, MICHIGAN

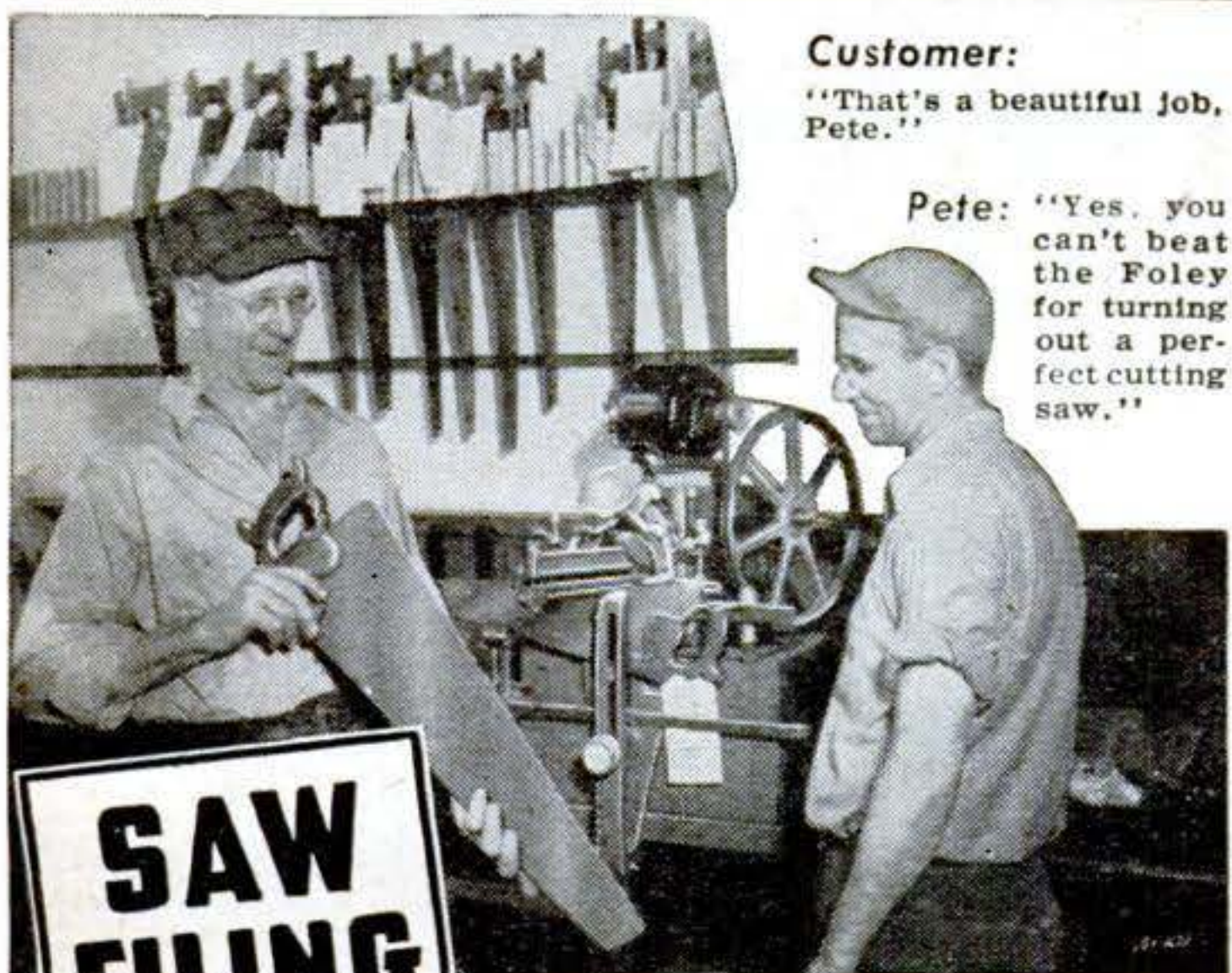

Customer:
"That's a beautiful job, Pete."

Pete: "Yes, you can't beat the Foley for turning out a perfect cutting saw."

**SAW
FILING**

is a Good Business

With the Foley Automatic Saw Filer you can put yourself into a fine cash business with steady customers and make a good living. The Foley automatically joints the saw, making all teeth even in size, shape, spacing. The Foley is the only machine that files all hand saws, also band and cross-cut circular saws. **IMMEDIATE DELIVERY** on a Foley Saw Filer! Free Plan shows how to start—mail coupon today.



FOLEY Automatic SAW FILER

FOLEY MANUFACTURING CO.
1219-7 Foley Bldg., Minneapolis 18, Minnesota
Send Free Plan on Saw Filing business, no obligation

Name _____
Address _____

CROSMAN Silent RIFLE



**POWER
without POWDER**

You'll like a Crosman because there is no recoil to spoil your aim...no noise...no odor...no cleaning! Rifled barrel for greater accuracy...adjustable power, too, for short or long range shooting indoors or out. Available in .177 and .22 cal. models. **AT YOUR DEALER OR WRITE DIRECT**

CROSMAN ARMS CO., INC.
9E HENRIETTA ST., ROCHESTER 7, N. Y.

Shoot CROSMAN SuperPells

The BETTER Ammunition for ALL .177 and .22 caliber Air Pistols and Rifles.



.177 cal... \$2.50 per M
.22 cal... \$3.00 per M

**FOR
GREATER
ACCURACY
MAXIMUM
POWER**

POSTAGE PREPAID
At your dealer or order direct

CROSMAN ARMS CO. HENRIETTA ST., ROCHESTER 7, N. Y.

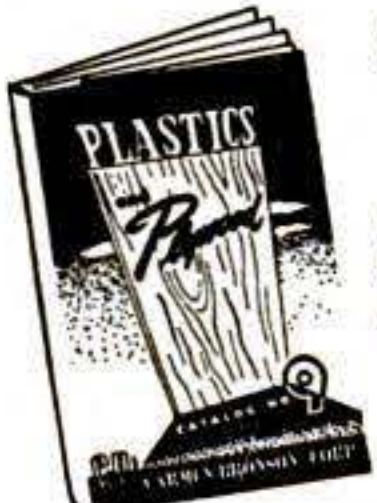

CRAFTSMEN . . .

We offer you hundreds of craft materials, supplies and accessories:
• PLASTICS • POWER TOOLS • PLYWOODS
• PLASTIC LEATHERS • JEWELRY FINDINGS
• MARINE PLYWOOD • BOAT KITS

Send 10¢ today for latest big 64-page illustrated catalog.

CARMEN-BRONSON CORP.
162 So. Fulton Ave., Dept. DS-1, Mount Vernon, N. Y.

**FOR SAFER DRIVING IN STORMS AHEAD
ASK YOUR GAS PUMP MAN TO PUT ON FOR YOU**

New "DEAD-LOCKER" Models
ANCO RAIN-MASTER
Windshield Wiper Arms and Blades

Made in U. S. A. by
THE ANDERSON COMPANY GARY, INDIANA

FREE!
FAMOUS
BLUE BOOK
CATALOG

GAME SUPPLIES

Club Furniture - Counter Games - Punchboards - Magic Cards Readers, Read the backs - Inks - Daubs - Poker Chips - Tops Flats - Layouts - Game Boxes.



K.C. CARD CO., 838 South Wabash Ave., Chicago 5, Ill.

To prevent summer **MILDEW \$1.00**

Start NOW using **MIL-DONT** POSTPAID

Send for special **CHRISTMAS OFFER**
4 oz. of concentrate will make 15 Gal. of treating solution. Spray, Swab, or Dip. Protect leather, clothing, rugs, etc., from ravages of microorganisms. Also deodorizes by killing odor forming microbes. **DISTRIBUTORS** needed. Many territories open. Write **MYCY 204 Arbor St., Cranford, N.J.**

NONE BETTER! **SUPER DRILL GRINDER**

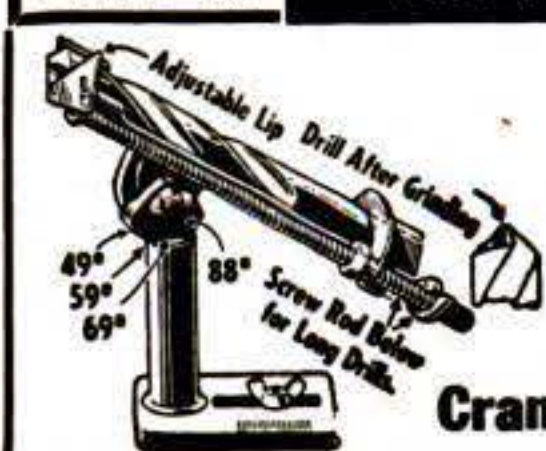

Sharpens round shank drills from 3/32" to 1 1/16" in diameter, up to 11" long. Grinds old drills like new in 4 different point angles, using hand or power grinding wheels. Money-back guarantee.

Price only **\$2.95**
At Dealers or Postpaid
Crandall Mfg. Co. 1512 W. Slauson, Dept. FB-24 Los Angeles 44, Calif.

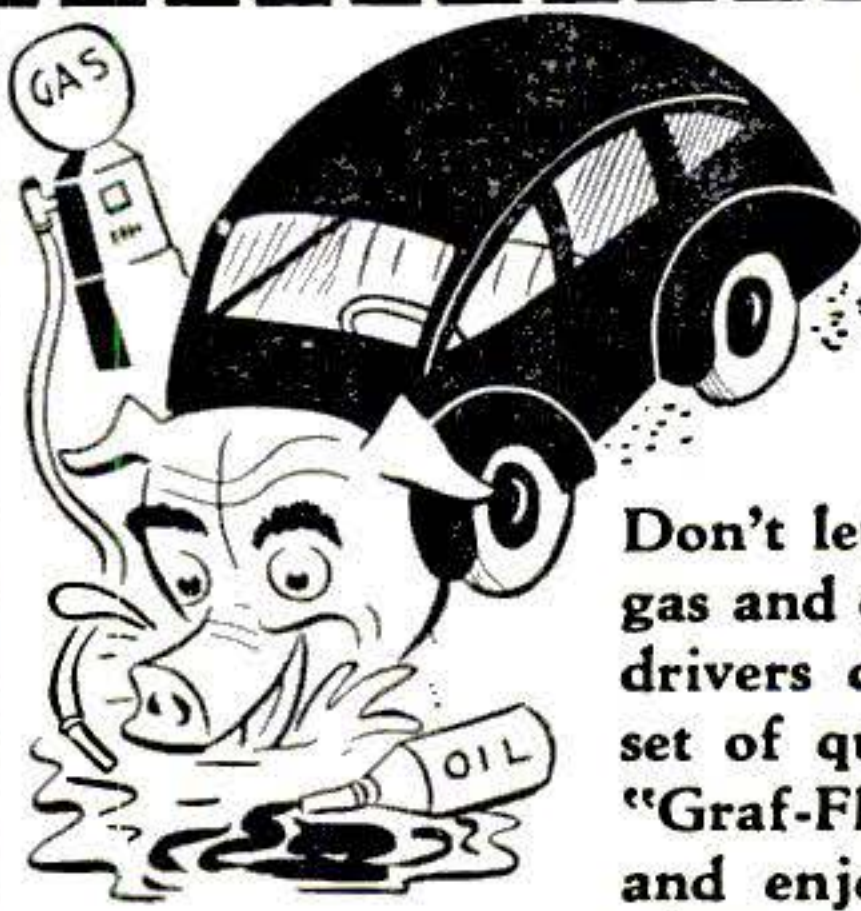

IS YOUR CAR A HOG?

Don't let your car "hog" gas and oil! Do what race drivers do . . . install a set of quick-seating Burd "Graf-Flox" Piston Rings and enjoy fuel economy plus pep and power!

Two free, handy booklets for car-owners are yours for the asking. Just print your name and address in the margin, alongside this ad, clip and mail today.



BURD PISTON RING CO., DEPT. PS., ROCKFORD, ILL.

60 POWER TELESCOPE \$2.95

VARIABLE EYEPIECE 20X-40X-60X

NEW! Three telescopes in one, 3 different magnifications. 20 power for ultra-bright images with 40 and 60 power for extra long range. Guaranteed to bring distant objects, people, sports events, ships, moon, stars, etc., 60 times as close.



Most powerful for anywhere near the money. 5 sections. Closes to 1 ft. long. Contains 4 ground and polished lenses. Also used as a powerful compound microscope. Directions included. Mass production enables us to offer this high-powered instrument at the amazing price of only \$2.95. We pay the postage. Get yours immediately.

BROWSCOPE CO.

Dept. 12P 24 West 45 St. New York 19, N. Y.

LAW

STUDY AT HOME for PERSONAL SUCCESS and LARGER EARNINGS. 39 years expert instruction—over 108,000 students enrolled. LL.B. Degree awarded. All texts furnished. Easy payments. G.I. Approved. Send for FREE BOOK.

AMERICAN EXTENSION SCHOOL OF LAW
Dept. 84-S, 646 N. Michigan Ave., Chicago 11, Ill.

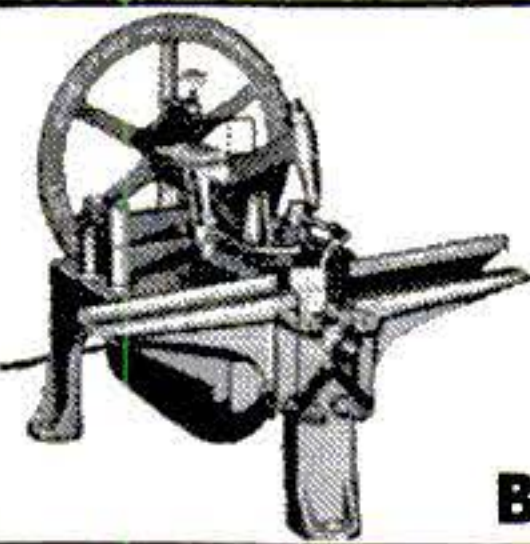

AUTOMATIC SAW SET

Set saw teeth automatically on hand or band saws—400 per minute without effort. Perfect hammer and anvil action sets teeth uniformly—No tooth breakage.



IMMEDIATE DELIVERY
WRITE TODAY

AUTOMATIC RETOOTH

Cuts new saw teeth in 50 seconds—any size 4 to 16 points. Old teeth fall off as chips. Easy to operate. A perfect job.

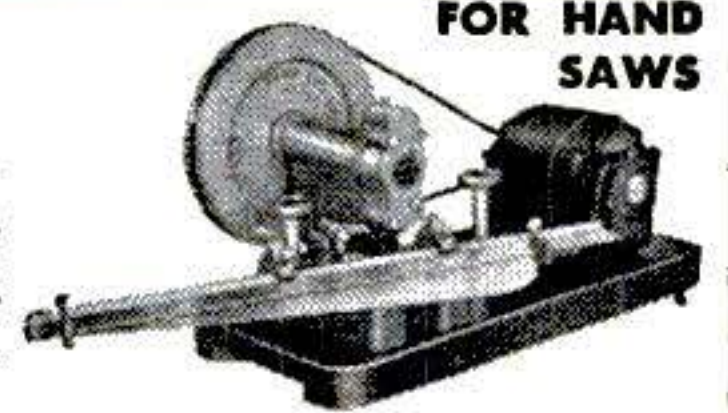

FOR HAND SAWS

BURR MFG. COMPANY, 8931-L Venice Blvd., Los Angeles 34, Calif.

Floor Model, \$79.50,
Shipping Wt.,
156 lbs.

QUALITY 8" TABLE MODEL TILT-ARBOR SAW

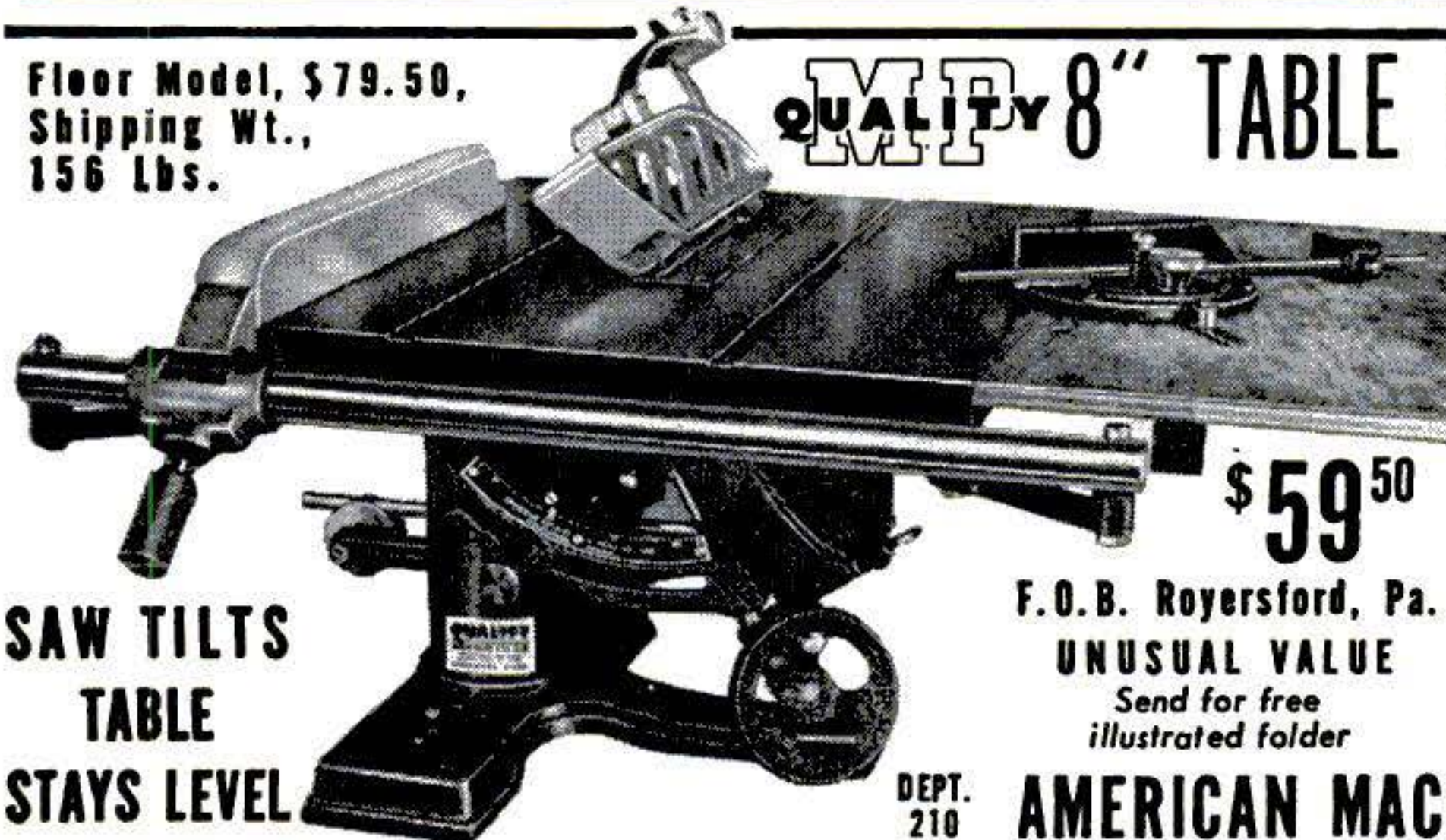

SAW TILTS
TABLE
STAYS LEVEL

\$59⁵⁰

F.O.B. Royersford, Pa.
UNUSUAL VALUE
Send for free
illustrated folder

DEPT.
210

AMERICAN MACHINE & TOOL CO., INC. Royersford, Pa.

UNCONDITIONALLY GUARANTEED 1 YEAR
Complete as shown with Trans-axial Ball Bearing Motor Drive, Ball Bearing Saw Arbor, Table including extension 18" x 25", Aluminum Fence & Saw Insert, Complete Mitre Gauge, Precision Segments on Mitre Gauge and Cradle. • Cast Iron table extension bracket furnished. Will support plywood top much larger than 9" x 18". Motor pulley and belt furnished. Blade and motor not included. SHIPPING WEIGHT 118 LBS.
IMMEDIATE DELIVERY



35 MILES PER GALLON

If you want real performance, choose CROSLLEY! This fine, new car reverses the trend toward heavy, cumbersome, expensive automobiles—weighs only about 1/3 as much and operates for about 1/2 as much as other so-called light cars.

W. G. Reynolds, Route 1, Springfield, Tenn., has driven his Crosley 15,000 miles with an average of 35 to 40 miles per gallon of gas.

And the new CROSLLEY truly IS a FINE car. In the convertible or sedan, you get ample room for 4 husky people plus luggage. You get smooth, safe, effortless driving.

In the 1/4 ton CROSLLEY PICKUP, you get real economy for service calls, light deliveries, etc.

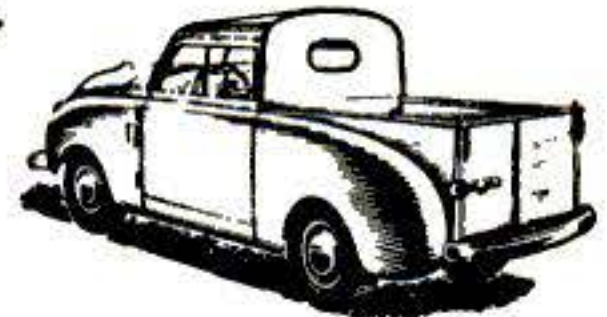

In every CROSLLEY you get the startling COBRA (Copper BRAzed) steel engine with 7 1/2 to 1 ratio; delivers 35 to 50 miles per gallon—care-free cruising—lightning pickup.



a FINE car

For information and literature write: Crosley Motors,
2532 JG Spring Grove Ave., Cincinnati 14, Ohio

**A SURE CURE
FOR
Home-
Budget
HEADACHES...**

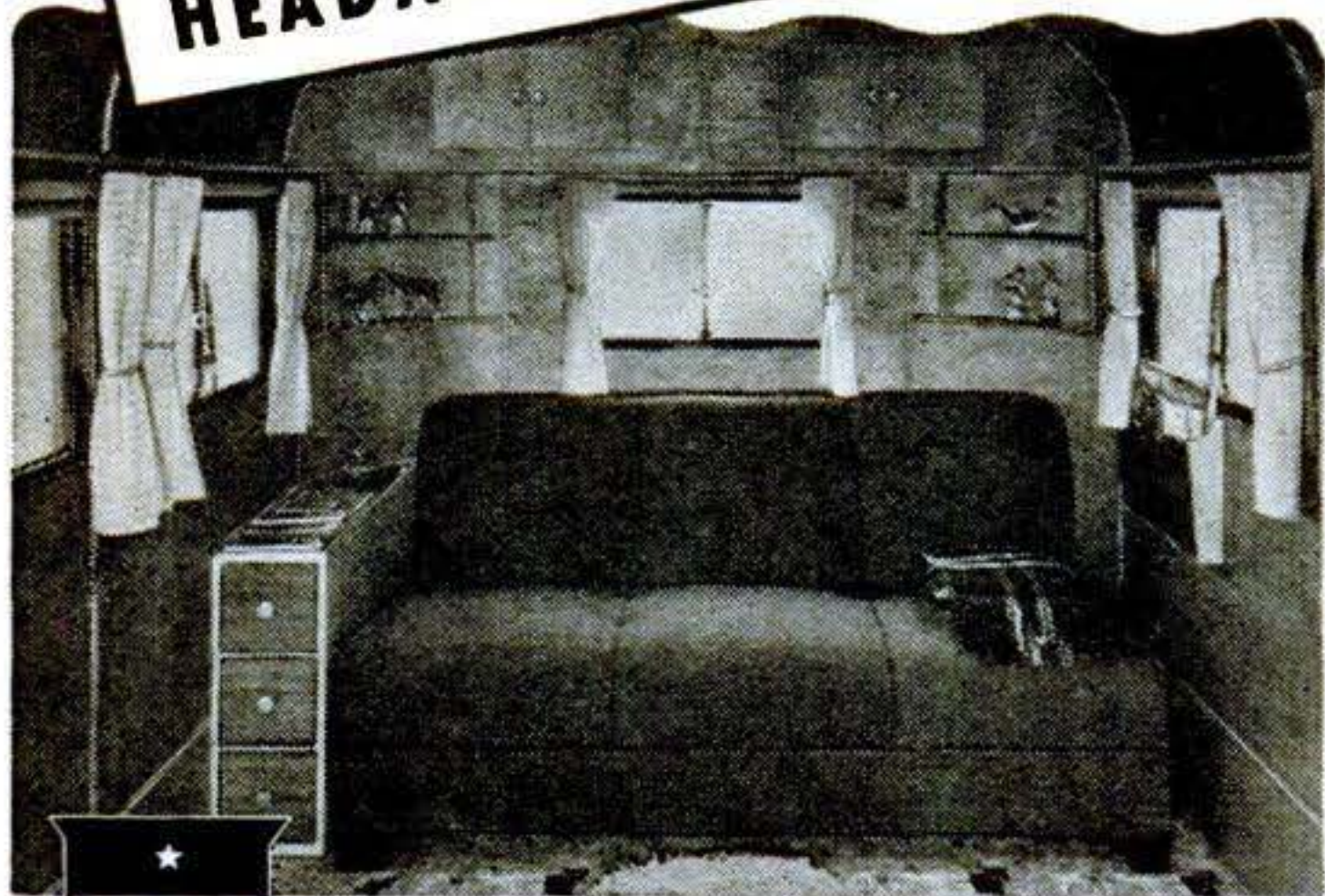

own a **SCHULT!**

Move into a Schult and you have an equipped, 3-room home wherever you go. Your investment in this quality product is backed by a decade of preference... for design, performance, and high trade-in value. **WRITE TODAY** for illustrated catalog and the name of the Schult dealer nearest you.



SCHULT CORPORATION
Dept. 3112, Elkhart, Indiana
In Canada: John Inglis Co., Ltd., Toronto

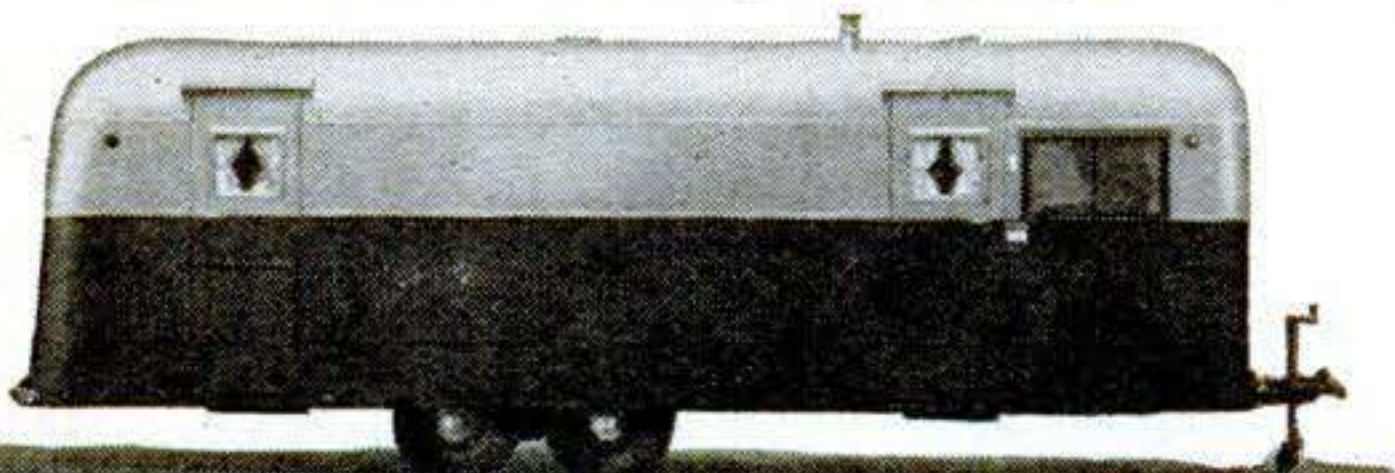

SCHULT *Trailer Coaches*

KAYAKS
AQUA VIR
Easy to Build
**OUTBOARDS
ROWBOATS**

**BOATS for
Home Assembly**
"U-MAK-IT"
KAYAKS, ROWBOATS, DINGHIES,
INBOARDS, OUTBOARDS, RUNABOUTS
Cut-To-Fit for Quick Assembly. Everything
Complete plus Illustrated Instructions. No Ex-
perience Necessary. Simple as A. B. C.

25¢ COIN
FOR ALL
THREE

AQUAMOBILE V-18
Designed for Auto Engines. Open or
with cab. Length 18 ft.
Fast VEE Bottom Hull.

SEND 25c POSTAGE (COIN) TODAY
FOR 3 MONEY SAVING ILLUS. CATALOGS
Showing all '48 Models (marine plywood)
and construction details.

KAYAK BOAT CO., 703R-WHITTIER ST., N.Y. 59, N.Y.



**Saves Time, Effort, Money in
APPLIANCE REPAIRING!**

New Model '60' checks all appliances. AC
ammeter range 0-15 Amp. Serves as wattmeter.
High sensitivity neon tube. Checks thermo-
stats. Tells instant it cuts in or out. Is all
'round trouble shooter. Only \$14.50 complete.

FREE with each tester. New Complete Practical
Course in electrical appliance repairing.
Write for circular.

HANLAN CO., 1419-B, West Jefferson, Los Angeles 7, Calif.

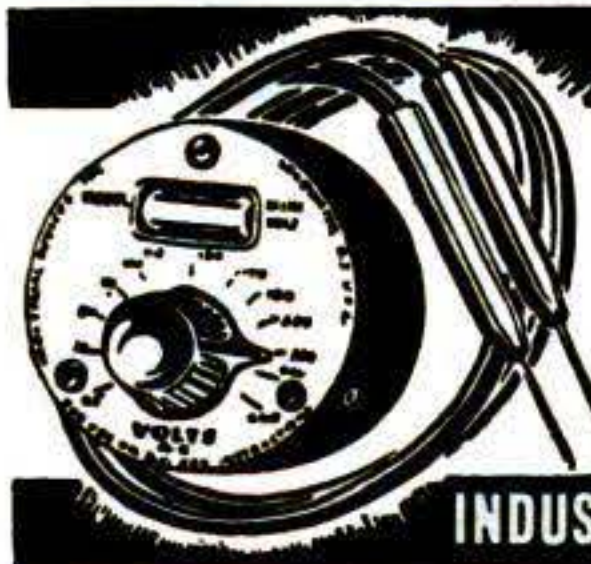

FLASH THAT VOLTAGE

Turn that knob. Extinguish the neon
glow. Instantly read voltage right off
dial. MINI-VOLT measures 65 to 660 v.
AC. Also DC. Tells whether AC or DC.
Virtually burnout-proof. Guaranteed for
10,000 hours' operation. Bakelite case.
12" flexible test leads and test prods.
A "must" in electrical and radio work.
Model 400B only \$2.50 postpaid!

INDUSTRIAL DEVICES, INC., EDGEWATER, N. J.

**Say You Saw
It In Popular Science**

NEWEST OTTAWA LOG SAW

**SELF-PROPELLED - MOVES
ANYWHERE on OWN POWER**

World's fastest Log Saw. Pow-
erful 6 H-P air-cooled motor.
Attachments for sawing down trees,
buzzing limbs, post hole digging and pulley for belt jobs. Big
demand for wood, pulp, posts. Make big money sawing wood this
easy way. Low factory-to-user prices. Nothing like it. **FREE** details.
OTTAWA MFG. CO., 7-701 Pine St., Ottawa, Kansas



The Chief **WORK BENCH**

Built to Last a Lifetime!

With Bottom Shelf and 18" Sq. Drawer. 2"x6", Solid Plank, Grooved and
Dovetailed Top and 1"x8" Back Rail, Shellacked to a Smooth. Satiny Finish.

MOHAWK LUMBER CO. Dept. 34
14525 W. Chicago Blvd. Detroit 27, Mich.
Enclosed Check Money Order for \$.....
Ship..... **CHIEF WORK BENCHES** at
Quantity.....
\$16.95 each, F.O.B. Detroit, Mich.
 Send C.O.D., \$5 Deposit Enclosed.

NAME.....
ADDRESS.....
CITY..... STATE.....
No Priority Necessary!

• 6 Ft. Long • 34" High • 26"
Deep. Shipped Knock-down, with
Bolts, Nuts and Screws and ABC
Chart for Quick, Simple Assembly.
Prompt Delivery
MOHAWK LUMBER CO.
14525 W. Chicago Boulevard
DETROIT 27, MICHIGAN

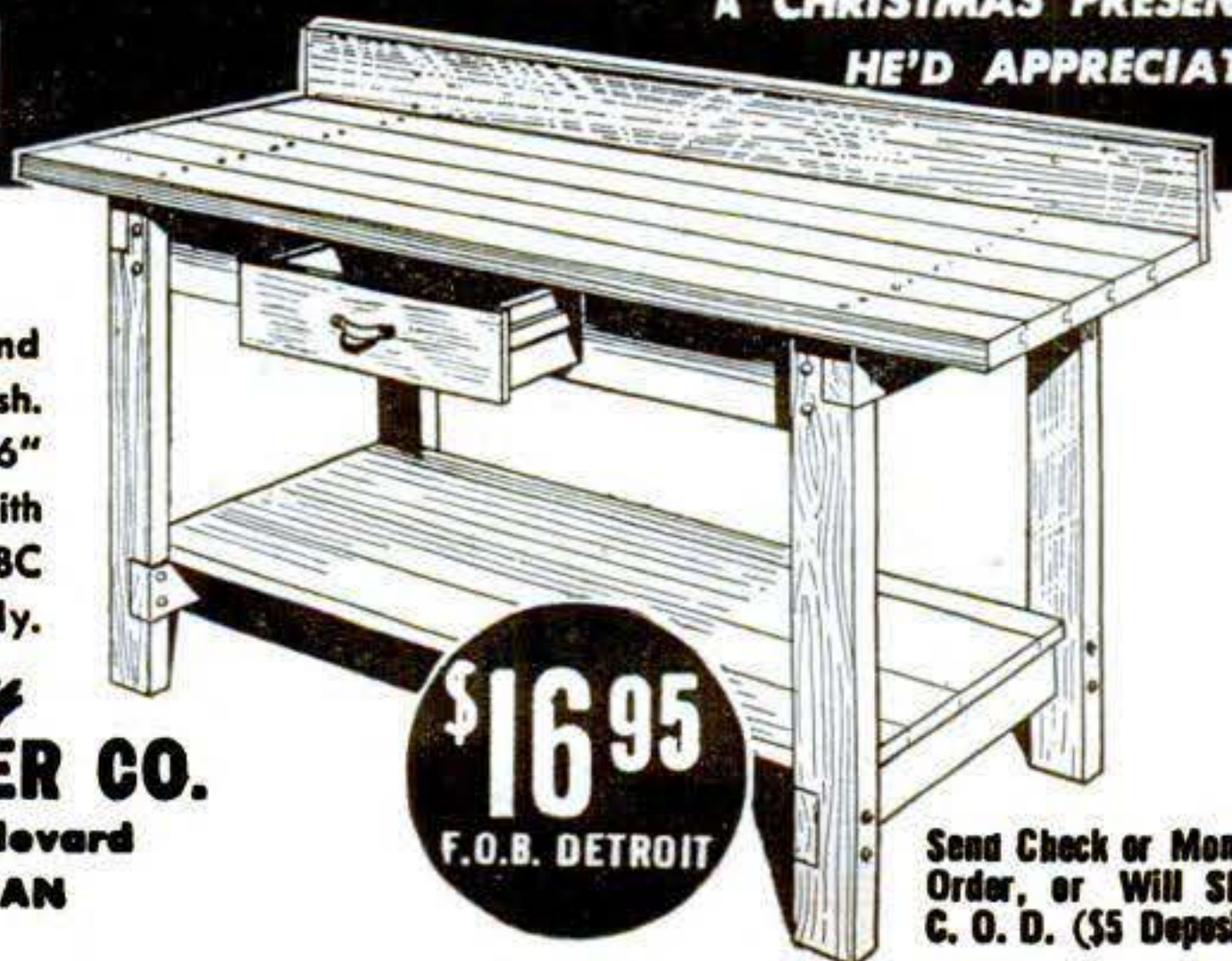

**A CHRISTMAS PRESENT
HE'D APPRECIATE**

\$16.95
F.O.B. DETROIT

Send Check or Money
Order, or Will Ship
C. O. D. (\$5 Deposit)

QUICK PROFITS!

\$84.00
A WEEK FROM
2 SALES A DAY

SELL RANDOLPH Fire Extinguishers

NEW...
MODERN...
APPROVED..



Every building holds a prospect. Homes, Boats, Cars, Garages, Gas Stations, Shops, Laundries, Farms, Hotels, Stores, Factories.

THEY WANT A RANDOLPH with its panic-proof trigger action that smothers the fire instantly in a snowy blanket of carbon dioxide. No mess, no water, no damage, even to food. It evaporates without a trace.

YOU CAN QUALIFY for exclusive territory to sell the famous, nationally advertised Randolph used by leading industrial concerns everywhere. Approved by Underwriters' Laboratories.

Quick profits await those who act at once. Four sales a day net \$168.00 a week. Write today for full or part-time plan, territories, demonstration kit, etc. Don't delay.

Randolph Laboratories, Inc.
4 EAST KINZIE ST. CHICAGO 11, ILLINOIS, U. S. A.

The Flex-O-Shaft TOOL KIT

HANDLES LIKE A PEN*

A new improved, all-purpose machine for use in home or shop. Slender, light-weight aluminum hand piece is ideal for grinding, drilling, sawing, buffing, scoring, etching, polishing, etc. No bulky, throbbing, pulling motor in your hand. Light-weight motor can be hung on wall. Speed is controlled by a foot-operated rheostat, leaving hands free. This precision, ball-bearing tool is as easily guided as a pencil. A wonderful, compact power house for making all kinds of objects. Handy for school shops and factories.

Save \$10.00

1/16 H.P. motor, cord and Flex-O-Shaft....\$27.50
Foot-operated rheostat, long cord and plug 8.50
Sixty-six accessories 16.50
Separate items 52.50
Complete Tool Kit only..... 42.50

Men will appreciate this unique Tool Kit as a Christmas gift.

Flex-O-Shaft Sales Co. (Dept. D)
Prairieview, Illinois

() Please send complete information on the Flex-O-Shaft Kit.
() Please send one Flex-O-Shaft Kit, \$42.50 enclosed. Shipping charges C.O.D.

Name.....
Address.....
City.....Zone...State.....



The HOME CHEMIST



A new book which shows how to set up and operate an inexpensive home laboratory with odds and ends of material available in every home. Many thrilling, practical, useful experiments and tests, entertaining, instructive, valuable, pointing the way to research and new discoveries. Many diagrams and illustrations. Full cloth bound \$1.49.

POPULAR SCIENCE MONTHLY, Dept. 127
353 Fourth Ave. New York, N. Y.

Aladdin's Tool

THE "GENI" OF A THOUSAND AND ONE USES !!!

Tongue & Groove - Fluting - Notching - Inlay - Any Joint



Complete With 6 Ground Blades - And New Adaptor

Makes 12 Different Cuts

Makes any cut wood shaping tools costing up to \$300.00 can make—more too. Sturdily built, lasts a lifetime. Complete—makes 12 standard cuts and over 100 variation shapes. See your dealer or if he does not stock, send \$7.95 for immediate delivery to your door. All other orders C. O. D. plus postage.

\$7.95

Dealers Write for Information



All Types Of Wood Shaping

The Design Co., 531 Scarritt Bldg., Dept. D14, Kansas City 6, Mo.

Gift Suggestions FOR HOBBYISTS



MULTI-PURPOSE WOOD PLANER

Fits any drill press. Exclusive hi-speed blade design performs precision surface planing, rabbeting, tenoning, paneling, grooving, routing beading. Thousands now in home workshops, schools, cabinet and pattern shops. An indispensable lifetime tool for wood and plastic workers. Complete **\$7.50**



NEW STYLE DRUM SANDER

Fits any 1/2" drill press chuck. Used for sanding curves, contours, straight edges. Has many essential workshop applications. Complete with 5 spiral sanding sleeves..... **\$3.95**

4" ROTARY SURFACE SANDER

An exclusive type sander for drill presses, flexible shafts, motors, hand drills. Instantly sands woods, plastics and metals to agate smoothness. No waves, ripples, striations. Discs immediately interchangeable. With 20 discs... **\$5.95**



ALL METAL SHAPER FENCE

Precision built of hard alloy aluminum and steel. Nothing to rust. No wooden parts to warp. For moulding, jointing, shaping, rabbeting, tenoning. Fits all standard drill presses—shapers. Complete with two hold down springs. A real buy at **\$7.95**



AT YOUR DEALER—OR ORDER DIRECT
FREE Workshop Catalog
BARRON TOOL COMPANY, INC.
270 Architects Bldg., Detroit 1, Mich.



BARRON PRECISION WORK SHOP TOOLS

WORLD'S FASTEST VISE



HEINRICH

Grip-Master
DRILL PRESS TYPE
SCREWLESS VISE

NATIONAL MACHINE TOOL CO., DEPT. 227-M, RACINE, WIS.

The new Heinrich "Grip-Master" is a **SCREWLESS** vise. Operates effortlessly . . . avoids tiresome winding . . . saves time. Movable jaw adjusted in a jiffy . . . locked securely by easy press on locking lever. Design permits drilling clear thru work. Jaws have built-in parallels . . . extra loading capacity. Bars and locking mechanism hardened and ground. The "Grip-Master" is the most revolutionary advancement in 100 years of vise manufacture.

MONEY BACK GUARANTEE

If your dealer does not have the "Grip-Master", we will ship express prepaid for cash with order. Model 3-SV (3" jaw), \$16.50; 4-SV (4" jaw), \$27.50. Larger sizes also available. Folder on request.

Just Out! New CONCORD RADIO Catalog



The ONLY Complete Up-to-the-minute Catalog of RADIO PARTS • RADIO SETS KITS • HAM GEAR • TESTERS

The greatest, latest complete presentation of radio, electronic and television equipment and supplies in Concord history! Packed from cover to cover with thousands of items—160 pages of everything in Radio and Electronics. Special bargain section of hundreds of money-saving values. Scores of new items from famous makers. Parts, blue-

prints for famous Popular Mechanic and many other kits. Write for your **FREE** copy. Please address Dept. PS-127.

CONCORD RADIO CORP.

LAFAYETTE RADIO CORPORATION

CHICAGO 7

901 W. Jackson Blvd.

ATLANTA 3

265 Peachtree Street

BUILD Boucher MODELS

CLIPPER TANKER FREIGHTER
Everything for the Model Ship Builder Since 1905

44 Different Model Kits

\$3.50 to \$42.50

Send 30c for 64 Page Illustrated Catalogue

BOUCHER SHIP MODELS 36 EAST 12TH ST., NEW YORK, 3, N.Y.

AIRCRAFT SUPERCHARGER LUBE PUMP

Designed for pumping liquids up to 3 G.P.M.

A gear type impeller pump with two pumping units in one housing. Precision built of aluminum, cast iron, bronze and steel. Compact construction—only 3 1/2" Dia. x 8 1/2" long.

- Vacuum, 29 1/2 inches of mercury.
- 1/2" Dia. Threaded and keyed shaft.
- Brand new! Sealed in Pliofilm.
- With Test Sheet and Instructions.

Immediate delivery. Order now! Post paid anywhere in U.S.A. upon receipt of check or M. O. C.O.D. orders include postage and extra fees.



Pressures up to 200 lbs. per Sq. In.

From 1 to 3900 R.P.M.

Originally cost \$24.00. Now only

\$3.95

FISCHER LABS 1729 N. MOBILE, CHICAGO, 39, ILL.

HY-ARC "4-PURPOSE" WELDER

IT WELDS • IT BRAZES • IT SOLDERS • IT HEATS
AT A SENSATIONALLY LOW PRICE OF ONLY

Ideal for Home • Shop • Farm • Machinists • Auto • General Repair • Plumbers • Electricians, Etc. **\$19.95**

Radical in construction and design. Successfully used on ships . . . in the field . . . and shops. Works on AC or DC 110 volts. Sold on money-back guarantee. Return set if dissatisfied in 10 days. Send check, money order or \$5 deposit. Pay postman \$14.95 balance plus small postage charge. Welder sent postpaid if you send check or money order for \$19.95 with order.

HERE'S WHAT YOU GET WITH THIS OUTFIT!

Set consists of power unit; all metal case, heavy duty carbon arc torch (also to be used as metallic arc electrode holder and ground); also Extra Special welding helmet with unbreakable lens; 1 asbestos block; brazing flux; cast iron flux; ample supply of metallic arc rods; aluminum rods; brazing rods; cast iron rods; copper coated carbons; 6 ft. primary cable; 2 secondary cables with plugs and insulators; complete instruction book. Send in order today.

HY-ARC MFG. CO. Dept. PS 12
6859 So. Anthony Av., Chicago 37 Illinois.



Amazing **NEW!**
 ● SHAPER
 ● PLANER
 ● SANDER

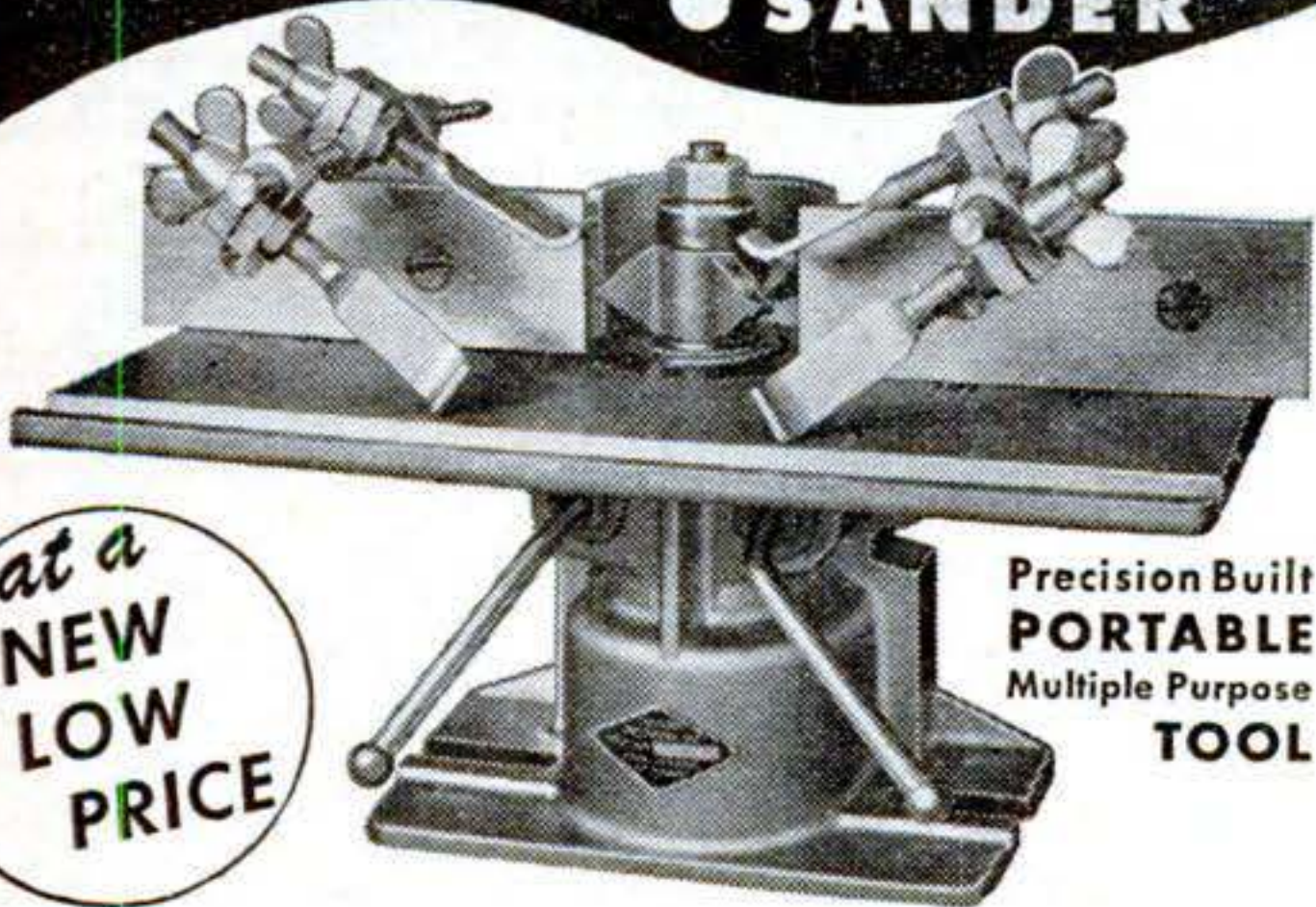

at a **NEW LOW PRICE**

Precision Built **PORTABLE** Multiple Purpose **TOOL**

For The Home Workshop Or On The Job

Here is THE precision tool that every man who works with wood just can't afford to be without. The REDFORD is a shaper, planer, sander—all in one—at a price never before thought possible. It is portable (weighs only 12½ pounds) takes any standard cutter, planer or sander that fits a 1/2-inch spindle. Power-driven from a 1/3 H.P. electric motor (not furnished) or it may be bolted to a drill press table and driven direct from drill press chuck.

Illustrated folder explains in detail ALL of the many NEW FEATURES and advantages. Nothing else compares with its versatility—or LOW COST.

Send for **FREE** Illustrated **FOLDER**

DON'T WAIT—WRITE TODAY

REDFORD SPECIALTIES INC.
 18437 Salem • Detroit 19, Mich.

Assemble KING MIDGET



Practical highway racer runabout. We supply all parts. Just bolt together. Low cost. Ready for delivery NOW. One or two cylinder 40 m.p.h., 45 to 50 on ice or snow with skis, up to 100 miles per gallon. Send 25c for complete literature with large picture, 4-view drawings, price of parts, or send \$1 (refunded with first order) for the above, plus 24-page assembly book with 42 photographs and drawings; blueprints for converting for use on ice and snow, etc.

MIDGET MOTORS Athens, Ohio

"MAKES ARITHMETIC INTERESTING"



The AMAZING CHINESE ABACUS which a Japanese contestant used in Tokyo to outspeed the Electric Calculator! Now made in the U. S. A. with complete instructions. Naturally! LOY'S IMPROVED ABACUS is easier to use and more accurate to calculate than the old Chinese Abacus. Easy to add, subtract, multiply, and divide without using paper and pencil.

Use it at the store for all calculations . . . adding, checking bills and bookkeeping. Use it at home to make arithmetic more interesting for your children. The beautifully finished Abacus and specially illustrated book all for \$8.50.

Send for yours today with money order or C.O.D.

LOY'S CHINESE CALCULATOR

1317 Rhode Island Ave., N.E. Washington 18, D. C.
 Attention retailers: be the first in your community to sell this sensational item.

ELECTRIC MOTORS AIR COMPRESSORS

Guaranteed capacitor ball bearing heavy duty motors, 110/220 volts
 60 CYCLE AC SINGLE PHASE
 1725 RPM.

- 1/4 HP\$24.00
Wt. 30 lbs.
- 1/2 HP\$34.50
Wt. 36 lbs.
- 3/4 HP\$44.00
Wt. 50 lbs.
- 1 HP\$57.00
Wt. 80 lbs.

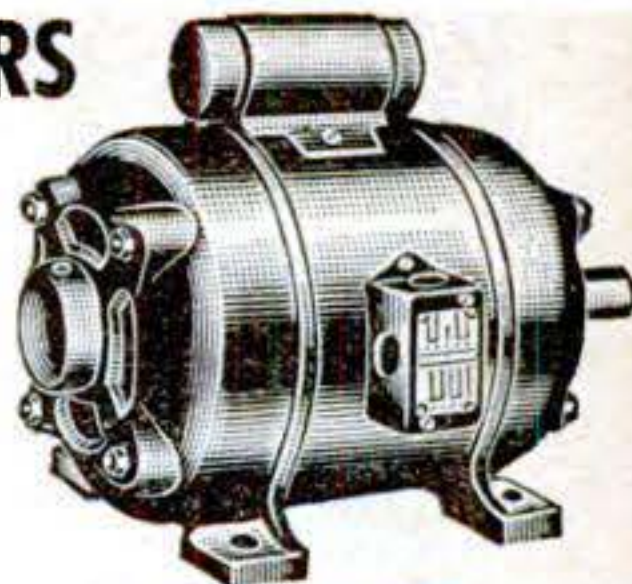

6 ft. Stow Flexible Shaft, Heavy Duty, 3/8" Core. Best piano wire. Ball bearing handle and arbor, rubber covered housing; for 1/2" motor shaft; for 1/2" bore wheels. Operates on 1/4 H.P. Motor at 1725 or 3150 R.P.M. \$29.00 Value, only \$16.50. Wt. 8 lbs.

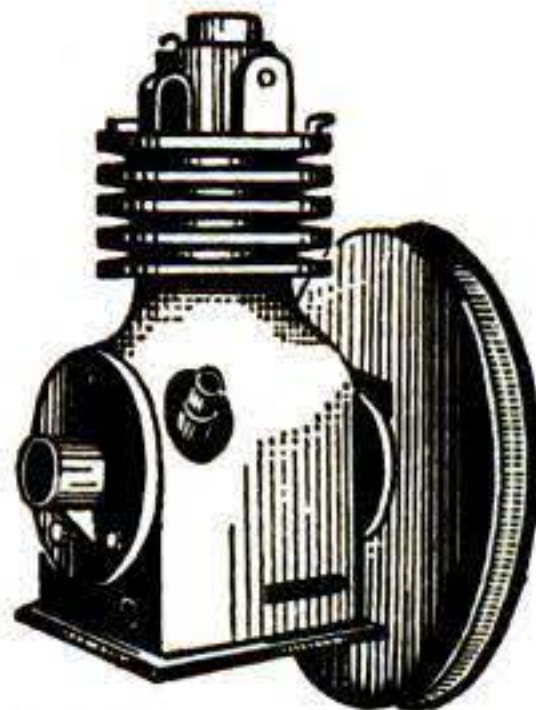

Air compressor, piston type, size 2 x 1 3/4, head in valves, bronze bearings splash lubrication. Capacity 2.8 c.f.m. at 100 lbs. continuous pressure or 150 lbs. intermittent, with 1/2 HP motor. Can be used with 1/4 HP or 1/3 HP at lower pressures. Price \$18.75. Wt. 24 lbs.



Special Price in Larger Lots

1/30 HP 24 volt DC motor 2450 RPM. 1/4" shaft. Price \$2.45. Wt. 4 lbs. Size 3" x 4". Write for special price in lots of 100 or more.

DELCO Light Plants

Portable 3 KW 110 volt DC with 6 HP Wisconsin or Briggs and Stratton air cooled engine. voltmeter with four outlets. 150 ft. rubber covered cord and plugs. Slightly used like new. \$375.00 value—special \$115.00. Wt. 350 lbs. crated.

500 Ingersoll-Rand riveters and chipping hammer. Model AVC-11, like new. Takes up to 5/32" rivet. \$66.00 list. Special price \$6.95. Wt. 5 lbs.



Prices quoted are F.O.B. Chicago, Illinois, offered for immediate delivery and shipment. We reserve the right to limit quantity. Send check or money order. Sold with money back guarantee.

C & M EQUIPMENT COMPANY

1831 S. STATE ST., DEPT. D-12

CHICAGO 16, ILL.

\$1

SOLID BRASS STEEL BLADES



4 in 1 SCREWDRIVER

Four different sized screwdrivers all fitted into one handy tool. Large enough for autos, small enough for watches. Dad and son will both want one. Mom will want these four vari-sized screwdrivers too for their many practical home uses. Also makes a good gift! Agents wanted, exclusive territory, liberal discount. Check or money order.

ELK MERCHANDISING CO., S12
 2348 N. Western Ave. Chicago 47, Ill.



LABORATORY MICROSCOPE 600 POWER \$22.50

3 Objectives—75X, 300X, 600X
 A professional type microscope priced within the reach of the amateur. For school, laboratory, physician, and student. Color corrected achromatic lenses. Professional size eyepiece and objective interchangeable with all standard professional makes. Height 14 inches. Weight 5 1/4 lbs. Stage 4"x4". 2 wheel focusing. Body tilts any angle. Microscope complete with 3 objectives, prepared specimen slide, and 96 page book on microscopy, only \$22.50.

We pay the postage. Immediate delivery. Money back guarantee.

BROWNSCOPE CO.

Dept. 12P, 24 West 45th St., New York 19, N. Y.

WORLD'S

LOWEST PRICED ADDING MACHINE

VEST POCKET SIZE

NEW!

Fits vest pocket or purse. Guaranteed accurate. Operated as easily, and as reliable, as machines costing many times as much. NOT A TOY OR GADGET. Precision made—very durable. Guaranteed for life against defects in construction. Beautiful looking, modernized design. Finished in silver with black numbers and red slides. You positively can't buy a Calculator of equal quality for as little money. ACCEPTED AS THE FINEST LOW PRICED CALCULATOR FOR OVER 35 YEARS! Now completely redesigned and improved. **BETTER THAN EVER BEFORE!** Operates with a flick of your finger. Adds, subtracts, multiplies, divides—counts up to one billion. Pays for itself over and over in mistakes avoided and time saved.

MAKES IDEAL GIFT

Baby Calculator makes an ideal gift—for every Gift occasion. Birthday — Graduation — Christmas — Anniversaries. For men, women, children, teachers, business people, home or shop use. **COMES PACKED READY FOR GIFT WRAPPING.**

TEN DAY TRIAL

Money Back Guarantee

Because we know that our machine is the very best Calculator to be obtained at this low price, we make this 10 Day Trial Offer on a positive money back guarantee! Don't buy ANY Calculator without this guarantee! Send only name and address, pay postman \$2.95 plus postage (if cash is sent, we pay postage—you save up to 40c). (Send full cash if outside U. S.) Money back within 10 days if not delighted.



IDEAL XMAS GIFT

FREE TRIAL

ONLY **\$2.95**
TOTAL COST

SEND NO MONEY

FREE!!

Each Baby Calculator enclosed in beautiful, rich-looking simulated Leather Case—at no extra cost.

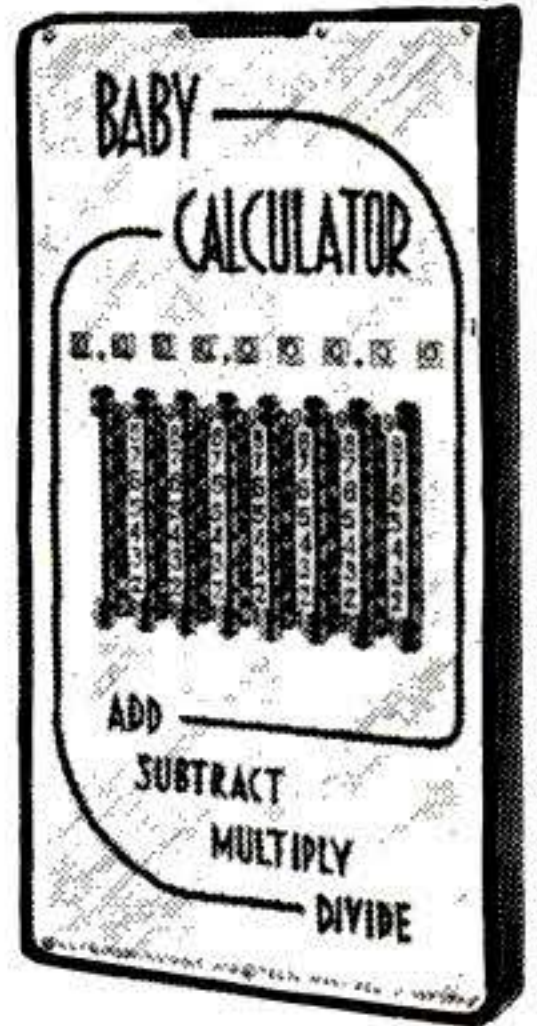

CALCULATOR MACHINE CO. (Mfrs.)

Dept. 485, P. O. Box 248, GLENVIEW, ILL.

AGENTS WANTED

USE COUPON

CALCULATOR MACHINE CO., (Mfrs.)

Dept. 485, P. O. Box 248, Glenview, Ill.

Your Calculator is just what I've been looking for. Send one at once (C.O.D.) or (I am enclosing \$2.95).

Name.....

Address.....

City.....State.....

NEW PLASTICS FUN KIT

HERE is your package of Christmas fun—hours of enjoyment building beautiful plastic jewelry, novelties and household articles! **FUN KIT** gives you everything you need to build 8 attractive plastics projects; tools, materials, instructions and plans includes approx. 1 lb. clear sheet plastic, 4-piece assorted plastic rods, coping saw, 2 sanding blocks and paper, 2 buffing pads, eye dropper, brush, scribe, ruler, jar each of dye, cement and wax, and blue print instructions for 8 plastics projects (utility tray, photo holder, bracelet, picture frame, letter opener, bill file, Christmas ornament, letter holder). Order **FUN KIT** today! \$2.95 ea. plus 10% postage and shipping, or sent C.O.D. Write for our new catalog.

HOUSE OF PLASTICS

Dept. Mo, 8648 Linwood

DETROIT 6,

MICHIGAN

THE GIFT FOR A MAN'S CHRISTMAS!
The KOTTERPULLER

Gets out the most stubborn cotterpins, quick and easy. For auto and aviation mechanics, garage men, shop men, farmers, hobbyists and anyone who works with tools.

DEALERS WANTED

Send Check or Money Order Today

The DORHONS Co.

3131 WEST 30th STREET • DEPT. 1
CLEVELAND 9, OHIO



ONLY **\$2.45**
POSTPAID
FULL MONEY BACK GUARANTEE

IF IT'S MADE BY LIONEL, YOU CAN GET IT AT MADISON HARDWARE



NEW LIONEL GG-1 PENN. Electric-Type LOCO
\$32.50

No. 2332

A masterpiece of scale detailing! Designed for third-rail operation; can easily be adjusted for pantograph current pick-up from overhead wires. The 2 pantographs can be raised or lowered. 20-wheel drive, realistic horn.

Madison has been World Headquarters for Lionel since 1909. We offer a complete line of Lionel Train Sets, Cars, and Accessories. Write for big Train folder—it's FREE

AUTOMATIC SEMAPHORE

No. 151...\$4.95

Another new touch for your Lionel system! Semaphore arm automatically operates when train passes.

PENNSYLVANIA STEAM-TYPE LOCO WITH SMOKE AND WHISTLE TENDER
No. 675LTS

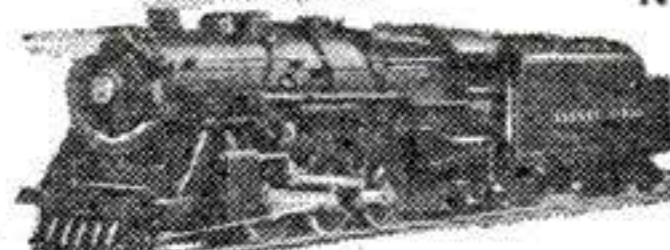

SEND US YOUR LIONEL REPAIRS

Here's realism. Rugged, powerful! Smoke synchronized with driving mechanism; puffs when in motion. 10 wheels.

"0" gauge **\$25.00** "027" gauge **\$24.50**

We pay postage on cash orders. C.O.D.'s accepted.

MADISON HARDWARE CO., 103 E. 23rd St., New York 10
Please ship
Quantity...GG-1 Penn. Loco @ \$32.50 ea.
...Automatic Semaphore @ \$4.95 ea.
PS ...675LTS Loco @ "0" gauge @ \$25.00 ea.
@ "027" gauge @ \$24.50 ea.
@ FREE Big Train Folder.

Name.....
Address.....
City.....Zone.....State.....
 Cash M. O. Check C. O. D.

MADISON HARDWARE CO., 103 EAST 23rd ST., N. Y. 10, N. Y.

BUILD IT YOURSELF

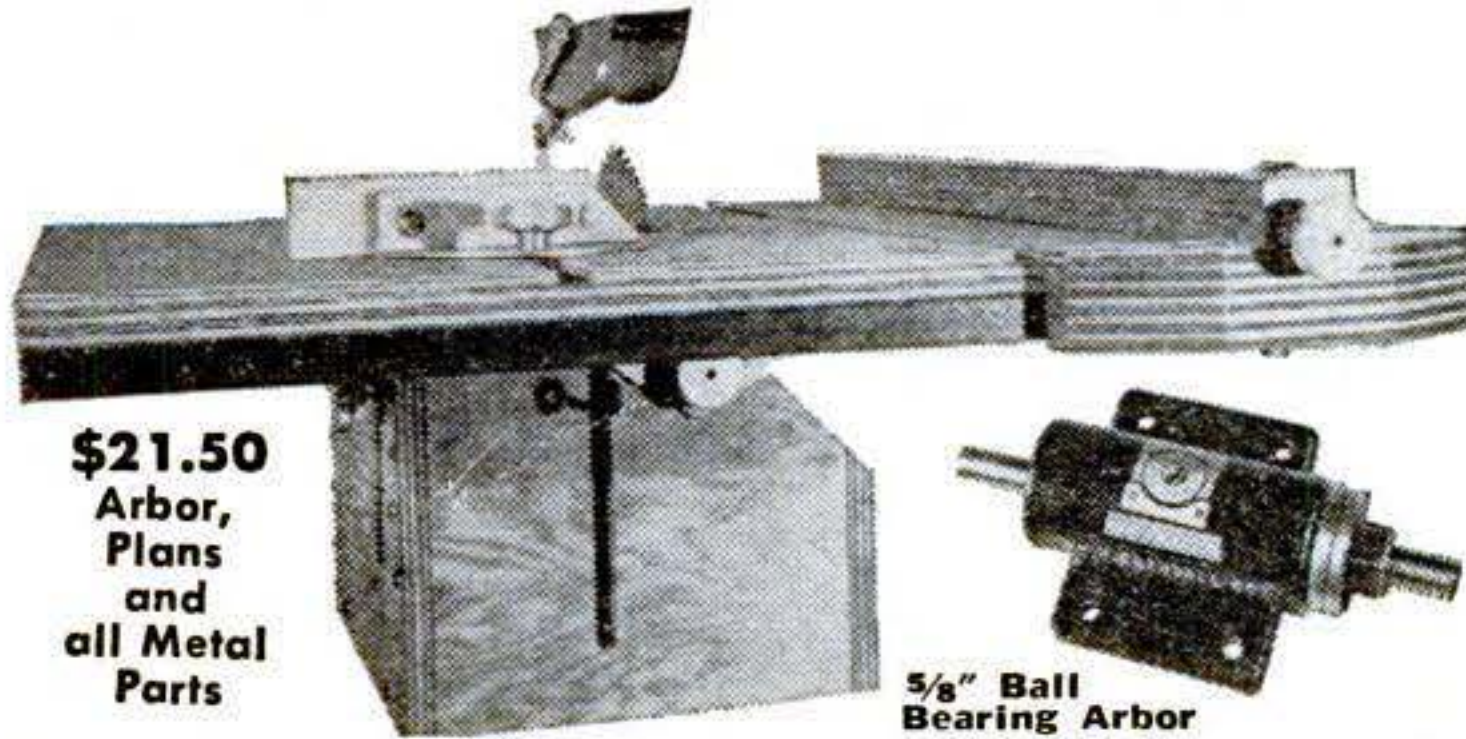

\$21.50
Arbor,
Plans
and
all Metal
Parts

**5/8" Ball
Bearing Arbor**

8" TILTING TABLE SAW

With our easy to follow step-by-step plans and instructions, you can build it with ordinary hand tools for a fraction the cost of all metal saws of comparable size and capacity. Sturdy wood, steel and aluminum construction.

FEATURES—Big roomy top 27" x 32" with 13 1/2" clearance ahead of saw. Tilts to 45°.

Precision built ball bearing arbor lubricated and sealed. No further lubrication required.

Self aligning, full strength rip fence. Indexed mitre gauge. Indexed table tilting quadrant. Adjustable saw arm—cuts from 0" to 2 1/4".

In California add 2 1/2% sales tax

- | | |
|--|----------------|
| COMPLETE KIT —Includes Ball Bearing Arbor with Saw Plans and instructions, and all metal parts, bolts, washers and screws (less saw blade)..... | \$21.50 |
| 5/8" Ball Bearing Arbor only —with Saw Plans and instructions | \$ 6.95 |
| Metal Parts only —less Arbor with Saw Plans and instructions..... | \$14.55 |
| Complete plans only | \$ 1.00 |

If your dealer cannot supply you, send check or money order—we will ship promptly postpaid in U.S.A. or possessions.

Dealer inquiries invited

WILLIAM H. CRANDALL COMPANY

1009 Fruitvale Avenue—Dept. P—Oakland 1, California



**World's Best
HAND TOOL**



Ideal gift for "him!" Never before was so much usefulness packed into a single hand tool. *Gives one hand **TON-GRIP**. *Locks to the work. *Remains locked with hands removed. And, now, complete with:

THIN NOSE Permits working in extremely close quarters.

NEW INVOLUTE JAW CURVE (1) Jaws can apply tremendous pressure on 4 points of any size nut. (2) Increases tooth-contact on round work, giving a mighty, non-slip grip. Holds round work up to 1 3/8" diameter. Better than a pipe wrench. (3) As a clamp, pressure can be applied exactly where wanted.

WIRE CUTTER Ton-pressure cuts wire and small bolts. Actually cuts 1/4" bolts by taking progressive bites.

KNURLED JAW TIPS Holds work at the very tip.

Easy to open. Made of fine alloy steel. Nickel plated. Two sizes—7" and 10"—with or without wire cutter.

GET YOURS NOW! See your dealer. With Cutter—7", \$2.25; 10", \$2.50. Without Cutter—7", \$1.85, 10", \$2.25.

PETERSEN MFG. CO., Dept. 38 DeWITT, NEBR.



New 22-piece CASCO Power Workshop puts 1001 Skills at your Fingertips

Here's what every hobbyist, home craftsman and mechanic has been waiting for! A high-speed Power Tool that's actually a complete, portable workshop! Each of its 20 precision made accessories can be instantly attached—transforming the tool into a dozen separate tools. Can be used on wood, metal, glass, plastic or other materials. Comes complete in a sturdy leatherette case. Handles like a pencil—is air-cooled.

The extra powerful, 20,000 RPM Tool plugs into any AC-DC socket. Has exclusive finger grip which permits closer work. Shockproof, unbreakable Tenite case; chrome fittings; on-off switch for one-hand operation; vibrationless high speed. Quiet, smooth-running, efficient.

- It Engraves!
- It Cleans!
- It Polishes!
- It Cuts!
- It Grinds!
- It Carves!
- It Saws!
- It Sands!
- It Buffs!
- It Etches!
- It Drills!
- It Brushes!



POWER TOOL COMPLETE WITH 20 ACCESSORIES, KIT AND PROJECT BOOKLET ONLY \$14.95 — IF BOUGHT SEPARATELY YOU'D PAY \$23.45

HERE'S WHAT YOU GET

- 1 Rubber Polishing Wheel • One 1/8" Speed Drill • One 1/8" Ball Cutter • Sturdy Leatherette Case • Valuable Project Booklet • 3 Bristle Brushes • 2 Abrasive Separating Discs • 3 Mandrels • 1 Felt Wheel • 2 Collets • 1 Dressing Stick • 1 Wrench • 4 Emery Wheels • **PLUS AC-DC Electric POWER TOOL.** At leading stores everywhere!

CASCO

Another good buy—Casco-Electri-Craft Kit—has 36 accessories and steel storage chest—\$32.95 if purchased separately—an outstanding value at only \$22.50.

YOU DO BETTER WORK WITH A BETTER TOOL
CASCO PRODUCTS CORPORATION • BRIDGEPORT 2, CONN.

TO:

Reader

FROM:

Editor

One Man's

Meat

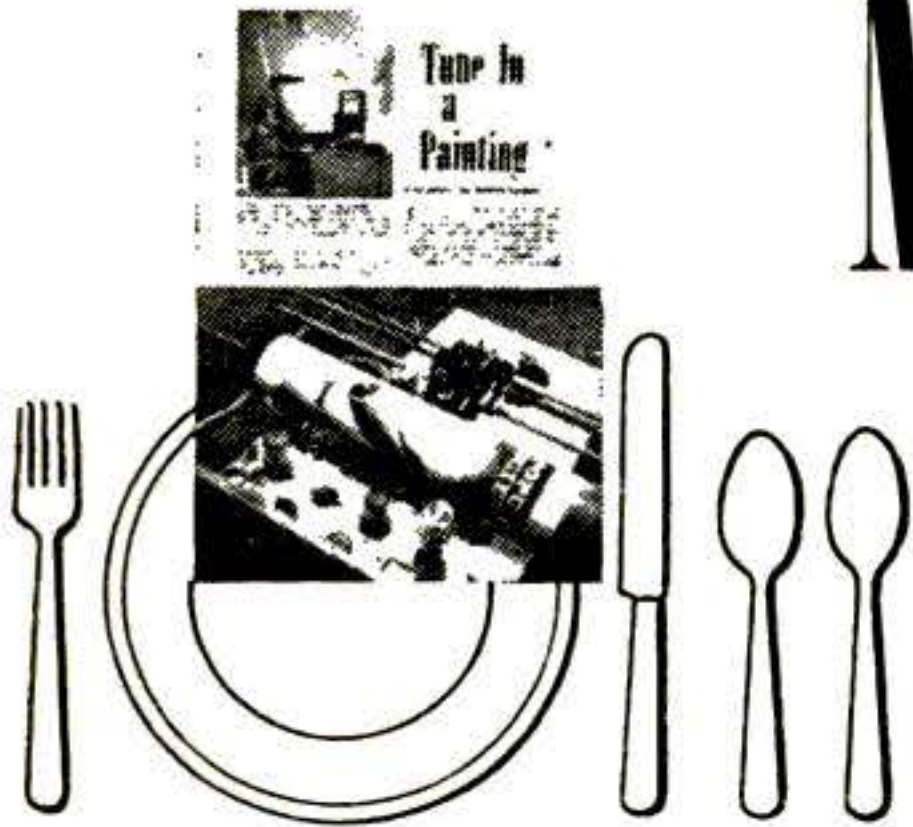

A DECENT interval after this issue reaches subscribers, about a thousand interested readers will sit down to fill out a question form they have received. On this long, detailed questionnaire they will check their readership of every major article and department in the magazine. And they will tell us what they liked best, how old they are, what kind of job they hold. They will do all this on their own time, under no compulsion, simply because they want to.

A few—a very few—will indulge themselves with anonymous wisecracks. But far more will volunteer helpful comments.

Some Are Sour

Not all of these remarks will be favorable. Some will be sincere and sour. These hurt, but we like to get honest opinions. Then there are the readers who say, "Give us more photography articles—or more wood-working." One wants bigger workshop projects; another pleads for simpler jobs that don't call for power tools.

Last month I got two beauties—oh, yes indeed I get them; every questionnaire with comments is automatically sent direct to my desk. These two readers unwittingly represented the north and south poles of the same little world that is PSM. One wrote: "would like to see more articles on the important developments in science; too many shop articles." The other answered: "serious stuff okay, but why not more dope on new cars

and tools? Want more metalworking." The occupations were the tip-off—one was a college student, the other a refrigerator welder.

An editor is really just a cook in a print shop. It's his job to serve what people will want when they see it on the menu. Aside from being a professional magazine cook, perhaps my best recommendation for this job at PSM is that I used to eat here myself—and still do. As a regular reader, sitting out front, I enjoyed the magazine for years. Back here in the kitchen, ordering the supplies, watching the ideas as they are boiled into articles and pictures, tasting constantly every dish on the menu of the month, I sometimes wonder if anything will be good when the crowd sits down.

Proof of the Pudding

Then the printers dish up the first proofs, and I sit down myself to eat the issue. Sometimes I start at the front and read straight through. Or start at the back and flip from one high spot to another.

But usually I go through the magazine looking at pictures, reading headlines and captions. Knowing the words (because I read most of them when they were still only typewriting on yellow paper), I am always a little amazed at how much you can get out of PSM without even reading it.

Tattletale Mail

Anyway, when the votes from readers come in I'm anxious to find out how *they* liked the things *I* liked on the menu. Usually the articles we think are interesting enough to get the most space are what you like best. But every issue there are a couple of surprises—articles that turn out to be more popular than we expected. And where there are winners there are always losers—some of our little favorites make crash landings in the reader polls.

Maybe you've never received a ballot. Or maybe you buy your PSM at a newsstand, as I used to before I got free copies. If so, you never get a ballot.

In any case, *if you'd like to chip in your two cents worth*, send me a penny post card. Just address it: GITHENS, PSM, 353 FOURTH AVE., NEW YORK 10, N. Y. Write your name and address, and the letter "B." I'll see that you get a ballot. And you can be sure we'll all be glad to get your opinion on the articles in this issue.



S O U T H B E N D

Precision Lathes

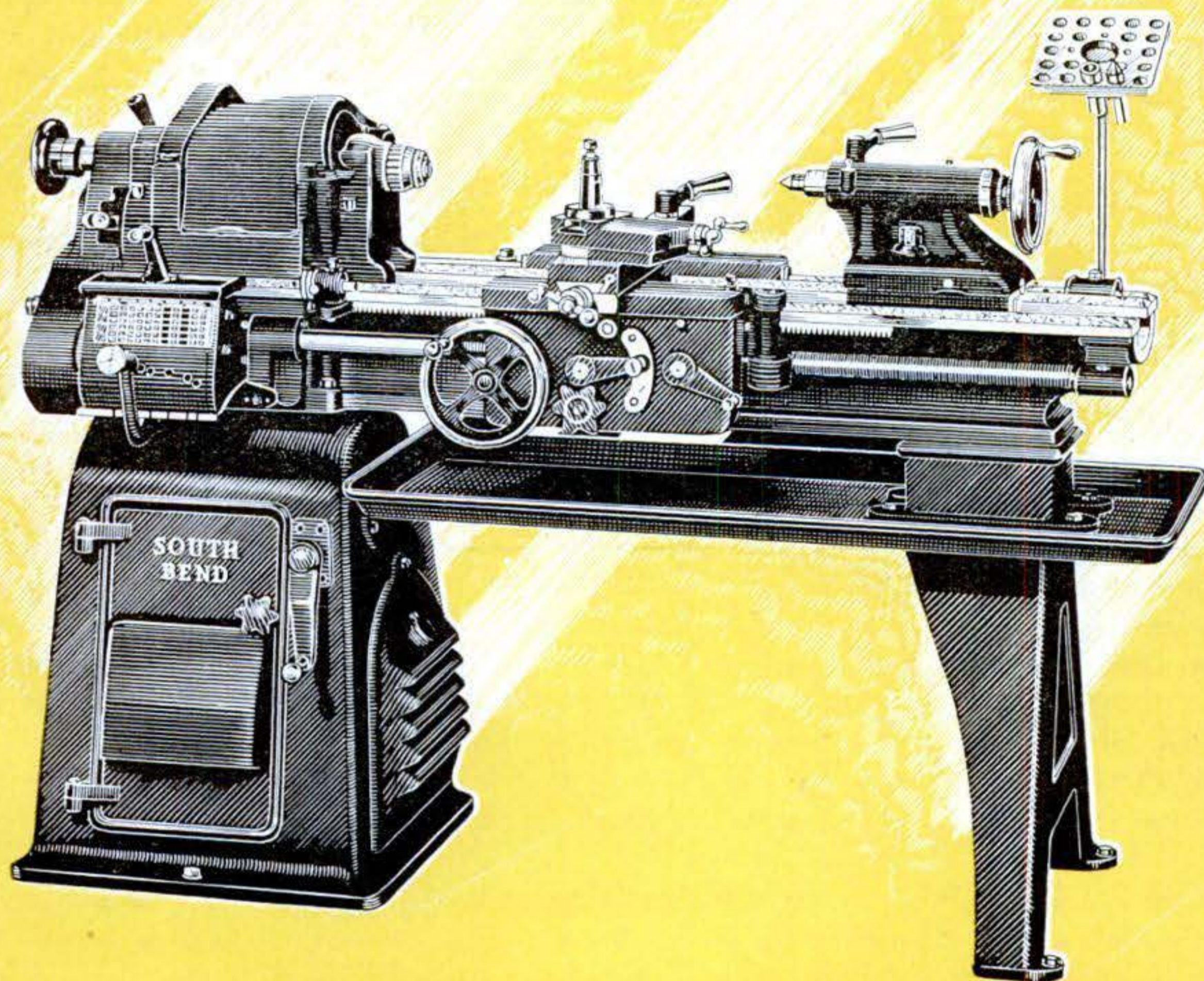

The South Bend Precision Lathes and Lathe Attachments shown on the following pages are the result of forty years of experience in building fine lathes. The workmanship and materials entering into their construction are the best that can be obtained and the highest standards of accuracy are maintained throughout their manufacture.

S O U T H B E N D L A T H E W O R K S



BUILDING BETTER LATHES SINCE 1906 • 524 E. MADISON STREET • SOUTH BEND 22, INDIANA, U.S.A.
CABLE ADDRESS "TWINS" SOUTH BEND

ESTABLISHED 1906
INCORPORATED 1914

PROMPT DELIVERY

Quick deliveries can now be made from distributor's stock in all principal cities, or from factory. For name of distributor see "Machine Tools" in classified section of phone book. If there is no distributor near you, send your orders and inquiries direct to the factory.

PRICES

Prices of South Bend Lathes are reasonable, the average increase over pre-war level being less than 15%. All prices are net f.o.b. factory, crated for domestic shipment.

SOUTH BEND

16", 14½", and 13" Quick Change Gear Lathes

South Bend 16" x 6' Quick Change Gear Lathe
\$1640.50

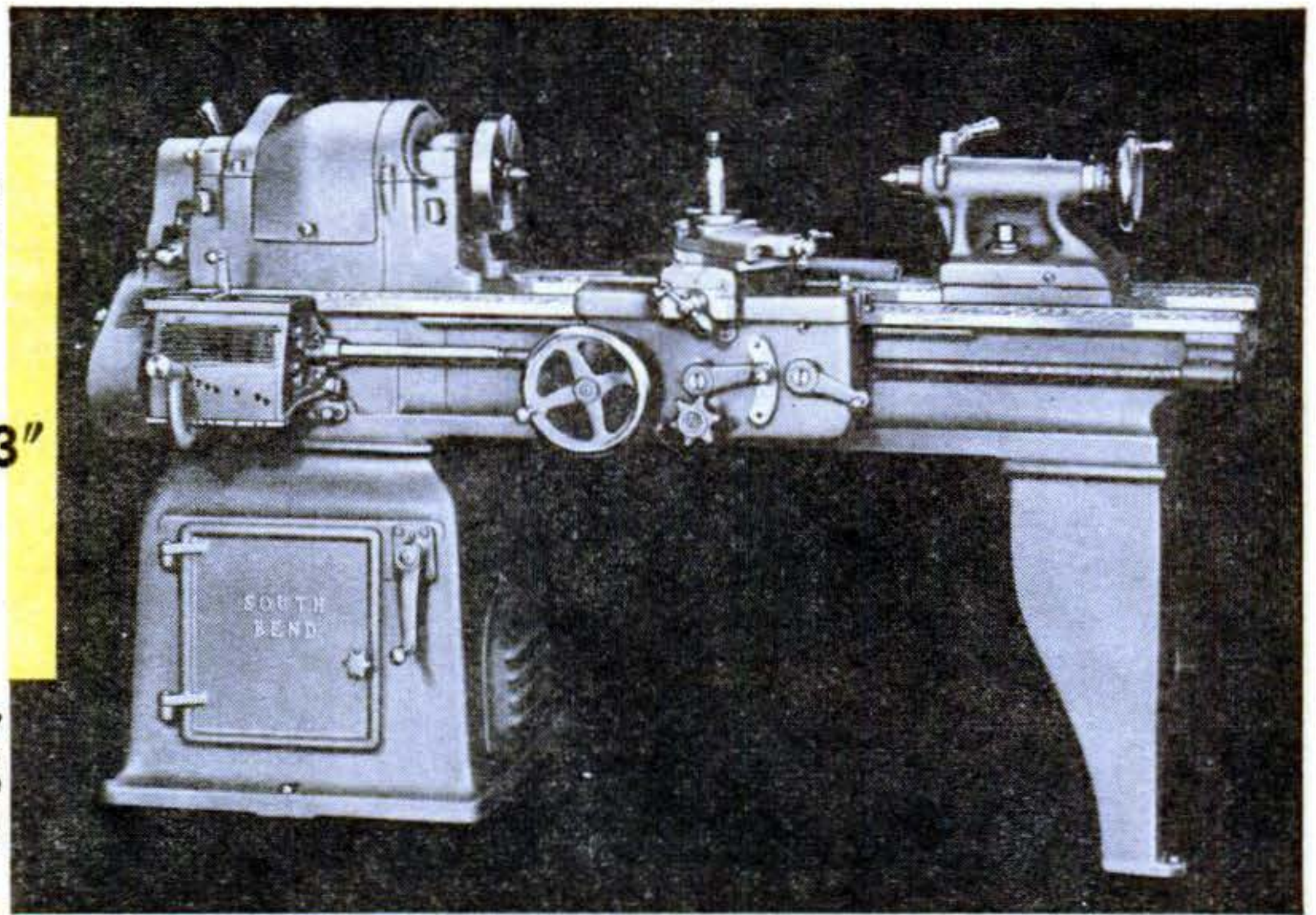

SPECIFICATIONS	16-INCH	14½-INCH	13-INCH
Swing over bed and saddle wings.....	16¼"	14⅝"	13⅞"
Swing over saddle, chip guard removed	11⅞"	10¼"	8¾"
Swing over saddle with chip guard.....	9⅝"	8¾"	7¾"
Spindle speeds.....	21 to 725 r.p.m.	27 to 800 r.p.m.	34 to 875 r.p.m.
Thread cutting range.....	4 to 224 R.H. or L.H.	4 to 224 R.H. or L.H.	4 to 224 R.H. or L.H.
Power longitudinal feeds.....	.0015" to .0841"	.0015" to .0841"	.0015" to .0841"
Power cross-feeds.....	.0006" to .0312"	.0006" to .0312"	.0006" to .0312"
Hole thru spindle.....	1⅜"	1⅞"	1"
Collet capacity.....	1"	¾"	11/16"
Spindle centers.....	No. 3 Morse Taper	No. 3 Morse Taper	No. 3 Morse Taper
Size motor.....	1½ h.p.	1½ h.p.	1 h.p.

South Bend Quick Change Gear Lathes are equally efficient on precision toolroom work or close tolerance manufacturing operations. Hundreds of nationally known manufacturers select them when streamlining their shop equipment to meet present day needs. Substantial savings in capital investment, power consumption, floor space, and labor costs have resulted from their installation. They will give you the same efficient service.

The Underneath Motor Drive provides an unusually wide range of spindle speeds. The belt drive to the spindle is silent in operation and develops smooth, steady power entirely free from gear vibration.

Price includes 3 ph., 60 cy., 220 v. A.C. motor and drum control, and regular lathe equipment such as belts, centers, face plates, tool post, etc. Chucks and tools are extra. See following pages.

Quick Change Gear Underneath Motor Driven Lathes

Catalog Number	Swing Over Bed Inches	Length of Bed Feet	Distance Between Centers Inches	Approx. Shipping Weight Pounds	Price f.o.b. Factory
16" QUICK CHANGE GEAR LATHES					
117-C	16¼"	6	33½"	2300	\$1640.50
117-D	16¼"	7	45½"	2380	1678.50
117-E	16¼"	8	57½"	2460	1716.50
117-G	16¼"	10	81½"	2620	1826.50
117-H	16¼"	12	105½"	2850	1936.50
14½" QUICK CHANGE GEAR LATHES					
183-B	14⅝"	5	24½"	1995	\$1382.50
183-C	14⅝"	6	36½"	2070	1420.50
183-D	14⅝"	7	48½"	2145	1458.50
183-E	14⅝"	8	60½"	2225	1496.50
13" QUICK CHANGE GEAR LATHES					
113-A	13⅞"	4	16	1460	\$1117.50
113-B	13⅞"	5	28	1510	1153.50
113-C	13⅞"	6	40	1560	1189.50
113-D	13⅞"	7	52	1615	1225.50

TIME PAYMENT PLAN

25 per cent down
 12 months to pay balance
 moderate finance charges

SOUTH BEND LATHE WORKS, 524 E. Madison Street, South Bend 22, Indiana, U.S.A.

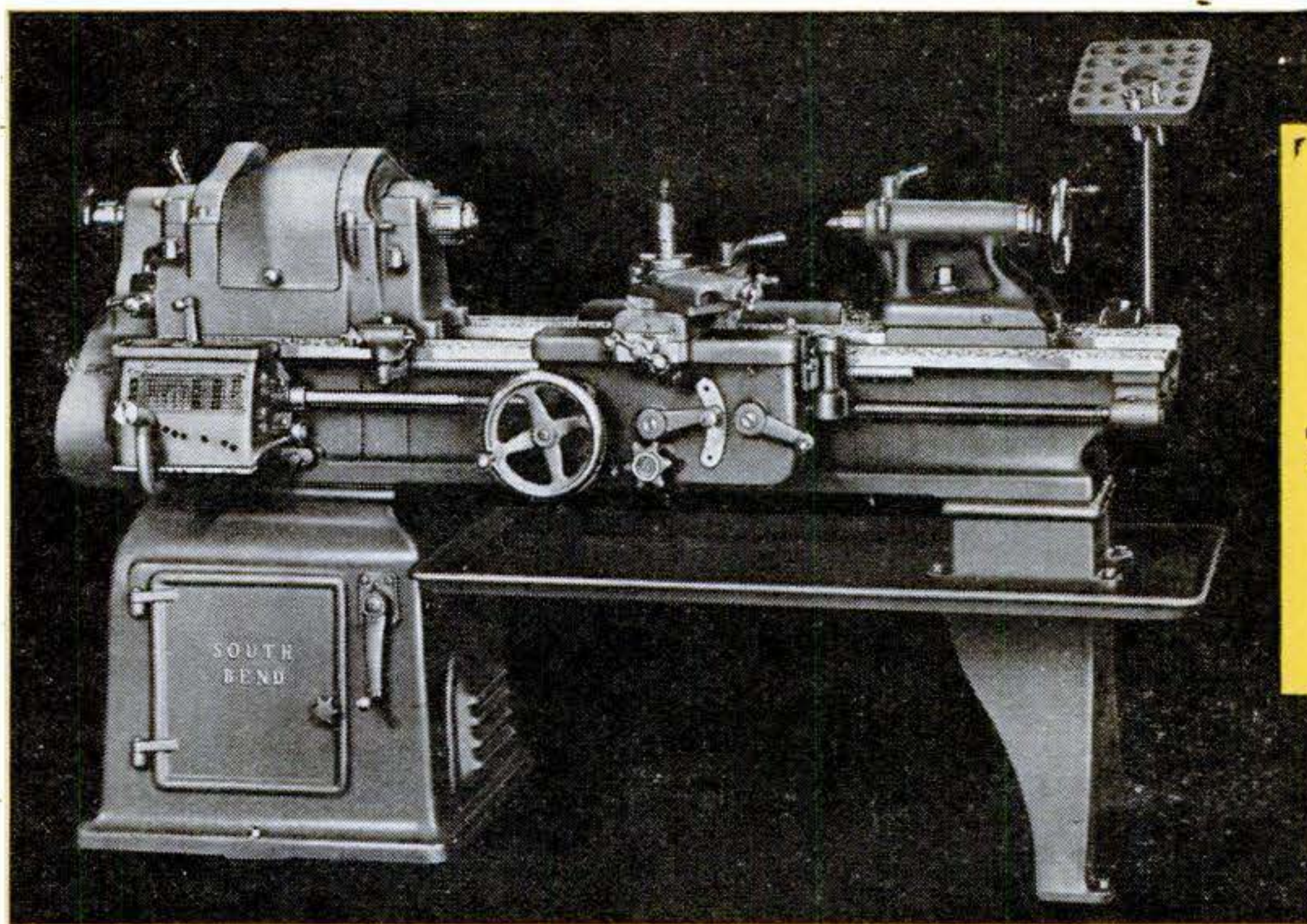

SOUTH BEND

16", 14½", and 13" Toolroom Lathes

South Bend 16" x 6'
Toolroom Lathe
\$2031.50

SPECIFICATIONS

	16-INCH	14½-INCH	13-INCH
Swing over bed and saddle wings...	16¼"	14⅝"	13⅞"
Swing over saddle cross slide.....	9⅝"	8-15/16"	8"
Spindle speeds.....	21 to 725 r.p.m.	27 to 800 r.p.m.	34 to 875 r.p.m.
Thread cutting range.....	4 to 224 R.H. or L.H.	4 to 224 R.H. or L.H.	4 to 224 R.H. or L.H.
Power longitudinal feeds.....	.0015" to .0841"	.0015" to .0841"	.0015" to .0841"
Power cross-feeds.....	.0006" to .0312"	.0006" to .0312"	.0006" to .0312"
Hole thru spindle.....	1⅜"	1⅝"	1"
Collet capacity.....	1"	¾"	11/16"
Spindle centers.....	No. 3 Morse Taper	No. 3 Morse Taper	No. 3 Morse Taper
Size motor.....	1½ h.p.	1½ h.p.	1 h.p.

Toolroom Underneath Motor Driven Lathes

Catalog Number	Swing Over Bed Inches	Length of Bed Feet	Distance Between Centers Inches	Approx. Shipping Weight Pounds	Price f.o.b. Factory
16-INCH TOOLROOM UNDERNEATH BELT MOTOR DRIVEN LATHES					
8117-C	16¼"	6	33½"	2525	\$2031.50
8117-D	16¼"	7	45½"	2605	2075.50
8117-E	16¼"	8	57½"	2685	2119.50
14½-INCH TOOLROOM UNDERNEATH BELT MOTOR DRIVEN LATHES					
8183-B	14⅝"	5	24½"	2180	\$1735.50
8183-C	14⅝"	6	36½"	2255	1778.50
8183-D	14⅝"	7	48½"	2330	1821.50
8183-E	14⅝"	8	60½"	2405	1863.50
13-INCH TOOLROOM UNDERNEATH BELT MOTOR DRIVEN LATHES					
8113-B	13⅞"	5	28	1665	\$1481.50
8113-C	13⅞"	6	40	1715	1519.50
8113-D	13⅞"	7	52	1770	1557.50

South Bend Toolroom Lathes are equally efficient on precision toolroom work or close tolerance manufacturing operations. Their versatility reduces set-up time to a minimum. Smooth, vibration-free operation permits finish turning or boring with such precision that subsequent machine operations can often be eliminated. A convenient arrangement of controls makes for an ease of operation which reduces fatigue and lowers the probability of error. A wide range of spindle speeds permits machining work with maximum tool efficiency.

Improved Features include: alloy steel headstock spindle; replaceable headstock bearings; double wall apron; quick change gear box for threads and feeds; and semi-steel lathe bed.

In Addition to 3-ph., 60 cy., 220 v., A.C. motor and drum control, and all equipment supplied with quick change gear lathe (see preceding page) the following toolroom attachments are included in price of lathe: handwheel type draw-in collet chuck attachment; collet rack; telescopic taper attachment; thread dial indicator; chip pan; and micrometer carriage stop. Chucks, tools, and collets are extra.

SOUTH BEND LATHE WORKS, 524 E. Madison Street, South Bend 22, Indiana, U.S.A.

SOUTH BEND

10"-1" Collet Lathes

SPECIFICATIONS

- Swing over bed and saddle wings.....10 $\frac{1}{8}$ "
- Swing over saddle cross slide.....5 $\frac{3}{4}$ "
- Spindle speeds (12).....50 to 1357 r.p.m.
- Thread cutting range....4 to 224 R.H. or L.H.
- Power longitudinal feeds.... .0015" to .0836"
- Power cross-feeds..... .0006" to .0309"
- Hole thru spindle.....1 $\frac{3}{8}$ "
- Collet capacity.....1"
- Spindle centers.....No. 2 Morse Taper
- Cross slide travel.....5 $\frac{7}{8}$ "
- Compound rest top slide travel.....2"
- Size motor..... $\frac{3}{4}$ h.p.



10-inch Swing South Bend Precision Lathes are capable of the most exacting operations on both tool and production work. This accuracy, together with their speed and versatility, contribute to lower machining costs. They contain all the design features that make the larger models so dependable.

Price includes 3 ph., 60 cy., 220 v., A.C. motor; drum control, and regular lathe equipment such as belts, centers, face plates, tool post, etc. Chucks and tools are extra. Toolroom Lathes also include: handwheel type draw-in collet attachment (without collets); collet rack; telescopic taper attachment; thread dial indicator; and micrometer carriage stop. Bench is included in price of bench lathe.

TIME PAYMENT TERMS

25 per cent down
12 months to pay balance
moderate finance charges

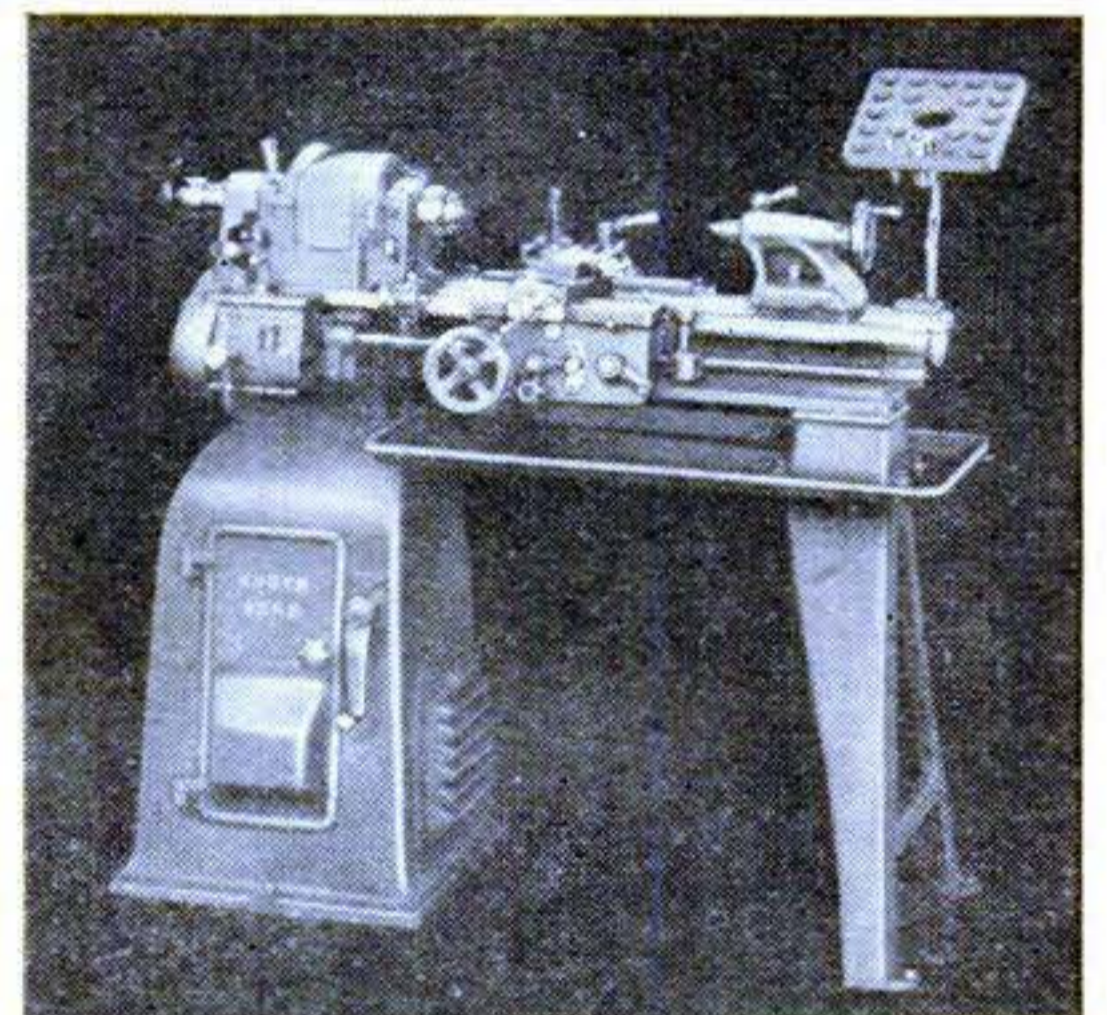

South Bend 10" x 3 $\frac{1}{2}$ ', 1" Collet Toolroom Lathe **\$1168.60**

10"-1" Collet Quick Change Gear and Toolroom Lathes

Catalog Number	Swing Over Bed Inches	Length of Bed Feet	Between Centers Inches	Shipping Weight Pounds	Price f.o.b. Factory
QUICK CHANGE GEAR BENCH LATHES					
187-YS	10 $\frac{1}{8}$	3	15 $\frac{3}{4}$	850	\$933.60
187-ZS	10 $\frac{1}{8}$	3 $\frac{1}{2}$	20 $\frac{3}{4}$	880	949.60
187-AS	10 $\frac{1}{8}$	4	26 $\frac{3}{4}$	950	975.60
187-RS	10 $\frac{1}{8}$	4 $\frac{1}{2}$	33 $\frac{3}{4}$	980	998.60
QUICK CHANGE GEAR LATHES WITH FLOOR LEGS					
187-Y	10 $\frac{1}{8}$	3	15 $\frac{3}{4}$	810	\$863.60
187-Z	10 $\frac{1}{8}$	3 $\frac{1}{2}$	20 $\frac{3}{4}$	835	879.60
187-A	10 $\frac{1}{8}$	4	26 $\frac{3}{4}$	860	895.60
187-R	10 $\frac{1}{8}$	4 $\frac{1}{2}$	33 $\frac{3}{4}$	885	918.60

Catalog Number	Swing Over Bed Inches	Length of Bed Feet	Between Centers Inches	Shipping Weight Pounds	Price f.o.b. Factory
TOOLROOM BENCH LATHES					
8187-YS	10 $\frac{1}{8}$	3	15 $\frac{3}{4}$	960	\$1196.60
8187-ZS	10 $\frac{1}{8}$	3 $\frac{1}{2}$	20 $\frac{3}{4}$	990	1212.60
8187-AS	10 $\frac{1}{8}$	4	26 $\frac{3}{4}$	1060	1238.60
TOOLROOM LATHES WITH FLOOR LEGS					
8187-Y	10 $\frac{1}{8}$	3	15 $\frac{3}{4}$	935	\$1151.60
8187-Z	10 $\frac{1}{8}$	3 $\frac{1}{2}$	20 $\frac{3}{4}$	960	1168.60
8187-A	10 $\frac{1}{8}$	4	26 $\frac{3}{4}$	985	1185.60

SOUTH BEND LATHE WORKS, 524 E. Madison Street, South Bend 22, Indiana, U.S.A.

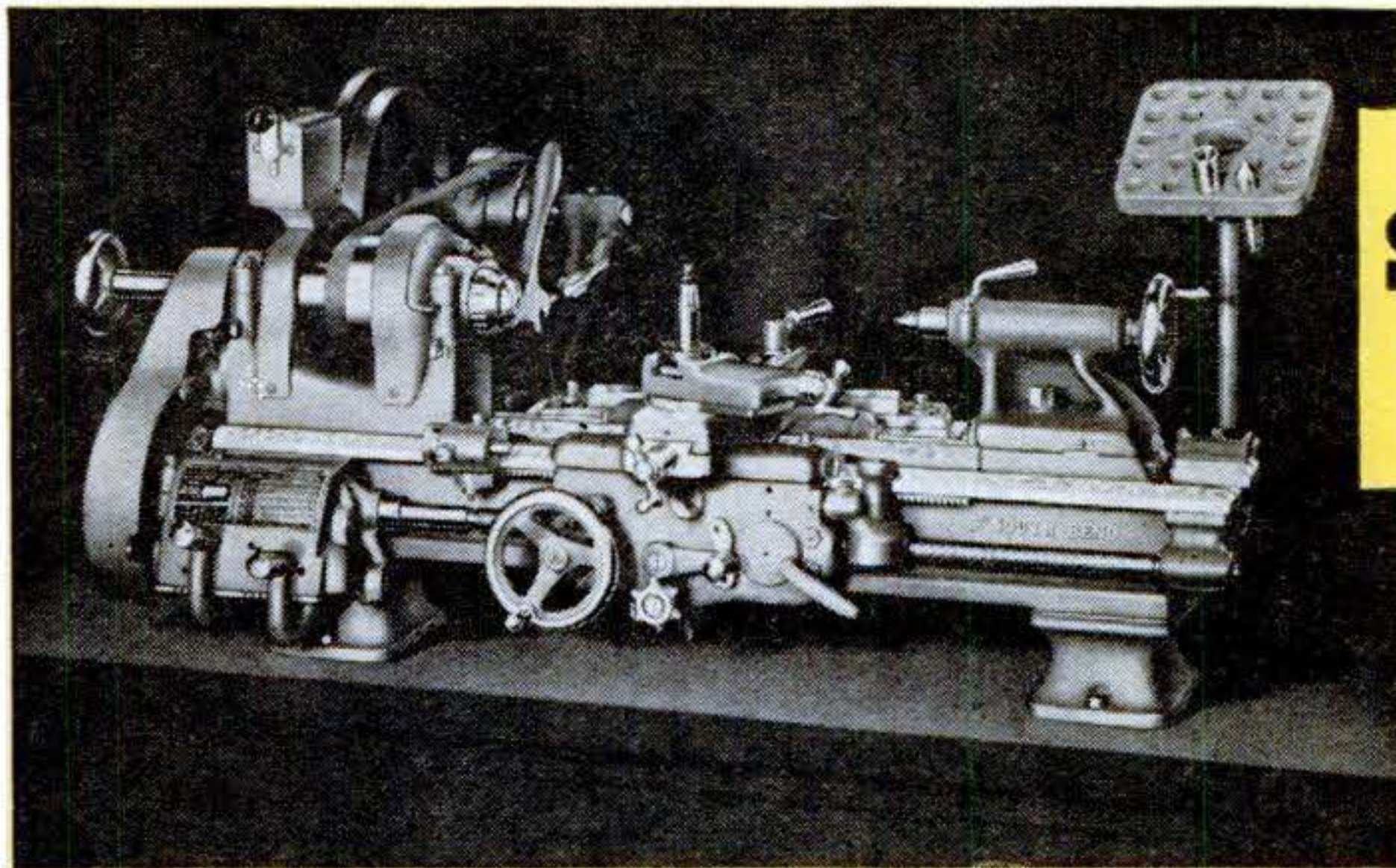

South Bend 9" x 3' Toolroom Bench Lathe

\$486.70

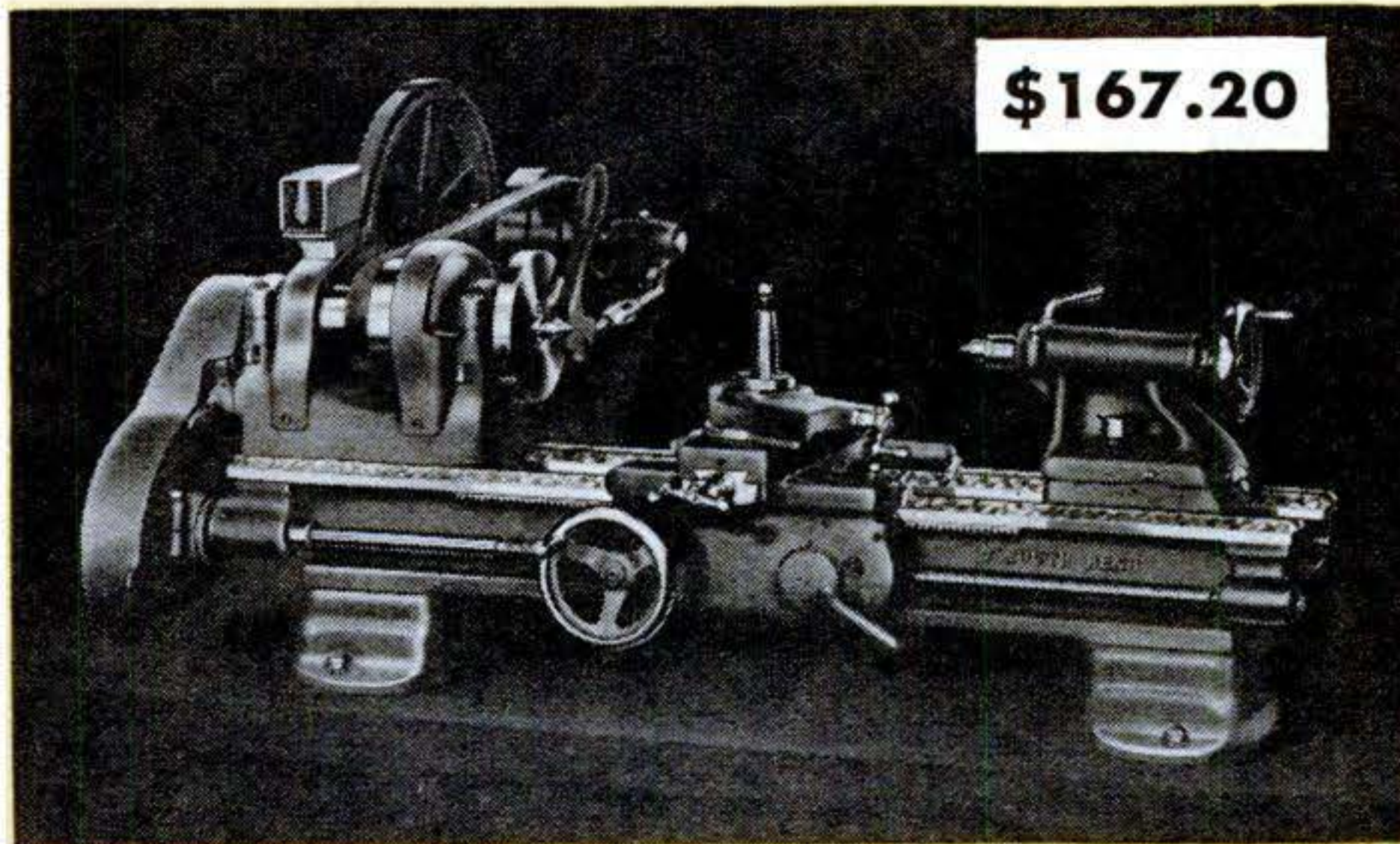

South Bend 9" x 3' Model C Bench Lathe

\$167.20

SOUTH BEND

9-Inch Bench Lathes

SPECIFICATIONS

- Swing over saddle wings.....9 1/4"
- Swing over chip guard.....5 1/2"
- Spindle speeds:
- 6 speed drive.....41 to 658 r.p.m.
- 12 speed drive.....41 to 1270 r.p.m.
- Thread cutting range:
- Model A.....48 pitches R.H. or L.H.
4 to 224 per inch
- Models B & C...45 pitches R.H. or L.H.
4 to 160 per inch
- Power longitudinal feeds:
- Model A.....48—.0015" to .0853"
- Model B.....26—.0021" to .0155"
- Model C.....14—.0021" to .0156"
- Power cross feeds:
- Model A.....48—.0004" to .0252"
- Model B.....23—.001" to .0046"
- Belt, width of pulley step for.....1"
- Centers, Morse taper.....No. 2
- Collet capacity, maximum.....1/2"
- Headstock spindle hole.....3/4"
- Lead screw 29° Acme Thread.....3/4"—8
- Motor, size required:
- For 6-speed drive.....1/4 h.p.
- For 12-speed drive.....1/2 h.p.
- Spindle nose threads.....1 1/2"—8
- Tailstock top set over.....3/8"
- Tool holder cutter bit.....1/4" sq.
- Tool holder shank.....3/8" x 13/16"
- Approx. shipping weights:
- 3 ft. bed lathe.....355 lbs.
- 3 1/2 ft. bed lathe.....380 lbs.
- 4 ft. bed lathe.....405 lbs.
- 4 1/2 ft. bed lathe.....430 lbs.

Model A 9-inch Lathes have heat-treated alloy steel spindle, quick change gear box, and friction clutch worm drive for power longitudinal feeds and power cross-feeds.

Model B 9-inch Lathes are same as Model A Lathes except that they have independent change gears, instead of the quick change gear box, for threads and feeds.

Model C 9-inch Lathes are same as Model B Lathes except they do not have the worm drive for power feeds. The cross-feed is hand-operated, and

longitudinal feeds are obtained by engaging half-nuts with the lead screw.

Toolroom 9-inch Lathes are same as Model A Lathes except that they have the following toolroom attachments: collet chuck; collet rack; taper attachment; thread dial; and micrometer carriage stop.

Price includes 1 ph., 60 cy., 115 v., A.C. motor, drum control, and regular lathe equipment such as belts, centers, small face plate, tool post, etc. Chucks, collets, and tools are extra.

9-Inch Swing Horizontal Motor Driven South Bend Precision Bench Lathes

Length Bed Feet	Be- tween Cent- ers Inches	9" TOOLROOM LATHES		9" MODEL A LATHES		9" MODEL B LATHES		9" MODEL C LATHES							
		Cat. No.	Price	Cat. No.	Price	Cat. No.	Price	Cat. No.	Price	Cat. No.	Price				
3	16	8644-Y	\$486.70	444-Y	\$272.20	644-Y	\$317.70	477-Y	\$217.20	677-Y	\$262.70	415-YC	\$167.20	615-YC	\$212.70
3 1/2	22	8644-Z	501.70	444-Z	287.20	644-Z	332.70	477-Z	232.20	677-Z	277.70	415-ZC	182.20	615-ZC	227.70
4	28	8644-A	516.70	444-A	302.20	644-A	347.70	477-A	247.20	677-A	292.70	415-AC	197.20	615-AC	242.70
4 1/2	34	444-R	324.20	644-R	369.70	477-R	269.20	677-R	314.70	415-RC	219.20	615-RC	264.70

SOUTH BEND LATHE WORKS, 524 E. Madison Street, South Bend 22, Indiana, U.S.A.

9" SOUTH BEND V-Belt Horizontal Motor Driven Bench Lathes

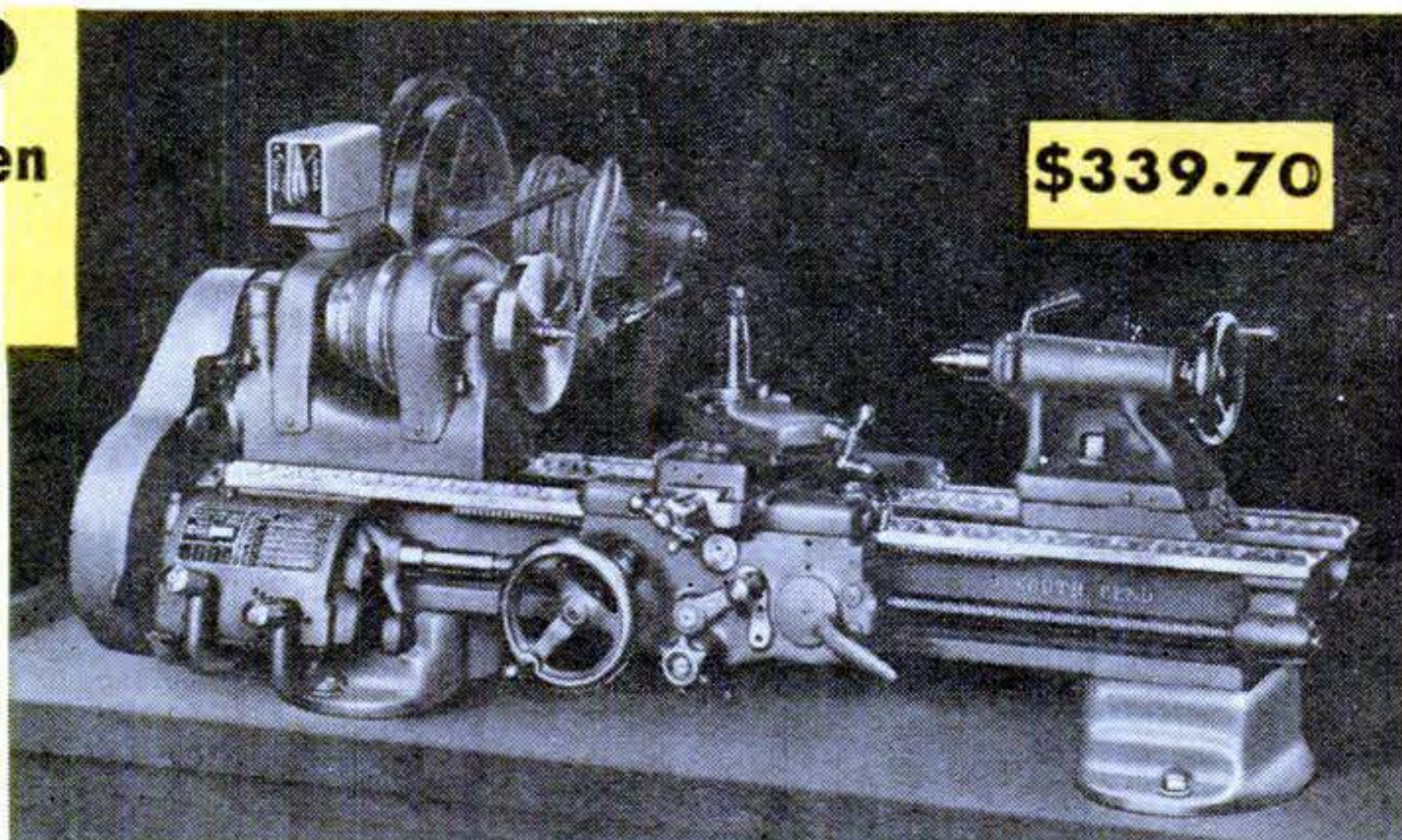

The 9" Bench Lathes with 8-speed and 16-speed V-belt horizontal motor drives offer more spindle speeds—an advantage when surface speeds are critical. These lathes are identical in all other respects to those described on the preceding page.

Price includes 1 ph., 60 cy., 115 v., A.C. motor, drum control, and regular lathe equipment such as belt, centers, small face plate, tool post, etc. Chucks, collets, tools, and bench are extra.

TIME PAYMENT TERMS

25 per cent down
12 months to pay
balance
Moderate finance
charges

SPECIFICATIONS

Swing over saddle wings.....9¼"
Swing over chip guard.....5½"
Hole thru spindle.....¾"
Collet capacity.....½"
Spindle speeds
8 speed drive....46 to 609 r.p.m.
16 speed drive....46 to 1176 r.p.m.
Thread cutting range:
Model A.....48 pitches R.H. or L.H.
4 to 224 per inch.
Models B & C .45 pitches R.H. or L.H.
4 to 160 per inch.

Power longitudinal feeds
Model A.....48—.0015" to .0853"
Model B.....26—.0021" to .0155"
Model C.....14—.0021" to .0156"
Power cross-feeds
Model A.....48—.0004" to .0252"
Model B.....23—.001" to .0046"
Spindle centers.....No. 2 Morse Taper
Size motors
8 speed drive.....¼ h.p.
16 speed drive.....½ h.p.

9-Inch Bench Lathes with V-Belt Horizontal Motor Drive

Length Bed Feet	Between Centers Inches	Ship. Wt. Crated Pounds	MODEL A		MODEL B		MODEL C	
			8-speed drive	16-speed drive	8-speed drive	16-speed drive	8-speed drive	16-speed drive
			Cat. No.	Price	Cat. No.	Price	Cat. No.	Price
3	16	355	544-Y \$294.20	744-Y \$339.70	577-Y \$239.20	777-Y \$284.70	515-YC \$189.20	715-YC \$234.70
3½	22	380	544-Z 309.20	744-Z 354.70	577-Z 254.20	777-Z 299.70	515-ZC 204.20	715-ZC 249.70
4	28	405	544-A 324.20	744-A 369.70	577-A 269.20	777-A 314.70	515-AC 219.20	715-AC 264.70
4½	34	430	544-R 346.20	744-R 391.70	577-R 291.20	777-R 336.70	515-RC 241.20	715-RC 286.70

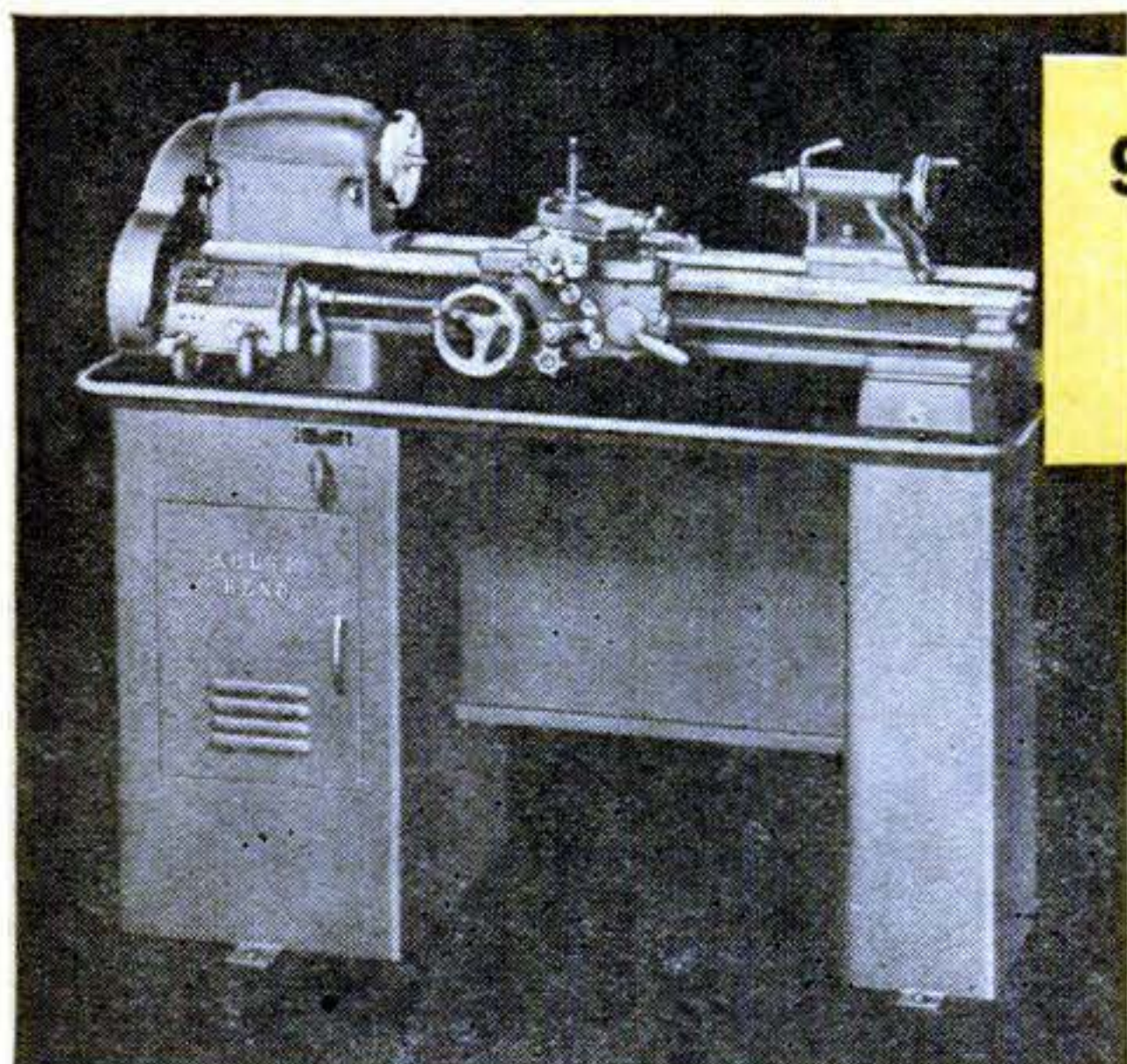

9" SOUTH BEND Underneath Motor Driven Lathe

Capable of machining work to the most exacting tolerances, this lathe is recommended for precision work in the toolroom, laboratory, or machine shop. Fully enclosed motor drive unit provides twelve spindle speeds, 41 to 1270 r.p.m. See above for other specifications. Price includes 1 ph., 60 cy., 115 v., A.C. motor, drum control, and regular lathe equipment. Chucks, collets, and tools are extra.

9" Underneath Motor Driven Lathes

Catalog Number	Model	Length of Bed Feet	Between Centers Inches	Weight Crated Pounds	Price f.o.b. Factory
344-ZN	A	3½	22	570	\$486.70
377-ZN	B	3½	22	560	431.70
8344-ZN	Toolroom	3½	22	630	655.70

SOUTH BEND LATHE WORKS, 524 E. Madison Street, South Bend 22, Indiana, U.S.A.

SOUTH BEND

Precision Turret Lathes

SPECIFICATIONS	SERIES 900	SERIES 1000	SERIES 2-H
Collet capacity.....	1/2"	1"	1"
Hole thru spindle.....	3/4"	1 3/8"	1 3/8"
Swing over bed and saddle wings.....	9 1/4"	10 1/8"	16 1/4"
Swing over double tool-slide.....	3-9/16"	3-9/16"	6 7/8"
Swing over compound slide.....	5 1/2"	5 7/8"	6 1/8"
Turret tool feed.....	4"	4"	6 1/8"
Turret face to spindle distance, max.....	20 3/8"	19 3/8"	6' bed—28 1/4"
Double tool slide cross travel.....	3 3/8"	3 3/8"	9 3/4"
Thread cutting range, 48..	4—224 per in.	4—224 per in.	4—224 per in.
Spindle speeds, 12.....	41-1270 r.p.m.	50—1357 r.p.m.	16-880 r.p.m.
Carriage power feeds:			
Longitudinal, 48.....	.0015"—.0853"	.0015"—.0836"	.0015"—.0841"
Transverse, 48.....	.0004"—.0252"	.0006"—.0309"	.0006"—.0312"
Carriage longitudinal travel.....	18"	16"	6' bed—22 1/2"
Turret power feeds.....0001"—.0148"
Turret indexing tolerance at 4" from turret face.....	.0005"	.0005"	.0005"
Size motor.....	1/2 h.p.	3/4 h.p.	1 1/2 h.p.

Series 900. This turret lathe is specifically designed for second operations on small, precision parts. Its accuracy, and speed of handling and machining produce appreciable economies in manufacturing that are not possible with heavy turret lathes. Price includes 1 ph., 60 cy., 115 v.,

A.C. motor, drum control, power feed universal carriage, handlever bed turret, handlever cross slide, compound rest cross slide, coolant return assembly, and metal column base with built-in oil pan.

Series 1000. Designed for the same types of applications as the Series 900, these turret lathes with their larger capacities are ideal for machining a wide variety of precision parts. Numerous choices of spindle speeds, power longitudinal and transverse carriage feeds, and thread cutting feeds keep production efficient. Price includes 3 ph., 60 cy., 220 v., A.C. motor, drum control, power feed universal carriage, handlever bed turret, handlever cross slide, compound rest cross slide, oil pan, and coolant return assembly.

Series 2-H. The production of precision duplicate parts in both machine shops and toolrooms is simplified with 2-H Turret Lathes. They are especially suited for exacting second operations on large work because of their accuracy and ease of operation. Price includes 3 ph., 60 cy., 220 v., A.C. motor, drum control, power feed universal carriage with screw feed double tool slide having front and rear tool blocks, power feed ram-type turret, and oil pan.

Prices of turret lathes do not include coolant pump or collet equipment.

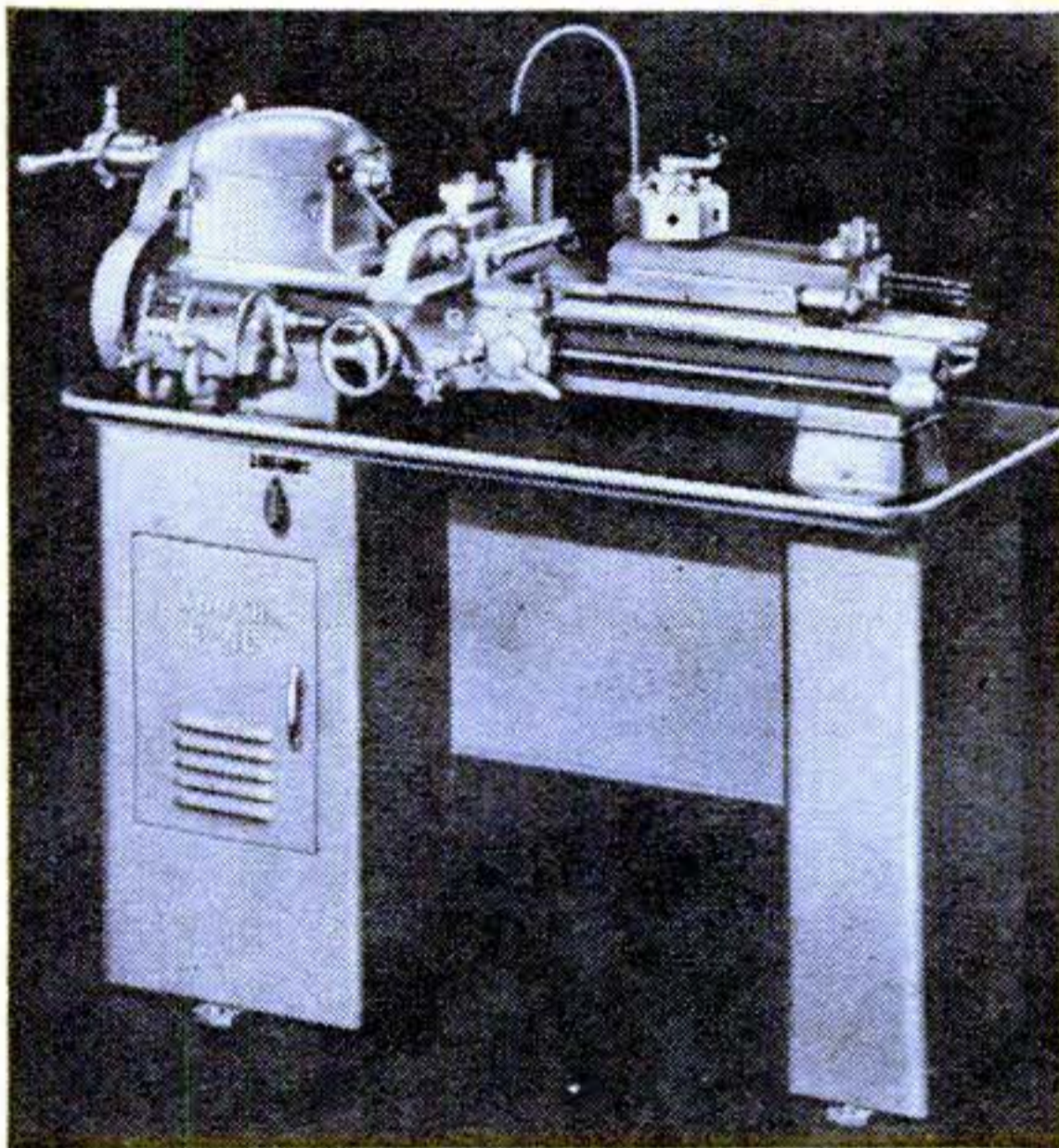

Ser. 900, Cat. No. 930-Z Turret Lathe \$765.70

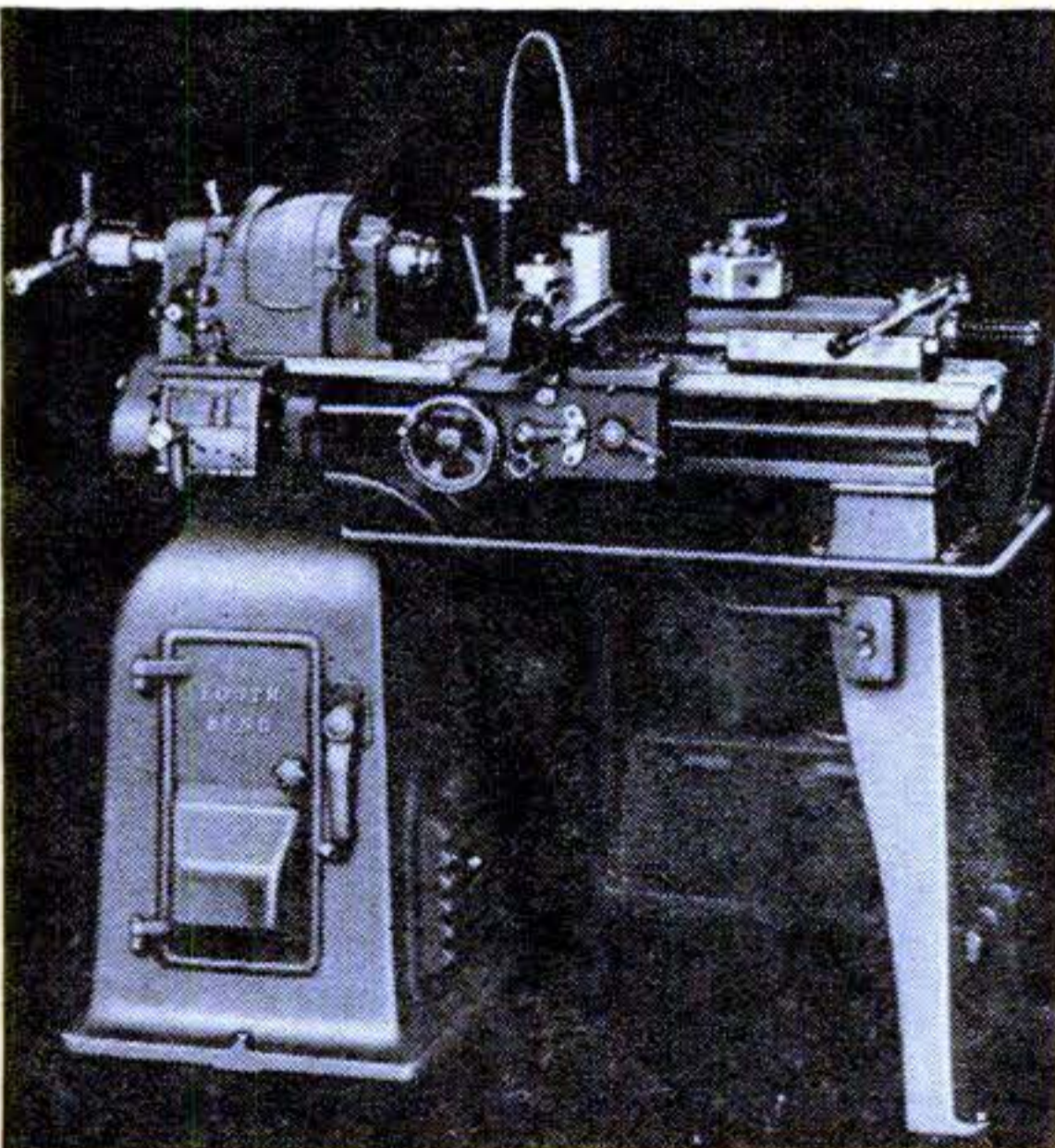

Ser. 1000, Cat. No. 1006-Z Turret Lathe \$1199.60

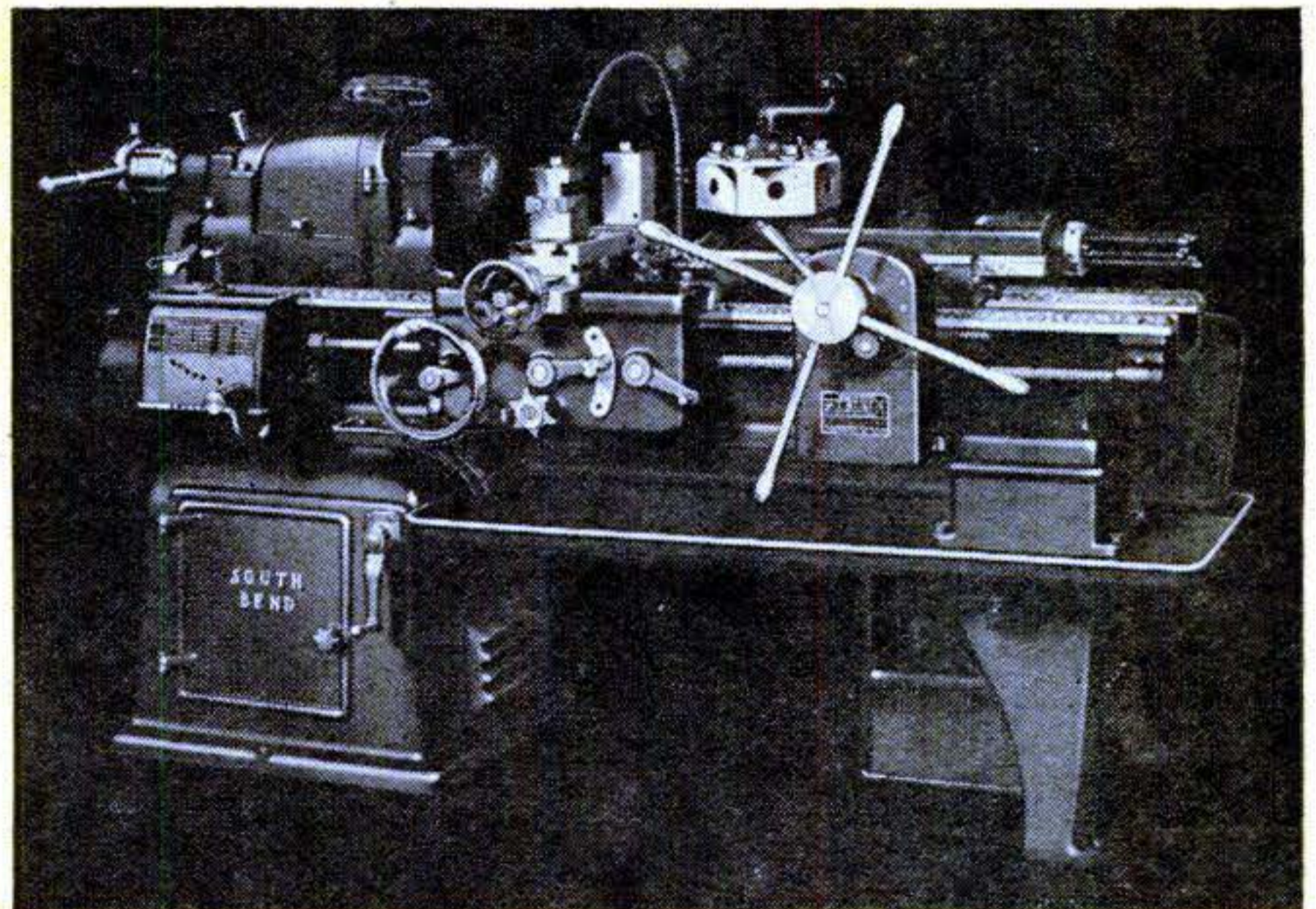

Series 2-H, Cat. No. 2-CT Turret Lathe (6' bed) \$2500.00

SOUTH BEND LATHE WORKS, 524 E. Madison Street, South Bend 22, Indiana, U. S. A.

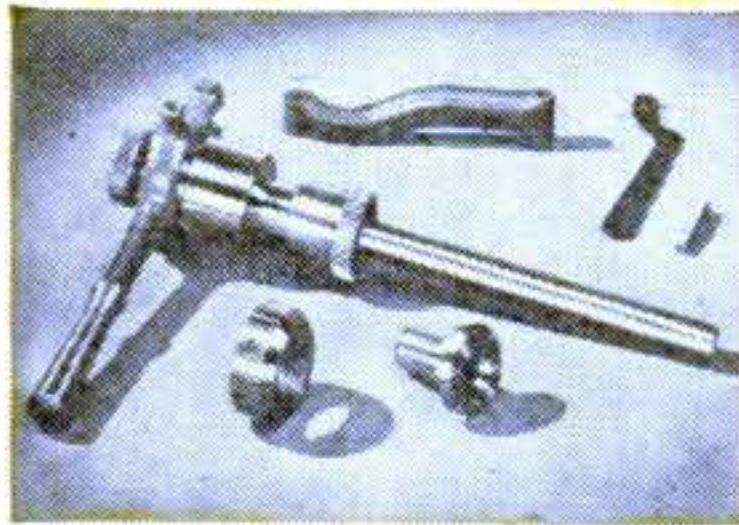

HANDLEVER COLLET ATTACHMENT

The Handlever Collet Attachment is an aid to rapid production work. Stock can be released and fed through the collet without stopping the lathe.

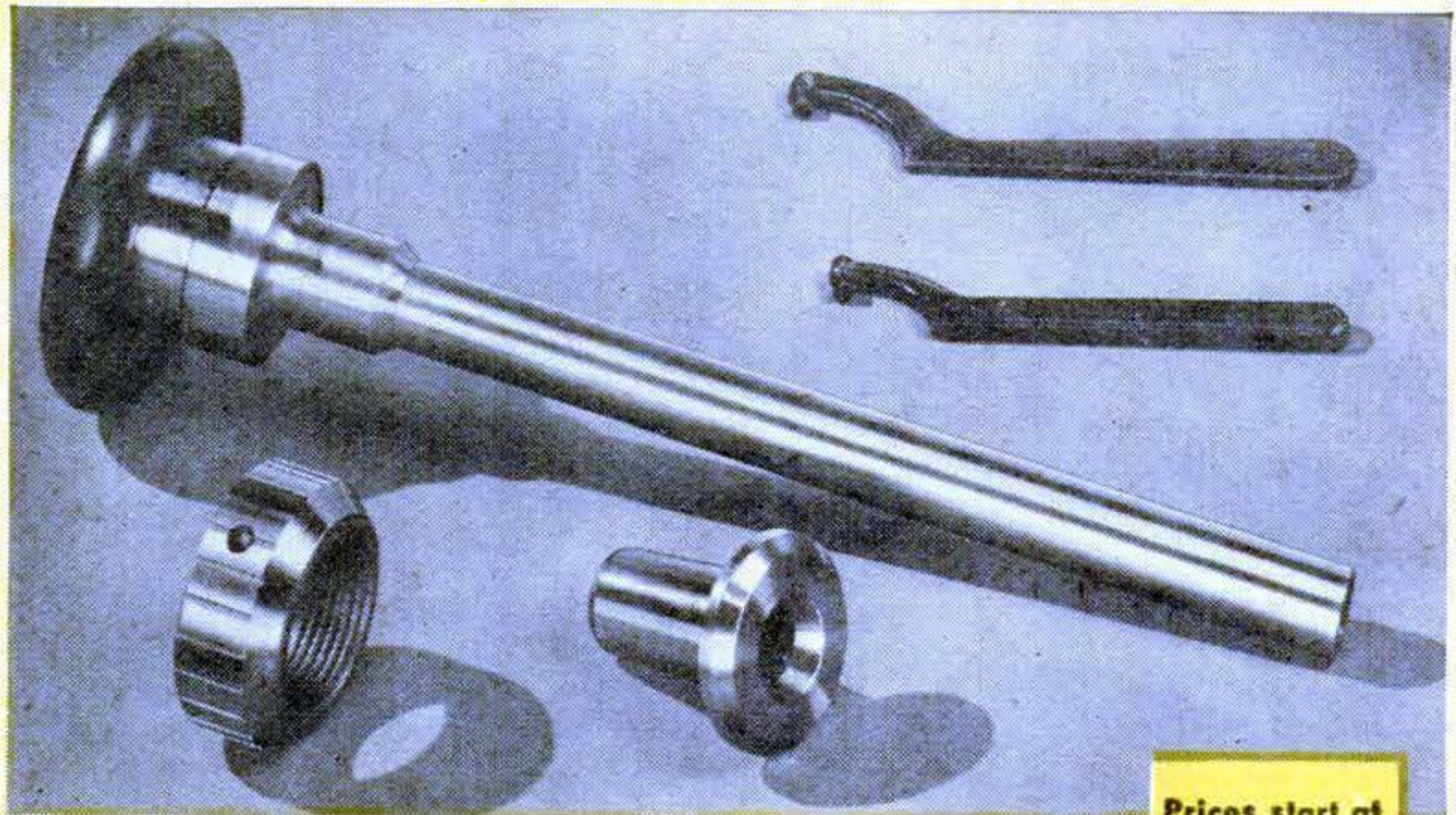

Handwheel Draw-in Collet Attachment

Prices start at

\$25

**Collet Attachment
HANDWHEEL TYPE**

The Handwheel Collet Attachment is a very accurate type of chuck. It is used for precision toolroom work and for the manufacture of small parts, or wherever extremely close tolerances are required. Bar and tube stock can be fed through the hollow draw-bar that operates the collet. Equipment includes draw-bar, spindle nose cap, spanner wrench, and closing sleeve. Collets are not included.

DRAW-IN COLLET ATTACHMENTS

Size of Lathe	Collet Required	Max. Collet Cap.	Handwheel Type		Handlever Type	
			Catalog Number	Price	Catalog Number	Price
9" and Series 900.....	No. 3	1/2"	4306-W	\$25	5206-W	\$ 85
10"—11/16" Collet.....	No. 2	11/16"	4310	40	5210	120
10"—1" Col. & Series 1000.	No. 5	1"	4312	50	5219	150
13".....	No. 2	11/16"	4313	40	5213	120
14 1/2".....	No. 4	3/4"	4314	45	5214	140
16", 16/24", & No. 2-H....	No. 5	1"	4316	50	5216	150

Collet Rack and Collet Chest

Collet Rack No. 1770-W holds 19 collets, all others hold 17 collets. Collets are not included.

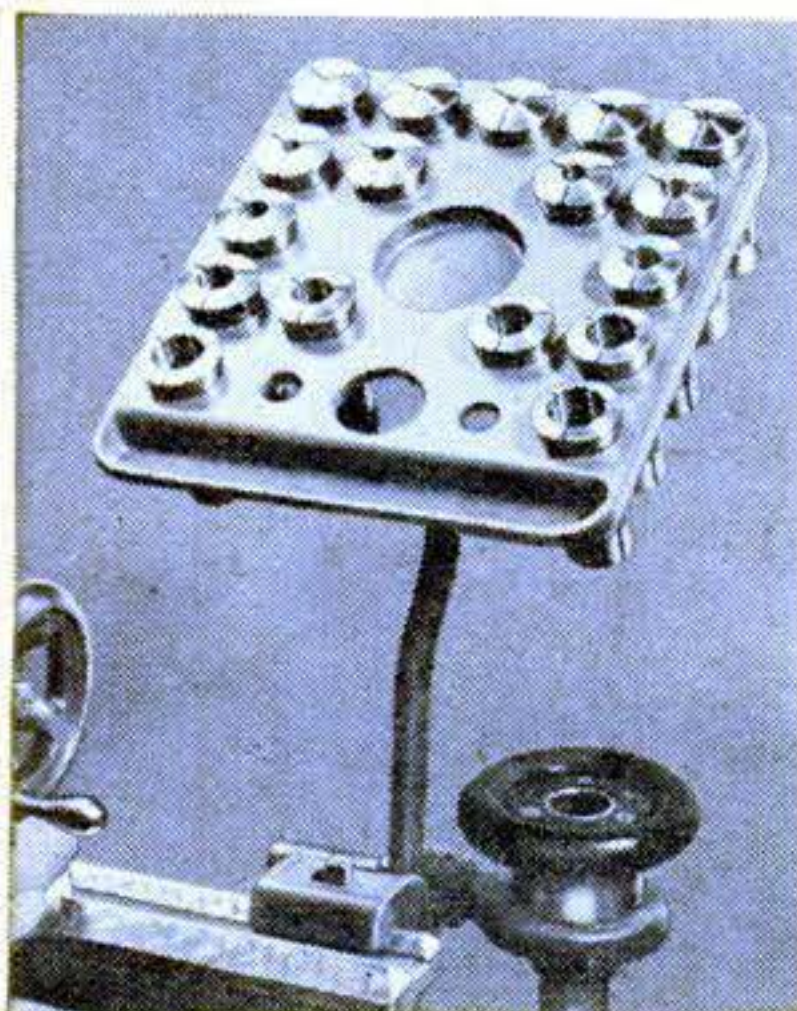

COLLET RACK

Holds collets, centers, spindle sleeve, draw-bar, spindle nose cap, wrench, etc.

COLLET RACKS

Catalog Number	Size of Lathe	Price
1770-W	9" and 900	\$12
1752	10"—11/16" Col.	15
1753	10"—1" Col.	17
1753	Ser. 1000	17
1772	13"	15
1791	14 1/2"	17
1774	16" & 16/24"	17

No. 2225—Collet Chest only, for holding handwheel collet attachment and collets for 9" lathe. Collet attachment and collets not included. Price: \$7.50

No. 2220—Collet Chest, 9" handwheel collet attachment and 29 steel collets for round work, 1/16" to 1/2" by 64ths. Complete: \$122.00

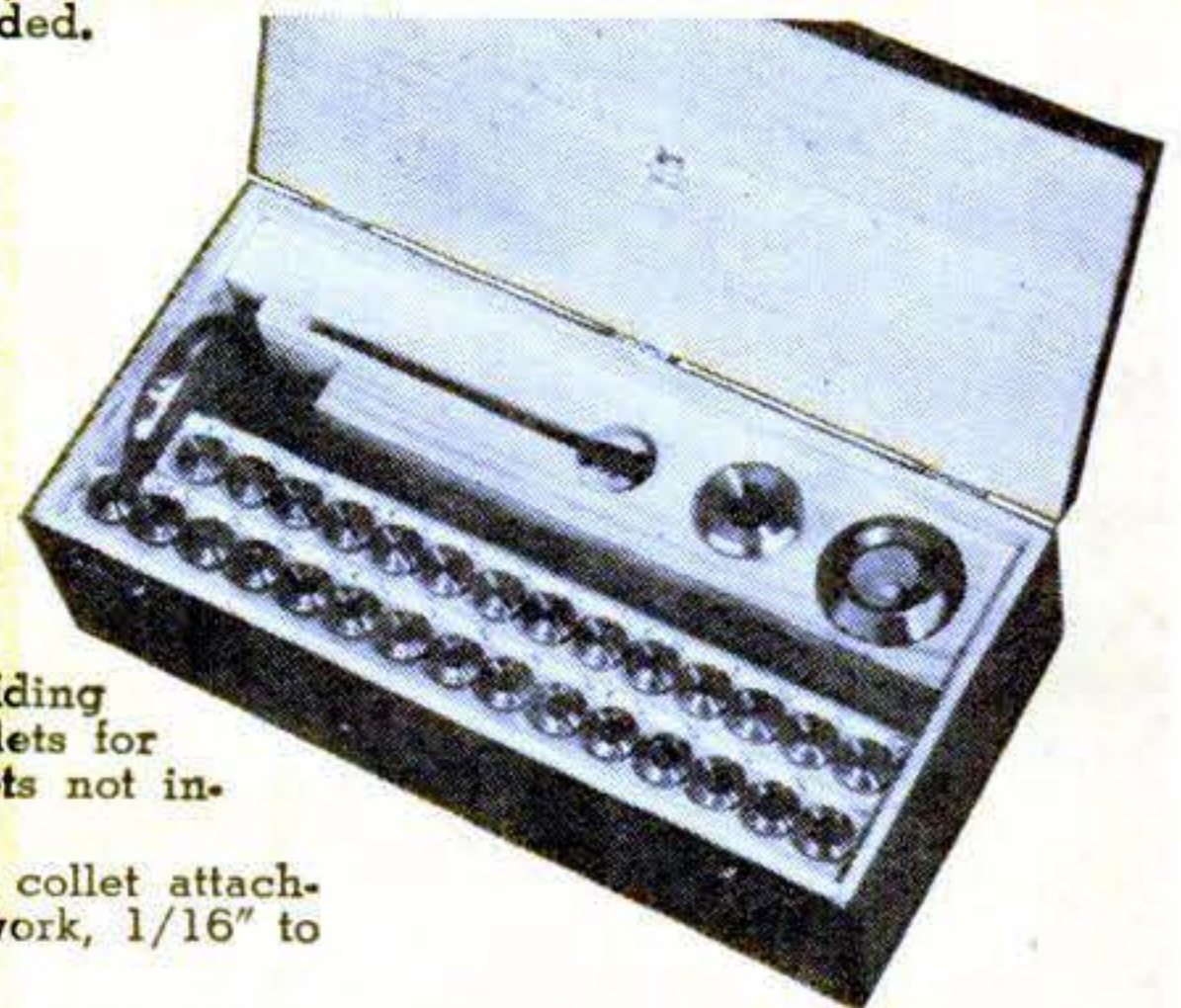

COLLET CHEST

Holds handwheel collet attachment and 29 collets. Well constructed of wood.

TIME PAYMENT TERMS

When order includes lathe 25 per cent down 12 months to pay balance moderate finance charges

Collets and Collet Sets

South Bend Collets, manufactured with the same exacting care as South Bend Lathes, deliver long, dependable service on precision work. Each collet is carefully inspected and tested, and packed in substantial plastic box with transparent lid through which the size can be read for easy selection.

Steel Collets are carefully heat-treated for maximum service and are precision ground to exceedingly close tolerances.

Brass Collets, a South Bend innovation, have many practical applications.

Their low cost makes them desirable for odd sizes that are used only occasionally. They can be readily machined on the job for holding tapered or irregular shapes. When worn, they can be rebores to larger diameters.

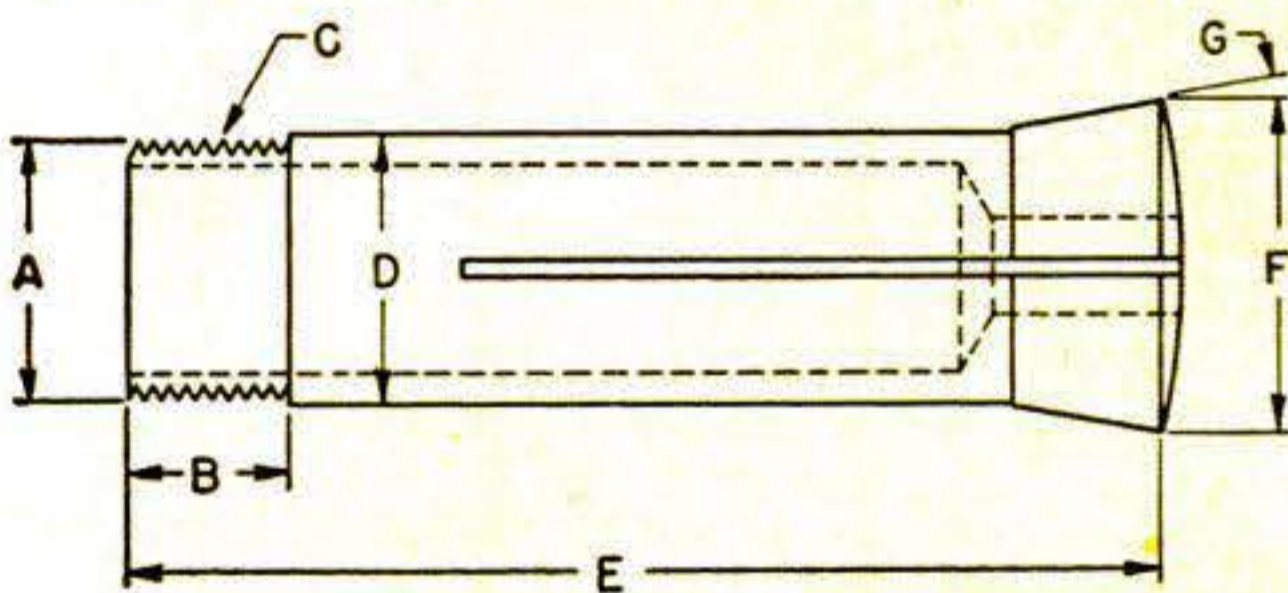

Specifications of Steel and Brass Collets

Collet Number	* For South Bend Lathes	A Thread Diameter Inches	B Thread Length Inches	C Threads Per Inch	D Body Diameter Inches	E Collet Length Inches	F Head Diameter Inches	G Angle Length Degrees
3	9" and Series 900	.650	3/4	26	.6495	2-11/16	.852	12
2	10"—11/16" Col. and 13"	.855	13/16	20	.8595	3-5/16	1.095	15
5	10"—1" Collet, 1000, 2-H, 16", and 16/24"	1.250	3/4	20	1.2495	3-9/32	1.452	10
4	14 1/2"	.950	13/16	20	.9495	3	1.150	10

*Collets can also be used on any other lathe or machine which they will fit.

South Bend Collets and Collet Sets

Collet	Description	Steel Collets		Brass Collets	
		Cat. No.	Price	Cat. No.	Price
No. 3	1 Collet, any standard size 1/16" to 1/2" in 64ths.....	609-W	\$ 3.75	1696	\$ 2.00
	Set of 8 Collets in 16ths, 1/16" to 1/2".....	2047	27.00	2235	15.00
	Set of 7 Collets in odd 32nds, 3/32" to 15/32".....	2476	24.00	2534	13.00
	Set of 14 Collets in odd 64ths, 5/64" to 31/64".....	2477	46.00	2535	24.00
	Decimal Collets (.0625" to .500") each.....	769-W	4.00	1856	2.15
	Metric Collets (1.5 mm to 12.5 mm) each.....	773-W	4.00	1702	2.15
No. 2	1 Collet, any standard size 1/16" to 11/16" in 64ths.....	1721	4.00	1697	2.25
	Set of 11 Collets in 16ths, 1/16" to 11/16".....	2432	39.00	2238	23.00
	Set of 10 Collets in odd 32nds, 3/32" to 21/32".....	2478	36.00	2536	21.00
	Set of 20 Collets in odd 64ths, 5/64" to 43/64".....	2479	71.00	2537	40.00
	Decimal Collets (.0625" to .6875") each.....	769-N	4.25	1857	2.40
	Metric Collets (1.5 mm to 17.0 mm) each.....	773-N	4.25	1703	2.40
No. 5	1 Collet, any standard size 1/16" to 1" in 64ths.....	1722	4.75	1698	2.50
	Set of 16 Collets in 16ths, 1/16" to 1".....	2435	68.00	2241	37.00
	Set of 15 Collets in odd 32nds, 3/32" to 31/32".....	2482	64.00	2540	35.00
	Set of 30 Collets in odd 64ths, 5/64" to 63/64".....	2483	127.00	2541	65.00
	Decimal Collets (.0625" to 1.000") each.....	769-R	5.00	1858	2.65
	Metric Collets (1.5 mm to 25.0 mm) each.....	773-R	5.00	1704	2.65
No. 4	1 Collet, any standard size 1/16" to 3/4" in 64ths.....	1713	4.25	1699	2.35
	Set of 12 Collets in 16ths, 1/16" to 3/4".....	2438	46.00	2244	26.00
	Set of 11 Collets in odd 32nds, 3/32" to 23/32".....	2480	42.00	2538	24.00
	Set of 22 Collets in odd 64ths, 5/64" to 47/64".....	2481	81.00	2539	45.00
	Decimal Collets (.0625 to .7500") each.....	769-K	4.50	1859	2.50
	Metric Collets (1.5 mm to 19.0 mm) each.....	773-K	4.50	1705	2.50



Steel Collet



Brass Collet



Collet Packaged in Plastic Box

Chuck and Tool Assortments

The chucks and tools in the assortments shown are recommended for use with the various South Bend Lathes. This is the basic equipment required for the average shop for general machine work, such as turning, boring, drilling, cutting-off, chucking, etc. A 3-jaw Universal chuck can be substituted for the 4-jaw Independent at additional cost.

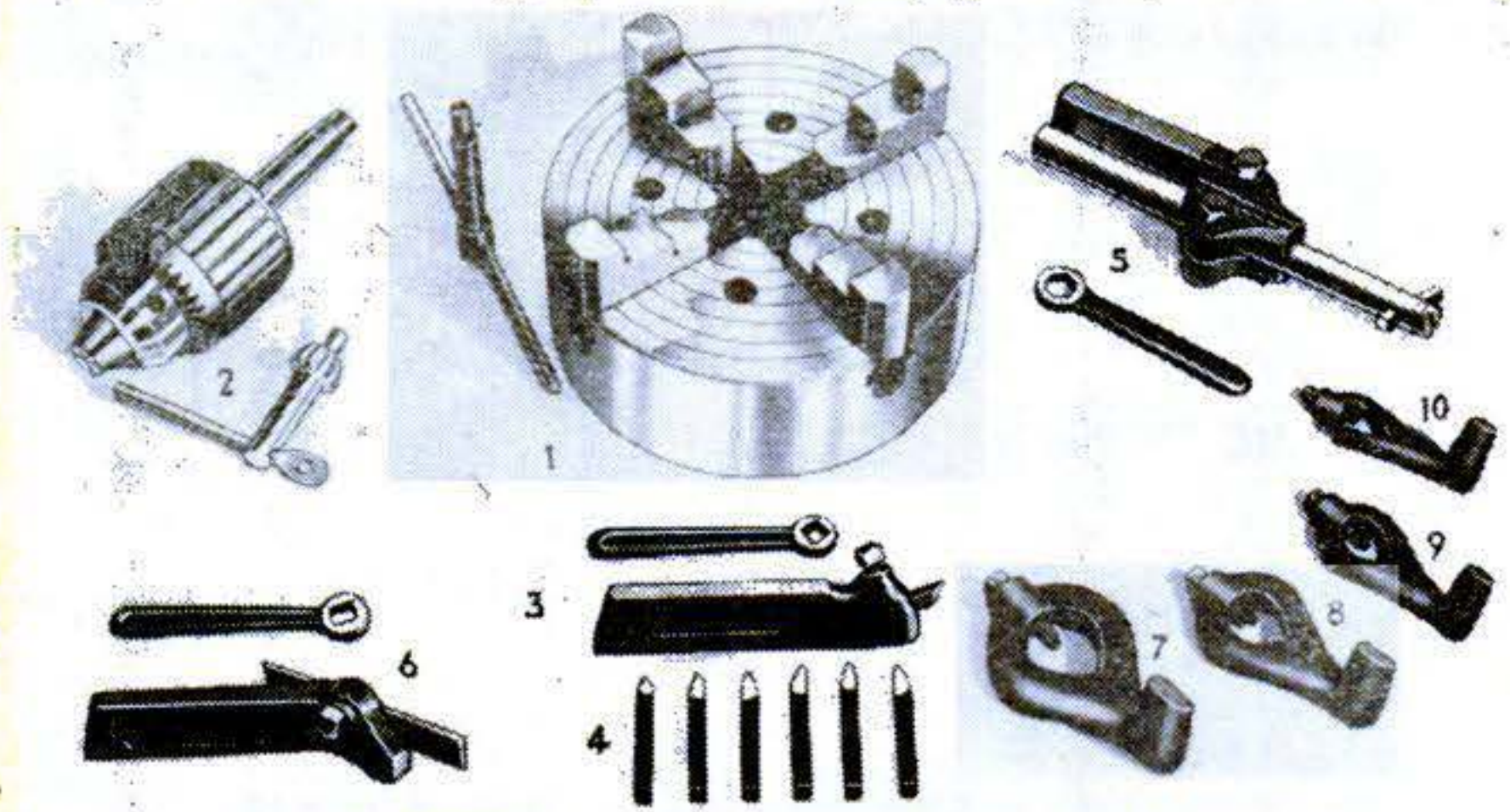

Contents of Assortment

- 4-Jaw Independent Lathe Chuck fitted to lathe. Sizes: 6 in. on 9" and 10" Lathes; 7½ in. on 13" Lathe; 9 in. on 14½" Lathe; 10 in. on 16" and 16/24" Lathes.
- Jacobs 3-Jaw Drill Chuck. Sizes: ½ in. on 9" and 10" Lathes; ¾ in. on 13" and 14½" Lathes; 1 in. on 16" and 16/24" Lathes.
- Arbor Fitted to Above Drill Chuck.
- Straight Shank Tool Holder.
- 6 Ground Cutter Bits for Tool Holder.
- Boring Tool Holder, Style "B." 9" Lathes take Style "D."
- Cutting-Off Tool Holder, Right-Hand.
- 4 Malleable Lathe Dogs. Sizes: ½", ¾", 1", and 1¼" on 9" and 10" Lathes; ½", ¾", 1", and 1½" on all others.

Prices of Complete Assortments

Size of Lathe	Catalog No.	Price
9" & 900.....	105-WT	\$53.44
10"—11/16" Collet.....	110-T	92.27
10"—1" Collet & 1000...	110-L	93.27
13".....	113-T	107.81
14½".....	114-T	121.58
16" & 16/24".....	116-T	141.88

Wood Turning Rest

Mounts on compound rest base to convert lathe for wood turning. See following pages for centers for wood turning.

Prices Start
At \$9

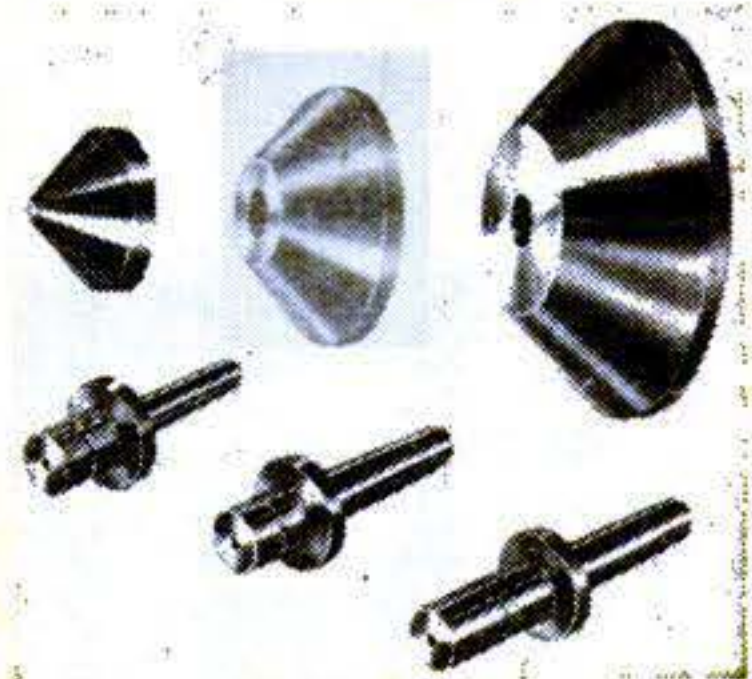
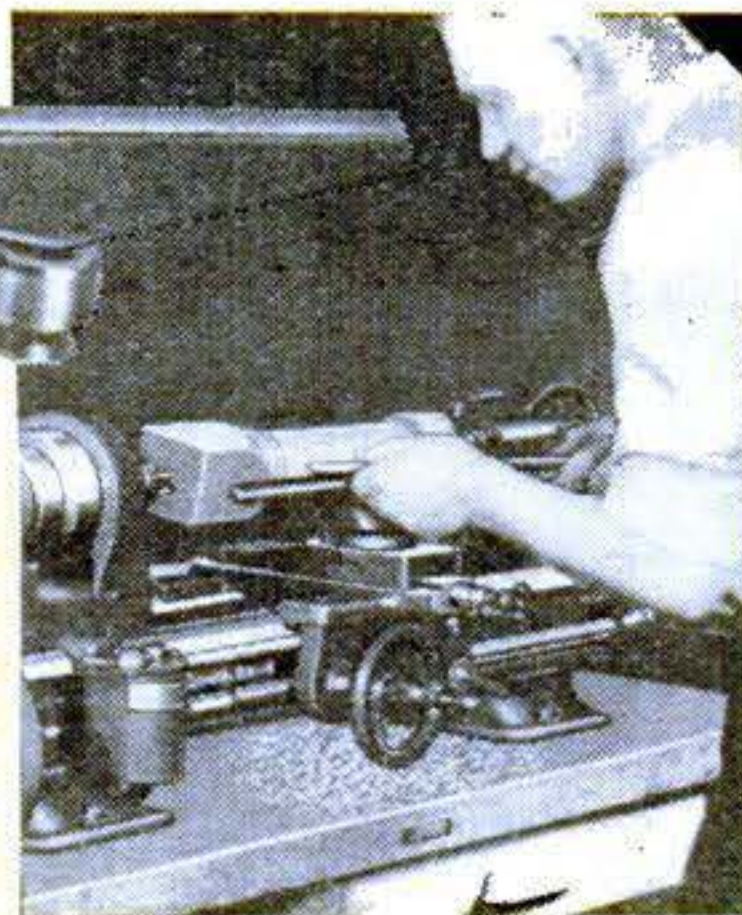

Pipe Centers

Cat. No.	Takes Pipe	Requires Shank	Price
2160	½" to 3"	2172-NR	\$4.50
2161	3" to 5"	2172-TH	6.00
2162	5" to 8"	2173-TH	9.00

Pipe Center Shanks

Cat. No.	Taper	Price
2172-NR	No. 2	\$4.50
2172-TH	No. 3	4.50
2173-TH	No. 3	7.50

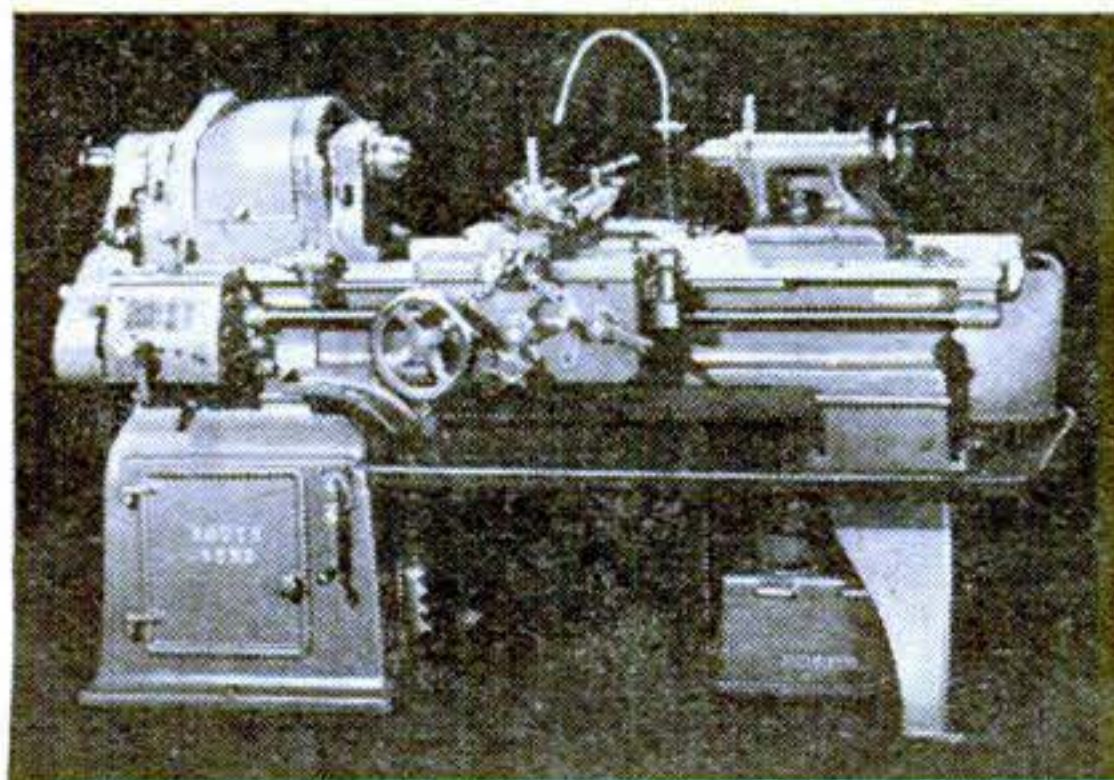

Chip Pans and Oil Pans

Oil Pans, Splash Pans, and Chip Pans can be supplied for all South Bend Lathes. Oil Pans should be factory-installed for proper fit. Complete information and prices will be supplied on request.

TIME PAYMENT TERMS

When order includes lathe 25 per cent down 12 months to pay balance Moderate finance charges

SOUTH BEND LATHE WORKS, 524 E. Madison Street, South Bend 22, Indiana, U.S.A.

Milling and Keyway Cutting Attachment

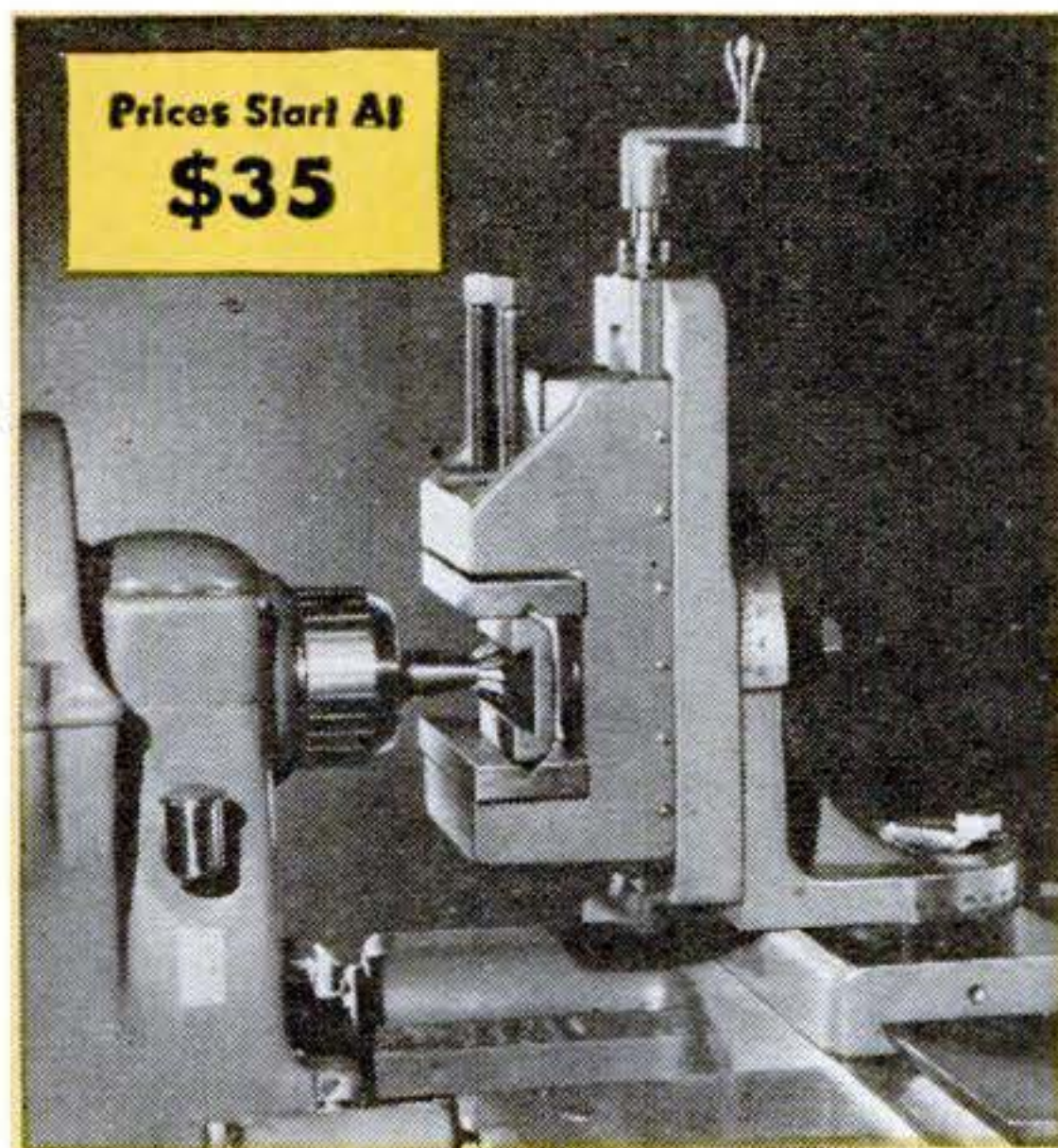

Milling and Keyway Cutting Attachment

This useful attachment is ideal for shops not having enough of this work to justify a milling machine. Mounts on compound rest base of lathe, permitting the power cross and longitudinal feeds to be used for milling, boring and keyway cutting operations on work held in the milling attachment vise. Vise swivels in any direction, 180° horizontal and vertical graduations. Vertical slide adjusting screw equipped with micrometer graduated collar.

Size Lathe	Cat. No.	Vise Cap.	Price
9" & 900	9-W	1 1/2"	\$35
10" & 1000	1-N	1 3/4"	45
13"	3	2 1/8"	55
14 1/2"	4-K	4"	65
16", 16/24"	5	4"	75

Arbors for Milling Cutters



Holds cutters with 1" holes. Capacity between nut and shoulder, 1 1/2". 3 spacing collars furnished. All shanks No. 3 Morse Taper.

Lathe Size	Catalog No.	Price
9" & 900	109-NH	\$7
10" & 1000	109-NH	7
13"	109-NH	7
14 1/2"	109-NH	7
16", 16/24"	109-NH	7

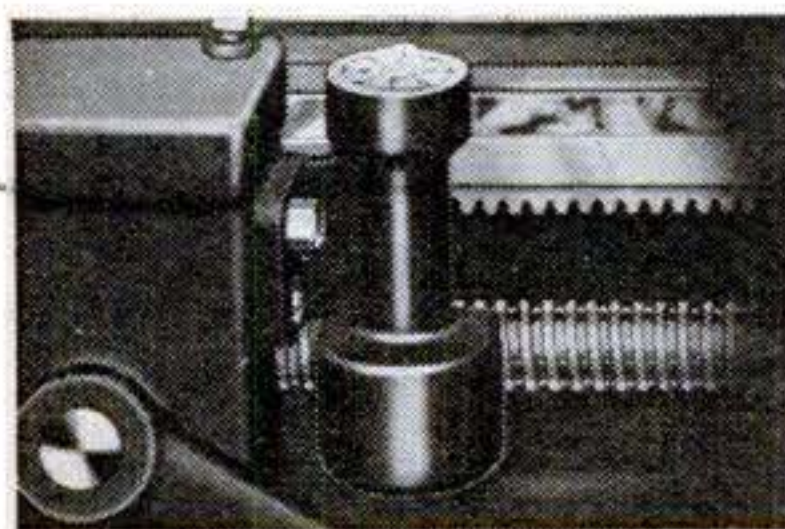

Thread Dial Indicator

Eliminates reversing of lathe spindle when cutting threads. Dial is numbered and graduated to show when to close half-nuts on lead screw to catch the thread on the next successive cut, after returning carriage to starting point.

Lathe Size	Catalog No.	Price
9" & 900	810-W	\$ 8
10" & 1000	1588	13
13"	813	15
14 1/2"	813	15
16", 16/24", 2-H	813	15

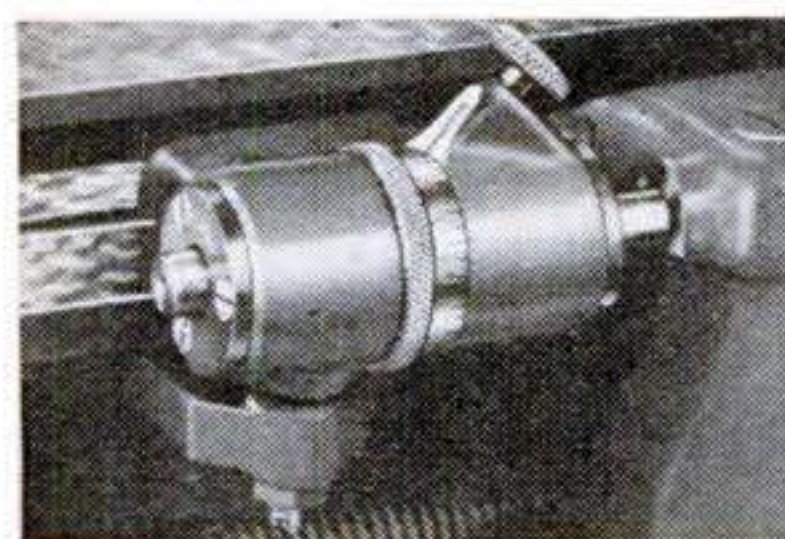

Micrometer Carriage Stop

Locates the carriage at any point along the bed for accurate facing, turning, boring, etc. Has accurately graduated micrometer collar. Stop is hardened on both ends for use on either side of carriage. Can be locked for duplicate work.

Size of Lathe	Catalog No.	Price
9" & 900	968-W	\$15
10" & 1000	1518	16
13"	973	18
14 1/2"	1502	19
16", 16/24", 2-H	975	19

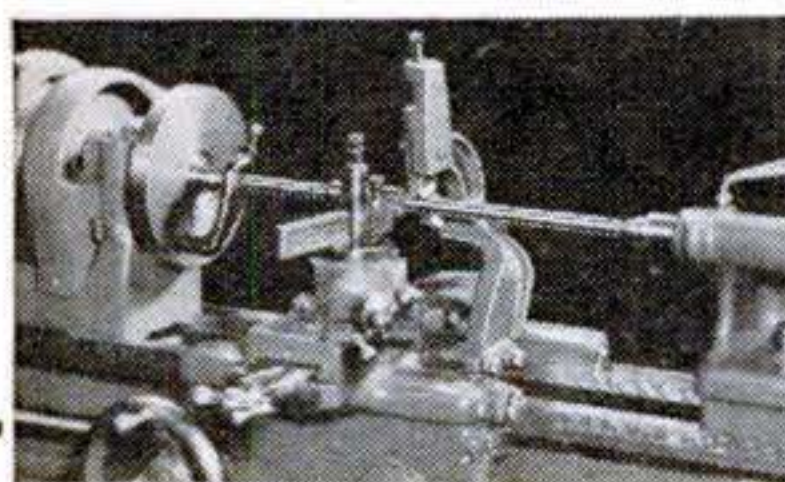

Follower Rest

Supports long, slender shafts being machined between centers. Attaches to, and travels with, the carriage. Adjusting screws and lock screws are provided for setting the jaws in position. Slots in bottom of follower rest permit quick attachment or removal.

Size of Lathe	Catalog No.	Capacity		Price
		Max.	Min.	
9" & 900	34-W	2"	3/16"	\$4.75
10" & 1000	1353	2 1/2"	3/16"	7.00
13"	376	3 1/4"	3/16"	8.00
14 1/2"	1351	4 1/4"	3/16"	9.00
16"	730	4 1/4"	3/16"	10.00
16/24"	1352	4 1/4"	3/16"	15.00

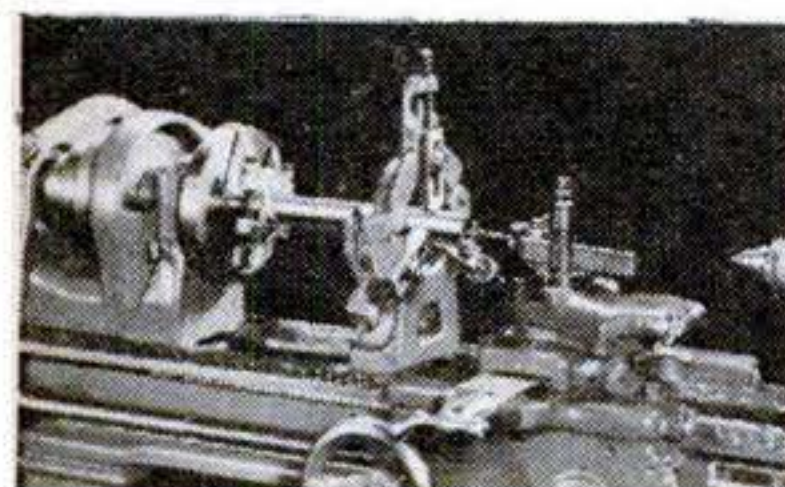

Center Rest

Clamps on inside ways of lathe bed and is used for supporting long shafts, boring spindles, etc. The 3 jaws are adjustable, and are made of cast iron. Top of center rest is hinged to facilitate inserting and removing shafts.

Size of Lathe	Catalog No.	Capacity		Price
		Max.	Min.	
9" & 900	125-W	3"	1/4"	\$ 7
10" & 1000	1177	3"	1/4"	10
13"	341	3 3/4"	3/8"	13
14 1/2"	1174	4 3/4"	3/8"	16
16"	720	4 3/4"	3/8"	18
16/24"	1175	4 3/4"	3/8"	24

Taper Attachments

Telescopic and Plain

Taper turning and boring are as easily accomplished as straight turning on lathes equipped with South Bend Taper Attachments. The Taper Attachments are permanently mounted on the lathe carriages, and must be fitted at the factory. Accuracy and smooth operation are assured by their practical design and rugged construction. The swivel bar is graduated in both degrees and taper per foot.

Telescopic Taper Attachments are used only on 10" and larger lathes. A telescopic cross-feed screw eliminates the necessity of disconnecting the cross-feed nut when tapers are machined. The Plain Taper Attachment used on 9" Lathes requires the disconnecting of the cross-feed screw and nut.

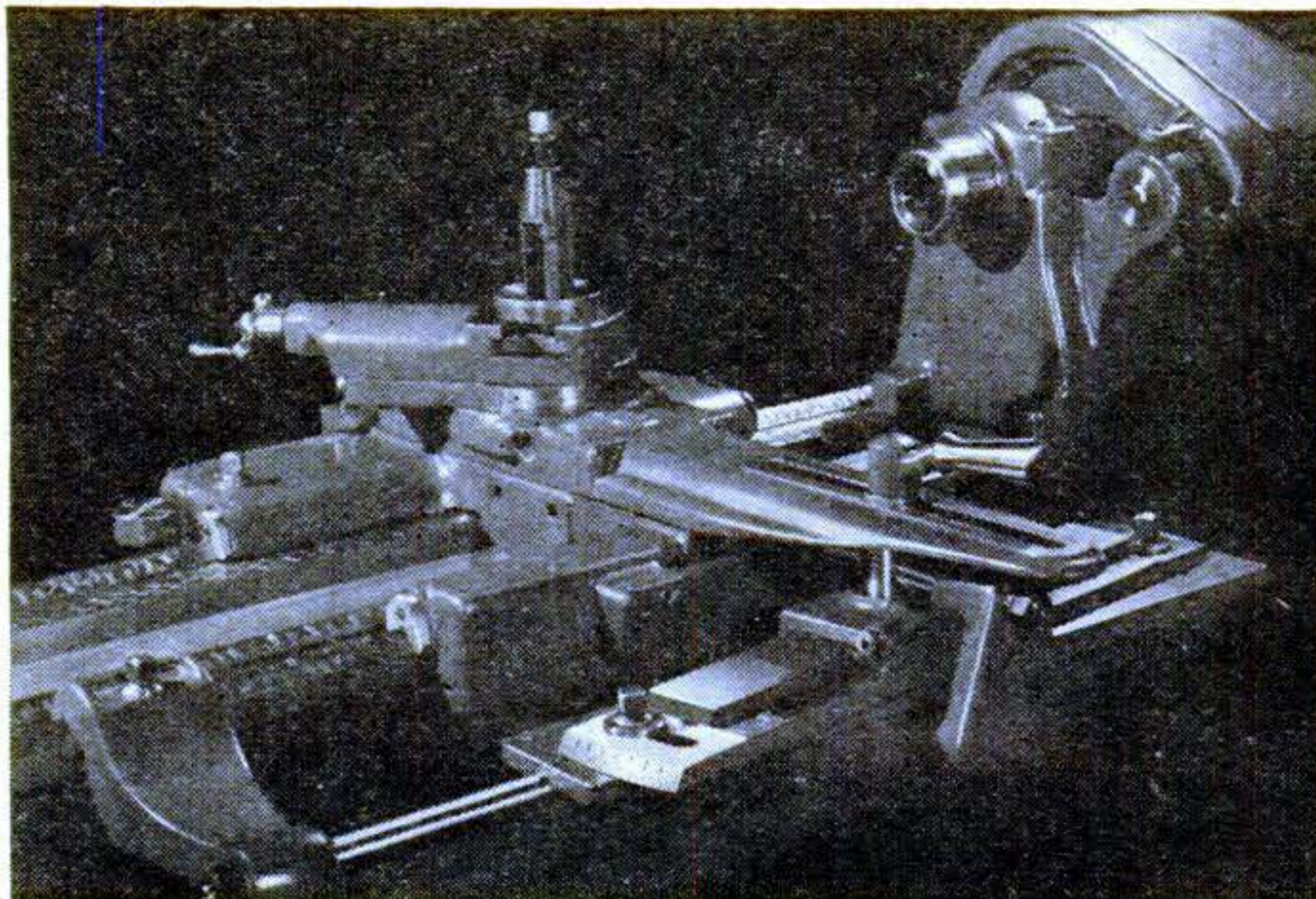

Telescopic Taper Attachment

Size of Lathe	Catalog Number	Max. Length at One Setting	Max. Taper per Foot	Max. Taper in Degrees	Price
9" and 900....	428-W	7"	3 1/2"	16 1/2"	\$ 75
10" & 1000....	1545	8 1/2"	3 1/2"	16 1/2"	137
13".....	379	9 1/4"	3 1/2"	16 1/2"	154
14 1/2".....	399	9 1/4"	3 1/2"	16 1/2"	165
16" & 16/24"..	381	11 1/2"	3 1/2"	16 1/2"	185

**TIME
PAYMENT
TERMS**

When order includes lathe
25 per cent down
12 months to pay
balance
Moderate finance charges

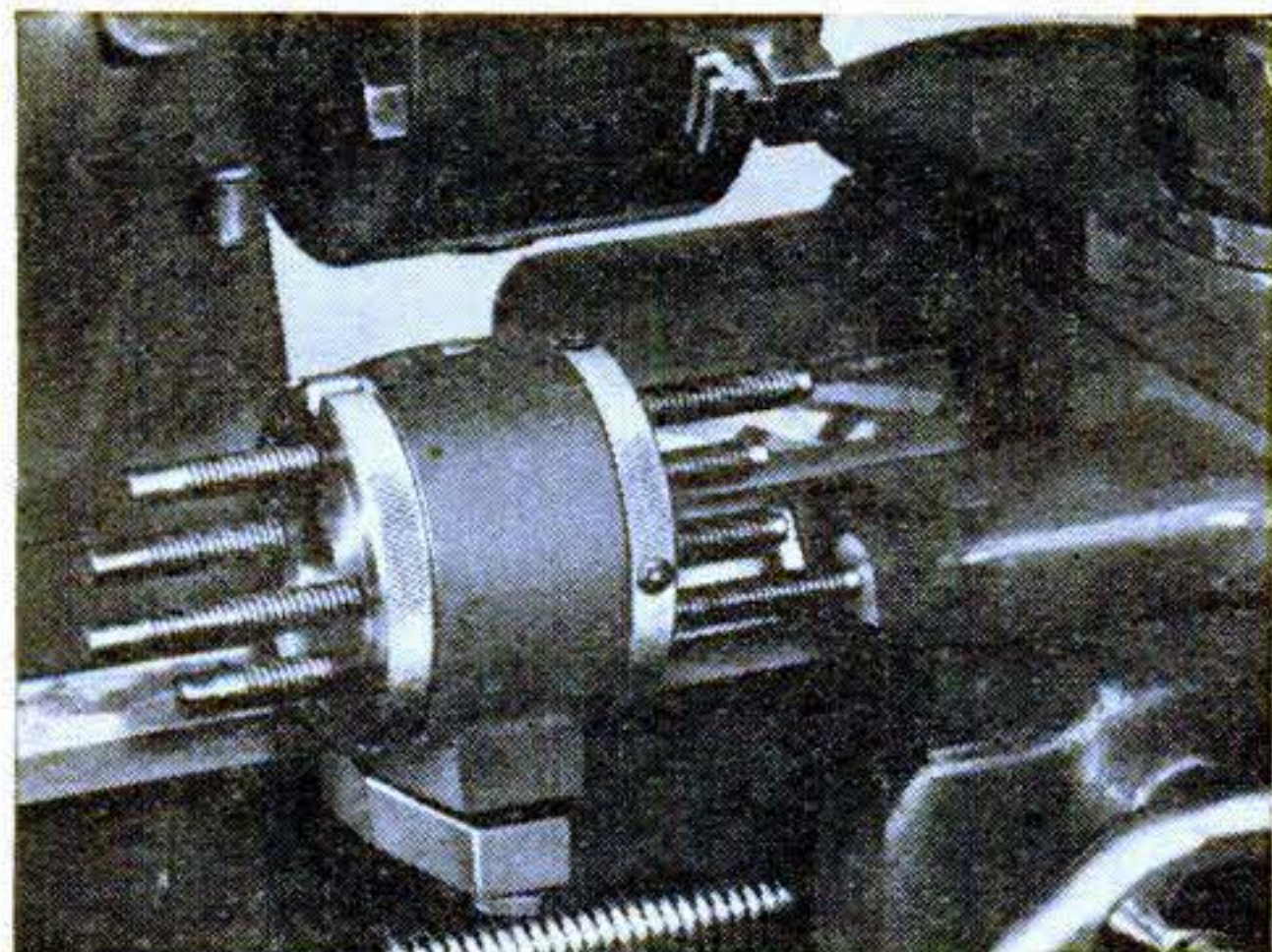

Four Position Carriage Stop

Much time can be saved in positioning the cutting tool for repetitive operations, by using this four position carriage stop. Each of the four adjustable stops may be set for a different tool position, and may be revolved to locate the carriage for each of four successive cuts. This attachment is especially desirable when a square turret tool block carrying up to four cutting tools is used. It may be clamped on either side of the carriage to position the tool either from left to right, or from right to left.

Cat. No.	Size Lathe	Price
2185-N	9".....	Price on Request
2185-R	10".....	
2185-T	13".....	
2185-F	14 1/2".....	
2185-H	16", 16/24", 2-H	

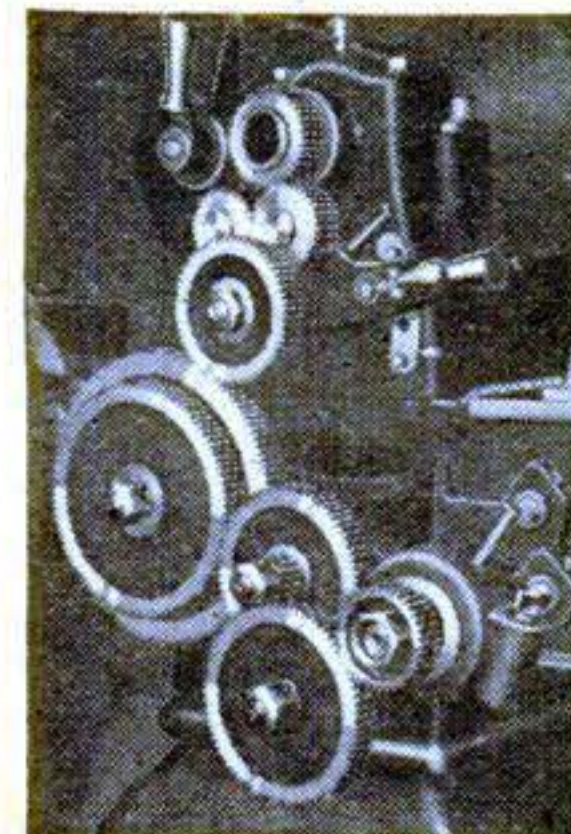

Metric Transposing Gears

Metric screw threads from 6 mm to 0.20 mm pitch (L.H. & R.H.) can be cut when Metric Transposing Gears are used. Prices when ordered with lathe.

Size of Lathe	Catalog No.	Price
Mdl. A 9" & 900...	1955-W	\$10
Mdl. B or C 9" & 900..	1759-W	12
10" & 1000.....	1963	40
13".....	1957	45
14 1/2".....	1961	50
16".....	1959	55
16/24".....	1960	50

SOUTH BEND LATHE WORKS, 524 E. Madison Street, South Bend 22, Indiana, U.S.A.

Universal Tool Block

The new Universal Tool Block replaces the conventional tool post and various tool holders ordinarily used for general lathe work. It provides rigid support for turning, boring, threading, and cut-off tool bits. In addition, it is equipped with a self-aligning knurling head. Screw adjustments for tool height are easily made, and they stay put. No re-adjustment is required when replacing tools. This tool block can be adapted to fit other makes of lathes.

Size of Lathe	Cat. No.	Price
9".....	1413-N	\$11.25
10".....	1413-R	11.75
13".....	1413-T	13.75
14 1/2".....	1413-F	15.75
16" & 16/24"	1413-H	16.25

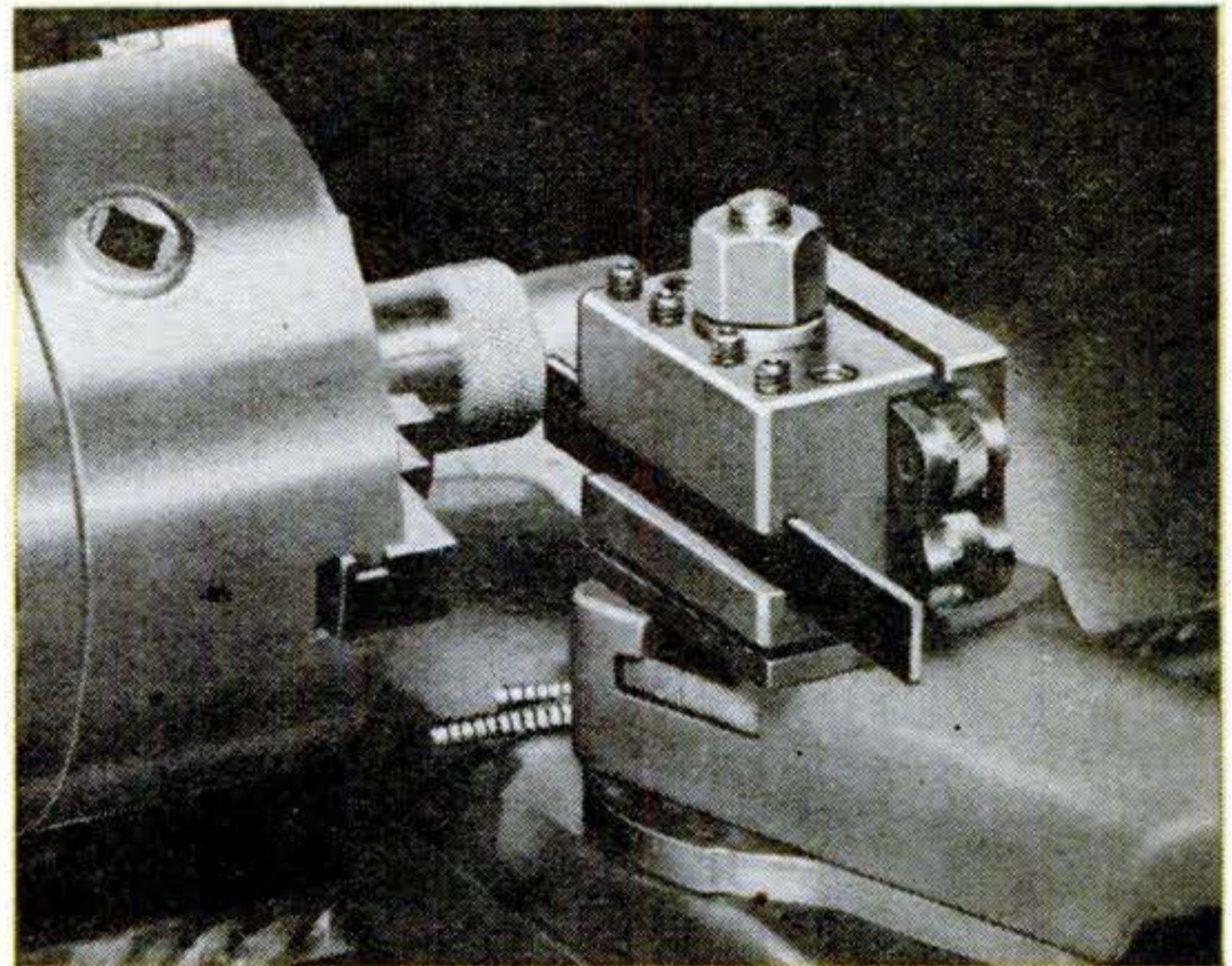

Universal Tool Block

Patent Pending

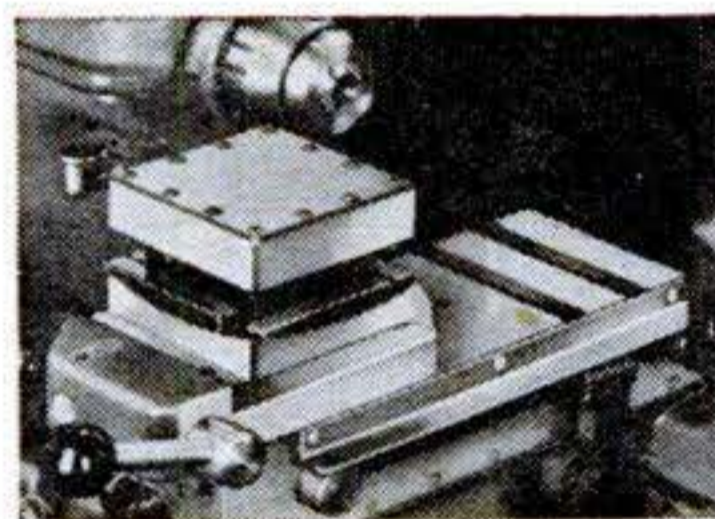

Patent Pending

Square Turret Tool Block

for Double Tool Cross Slide

The turret indexes within .0005", permitting each of four tools to be used in sequence for rough turning, finish turning, facing, boring, cutting-off, or other

operations as required. A quick-acting lever locks the turret securely in each of the four positions. Rocker adjustment is provided for adjusting height of each tool. For use on the double tool cross slides of South Bend Lathes, but can be adapted for use on other makes.



Patent Pending

Square Turret Tool Block

for Compound Cross Slide

Used on compound cross slides for same purpose as tool block described at left. Turret indexes within .0005" to each of four positions and

locks by means of lever. Rocker adjustments provided for tools. Ruggedly constructed. This tool block is for use on compound rest cross slides of South Bend Lathes but can be adapted for use on other makes.

Tool Blocks for Double Tool Cross Slides

Size of Lathe	Catalog Number	Size Square	Takes Tools	Price
9" & 900.....	41-ND	3"	3/8" x 3/8"	\$40
10" & 1000.....	41-ND	3"	3/8" x 3/8"	40
16".....	42-ND	4"	5/8" x 5/8"	70

Tool Blocks for Compound Cross Slides

Size of Lathe	Catalog Number	Size Square	Takes Tools	Price
9" & 900.....	40-NC	3"	3/8" x 3/8"	\$45
10" & 1000.....	41-NC	3"	3/8" x 3/8"	45
13".....	43-NC	3"	3/8" x 3/8"	50
14 1/2".....	44-NC	4"	5/8" x 5/8"	70
16" & 16/24".....	42-NC	4"	5/8" x 5/8"	75

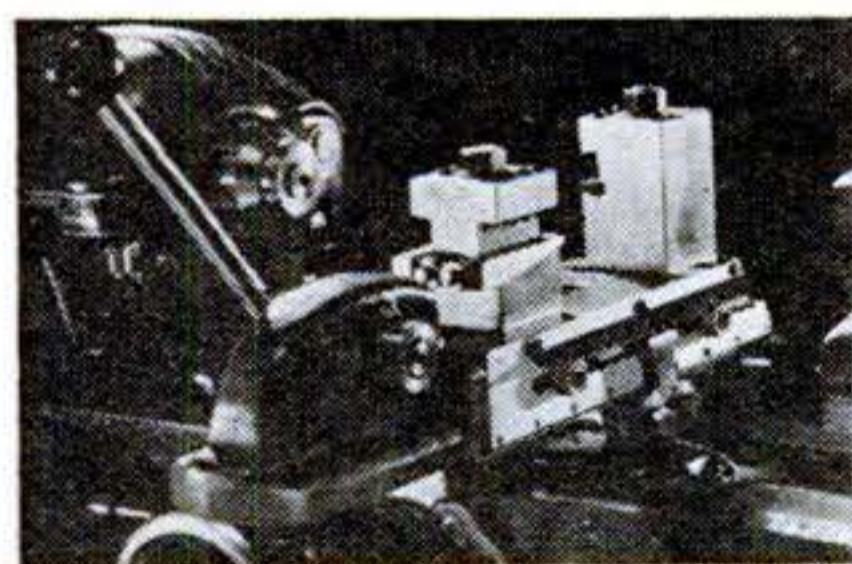

Size of Lathe	Catalog Number	Swing over Slide	Price
9" & 900..	2030-W	3-9/16"	\$75
10" & 1000.	2031	3-9/16"	90

Handlever Double Tool Cross Slide

Ideal for increasing production on repetitive operations. Three 7/16" square cutter bits can be used—two in front tool block, one in rear tool block. Mounts on saddle cross slide in place of compound rest. Can be operated by handlever or power cross-feed.

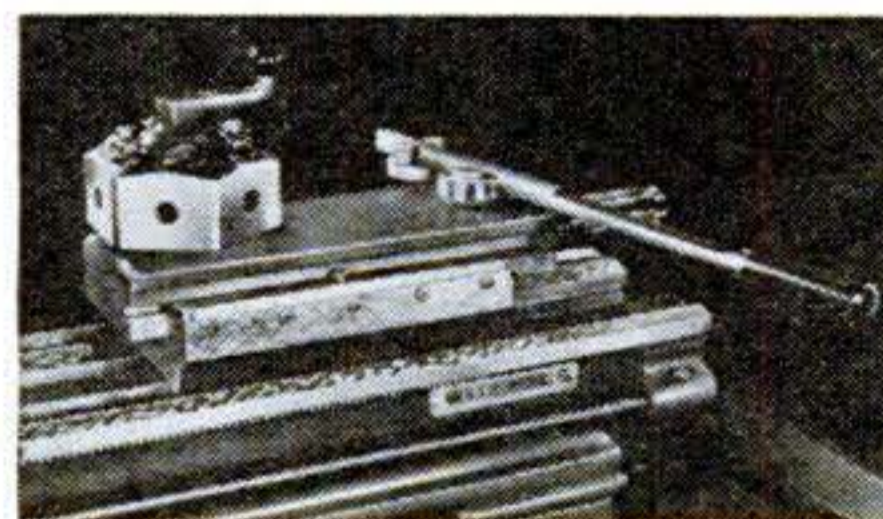

Size of Lathe	Cat. No.	Price
9" & 900.....	1611-W	\$200
10" & 1000....	1612	210
13".....	1613	225

Handlever Bed Turret

Turret head indexes automatically when lever is moved to extreme right. Each turret face has independently adjustable feed stop screw which accurately regulates length of cut. Effective feed of turret slide 4". Turret indexes within .0005" four inches from turret face.

SOUTH BEND LATHE WORKS, 524 E. Madison Street, South Bend 22, Indiana, U. S. A.

Standard and Safety Lathe Dogs

Lathe dogs should correspond in capacity to the diameter of the work if the work is to be held securely. These lathe dogs are made of heavy malleable iron and are properly designed for maximum strength and long service. The Standard Lathe Dog has square head alloy steel set screw. The Safety Lathe Dog has a headless alloy steel set screw.



Lathe Dogs for 13" and Larger Lathes

Cap. In.	STANDARD		SAFETY		
	Cat. No.	Price	Cat. No.	Wrench Required	Price
1/2	3843	\$0.80	3826	2385	\$0.80
3/4	3844	.95	3827	2386	.95
1	3845	1.05	3828	2387	1.05
1 1/4	3846	1.20	3829	2388	1.20
1 1/2	3847	1.40	3830	2389	1.40
1 3/4	3848	1.55	3831	2389	1.55
2	3849	1.70	3832	2389	1.70
2 1/2	3850	1.95	3833	2390	1.95
3	3851	2.20	3834	2390	2.20
3 1/2	3852	3.00	3835	2390	3.00
4	3853	4.00	3836	2390	4.00

Lathe Dogs for 9" and 10" Lathes

Cap. In.	STANDARD		SAFETY		
	Cat. No.	Price	Cat. No.	Wrench Required	Price
3/8	3837	\$0.70	3820	2385	\$0.70
1/2	3838	.75	3821	2385	.75
3/4	3839	.90	3822	2386	.90
1	3840	1.00	3823	2387	1.00
1 1/4	3841	1.10	3824	2388	1.10
1 1/2	3842	1.35	3825	2388	1.35

A complete set of lathe dogs is a must in any shop.

Lathe Centers and Drill Pads

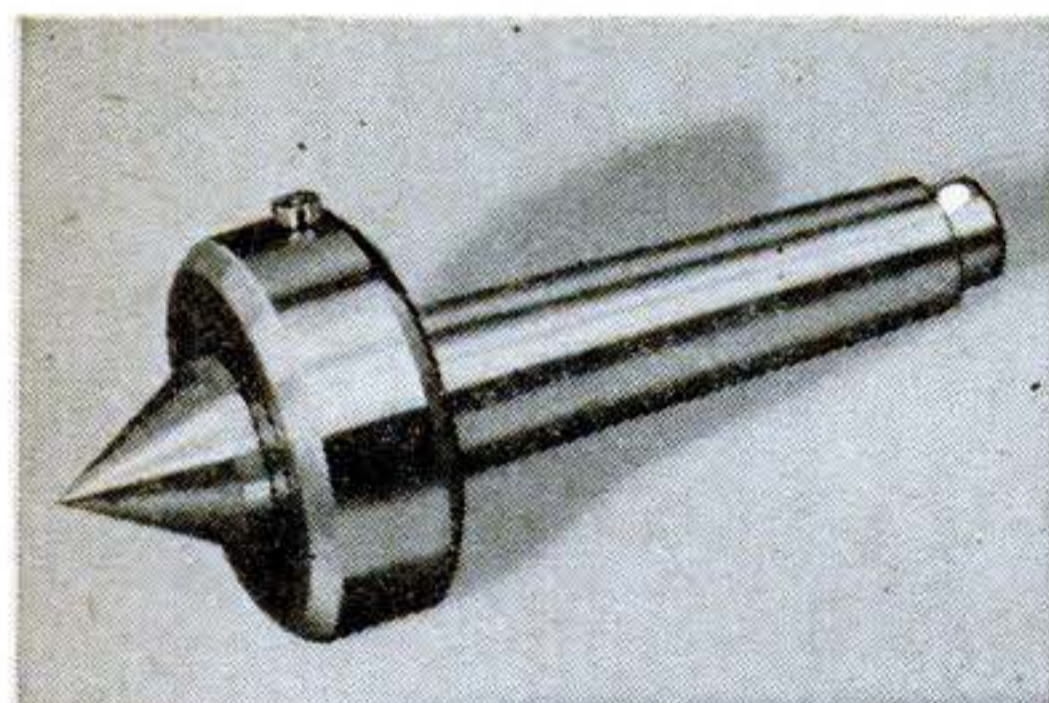

Patent Pending

Ball Bearing Live Center

Designed for maximum strength and rigidity, the Ball Bearing Live Center is recommended for high speeds, heavy roughing cuts, etc. 60° point runs in substantial precision ball bearing which is easily replaceable.

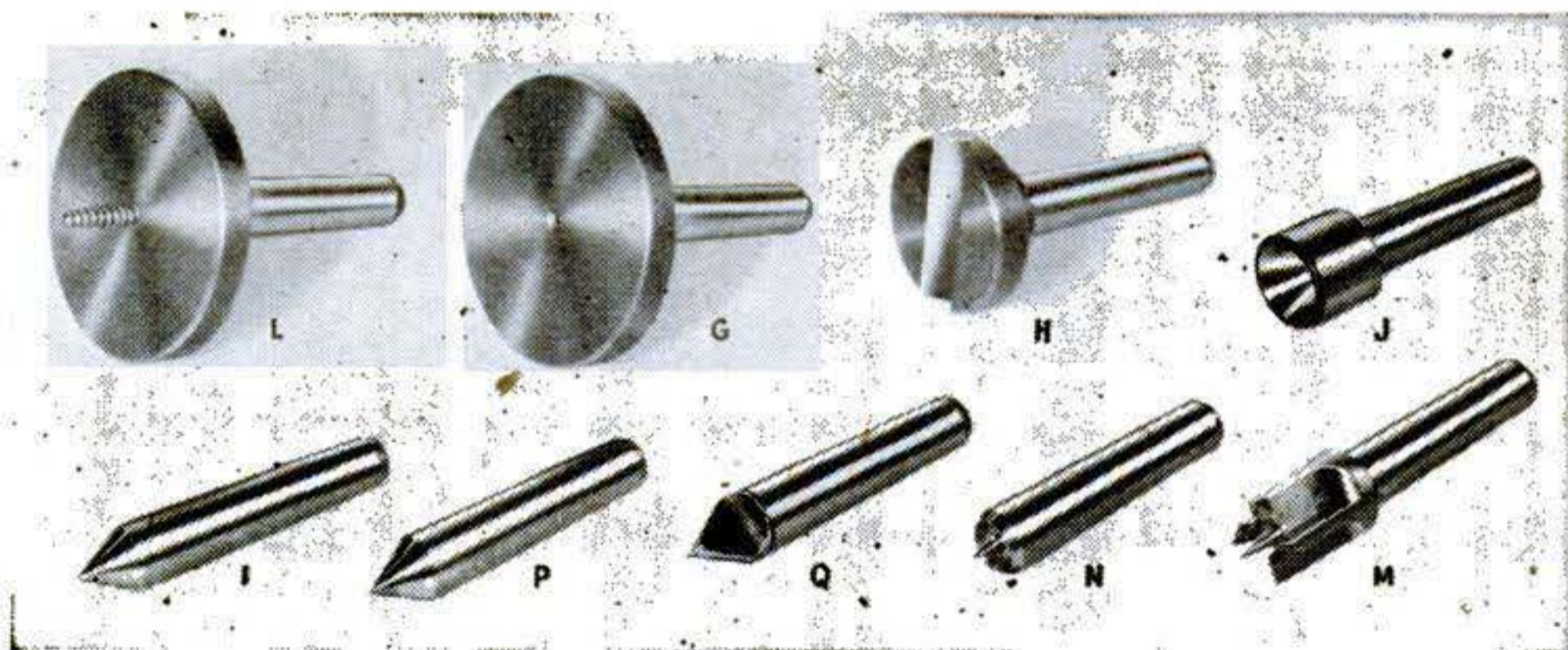

L—Screw Center for wood turning. G—Drill Pad to support flat work for drilling. H—Crotch Center supports round work for cross drilling. J—Hollow Center for supporting centerless shafts up to 7/8" dia. I—60° Center for headstock or tailstock spindles P—Carbide Center. Q—Half Center. N—Cup Center. M—Spur Center, for all wood turning operations.

Catalog No.	Shank Taper	Price	Description	No. 2 Taper for 9" and 10" Lathes		No. 3 Taper for 13", 14 1/2", & 16"	
				Cat. No.	Price	Cat. No.	Price
3900	No. 2	\$11.50	L—Screw Center.....	731-NR	\$3.00	731-TH	\$3.25
3901	No. 3	13.50	G—Drill Pad.....	727-NR	2.50	727-TH	2.75
			H—Crotch Center.....	728-NR	2.50	728-TH	3.25
			J—Hollow Center.....	1896-NR	2.00	1896-TH	2.75
			I—60° Center.....	726-NR	2.25	726-TH	3.00
			P—Carbide Center.....	1889	4.50	1890	8.00
			Q—Half Center.....	926-NR	2.25	926-TH	3.00
			N—Cup Center.....	733-NR	2.00	733-TH	2.75
			M—Spur Center.....	732-NR	3.00	732-TH	3.25

TIME PAYMENT TERMS

When order includes lathe
25 per cent down
12 months to pay balance
Moderate finance charges

SOUTH BEND LATHE WORKS, 524 E. Madison Street, South Bend 22, Indiana, U.S.A.

Coolant Pump and Reservoir

(Not Fitted to Lathe at Factory)

The coolant equipment listed below includes motor driven coolant pump, tubing, reservoir and tray, 1/4 h.p. motor (see table below), switch, and wiring for connecting switch to motor. Pump is self-priming as it is below the oil level. Reservoir intake is fitted with large filter screen. This coolant equipment can be used with lathes and other machine tools. When ordering, specify voltage, phase, and cycle of motor wanted.

Cat. No.	Motor Specifications				Price
	Current	Phase	Cycle	Voltage	
2003-C	A.C.	3	50	220	\$117.00
2003-D	A.C.	3	60	220	117.00
2003-E	A.C.	3	50	440	117.00
2003-F	A.C.	3	60	440	117.00
2001-A	A.C.	1	50	115	105.00
2001-B	A.C.	1	60	115	103.00
2001-C	A.C.	1	50	230	106.00
2001-D	A.C.	1	60	230	105.00
2000-K	D.C.	115	128.00
2000-L	D.C.	230	128.00

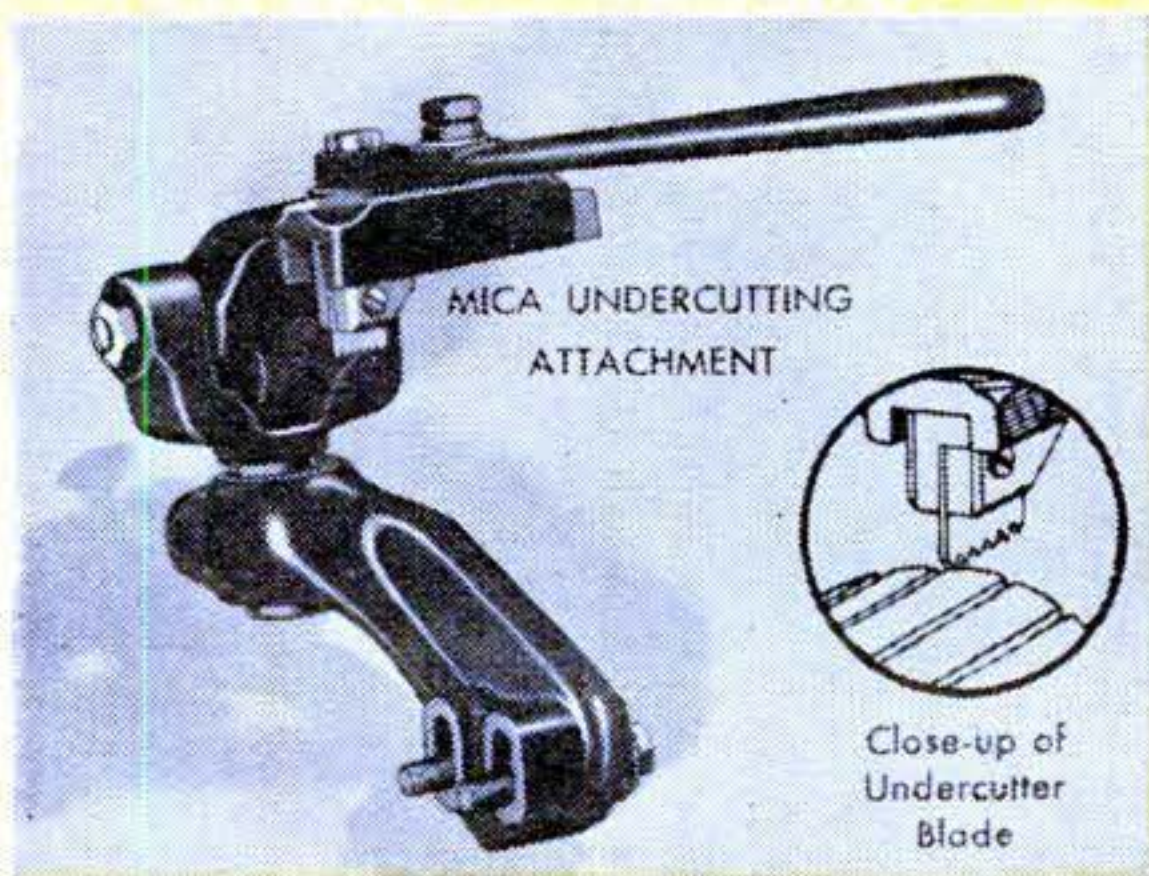
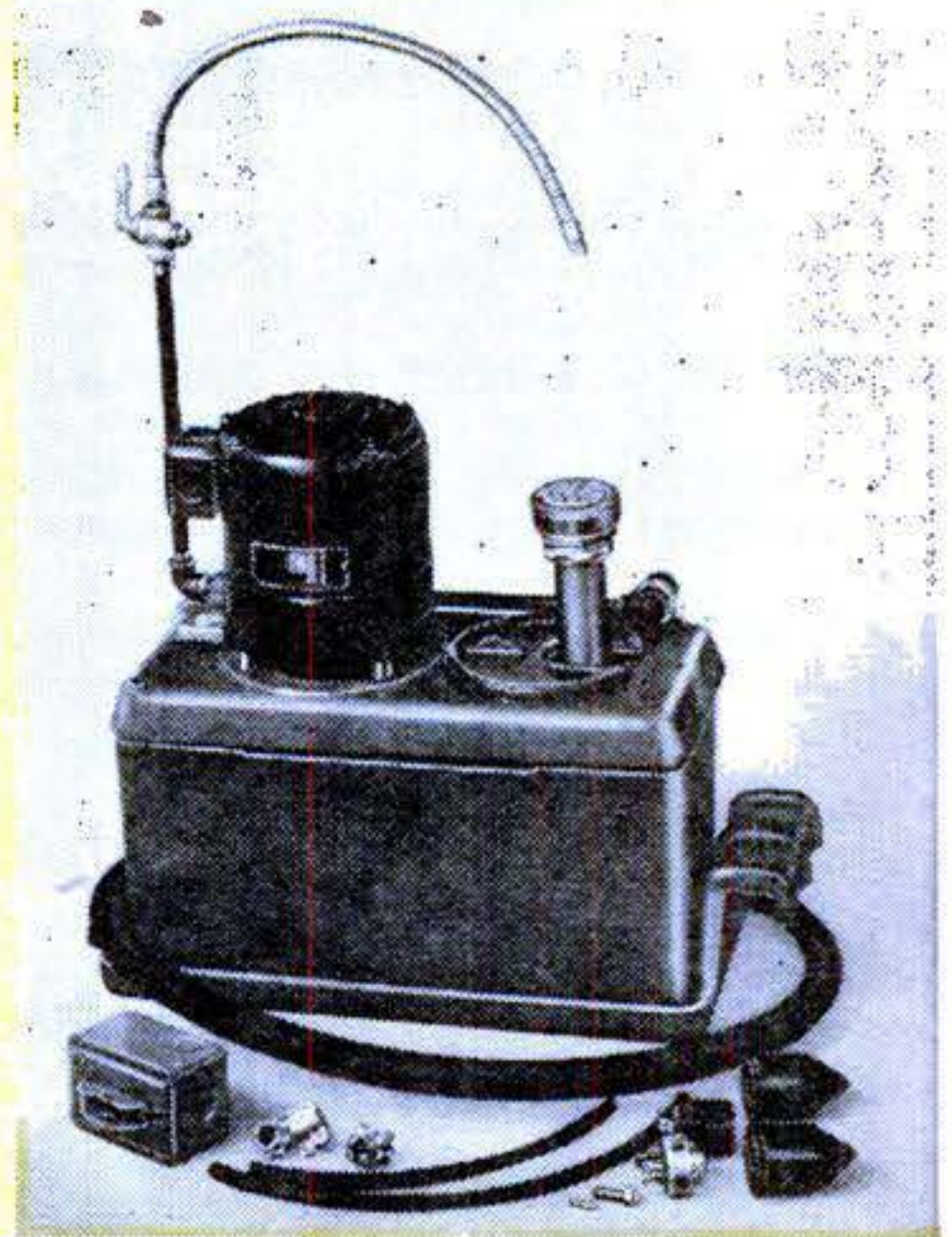

Mica Undercutting Attachment

Any shop that repairs armatures for motors, generators or starters will have a lot of use for this practical attachment. It attaches to the saddle of the lathe which insures rigidity and alignment. The blade travels parallel to the commutator bars which insures clean, straight cutting. Upper portion is hinged so the blade holder can be swung back so it does not interfere with turning the commutator.

Price includes one blade .020" thick. Extra cutter blades .020" and .015" thick are available as listed below.

Patented

Size of Lathe	9"		10"		13"		14 1/2"		16"	
	Description	Cat. No.	Price	Cat. No.	Price	Cat. No.	Price	Cat. No.	Price	Cat. No.
Mica Undercutting Attachment.....	675-N	\$18.00	675-R	\$18.00	675-T	\$19.00	675-F	\$20.00	675-H	\$21.00
Extra Blade, .015".....	2028	.15	2028	.15	2028	.15	2028	.15	2028	.15
Extra Blade, .020".....	2029	.25	2029	.25	2029	.25	2029	.25	2029	.25

Adjustable Collet Bushing Chuck

The adjustable collet bushing chuck provides an extremely accurate, but inexpensive equipment for mounting centerless armature shafts, and similar parts, in the lathe. Can be used in either head or tail spindle of lathe. Collets are made of brass, and may be adjusted for either running fit or driving fit on shaft.

Description	Cat. No.	Shank	Price
Adjustable Collet Bushing Chuck Only.....	1615-NR	No. 2	\$6.25
	1615-TH	No. 3	6.75
Adjustable Collet Bushing Chuck with set of 3 collets, 9/16", 5/8" and .637" capacity for popular armatures.....	1608-NR	No. 2	8.95
	1608-TH	No. 3	9.45

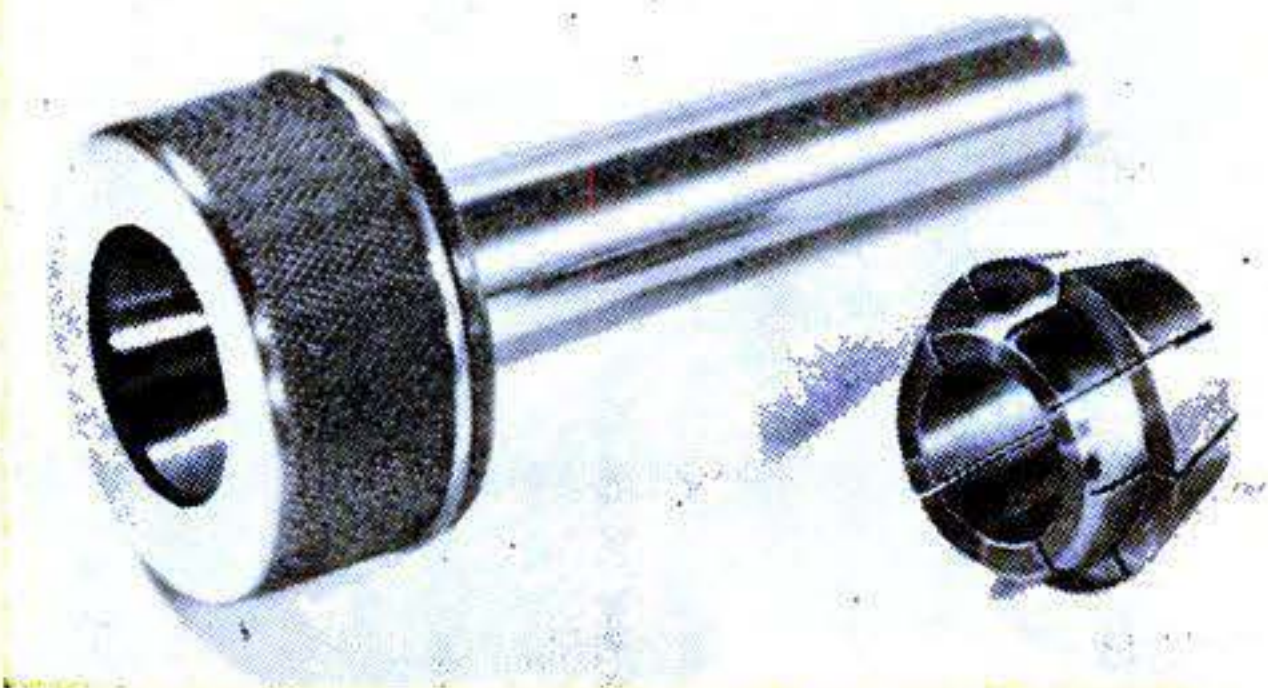

Cat. No. 1659, Extra Collets for round work, any capacity 1/4" to 1" round by 16ths, price each \$1.00.

SOUTH BEND LATHE WORKS, 524 E. Madison Street, South Bend 22, Indiana, U.S.A.

Two Superb Grinding Attachments

South Bend Design and Manufacture

External—This powerful and efficient grinding attachment is recommended for external grinding. Designed to fit the various sizes of South Bend Lathes, it is easily adaptable for use on milling machines, shapers, planers, or other makes of lathes. The spindle revolves on pre-lubricated, precision ball bearings which are sealed to protect them from damage by dust, grit and metal particles produced when grinding. Supplied with $\frac{1}{4}$ h.p., 1725 r.p.m. constant speed continuous duty motor, 4" x $\frac{1}{2}$ " grinding wheel.

Internal—Designed as a companion to the External Grinding Attachment, this grinder is intended for all types of internal grinding. It is equipped with a $\frac{1}{8}$ h.p. constant speed continuous duty motor. Spindle runs in precision ball bearings. Changeable pulleys provide 3 spindle speeds of approximately 13,000, 15,000, and 18,000 r.p.m. Uses standard Norton and Carborundum grinding wheels. Extension quill permits grinding holes up to 2 $\frac{1}{4}$ " deep. Price includes belt and three assorted grinding wheels.

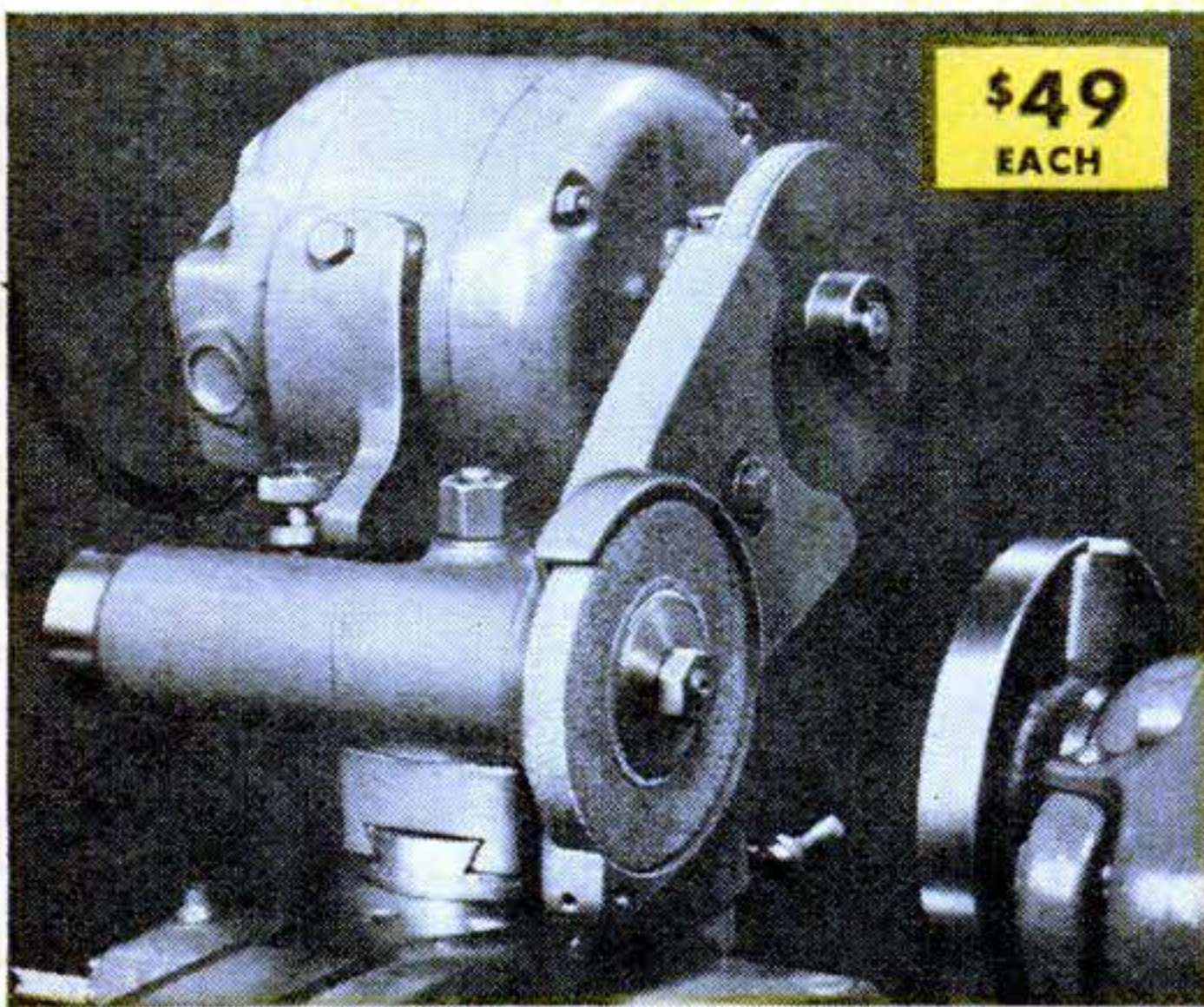

External Grinding Attachment

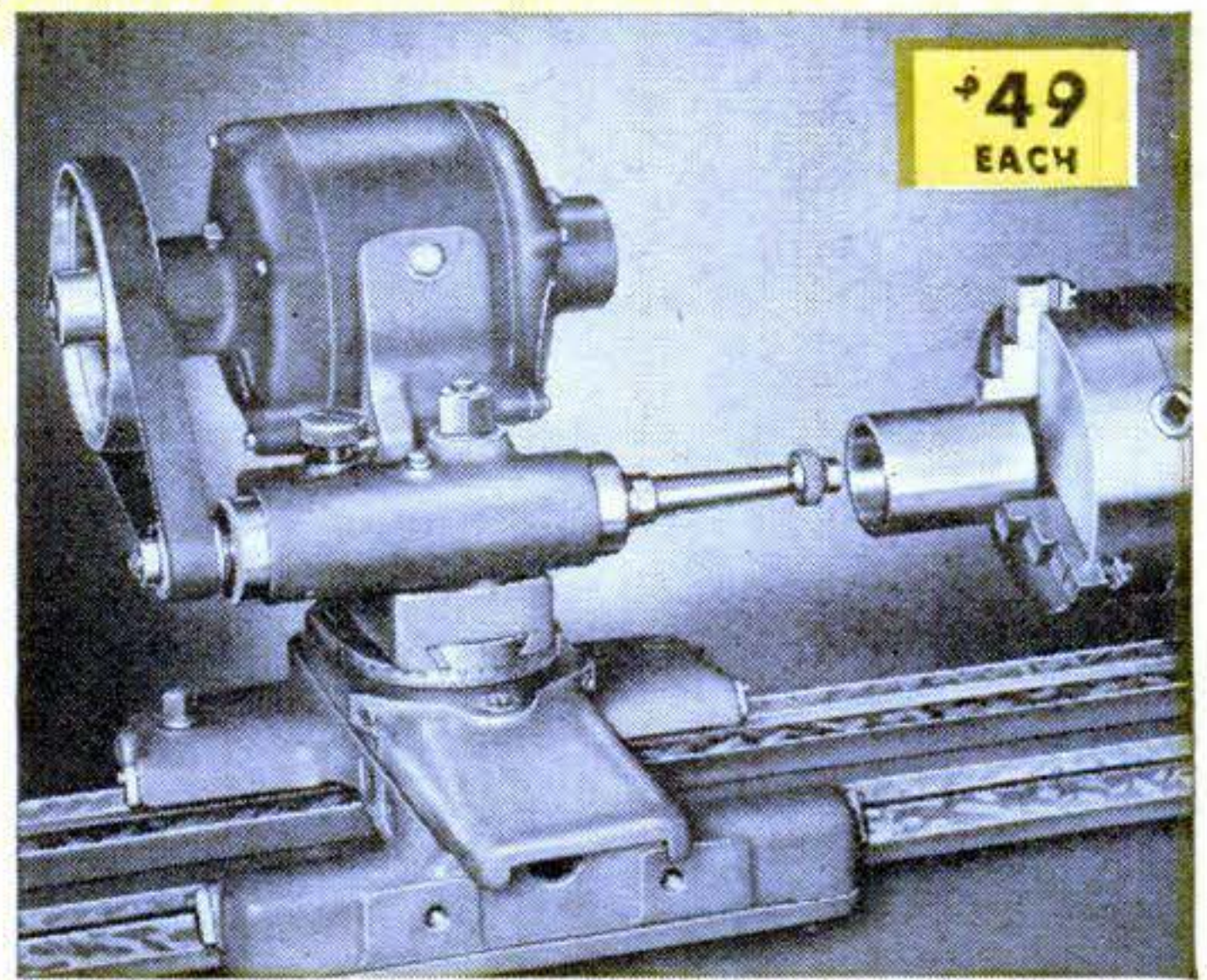

Internal Grinding Attachment

Prices include motor for 115 v., 60 cy., 1 ph., A.C. current.
Prices with other motors quoted on request.

TIME PAYMENT TERMS

When order includes lathe
25 per cent down
12 months to pay balance
moderate finance charges

Size of Lathe	EXTERNAL GRINDER		INTERNAL GRINDER	
	Catalog No.	Price	Catalog No.	Price
9" & Series 900.....	301-BN	\$49	201-BN	\$49
10"—11/16" Col.....	301-BR	49	201-BR	49
10"—1" Col. & 1000.....	301-BR	49	201-BR	49
13".....	301-BT	49	201-BT	49
14 $\frac{1}{2}$ ".....	301-BF	49	201-BF	49
16" & 16/24".....	301-BH	49	201-BH	49

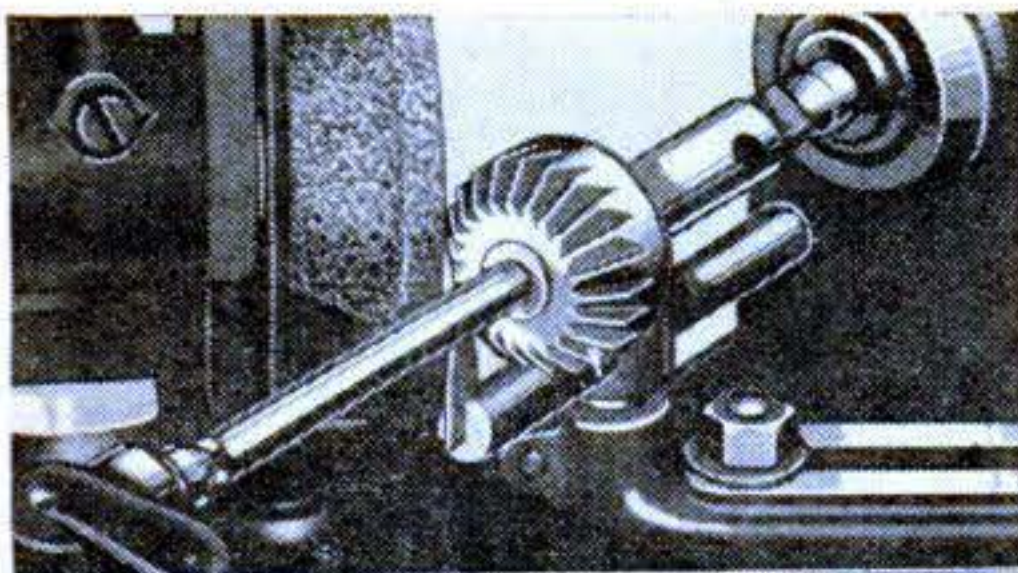

Above: Grinding a cutter with spring stop in holding fixture. Right: Grinding spiral reamer.

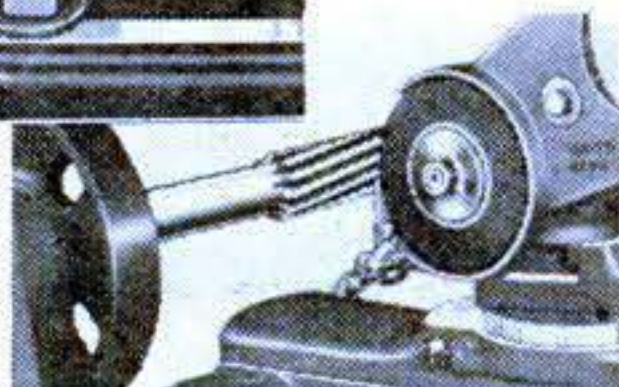

Reamer and Cutter Grinding Stops

Consists of adjustable holding fixture which clamps on lathe bed for holding adjustable grinding stops and diamond dresser for grinding wheels. Also a grinding stop which attaches to grinding wheel guard and travels with grinder for grinding spiral reamers and cutters.

Size of Lathe	9" Ser. 900	10" Ser. 1000	13"	14 $\frac{1}{2}$ "	16"	16/24"
Catalog No.....	1512-N	1512-R	1512-T	1512-F	1512-H	1512-V
Price.....	\$15	\$16	\$18	\$20	\$20	\$29

SOUTH BEND LATHE WORKS, 524 E. Madison Street, South Bend 22, Indiana, U. S. A.

AMAZING NEW SAFE MAGNETIC JIG SAW

READY for CHRISTMAS DELIVERY!

No. 2000

SYNCRO

DELUXE JIG SAW

\$17.50

FOB
Factory

Shpg. Wt. 18 lbs.

Prices slightly higher
in foreign countries.

For Hobbyists, Craftsmen, Light Production

GREATEST CLEARANCE, LARGEST TABLE TOP, MOST
POWERFUL—OF ANY MAGNETIC SAW MADE!

15 BIG FEATURES

(1) WORLD'S SAFEST SAW. (2) PORTABLE . . . plugs into 50 or 60 cycle A.C. only 110-120 volt wall outlet. (3) NO ROTATING MOTOR NEEDED. Syncro's self-contained magnetic power unit transmits A.C. magnetic impulses to armature diaphragm—power transferred to saw blade. COIL wire, impregnated, baked. Guaranteed not to burn out! DIAPHRAGM of spring steel, heat-treated under special process, suspended on L-I-V-E rubber mounting cartridges. (4) 14,400 STROKES PER MINUTE! (5) NO RECIPROCATING OR ROTATING PARTS TO WEAR OUT! (6) NEVER NEEDS OILING. (7) TABLE TOP 10" x 10". Largest magnetic jig saw table top made; heavy, thick, durable alloy die casting 1/8" thick, ribbed base. Surface smooth for easy sliding. Specially finished in 1/2" cross sectional engraved lines to assist in accurate cutting. (8) BASE 7 1/2" x 6 3/4" . . . a heavy, durable die casting. (9) ARM is of specially formed steel stamping 1/8" x 1". Return Spring of heavy duty steel. Guide Slide of plated steel and adjustable to vary-



FAMILY SAW

"The SYNCRO POWER SAW ordered from you in 1940 is still sawing merrily away. My son (then 8) has used it in the attic, kitchen, his room, and basement shop. I use it too. We never worry about accidents due to its MAGNETIC SAFETY STROKE feature. It's truly a family saw." Mr. B. H. Smith, Peabody Idaho.

SAFE!

SYNCRO has No continuous cutting blade nor "Long stroke" blade to pull fingers into teeth—instead there are 14,400 strokes per minute—2,000 short cutting strokes plus 7,200 upward NON-CUTTING, REPELLING strokes. (Fig. 1) SYNCRO will not even CUT wood unless blade is pushed FIRMLY DOWNWARD AGAINST wood and FIRMLY FORWARD—both actions at SAME time! SYNCRO blade teeth bite ONLY on DOWN stroke. (Fig. 2) Teeth raise, repel, push away any object on UP stroke. (Fig. 3) When blade moves UP, KICKS finger away. On down stroke, blade does not move enough to accidentally cut finger unless finger is intentionally, deliberately fed into blade like wood is fed in Figure 1. No wonder SYNCRO is the world's SAFEST saw . . . a mature old and youngers acclaim!

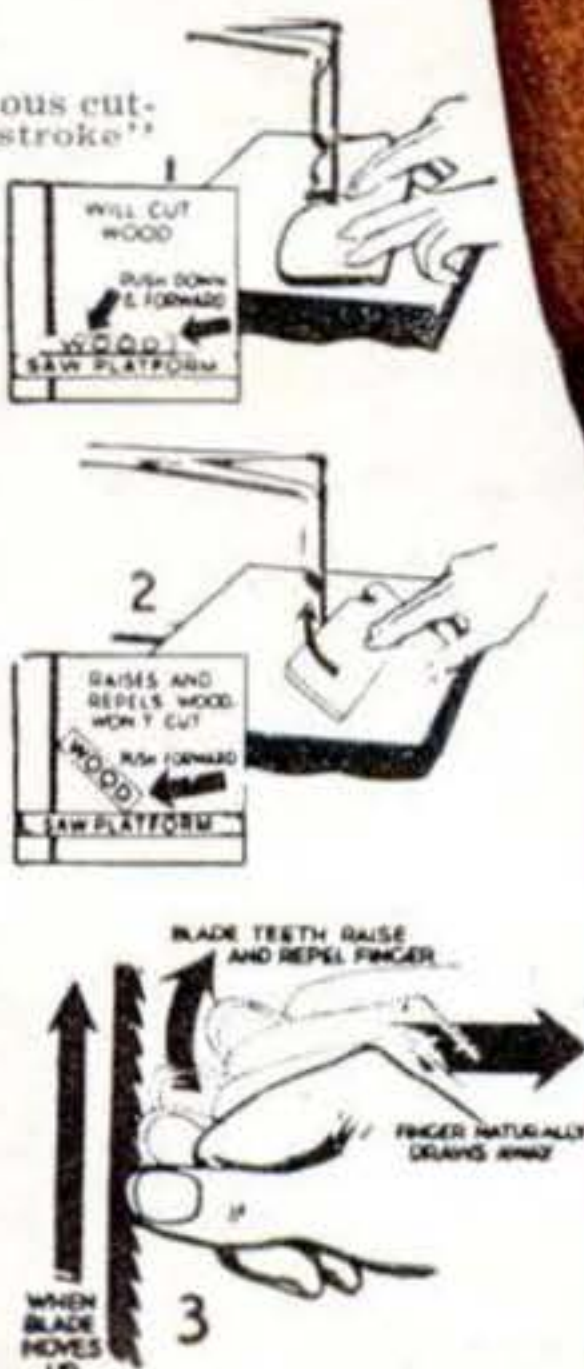

HOW TO ORDER—DO IT NOW!

Mail coupon with Postal Note, Money Order or check for only \$17.50 plus Parcel Post or Express carrying charges . . . or . . . send \$17.50 only and we will ship saw collect for Parcel Post or Express carrying charges only. Specify type of delivery on Coupon. Shipping weight, packed, 18 lbs. Hurry! Act promptly—order—we'll ship same day order is received. (No complete COD orders accepted.)

SYNCRO

WORLD'S SAFEST SAW

SAW CORPORATION, DEPT. B-127
ROCHESTER, MICHIGAN
Export Address: 120 Wall St., N.Y.C.

Com
with
3 bla

ing wood thick-
nesses. Adjustment
Screw permits easy,
quick changes to com-
pensate for voltages of 110
to 120 A.C. (10) THROAT
CLEARANCE 13 1/2" (greatest
clearance of any magnetic jig saw
made) permitting work on square
sheet of wood, metal, plastic, 27" on the
diagonal. (11) 5' cord . . . extension Under-
writers' approved electric cable with molded
rubber plug. (12) BLADES are 5" pin end
style, of finest steel, 18 teeth per inch.
(13) NO-MAR, NON-SLIP RUBBER FEET.
(14) DURABLE—will last a lifetime. (15)
HIGHEST QUALITY—guaranteed by the
trademark name "SYNCRO".

NOW... LIGHT WHEN YOU NEED IT!

Ray-O-Vac leak proof batteries
stay fresh for years!*



© 1947 RAY-O-VAC COMPANY, MADISON, WIS.; WINNIPEG, MANITOBA.

Sealed in steel—for extra power and extra long life —and to get away from the leaking, corroding and sticking so common in old-fashioned batteries. *Guaranteed . . .* a new flashlight FREE, if yours is ever harmed by a Ray-O-Vac Leak Proof Battery.

*You can keep Ray-O-Vacs on hand knowing they'll be fresh when you're ready to use them.

Ask for Ray-O-Vac Leak Proofs

Buy Spares... they stay fresh